

Islington, Old Street, St Lukes
OLRCD

Box 2 File 1

B. PRIMARY CONTEXT RECORDS - LEVELS

SCAN PDF

FILMING INSTRUCTIONS

Submitter OASouth

No. of CD copies: 2

Headings

Site information

Line 1: [OASouth] County:[Greater London] Parish:[Islington] Site:[Old Street, St Lukes]

Site code[OLR00]

Line 2: Excavators name[A. Boyle]

Line 3:

Classification of material

Tick if present

Index to archive	
Introduction	
A:Final Report	
A:Publication Report	
B:Site Data – Text: Diary/Daybook/Fieldnotes	
B: Site Data – Text: General Summaries	
B: Site Data – Text: Primary Context Records – LEVELS	✓
B: Site Data – Text: Synthesised Context Records	
B: Site Data – Text: Survey Reports	
B: Site Data – Text: Catalogue of Drawings	
B: Site Data – Text: Primary Drawings	
B: Site Data – Text: Synthesised Drawings	
C: Finds Data – Text: Primary Finds Data	
C: Finds Data – Text: Synthesised Finds Data	
C: Finds Data – Text: Specialist Reports	
C: Finds Data – Text: Box/Bag List	
D: Catalogue of Photos/Slides/Videos/X--rays	
E: Environmental/Ecofact Data: Primary Records	
E: Environmental/Ecofact Data: Synthesised Records	
E: Environmental/Ecofact Data: Specialist Reports	
F: Documentary	
F: Press and Publicity	
G: Correspondence	
H: Miscellaneous	

SITE: ST LUKES CHURCH, ISINGTON			SITE CODE: OLROO		SHEET NO: 1 (NORTH GOMEXU)	
TBM	Backsight	Instrument Height (IH) (TBM+ Backsight)	Level No	Foresight	Reduced Level (IH - Foresight)	Comments/Context No(s)/Small Find No(s)/Plan or Section No(s)
21.43	1.04	22.47		2.93	19.54	BURIAL. 119
	1.13	22.56		2.36	20.20	BURIAL. 120
	0.78	22.21		3.01	19.20	BURIAL 122
	0.78	22.21		2.30	19.91	BURIAL 159
	0.33	21.76		2.85	18.91	B. 160
	0.31	21.74		2.10	19.64	B. 163
	0.31	21.74		1.33	20.41	DATUM, SEC. 7
	0.27	21.70		2.53	19.17	B. 185 & 186
	0.30	21.73		1.18	20.56	DATUM, SEC. 8
	0.30	21.73		4.73	17.00	PLAN 3, A: BASE OF DOL
	0.70	22.13		3.00	19.13	B. 209
	0.26	21.69		2.76	18.93	B. 210
	0.26	21.69		2.80	18.89	B. 211 & 615
	0.24	21.67		3.92	17.75	V. 1208 - floor
	"	21.67		4.11	17.56	V. 1110 - floor
	"	21.67		3.91	17.76	V. 1109 - floor
	"	21.67		3.77	17.90	B. 214
	0.20	21.63		2.70	18.93	B. 215
	"	21.63		2.61	19.02	B. 217
	"	21.63		2.83	18.80	B. 216
	"	21.63		3.16	18.47	B. 218
	"	21.63		3.10	18.53	B. 219
21.43	0.20	21.63		2.02	19.61	B. 220
	"	21.63		2.37	19.26	B. 221
	"	21.63		3.30	18.33	B. 195
	"	21.63		3.63	18.00	B. 222, 223 & 224
	"	21.63		3.76	17.87	B. 196
	"	21.63		3.80	17.83	B. 225
	"	21.63		3.75	17.88	B. 226
	0.32	21.75		2.70	19.05	B. 228 & 346
	"	21.75		2.85	18.90	B. 229
	"	21.75		3.33	18.42	B. 230
	"	21.75		3.66	18.09	B. 231 & 232
	"	21.75		2.95	18.80	B. 233

SITE: ST LUKES CHURCH, ISLINGTON			SITE CODE: OLR 00		SHEET NO: 2 (North Cemetery)	
TBM	Backsight	Instrument Height (IH) (TBM+ Backsight)	Level No	Foresight	Reduced Level (IH - Foresight)	Comments/Context No(s)/Small Find No(s)/Plan or Section No(s)
21.43	0.32	21.75		3.09	18.66	B. 234
	"	21.75		3.05	18.70	B. 235
	"	21.75		3.55	18.20	B. 236
	"	21.75		4.20	17.55	B. 237
	"	21.75		4.70	17.05	Plan 3, 2, base of N.W. corner
	0.18	21.61		2.60	19.01	B. 244
	"	21.61		2.85	18.76	B. 245
	"	21.61		2.87	18.74	B. 246
	"	21.61		2.93	18.68	B. 241
	"	21.61		3.18	18.43	B. 242
	"	21.61		3.47	18.14	B. 243 & 345
	"	21.61		2.94	18.67	B. 247 & 248
	"	21.61		3.67	17.94	B. 249
	"	21.61		4.07	17.54	B. 250
	0.17	21.60		3.05	18.55	B. 252
	"	21.60		4.20	17.40	B. 260
	"	21.60		2.67	18.93	B. 261
	"	21.60		3.09	18.51	B. 265
	0.14	21.57		2.90	18.67	B. 266
	"	21.57		2.99	18.58	B. 267
	"	21.57		3.26	18.31	B. 268
	"	21.57		3.36	18.21	B. 269
	"	21.57		3.47	18.10	B. 272
	"	21.57		3.35	18.22	B. 271
	"	21.57		4.69	16.88	B. 273
	0.28	21.71		3.19	18.51	B. 274: Pb Coffin
	"	21.71		3.15	18.56	B. 275
	"	21.71		4.23	17.48	B. 276
	"	21.71		4.23	17.48	B. 277
	"	21.71		2.95	18.76	B. 278
	"	21.71		3.00	18.71	B. 279
	"	21.71		3.36	18.35	B. 280
	"	21.71		4.43	17.28	Plan 3, 3, base of Dig.
	"	21.71		2.93	18.78	B. 281: Pb Coffin

20/09/00

SITE: ST LUKES CHURCH, ISINGTON			SITE CODE: DL R00		SHEET NO: 3 (North Cemetery)	
TBM	Backsight	Instrument Height (IH) (TBM+ Backsight)	Level No	Foresight	Reduced Level (IH - Foresight)	Comments/Context No(s)/Small Find No(s)/Plan or Section No(s)
21.43	0.28	21.71		3.25	18.56	B.282
	"	21.71		3.65	18.06	B.283+4, 287+8
	"	21.71		2.42	18.29	B.286
	0.29	21.72		3.94	17.78	B.316
21.09.00	0.27	21.70		3.76	17.94	B.289
	"	21.70		3.97	17.73	B.290
	"	21.70		4.10	17.60	B.291
	"	21.70		4.18	17.52	B.292
	"	21.70		3.30	18.40	B.295
	"	21.70		3.30	18.40	B.296
	"	21.70		3.33	18.37	B.297
	"	21.70		3.35	18.35	B.298
	"	21.70		3.89	17.81	B.312
	"	21.70		3.29	18.41	B.313
	"	21.70		3.72	17.98	B.314
	"	21.70		2.89	18.81	B.315: Small Jar
	"	21.70		4.57	17.33	B.276 (Lance m.f.)
	"	21.70		4.50	17.20	B.277 (Lance m.f.)
22.09.00	0.29	21.72		2.96	18.76	B.317
	"	21.72		3.13	18.59	B.318
	"	21.72		3.19	18.53	B.322
	"	21.72		3.01	18.71	B.321
	"	21.72		2.93	18.79	B.320
	"	21.72		3.05	18.67	B.323
	"	21.72		3.01	18.71	B.324
	"	21.72		3.14	18.58	B.325
	"	21.72		3.25	18.47	B.326
	"	21.72		3.31	18.41	B.327
	"	21.72		3.33	18.39	B.328
25.09.00	0.16	21.59		3.40	18.19	B.329
	"	21.59		3.45	18.14	B.330 + 1107
	"	21.59		3.68	17.91	B.331
	"	21.59		3.65	17.94	B.365
	"	21.59		3.94	17.65	B.366

SITE: <u>St Luke's Church, Islingson</u>			SITE CODE: <u>OLR00</u>		SHEET NO: <u>4 (North Cemetery)</u>	
TBM	Backsight	Instrument Height (IH) (TBM+ Backsight)	Level No	Foresight	Reduced Level (IH - Foresight)	Comments/Context No(s)/Small Find No(s)/Plan or Section No(s)
21.43	0.16	21.59		3.97	17.62	B. 319
	"	21.59		4.05	17.54	B. 367
	"	21.59		2.99	18.60	B. 368
	0.18	21.61		3.10	18.51	B. 369
	"	21.61		3.16	18.45	B. 370
	"	21.61		3.32	18.29	B. 371
	"	21.61		3.67	17.94	B. 372
	"	21.61		2.66	18.95	B. 373
	"	21.61		2.66	18.95	B. 374
	"	21.61		3.01	18.60	B. 375
	"	21.61		3.12	18.49	B. 376
	"	21.61		3.26	18.35	B. 377
	"	21.61		3.37	18.24	B. 378
	"	21.61		3.24	18.37	B. 379
	"	21.61		3.36	18.25	B. 380
	"	21.61		3.68	17.93	B. 381
	"	21.61		3.24	18.37	B. 382
	0.31	21.74		3.89	17.85	B. 378
	"	21.74		4.24	17.40	B. 385
	"	21.74		3.72	18.01	B. 386
	"	21.74		3.95	17.79	B. 387
	"	21.74		4.25	17.49	B. 388
	"	21.74		0.75	20.99	Drum, Sect. 10
	"	21.74		3.70	18.04	B. 383
	"	21.74		4.29	17.45	B. 384
	"	21.74		4.05	17.69	B. 389
	"	21.74		3.75	17.99	B. 390
	"	21.74		3.24	18.50	B. 391
	"	21.74		3.36	18.38	B. 392
	"	21.74		3.60	18.14	B. 393
	"	21.74		3.48	18.26	B. 395
	"	21.74		3.72	18.02	B. 396
	"	21.74		3.31	18.43	B. 398
	"	21.74		3.49	18.25	B. 399

24/09/00

24/09/00

SITE: ST LUKES CHURCH, ISLINGTON			SITE CODE: ALR 00		SHEET NO: 5 (North Cemetery)	
TBM	Backsight	Instrument Height (IH) (TBM+ Backsight)	Level No	Foresight	Reduced Level (IH - Foresight)	Comments/Context No(s)/Small Find No(s)/Plan or Section No(s)
21.43	0.31	21.74		3.80	17.94	B. 397
		21.74		3.94	17.80	B. 394
		21.74		4.05	17.69	B. 400
		21.74		4.06	17.68	B. 401
		21.74		4.24	17.50	B. 402
		21.74		4.14	17.60	B. 403
		21.74		4.14	17.60	B. 404
		21.74		4.38	17.36	Plan 3, 4, on top of
		21.74		2.72	19.02	B. 405
		21.74		2.78	18.96	B. 406
		21.74		2.94	18.80	B. 407
		21.74		3.22	18.52	B. 408
		21.74		3.34	18.40	B. 409
		21.74		3.57	18.17	B. 411
		21.74		3.58	18.15	B. 410
		21.74		3.49	18.25	B. 412
		21.74		3.66	18.08	B. 413
		21.74		3.76	17.98	B. 414
		21.74		2.83	18.91	B. 416
		21.74		2.95	18.79	B. 415
	0.24	21.67		2.92	18.75	B. 417
		21.67		3.10	18.57	B. 418
		21.67		3.04	18.63	B. 419
		21.67		3.07	18.60	B. 420
		21.67		3.18	18.49	B. 421
		21.67		3.24	18.43	B. 422
		21.67		3.32	18.35	B. 423
	0.31	21.74		3.80	17.94	B. 424
		21.74		3.75	17.99	B. 425
		21.74		3.87	17.85	B. 426
		21.74		3.90	17.84	B. 427
		21.74		3.05	18.69	B. 428
		21.74		3.05	18.69	B. 430
		21.74		2.83	18.91	B. 431

21/09/00

21/09/00

X

SITE: <u>St Lucia Church, Slington</u>			SITE CODE: <u>OLR 00</u>		SHEET NO: <u>6 (North Concretary)</u>	
TBM	Backsight	Instrument Height (IH) (TBM+ Backsight)	Level No	Foresight	Reduced Level (IH - Foresight)	Comments/Context No(s)/Small Find No(s)/Plan or Section No(s)
21.43	0.31	21.74		2.60	19.08	B. 432
	0.29	21.72		3.21	18.51	B. 429
	"	21.72		3.34	18.38	B. 433
	"	21.72		3.21	18.51	B. 434
	"	21.72		3.10	18.62	B. 435
	"	21.72		3.26	18.46	B. 436
	"	21.72		2.60	19.12	B. 439
	"	21.72		2.80	18.92	B. 440
	"	21.72		3.03	18.69	B. 441
	"	21.72		3.25	18.47	B. 442
	"	21.72		3.35	18.37	B. 437
	"	21.72		3.55	18.17	B. 438
	"	21.72		3.60	18.12	B. 443
	"	21.72		4.13	17.59	B. 444
	0.17	21.26		4.84	16.42	B. 445
	"	21.26		5.00	16.26	B. 446 & 447
	0.71	21.87		6. 3.71 19	15.95	B. 448
	0.56	21.99		3.76	18.23	B. 449
	"	21.99		4.22	17.77	B. 450
	"	21.99		3.87	18.12	B. 451
	"	21.99		5.05	16.94	Plan 3, 5
	"	21.99		4.26	17.73	B. 452 + B1059.
	0.35	21.78		1.33	20.45	Drum, Sect. 11
	"	21.78		3.36	18.47	B. 453
	"	21.78		3.55	18.23	B. 454
	"	21.78		2.82	18.96	B. 455
	"	21.78		3.58	18.20	B. 458
	"	21.78		3.43	18.35	B. 459
	"	21.78		3.31	18.47	B. 457
	"	21.78		4.51	17.27	B. 460
	"	21.78		3.22	18.56	B. 461
	"	21.78		3.21	18.57	B. 462
	0.16	21.59		3.26	18.33	B. 463
	"	21.59		3.37	18.22	B. 498

02/10/00

03/10/00

04/10/00

05/10/00

SITE: ST LUKE'S CHURCH, ISLINGTON			SITE CODE: OLK 00		SHEET NO: 7 (North Cemetery)	
TBM	Backsight	Instrument Height (IH) (TBM+ Backsight)	Level No	Foresight	Reduced Level (IH - Foresight)	Comments/Context No(s)/Small Find No(s)/Plan or Section No(s)
21.43	0.16	21.59		3.07	18.52	B. 499
	"	21.59		3.22	18.37	B. 500
	"	21.59		3.66	17.93	B. 501
	"	21.59		3.65	17.94	B. 502
	"	21.59		3.60	17.99	B. 503
	"	21.59		3.76	17.83	B. 504
	"	21.59		4.20	17.39	B. 505
	"	21.59		4.23	17.36	B. 506
	"	21.59		3.33	18.26	B. 507
	"	21.59		3.45	18.14	B. 509
	"	21.59		3.56	18.03	B. 508
	"	21.59		2.89	18.70	B. 510
	"	21.59		2.96	18.63	B. 511
	"	21.59		3.06	18.53	B. 512
	0.24	21.67		3.21	18.46	B. 513: Pb Coffin
	"	21.67		3.06	18.61	B. 514
	"	21.67		3.22	18.45	B. 516
	"	21.67		3.34	18.33	B. 518
	"	21.67		3.43	18.24	B. 515
	"	21.67		3.46	18.21	B. 517
	"	21.67		3.65	18.02	B. 519
	"	21.67		3.89	17.78	B. 520
	"	21.67		3.96	17.71	B. 522
	"	21.67		3.89	17.78	B. 521
	"	21.67		2.61	19.06	B. 523
	"	21.67		2.76	18.91	B. 524
	"	21.67		2.90	18.77	B. 525
	0.18	21.61		3.21	18.40	B. 528
	"	21.61		3.29	18.32	B. 529
	"	21.61		3.36	18.25	B. 530
	"	21.61		3.02	18.59	B. 526
	"	21.61		3.16	18.45	B. 527
	"	21.61		3.54	18.07	B. 565
	"	21.61		3.27	18.34	B. 564

0x110/00

1x110/00

SITE: <u>St Lukes Church, Islington</u>			SITE CODE: <u>OLR00</u>		SHEET NO: <u>8 (North Cemetery)</u>	
TBM	Backsight	Instrument Height (IH) (TBM+ Backsight)	Level No	Foresight	Reduced Level (IH - Foresight)	Comments/Context No(s)/Small Find No(s)/Plan or Section No(s)
21.43	0.18	21.61		3.48	18.13	B. 566
	"	21.61		3.65	17.96	B. 567
	"	21.61		3.65	17.96	B. 568
				3.97	17.64	B. 569
				3.95	17.66	B. 570
				4.34	17.27	B. 571
				4.55	17.06	Plan 3, Base of dig.
				2.53	19.08	B. 572
				2.83	18.78	B. 573
				2.87	18.74	B. 574
				3.02	18.59	B. 575
	↓	↓		3.09	18.52	B. 576
	0.15	21.58		2.95	18.63	B. 577
				3.12	18.46	B. 578
				3.31	18.27	B. 579
				3.42	18.16	B. 580
	↓	↓		3.59	17.99	B. 581
	0.19	21.62		3.05	18.57	B. 584
				3.21	18.41	B. 585
				3.49	18.13	B. 586
				3.08	18.54	B. 590
				3.35	18.27	B. 591
				3.23	18.39	B. 592
				3.51	18.11	B. 593
	↓	↓		3.66	17.96	B. 594
	0.19	21.62		3.77	17.85	B. 587
				3.95	17.67	B. 588
	↓	↓		4.10	17.52	B. 595
	0.21	21.64		2.94	18.70	B. 596
				3.15	18.49	B. 630
				3.28	18.36	B. 631
				3.20	18.44	B. 632
				3.29	18.35	B. 633
↓	↓	↓		3.20	18.44	B. 634

10/10

11/10

SITE: St Lukes church, Islington

SITE CODE: OL200

SHEET NO: 9 (North churchyard)

TBM	Backsight	Instrument Height (IH) (TBM+ Backsight)	Level No	Foresight	Reduced Level (IH - Foresight)	Comments/Context No(s)/Small Find No(s)/Plan or Section No(s)
21.43	0.21	21.64		3.42	18.22	B. 635
	↓	↓		3.30	18.34	B. 636
	↓	↓		3.74	17.90	B. 637
	0.50	21.93		3.94	17.99	B. 638
	↓	↓		2.37	19.56	B. 639
	↓	↓		2.52	19.41	B. 640
	↓	↓		2.75	19.18	B. 641
	↓	↓		2.94	18.99	B. 642
	↓	↓		3.01	18.92	B. 643
	↓	↓		2.91	19.02	B. 644
	0.07	21.50		3.91	17.59	B. 645
	↓	↓		3.91	17.59	B. 646
	↓	↓		3.87	17.63	B. 647
	↓	↓		2.59	18.91	B. 648
	↓	↓		2.68	18.82	B. 649
	↓	↓		2.90	18.60	B. 650
	↓	↓		2.90	18.60	B. 651
	↓	↓		2.94	18.56	B. 652
	↓	↓		3.50	18.00	B. 653
	↓	↓		3.61	17.89	B. 654
	↓	↓		2.36	19.14	B. 655
	0.22	21.65		2.89	18.76	B. 656
	↓	↓		3.43	18.22	B. 657
	↓	↓		3.75	17.90	B. 658
	↓	↓		3.86	17.79	B. 659
	↓	↓		4.22	17.43	B. 660
	↓	↓		4.22	17.43	B. 661
	↓	↓		2.93	18.72	B. 662
	↓	↓		3.39	18.26	B. 663
	↓	↓		3.28	18.37	B. 668
	↓	↓		3.09	18.56	B. 665
	↓	↓		3.23	18.42	B. 666
	↓	↓		3.41	18.24	B. 667
	↓	↓		3.50	18.15	B. 669

12/10

13/10

16/10

SITE: <i>St Lukes church, Islington</i>			SITE CODE: <i>OLR00</i>		SHEET NO: <i>10 (North churchyard)</i>		
TBM	Backsight	Instrument Height (IH) (TBM+ Backsight)	Level No	Foresight	Reduced Level (IH - Foresight)	Comments/Context No(s)/Small Find No(s)/Plan or Section No(s)	
	<i>21.43</i>	<i>0.22</i>	<i>21.65</i>		<i>3.75</i>	<i>17.90</i>	<i>B. 664</i>
<i>17/10</i>		<i>0.18</i>	<i>21.61</i>		<i>3.74</i>	<i>17.87</i>	<i>670 top of well.</i>
					<i>4.36</i>	<i>17.25</i>	<i>670 base of dig.</i>
					<i>4.32</i>	<i>17.29</i>	<i>B. 671</i>
					<i>4.32</i>	<i>17.29</i>	<i>B. 672</i>
					<i>2.80</i>	<i>18.81</i>	<i>B. 673</i>
					<i>2.91</i>	<i>18.70</i>	<i>B. 674</i>
					<i>2.99</i>	<i>18.62</i>	<i>B. 675</i>
					<i>3.04</i>	<i>18.57</i>	<i>B. 676</i>
					<i>3.29</i>	<i>18.32</i>	<i>B. 678</i>
					<i>3.46</i>	<i>18.15</i>	<i>B. 677</i>
					<i>3.63</i>	<i>17.98</i>	<i>B. 679</i>
					<i>3.82</i>	<i>17.79</i>	<i>B. 680</i>
					<i>3.93</i>	<i>17.68</i>	<i>B. 681</i>
<i>18/10</i>		<i>0.22</i>	<i>21.65</i>		<i>4.29</i>	<i>17.36</i>	<i>B. 682</i>
					<i>4.33</i>	<i>17.32</i>	<i>B. 683</i>
					<i>2.52</i>	<i>19.13</i>	<i>B. 684</i>
					<i>2.66</i>	<i>18.99</i>	<i>B. 685</i>
					<i>2.87</i>	<i>18.78</i>	<i>B. 686</i>
					<i>2.80</i>	<i>18.85</i>	<i>B. 687</i>
					<i>2.99</i>	<i>18.66</i>	<i>B. 689</i>
					<i>3.14</i>	<i>18.51</i>	<i>B. 690</i>
					<i>3.15</i>	<i>18.50</i>	<i>B. 691</i>
					<i>3.17</i>	<i>18.48</i>	<i>B. 692</i>
					<i>3.33</i>	<i>18.32</i>	<i>B. 693</i>
					<i>3.53</i>	<i>18.12</i>	<i>B. 694</i>
<i>19/10</i>		<i>0.24</i>	<i>21.67</i>		<i>3.79</i>	<i>17.88</i>	<i>B. 695</i>
					<i>3.79</i>	<i>17.88</i>	<i>B. 729</i>
					<i>3.78</i>	<i>17.89</i>	<i>B. 730</i>
					<i>4.37</i>	<i>17.30</i>	<i>B. 731</i>
					<i>2.61</i>	<i>19.06</i>	<i>B. 732</i>
					<i>2.68</i>	<i>18.99</i>	<i>B. 733</i>
					<i>2.81</i>	<i>18.86</i>	<i>B. 734</i>
					<i>2.89</i>	<i>18.78</i>	<i>B. 735</i>

SITE: <i>St Lukes church, Islington</i>			SITE CODE: <i>OLROD</i>		SHEET NO: <i>11 (north churchyard)</i>	
TBM	Backsight	Instrument Height (IH) (TBM+ Backsight)	Level No	Foresight	Reduced Level (IH - Foresight)	Comments/Context No(s)/Small Find No(s)/Plan or Section No(s)
<i>21.43</i>	<i>0.24</i>	<i>21.67</i>		<i>3.00</i>	<i>18.67</i>	<i>B.736</i>
				<i>3.46</i>	<i>18.21</i>	<i>B.739</i>
				<i>2.75</i>	<i>18.92</i>	<i>B.737</i>
				<i>2.83</i>	<i>18.84</i>	<i>B.738</i>
				<i>2.95</i>	<i>18.72</i>	<i>B.740</i>
	↓	↓		<i>3.24</i>	<i>18.43</i>	<i>B.741</i>
	<i>0.21</i>	<i>21.64</i>		<i>3.93</i>	<i>17.71</i>	<i>Plan 3 7 bench d.g.</i>
				<i>2.90</i>	<i>18.74</i>	<i>B.742</i>
				<i>3.03</i>	<i>18.61</i>	<i>B.743</i>
				<i>3.23</i>	<i>18.41</i>	<i>B.744</i>
				<i>3.13</i>	<i>18.51</i>	<i>B.745</i>
				<i>3.20</i>	<i>18.44</i>	<i>B.746</i>
				<i>2.69</i>	<i>18.95</i>	<i>B.747</i>
				<i>3.10</i>	<i>18.54</i>	<i>B.748</i>
				<i>3.15</i>	<i>18.49</i>	<i>B.749</i>
				<i>3.73</i>	<i>17.91</i>	<i>B.750</i>
				<i>2.45</i>	<i>19.19</i>	<i>B.751</i>
				<i>2.47</i>	<i>19.17</i>	<i>B.752</i>
				<i>2.86</i>	<i>18.78</i>	<i>B.754</i>
				<i>3.15</i>	<i>18.49</i>	<i>B.755</i>
				<i>3.29</i>	<i>18.35</i>	<i>B.756</i>
				<i>3.53</i>	<i>18.11</i>	<i>B.757</i>
				<i>3.27</i>	<i>18.37</i>	<i>B.758</i>
				<i>3.49</i>	<i>18.15</i>	<i>B.759</i>
				<i>3.83</i>	<i>17.81</i>	<i>B.796</i>
				<i>3.75</i>	<i>17.89</i>	<i>B.795</i>
				<i>3.62</i>	<i>18.02</i>	<i>B.761</i>
	↓	↓		<i>3.50</i>	<i>18.14</i>	<i>B.760</i>
<i>21.43</i>	<i>0.61</i>	<i>22.04</i>		<i>4.11</i>	<i>17.93</i>	<i>Base of wall for V. 104 - Datum Sect 1.</i>
↓	<i>0.35</i>	<i>21.78</i>		<i>1.33</i>	<i>20.45</i>	<i>DATUM SECT 16</i>

20/10

31/10
6/12

SITE: <u>St. Wess Church</u> <u>15 Linneton</u>			SITE CODE: <u>OLR 00</u>		SHEET NO: <u>12</u> (SOUTH CHURCHYARD)	
TBM	Backsight	Instrument Height (IH) (TBM+ Backsight)	Level No	Foresight	Reduced Level (IH - Foresight)	Comments/Context No(s)/Small Find No(s)/Plan or Section No(s)
21-13	1-16	22.29	1	2-12	20.17	PLAN 4
			2	1-84	20.45	(LEDBER STONES
			3	1-83	20.46	AND SCARS
			4	1-90	20.39	INDICATIVE OF OLD GRANITIZED SURFACE
			5	1-89	20.40	(INCLUDES REMAINS OF HEADSTONES - PRESUMABLY LAID DOWN PRIOR TO LANDSCAPING)
			6	2-03	20.26	
			7	2-07	20.22	
			8	2-15	20.14	
			9	1-99	20.30	
			10	2-02	20.27	
			11	1-99	20.30	
			12	2-07	20.22	
			13	2-15	20.14	
			14	2-17	20.12	
			15	2-28	20.01	
	1-20	22.33	16	1-89	20.44	(OLD PAVED P TH ADJACENT TO CHURCH)
			17	1-88	20.45	
			18	2-01	20.32	
			19	1-82	20.51	(TOP OF MONUMENT ON W TOP V OF VAULT 111)
	0-75	21.88		4-28	17.60	B. 191
				4-07	17.81	BASE OF WALLS FOR VAULT (493)
	0-94	22.07	20	1-81	20.26	PLAN 4 (238)
			21	1-67	20.40	(239)
			22	1-78	20.29	(126) SLAB
	1-16	22.29	23	2-00	20.29	(332)
			24	1-91	20.38	(332)
	1-23	22.36		4-57	17.79	VAULT (483) (Floor)
	1-23		DATUM	4-57	17.79	SECTION 12
	0-27	21.40		4-24	17.16	V. (111) - Floor
				2-45	18.95	V. (496) - Floor
			DATUM	2-68	18.72	SECTION 13
V	0-18	21.31		3-80	17.51	V. (126)
21-13	0-59	21.72		4-10	17.62	B. 798
				4-58	17.14	B. 800

24/10

OXFORD ARCHAEOLOGICAL UNIT

LEVELS REGISTER

SITE: ST. WYCES CHURCH LUNNETHTON			SITE CODE: OLR 00		SHEET NO: 13 (SOUTH CHURCHYARD)		
TBM	Backsight	Instrument Height (IH) (TBM+ Backsight)	Level No	Foresight	Reduced Level (IH - Foresight)	Comments/Context No(s)/Small Find No(s)/Plan or Section No(s)	
24/10	21.13	0.59	21.72		2.83	18.89	B. 801
	↓	↓			3.25	18.47	B. 802
	↓	↓			4.56	17.16	PLAN 6 TA (BASE OF DIG)
25/10		0.33	21.46		3.30	18.16	B. 803
	↓	↓			3.37	18.089	B. 804
	↓	↓			3.54	17.92	B. 805
	↓	↓	DATUM		0.96	20.50	SECTION 14
26/10		0.35	21.48		4.01	17.47	B. 806
	↓	↓			3.23	18.25	B. 807
	↓	↓			3.30	18.18	B. 808
	↓	↓			3.67	17.81	B. 809
	↓	↓			2.80	18.68	B. 810
	↓	↓			2.98	18.50	B. 811
	↓	↓			3.22	18.26	B. 812
	↓	↓			3.24	18.24	B. 813
	↓	↓			3.26	18.22	B. 814
	↓	↓			3.48	18.00	B. 815
	↓	↓			3.60	17.88	B. 816
	↓	↓			3.60	17.88	B. 817
27/10		0.35	21.48		3.24	18.24	B. 818
	↓	↓			3.57	17.91	B. 819
	↓	↓			3.84	17.64	B. 820
	↓	↓			4.10	17.38	B. 821
	↓	↓			4.24	17.24	B. 822
	↓	↓			4.53	16.95	B. 823
	↓	↓			4.65	16.83	B. 824
	↓	↓			3.14	18.34	B. 825
	↓	↓			3.40	18.08	B. 826
01/11	21.13	0.59	21.72		3.78	17.94	B. 827
	↓	↓			3.80	17.92	B. 861
	↓	↓			4.00	17.72	B. 862
	↓	↓			2.93	18.79	B. 863
	↓	↓			3.35	18.37	B. 864
	↓	↓			3.46	18.26	B. 865

SITE: ST. WEEPS CHURCH SUNNINGTON			SITE CODE: OLR 00	SHEET NO: 14 (SOUTH CHURCHYARD)		
TBM	Backsight	Instrument Height (IH) (TBM+ Backsight)	Level No	Foresight	Reduced Level (IH - Foresight)	Comments/Context No(s)/Small Find No(s)/Plan or Section No(s)
	0.59	21.72		3.84	17.88	B. 866
↓	↓	↓		4.39	17.33	B. 867
21-13	0.53	21.66		3.93	17.73	A24 - BASE
↓	↓	↓		4.40	17.26	PLAN B #2 - DEPTH OF DIG
				3.27	18.39	B. 871
				3.49	18.17	B. 872
↓	↓	↓		4.50	17.16	B. 873
21-13	0.55	21.68		3.37	18.31	B. 874
↓	↓	↓		3.45	18.23	B. 875
				3.97	17.71	B. 876
				4.30	17.38	B. 877
				3.54	18.14	B. 878
				3.76	17.92	B. 879
				3.21	18.47	B. 880
				3.50	18.18	B. 881
				3.73	17.95	B. 882
↓	↓	↓		4.00	17.68	B. 883
21-13	0.57	21.70		4.03	17.67	B. 884
↓	↓	↓		4.19	17.51	B. 885
	↓	↓		4.36	17.34	B. 886
	0.58	21.71		4.36	17.35	B. 887
	↓	↓		4.51	17.20	B. 888
	↓	↓		4.59	17.12	B. 889
	↓	↓		3.00	18.71	B. 890
↓	↓	↓		3.14	18.57	B. 891
21-13	0.50	21.63		3.22	18.41	B. 892
↓	↓	↓		3.49	18.14	B. 893
				3.78	17.85	B. 927
				3.79	17.84	B. 928
				3.80	17.83	B. 929
				3.82	17.81	B. 930
↓	↓	↓		3.86	17.77	B. 931
21-13	0.61	21.74		4.30	17.44	B. 932
	↓	↓		3.71	18.03	B. 933

07/11

08/11

09/11

10/11

13/11

SITE: ST. WIVES CHURCH SLINGFORD			SITE CODE: OLR 00		SHEET NO: 15 (South Churchyard)		
TBM	Backsight	Instrument Height (IH) (TBM+ Backsight)	Level No	Foresight	Reduced Level (IH - Foresight)	Comments/Context No(s)/Small Find No(s)/Plan or Section No(s)	
13/11	0.64	21.74		3-23	18.51	B. 934	
				3-67	18.07	B. 935	
				3-77	17.97	B. 936	
				4-02	17.72	B. 937	
14/11	0.64	21.77		3-11	18.63	B. 938	
				2-96	18.81	B. 940	
				3-14	18.63	B. 939	
				3-55	18.22	B. 941	
				3-58	18.19	B. 942	
				3-58	18.19	B. 943	
				4-01	17.76	B. 944	
				4-21	17.56	B. 945	
				4-79	16.98	B. 946	
				3-38	18.39	B. 947	
				3-50	18.27	B. 948	
				3-57	18.20	B. 949	
			15/11	0.59	21.72		4-08
	3-97	17.75				B. 952	
	4-03	17.69				B. 951	
	4-34	18.38				B. 953	
	4-42	17.30				B. 954	
	4-59	17.13				PLAN 6 π3 (DEPTH OF DIG)	
	DATUM	4-59				17.13	SECTION 19
		3-04				18.68	B. 955
		3-57				18.21	B. 956
		3-71				18.01	B. 957
		3-81				17.91	B. 958
		4-69				17.03	B. 959
		4-87				16.85	B. 993
16/11	0.64	21.77		4-94	16.78	PLAN 6 π4 (LEVEL AT THE BASE OF CUT FOR B. 993, DEEPER DUE TO COLLAPSE)	
				3-32	18.40	B. 994	
				3-88	17.89	B. 995	

SITE: ST. LUKES CHURCH BUNNETON			SITE CODE: OUR 00		SHEET NO: 16 (SOUTH CHURCHYARD)				
TBM	Backsight	Instrument Height (IH) (TBM+ Backsight)	Level No	Foresight	Reduced Level (IH - Foresight)	Comments/Context No(s)/Small Find No(s)/Plan or Section No(s)			
16/11 ↓	0.64 ↓	21.77 ↓		3.65	18.12	B. 996			
				4.35	17.42	B. 997			
				4.60	17.17	B. 998			
				3.31	18.46	B. 999			
				3.36	18.41	B. 1000			
				3.44	18.33	B. 1001			
				3.64	18.13	B. 1002			
				3.85	17.92	B. 1003			
				3.88	17.89	B. 1004			
			17/11 ↓	0.62 ↓	21.75 ↓		3.18	18.57	B. 1007
	3.46	18.29				B. 1008			
	3.63	18.12				B. 1009			
20/11 ↓	0.64 ↓	21.77 ↓		3.82	17.95	B. 1010			
				3.74	18.03	B. 1011			
				* 4.95	16.82	PLAN 675 (DEPTH OF DIG)			
				4.03	17.74	B. 1012			
				4.24	17.53	B. 1013			
				4.51	17.26	B. 1014			
				4.61	17.16	B. 1015			
			21/11 ↓	0.63 ↓	21.76 ↓		4.04	17.72	B. 1016
							4.15	17.61	B. 1017
							4.32	17.44	B. 1018
	4.72	17.04				B. 1019			
	4.79	16.97				B. 1020			
	5.20	16.56				B. 1021			
	5.27	16.49				B. 1022			
22/11 ↓	0.64 ↓	21.77 ↓					3.46	18.31	B. 1023
							3.40	18.37	B. 1024
							3.57	18.20	B. 1025
				3.88	17.89	B. 1026			
				4.05	17.72	B. 1027			
				4.29	17.48	B. 1028			
				4.33	17.44	BRICK PLATFORM			
				3.33	18.44	B. 1029			

SITE: ST. WEEPS CHURCH LESLINGTON			SITE CODE: OLR 00	SHEET NO: 17 (SOUTH CHURCHYARD)		
TBM	Backsight	Instrument Height (IH) (TBM+ Backsight)	Level No	Foresight	Reduced Level (IH - Foresight)	Comments/Context No(s)/Small Find No(s)/Plan or Section No(s)
22/11	21-13	0.64	21.77	3.44	18.33	B. 1030
	↓	↓		3.57	18.20	B. 1031
	↓	↓		3.86	17.91	B. 1032
	↓	↓		3.93	17.84	B. 1033
23/11	21-13	0.61	21.74	4.16	17.58	B. 1034
	↓	↓		3.36	18.38	B. 1035
	↓	↓		3.43	18.31	B. 1036
	↓	↓		3.48	18.26	B. 1037
27/11	21-13	0.66	21.79	3.32	18.47	B. 1038
	↓	↓		3.66	18.13	B. 1039
	↓	↓		4.03	17.76	B. 1040
	↓	↓		4.00	17.79	B. 1041
	↓	↓		4.27	17.52	B. 1042
	↓	↓		5.10	16.69	B. 1043
	↓	↓		5.10	16.69	B. 1044
	↓	↓		5.20	16.59	B. 1045
	↓	↓		5.30	16.49	B. 1046
28/11	21-13	0.61	21.74	3.10	18.64	B. 1047
	↓	↓		3.18	18.56	B. 1048
	↓	↓		3.28	18.46	B. 1049
	↓	↓		3.38	18.36	B. 1050
	↓	↓		3.46	18.28	B. 1051
	↓	↓		3.63	18.11	B. 1052
	↓	↓		3.63	18.11	B. 1053
	↓	↓		4.20	17.54	B. 1054
	↓	↓		3.53	18.21	B. 1055
	↓	↓		4.08	17.66	B. 1056
29/11	21-13	0.64	21.77	4.32	17.45	B. 1058
		↓	↓	4.42	17.35	B. 1057
30/11	21-13	0.62	21.75	3.61	18.14	B. 1108
	↓	↓		3.47	18.28	B. 1109
	↓	↓		3.60	18.15	B. 1110
	↓	↓		4.39	17.36	B. 1111
	↓	↓		4.49	17.26	B. 1112

SITE: ST. WIVES CHURCH SLINGFORD			SITE CODE: OLR 00		SHEET NO: 18 (SOUTH CHURCHYARD)	
TBM	Backsight	Instrument Height (IH) (TBM+ Backsight)	Level No	Foresight	Reduced Level (IH - Foresight)	Comments/Context No(s)/Small Find No(s)/Plan or Section No(s)
30/11	21-13	0-62	21.75	4.59	17.16	B. 1113
	↓	↓		4.16	17.59	B. 1114
01/12	21-13	0-64	21.77	3.87	17.90	B. 1115
	↓	↓		3.93	17.84	1161 COBBLED SURFACE
04/12	21-13	0-62	21.75	3.07	18.68	B. 1117
	↓	↓		3.58	18.17	B. 1118
	↓	↓		4.30	17.45	B. 1119
	↓	↓		4.39	17.36	B. 1120
	↓	↓		3.46	18.29	B. 1121
	↓	↓		3.68	18.07	B. 1122
	↓	↓		3.97	17.78	B. 1123
05/12	21-13	0-63	21.76	3.96	17.80	B. 1124
	↓	↓		4.06	17.70	B. 1158
	↓	↓		3.91	17.85	B. 1159
	↓	↓		3.61	18.15	B. 1161
	↓	↓		4.39	17.367	B. 1162
	↓	↓		3.54	18.22	B. 1163
	↓	↓		3.77	17.99	B. 1164
	↓	↓		4.49	17.27	B. 1165
06/12	21-13	0-64	21.77	4.29	17.48	B. 1166 B. 1167 B. 1168 (3 IN W/ OFFSH)
	↓	↓		4.19	17.58	B. 1169
	↓	↓		4.31	17.46	B. 1170
	↓	↓		4.18	17.59	B. 1171
	↓	↓		4.28	17.49	B. 1172
	↓	↓		4.63	17.14	PLAN 6 TO (DEPTH OF DIG)
	↓	↓		3.26	18.51	B. 1173
	↓	↓		3.99	17.78	B. 1174
	↓	↓		4.09	17.68	B. 1175
	↓	↓		4.33	17.44	B. 1176
	↓	↓		4.33	17.44	B. 1177
	↓	↓		4.43	17.34	1178 BASE OF BRICK GRAVE
07/12	21-13	0-64	21.77	4.42	17.35	B. 1180
	↓	↓		4.42	17.35	B. 1181
	↓	↓		4.42	17.35	1179 BASE OF BRICK GRAVE

SITE: ST. LUKES CHURCH 15 LINDEN			SITE CODE: OUR 00		SHEET NO: 19 (SOUTH CHURCH YARD)	
TBM	Backsight	Instrument Height (IH) (TBM+ Backsight)	Level No	Foresight	Reduced Level (IH - Foresight)	Comments/Context No(s)/Small Find No(s)/Plan or Section No(s)
	NEW	BENCHMARK FROM HERE (WAS 21-13)				
	NEW	TBM LOCATED ON FOOTING OF SOUTHERN CHURCH WALL				
21-13	0-64	21-77		1-94	19.83	NEW TBM
19-83	1-94	21-77		2-97	18.80	B. 1182
	↓	↓		4-02	17.75	1160 ↑ AT BASE OF VAULT
	↓	↓	*	4-40	17-37	PLAN 6 ↑ ↑ (DEPTH OF DIG)
08/12	19-83	0-23		3-96	16-10	B. 1184
19-83	↓	↓		3-86	16-20	B. 1185
	↓	↓		1-78	18-28	B. 1183
	↓	↓		1-88	18-18	B. 1186
11/12	19-83	1-49		3-24	18-08	B. 1187
	↓	↓		3-26	18-06	B. 1188
	↓	↓		3-03	18-29	B. 1189
	↓	↓		3-55	17-77	B. 1190
	↓	↓		3-64	17-71	B. 1224
	↓	↓		3-76	17-56	B. 1225
	↓	↓		3-76	17-56	B. 1226
	↓	↓		4-14	17-18	B. 1227
	↓	↓		4-24	17-08	B. 1228
	↓	↓		4-34	16-98	B. 1229
12/12	19-83	1-48		3-00	18-31	B. 1230
	↓	↓		3-11	18-20	B. 1231
	↓	↓		3-30	18-01	B. 1232
	↓	↓		3-40	17-91	B. 1233
	↓	↓		3-28	18-03	B. 1234
	↓	↓		3-32	17-99	B. 1235
	↓	↓		3-82	17-49	B. 1236
	↓	↓		3-80	17-51	B. 1237
	↓	↓		4-05	17-26	B. 1238
	↓	↓		4-25	17-06	B. 1239
13/12	19-83	1-47		3-28	18-02	B. 1242
	↓	↓		3-15	18-15	B. 1241
	↓	↓		3-15	18-15	B. 1240
	↓	↓		3-63	17-67	B. 1243

SITE: ST. WIVES CHURCH LUMPTON			SITE CODE: OLR 00		SHEET NO: 20 (SOUTH CHURCHYARD)	
TBM	Backsight	Instrument Height (IH) (TBM+ Backsight)	Level No	Foresight	Reduced Level (IH - Foresight)	Comments/Context No(s)/Small Find No(s)/Plan or Section No(s)
13/12	1-47	21.30		3-20	18.10	B. 1244
				3-30	18.00	B. 1245
				3-52	17.78	B. 1246
				3-95	17.35	B. 1247
				4-10	17.20	B. 1248
				3-26	18.04	B. 1249
14/12	1-46	21.29		3-45	17.84	B. 1250
				3-55	17.74	B. 1251
				3-63	17.66	B. 1252
				4-05	17.24	B. 1253
				4-30	16.99	B. 1254
				4-30	16.99	B. 1255
				3-72	17.57	B. 1256
				3-85	17.44	B. 1263
				3-95	17.34	B. 1264
				3-30	17.99	B. 1266
				3-48	17.81	B. 1267
				4-18	17.11	B. 1268
				4-28	17.01	B. 1269
				* 4-40	16.89	B. 1270
			15/12	1-48	21.31	
	2-95	18.36				B. 1272
	3-00	18.31				B. 1273
	3-18	18.13				B. 1274
	3-14	18.17				B. 1275
	3-39	17.92				B. 1276
	3-56	17.75				B. 1277
	4-00	17.31				PLAN 6 & P (DEPTH OF DIG)
	4-00	17.31				
18/12	1-04	20.87		2-81	18.06	B. 1278
				2-34	18.53	B. 1279
				2-42	18.45	B. 1280
				2-50	18.37	B. 1281
				3-05	17.82	B. 1282
				3-46	17.71	B. 1283

Islington, Old Street, St Lukes
OLR00

Box 2 file 2

B. PRIMARY CONTEXT RECORDS - N° 1 - 27

SCAN PDF

FILMING INSTRUCTIONS

Submitter OASouth

No. of CD copies: 2

Headings

Site information

Line 1: [OASouth] County:[Greater London] Parish:[Islington] Site:[Old Street, St Lukes]

Site code[OLR00]

Line 2: Excavators name[A. Boyle]

Line 3:

Classification of material

Tick if present

Classification of material	Tick if present
Index to archive	
Introduction	
A:Final Report	
A:Publication Report	
B:Site Data – Text: Diary/Daybook/Fieldnotes	
B: Site Data – Text: General Summaries	
B: Site Data – Text: Primary Context Records - N° 1-27	✓
B: Site Data – Text: Synthesised Context Records	
B: Site Data – Text: Survey Reports	
B: Site Data – Text: Catalogue of Drawings	
B: Site Data – Text: Primary Drawings	
B: Site Data – Text: Synthesised Drawings	
C: Finds Data – Text: Primary Finds Data	
C: Finds Data – Text: Synthesised Finds Data	
C: Finds Data – Text: Specialist Reports	
C: Finds Data – Text: Box/Bag List	
D: Catalogue of Photos/Slides/Videos/X--rays	
E: Environmental/Ecofact Data: Primary Records	
E: Environmental/Ecofact Data: Synthesised Records	
E: Environmental/Ecofact Data: Specialist Reports	
F: Documentary	
F: Press and Publicity	
G: Correspondence	
H: Miscellaneous	

SITE ^{ST LUKES} ISLINGTON OLROO	CONTEXT RECORD ADDITIONAL SHEET	Context No. 
---	--	---

CHEST TOMB to north-west of church yard. No trace of inscription surviving. 4 sided with overhanging stone coping. South side brick - mainly yellow, some red. Average size 22cm x 7cm, Machine-made (19th) Stretcher bond. Hard cement-based grainy mortar.

Other 3 sides stone. Fairly plain, partly due to corrosion. All very worn. East side has simple vertical roll moulding 7.5-9.5cm in from N+S edges. W. side has faint trace of similar. Tomb surrounded by gravel/shingle. Coping limestone slab. Plinth surrounding tomb apparently formed of 3 pieces limestone, ie sides form single sections (see sketch below).

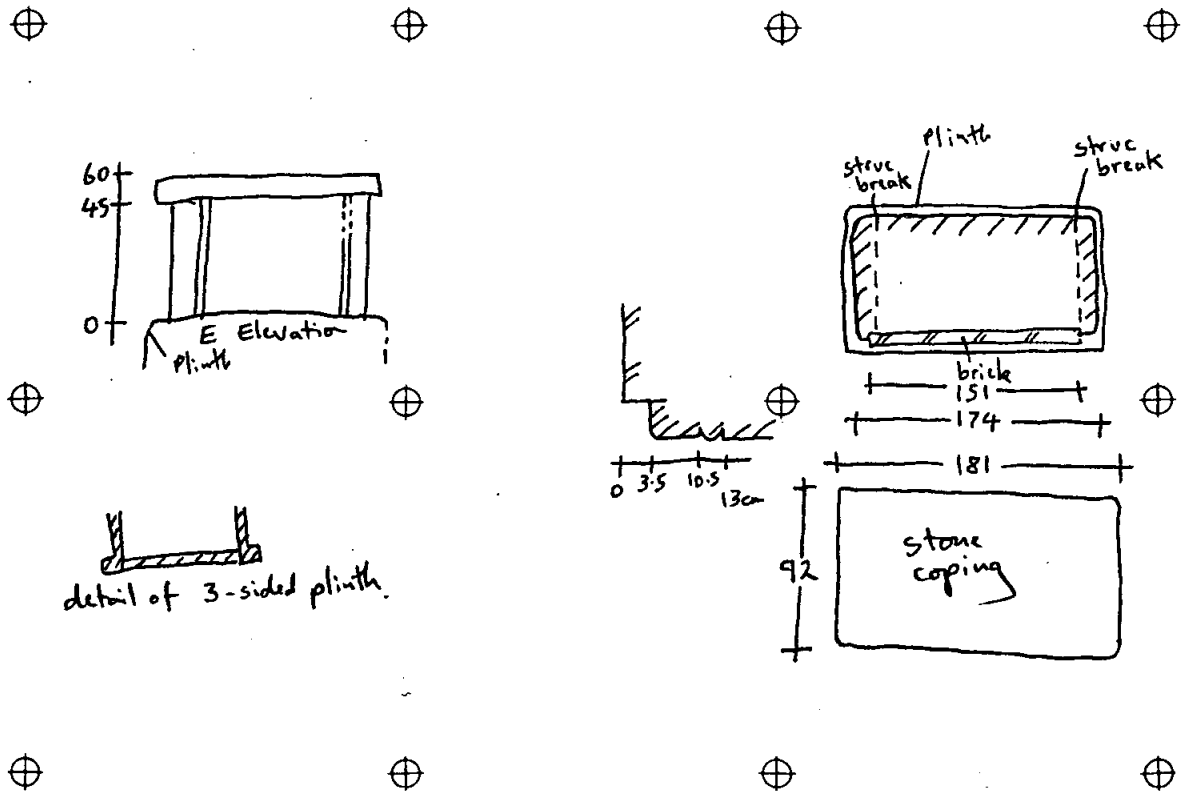

SITE ST LUKES
SLINGTON
OLROO

CONTEXT RECORD ~~ADDITIONAL~~ SHEET

Context No.

2

Chest tomb to N of church. Coping - 95cm x 195cm x 8.5cm.
Relatively non-corroded stone. Still smooth, limestone (?)
Chalky, soft stone base (4 sides) Condition poor.
No inscription visible.
Relatively elaborate, ornamental, classical design with 4 'shields' one to each face.

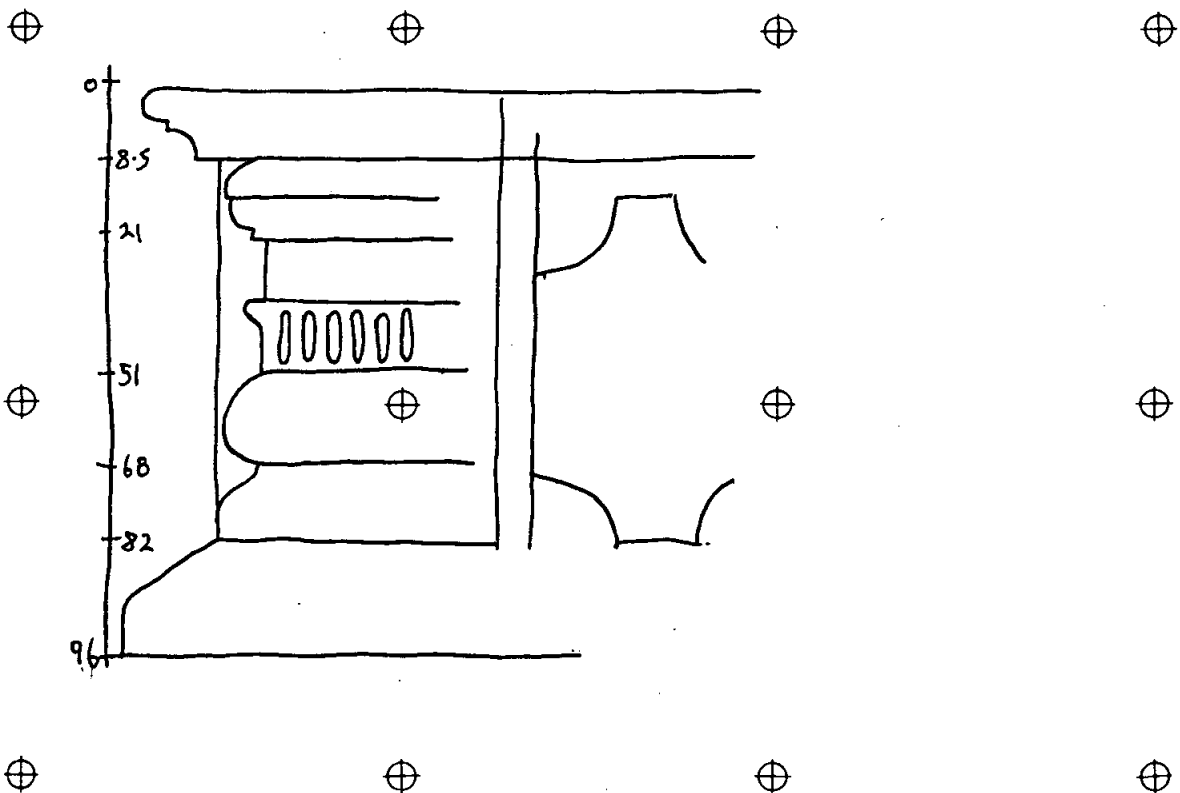

SITE ^{ST LUKES}
ISLINGTON
OLROD

CONTEXT RECORD ~~ADDITIONAL~~ SHEET

Context No.

3

Grave stone immediately to the south of [2]. Grave stone laid flush with ground surface. 186 x 91cm. Limestone. Poor condition and inscription almost totally illegible. "AND RACHEL" one of the very few legible bits.



SITEST LUKES
ISLINGTON
OLR00

CONTEXT RECORD ~~ADDITIONAL~~ SHEET

Context No.



4-sided, upstanding tomb, to north-east of church. 4 sides all with the same relatively simple design. Inscription on South face, little legible... ".... in her 6th year."

Inscription also to W face but stone soft/corroded, inscription illegible and stone to this face partly replaced.

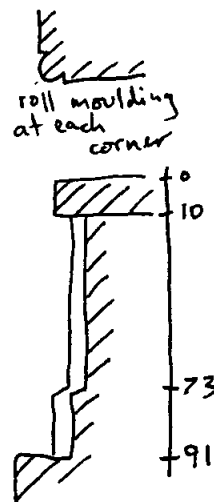
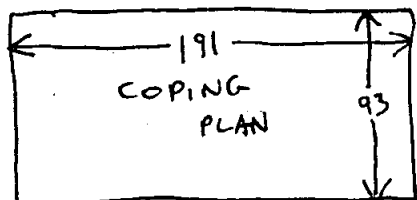
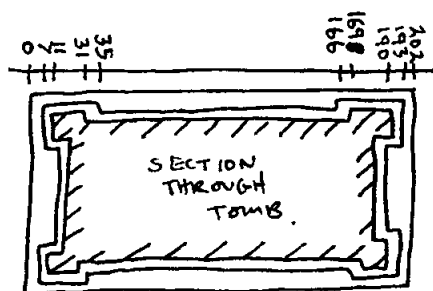

SITE ST LUKES ISLINGTON OLR 00	CONTEXT RECORD ARCHIVAL SHEET	Context No. 
--------------------------------------	--	--

Chest tomb to east of church, towards north end of church. Behind secondary(?) ~~to~~ protective railings.
Inscriptions to south and west faces, both almost totally illegible.
Coping 195cm x 91cm x 11cm
Limestone (?)
97cm tall.

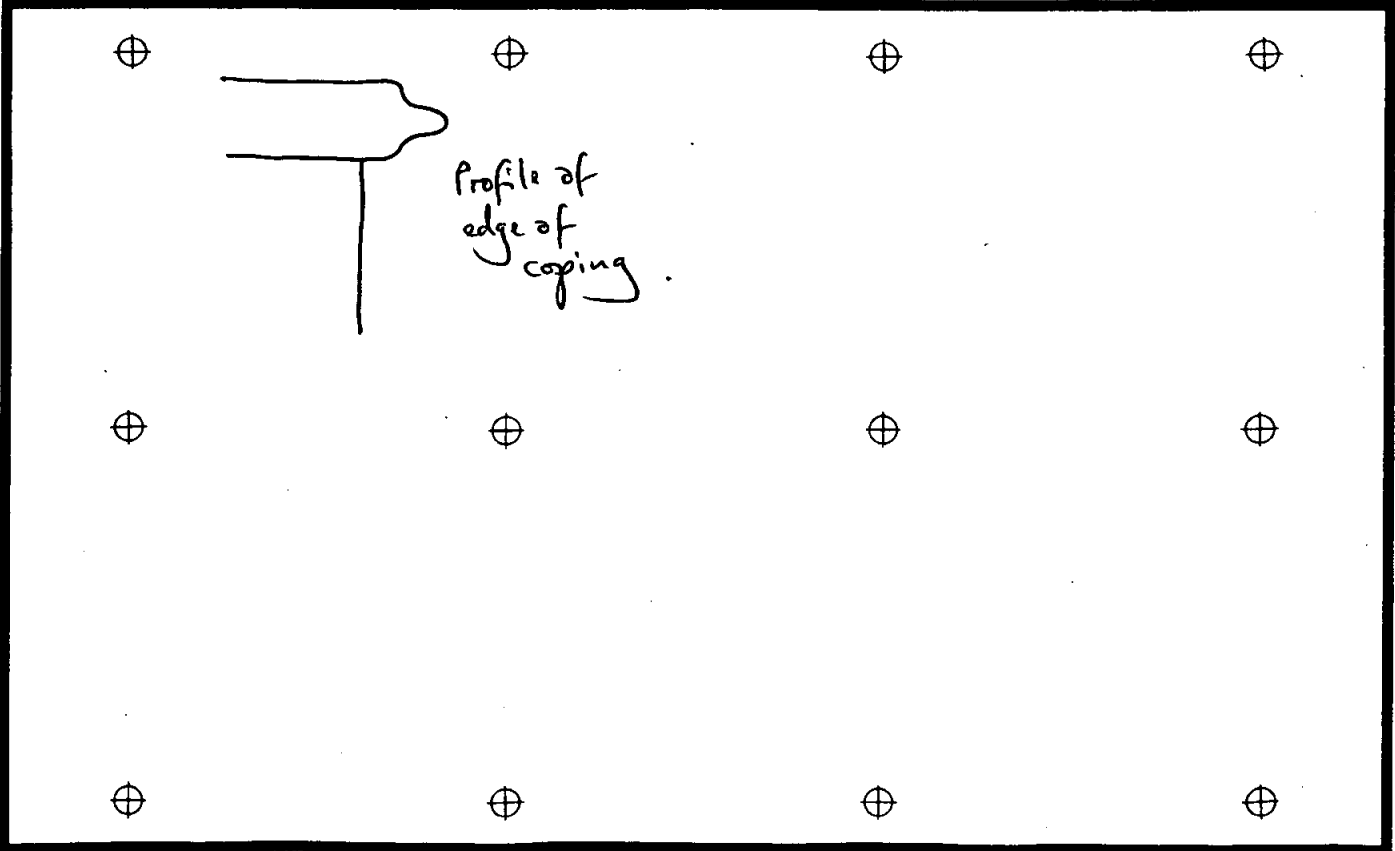

SITE St Lukes Islington OLROO	CONTEXT RECORD ADDITIONAL SHEET	Context No. 6
Chest tomb to south of church, behind protective iron railings. 210 x 103 x 108 (tall). Relatively elaborate, roll-moulded design.		
Inscription to N face — "Mary Anne Carlson, wife of Henry Carlson son of Henry and Elizabeth Carlson born August 21st 1785 died March 31st 1816. Sacred to the memory of Henry Carlson esq of Higham Hill, Walthamstow, Essex only surviving child of Henry Carlson and Elizabeth, eldest daughter of William Rowl esq of Higham Hill. Born in Gower St London May 15th 1786 died at Boulogne sur-mer May 28th 1850"		
Inscription to top — "William Carlson esq died Jan 23rd 1766 aged 74 years. Also. William Carlson esq son of the above died Aug 17th 1778 aged 58 years. Also. Miss Elizabeth Mary Carlson daughter of William and Elizabeth Carlson and grand daughter to the above William Carlson esq who died Oct 30th 1780 aged 7 months and 18 days. Also. Mr Thomas Carlson son of the above William Carlson died March 29th 1783 (?) Aged 56 years.		
Also	Miss Harriot Carlson daughter of Henry and Elizabeth Carlson	
and ⊕ grand daughter to the ⊕ above William Carlson ⊕ who died May ? 1785 aged 2 months and 9 days. Also Edward Carlson son of the ⊕ above Henry and Elizabeth Carlson died Oct 20th 1787 aged 12 weeks and 3 days. Here lyeth the body of Elizabeth Carlson widow of William Carlson esq the son of William Carlson senior esq who died Oct 24th 1795 aged 65 years.		
⊕ ⊕ ⊕ ⊕		

SITE ^{Lyles Islington} OLROD	CONTEXT RECORD ADDITIONAL SHEET Sheet No 2	Context No. 
--	--	--

Inscription to south face — " Thomas Hanby esq late of Hackney died Dec 1786 Aged 74 years. Here lyeth the body of Mary widow of the above named Thomas Hanby esq who died 14th day of January 1797 aged 75 years ~~and~~ also of Godfrey Shewell late of this parish and likewise daughter of William Carlson senior esq formerly of this parish "

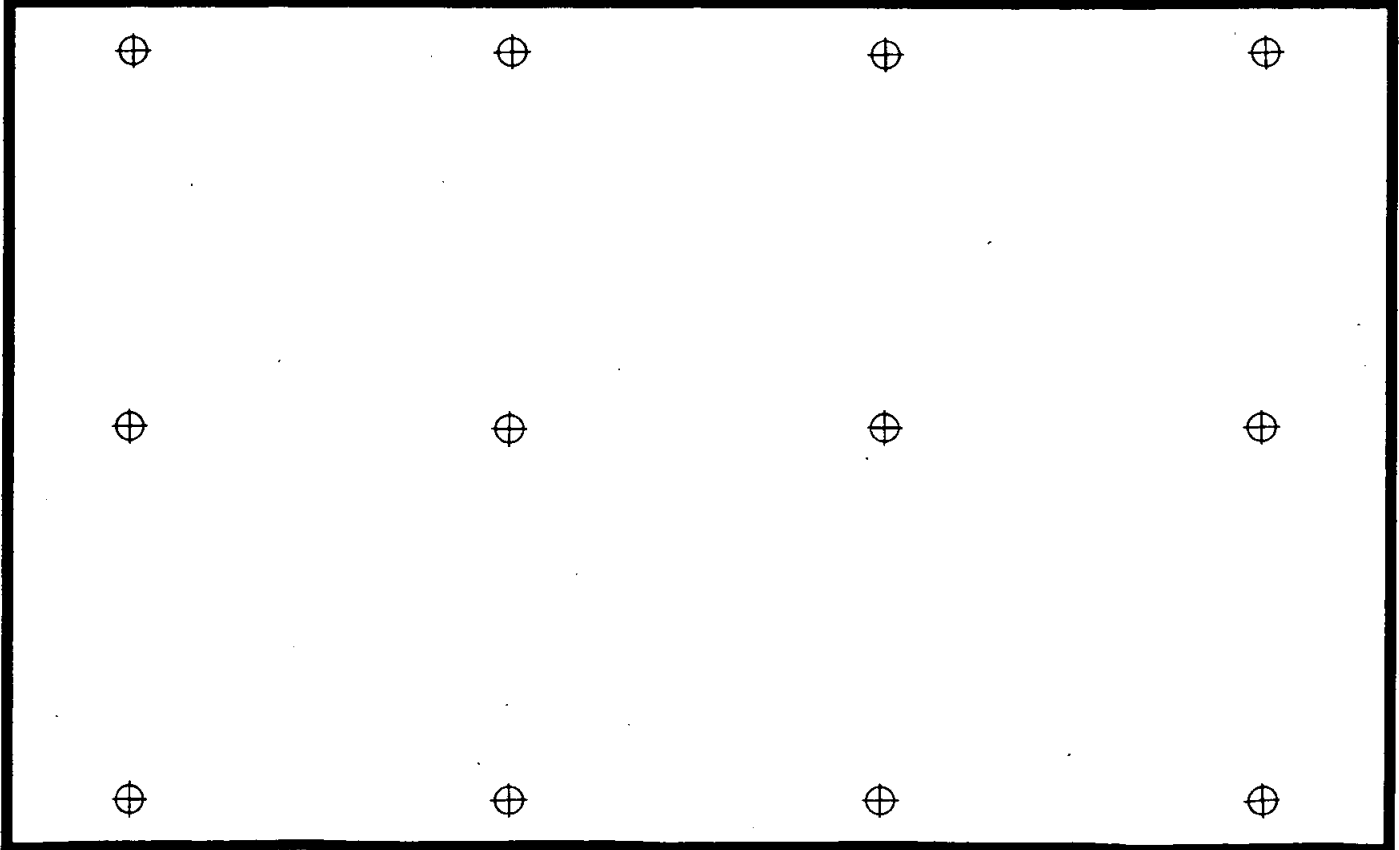

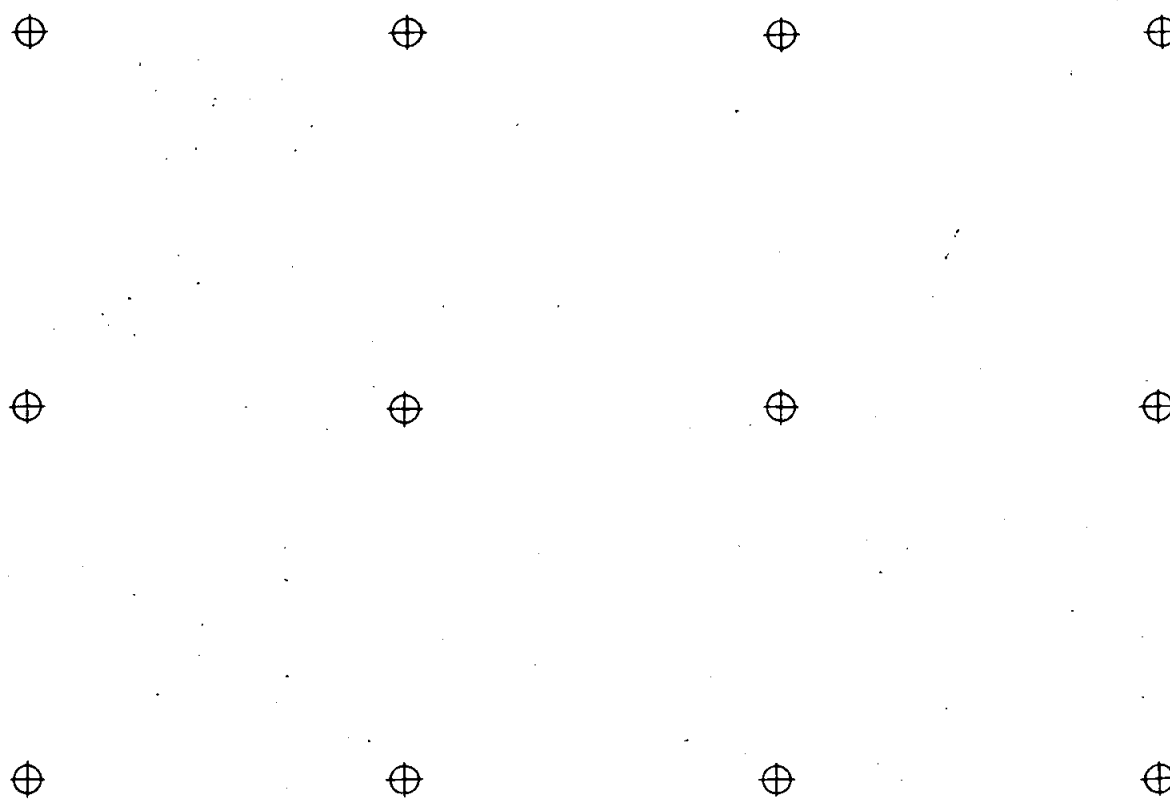
SITE OLR00 ST LUKES, ISLINGTON	CONTEXT RECORD ADDITIONAL SHEET	Context No. 7
<p>Overall crypt. 4 bays wide (aligned E-W) brick-built. 3 spine walls each one with 3 vaulted openings in line other openings. Primary mortar soft, white. Southernmost bay not used for burials, other 3 bays used for burials and floor level consequently significantly (c. 1m) higher. The 3 bays used for burials contain many individual vaults 'family' vaults apparently all in early - mid 19th (suggested by name plaques + memorials). Each bay barrel vaulted. Two outer 'spine walls' (ie between bays 1+2 and 3+4) buttressed by red primary buttresses (36cm deep). Some of these appear to have been removed and those at SE corner of building replaced/enveloped by larger modern brick buttress.</p>		
		

SITE ST LUKES
ISLINGTON
~~12600~~ OLROD

CONTEXT RECORD ~~ADDITIONAL~~ SHEET

Context No.



8

Individual ^{burial} Vault at E. end of Bay 4. Brick, painted white, with medium soft white mortar. Clearly abuts barrel vault and slightly coming away in parts. Two, projecting 'entrance' piers with wrought iron grille between. Grille consists of vertical circular section bars and 4 horizontals, one at $\frac{2}{3}$ height & 2 towards base and top, orched bar. 5 bars from largest section removed, presumably by grave-robbers. ~~Wall~~ Front wall to N at right angles to spine of crypt, wall to south angled ~~to~~ so as not to abut the now-blocked opening to Bay 3. Wall to N abuts what appears to have been a former opening in N, 'external' wall although the 'blocking' mortar + brick is v. similar to pining mortar. Circular, former opening in E wall, within vault, v. similar to that at E end of Bay 1. This one blocked with modern brick + cement mortar. Iron lining encircling inner face of opening still in situ. No memorial/inscription survives. Feature possibly early 19th.

Bress vault plaque retrieved during demolition reads:

"THE FAMILY VAULT OF J & H CLARKE 1825"

(Containing: 1218, 1219, 1220, 1221, 1222, 1223, 1257, 1258, 1259, 1260 & 1261,

vault has unworked brick floor.

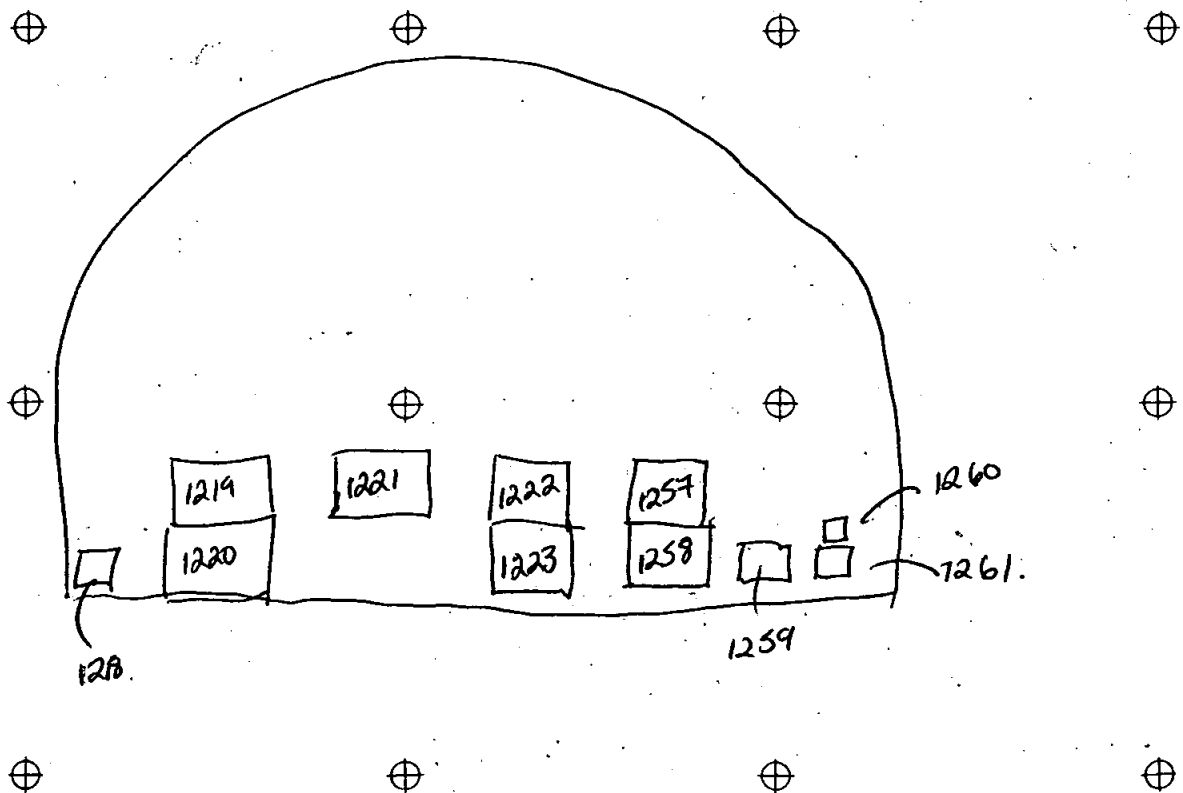

SITE ^{OR 200} ST. MIKES WILKINGTON	CONTEXT RECORD ADDITIONAL SHEET	Context No. <div style="border: 1px solid black; padding: 2px; display: inline-block;">8</div>
---	---------------------------------	---

ADDITIONAL INFO:

- 1218 - SARAH HYDE CLARKE, 1826, 9 MONTHS + 8 DAYS. (MISS)
- 1219 - MARTHA BURTON, 1848, 71 (MRS)
- 1220 - SUSANNAH CLARKE, 1815, 33/83 (MRS)
- 1221 - CAROLINE JA... , ? , 31? (MRS)
- 1222 ~~1222~~ - NO NAME
- 1223 - ROLAND WILKES, 1839, 38 (MR)
- 1257 - JOSEPH CLARKE, 1833, 60 (MR)
- 1258 - WILLIAM HENRY CLARKE, 1822, 89? (MR)
- 1259 - EDWARD CLARKE, 1828, 10 YEARS + 7 MONTHS (MASTER)
- 1260 - NO NAME.
- 1261 - ALFRED CLARKE, 1815, 10 MONTHS (MASTER)
- ~~NONEXISTENT~~
-
-
-
-

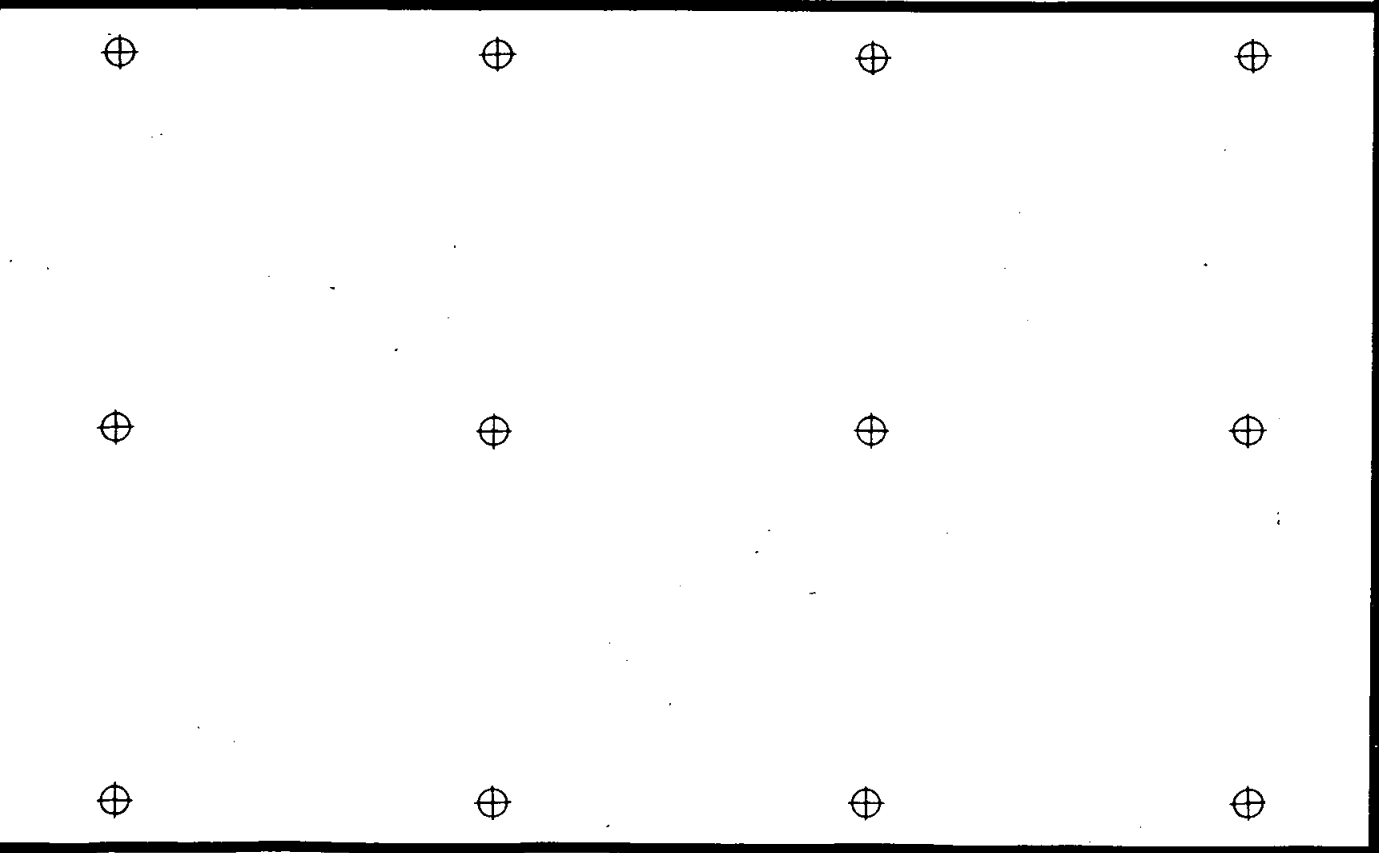

SITE ST LUKES
ISLINGTON

CONTEXT RECORD ~~ADDITIONAL~~ SHEET



Context No.

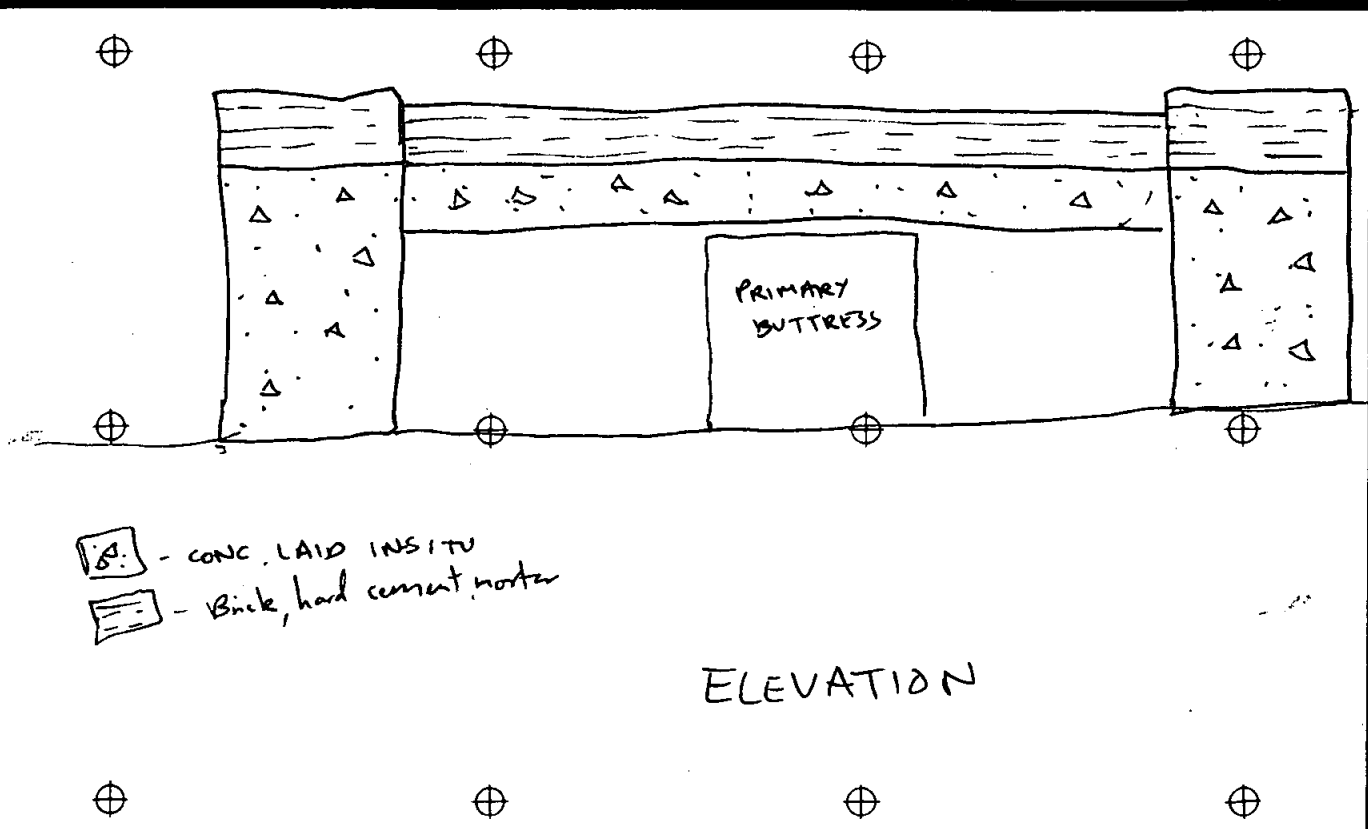

~~1200~~ 01200

Modern (mid 20th?) feature apparently added as buttress to support subsiding structure. Projects 93 cm from primary wall. 2 conc piers support conc beam and modern bricks on top. Located in Bay 4 on S. wall, towards East end. Abuts originally open door to Bay 3. Acro props + timber beam on floor adjacent, probably used to prop ^{vault} structure while it was constructed.



-  - CONC. LAID INSITU
-  - Brick, hard cement mortar

ELEVATION

SITE ST LUKES
ISLINGTON

CONTEXT RECORD ~~ADDITIONAL~~ SHEET

Context No.

10

~~to 100~~ OLROO

'Boiler room' at W end of Bay 4. - Not boiler just pipes with large heating flanges. W wall and N wall formed of modern brick (post-dating the pipes) with mod cement. S wall primary brick



SITE ^{ST LUKES}
ISLINGTON
~~1800~~ OLLOO

CONTEXT RECORD ~~ADDITIONAL~~ SHEET

Context No:



Small private vault at ^W end of Bay 3, N side. Brick, hard grey graining mortar, inner faces rendered. Iron strap ties it to primary buttress. Structure come almost totally away from primary vault. Memorial stone on W face - Matthew Little, died 3rd March 1808 Aged 6 months.

Vault broken open at W end, above memorial.

containing burial 337;



SITE St Lukes
ISLINGTON
~~15250~~ OLROD

CONTEXT RECORD ~~ADDITIONAL~~ SHEET

Context No.  

Private vault, brick, medium hard white mortar. Large opening at in E face, presumably for memorial stone no longer in-situ. Stone lintel above former memorial, timber lintel immediately behind it.

Located at W. end of Bay 3.

Simple rectangular plan.

containing burials 301; 302; 303; 304;

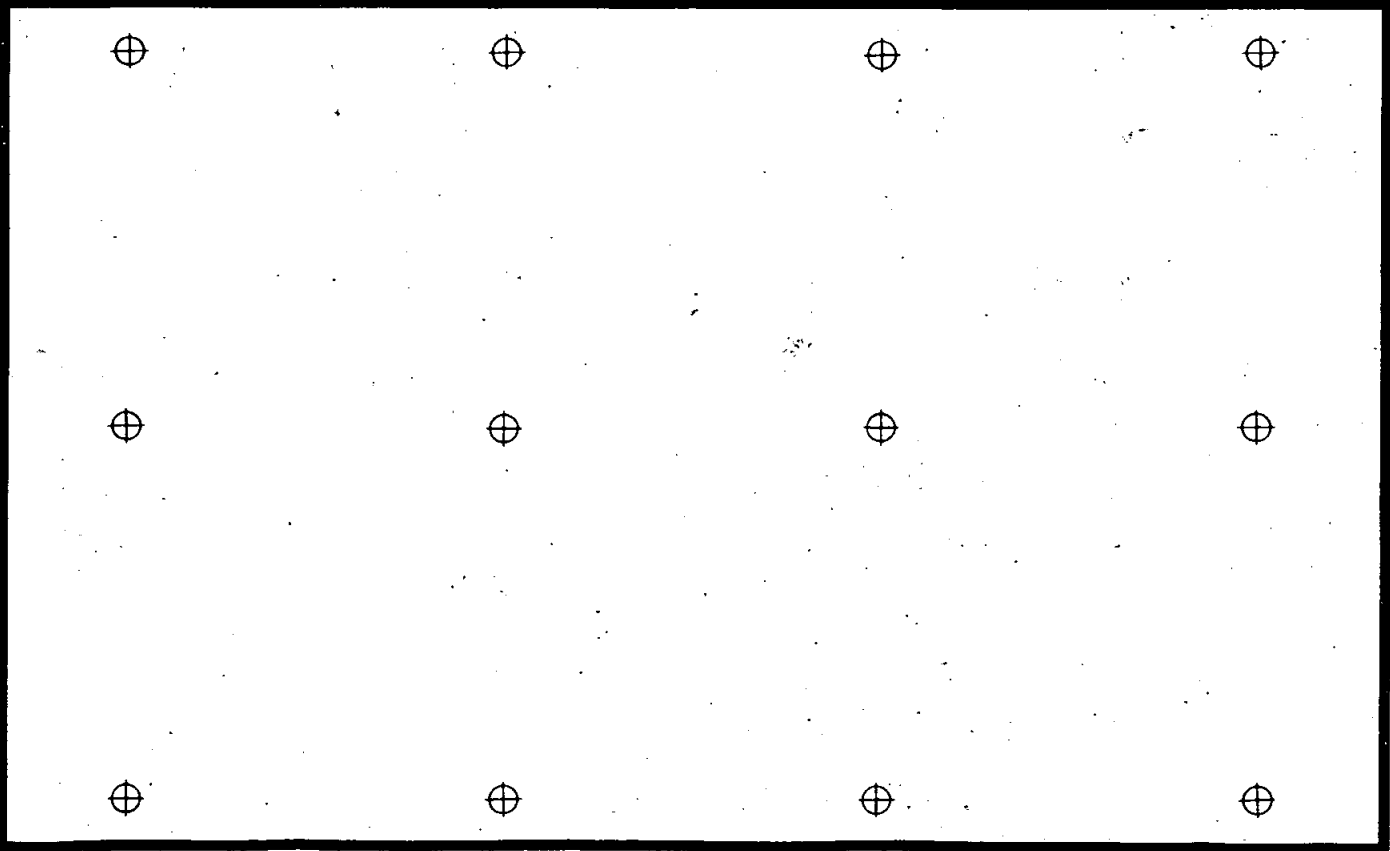

SITE ^{ST LUKES} ISLINGTON 1000 OLLOO	CONTEXT RECORD ADDITIONAL SHEET	Context No.  
--	--	---

Skil-sealed private vault at W. end of Bay 3. Red brick, medium-soft whiteish mortar. E wall abuts two adjacent private vaults. Large (170cm x 90cm) memorial stone in wall. In upper third "M. Bowes Todd, Late of FIRSHURN (???) PLACE who departed this life Aug 8th 1800 Aged 32 years. Rest of stone blank. - The address is v. faint and Firshurn is a guess.

containing only sk 350. sitting on 2 x brick row runners with a timber on each, see sheet for sketch.

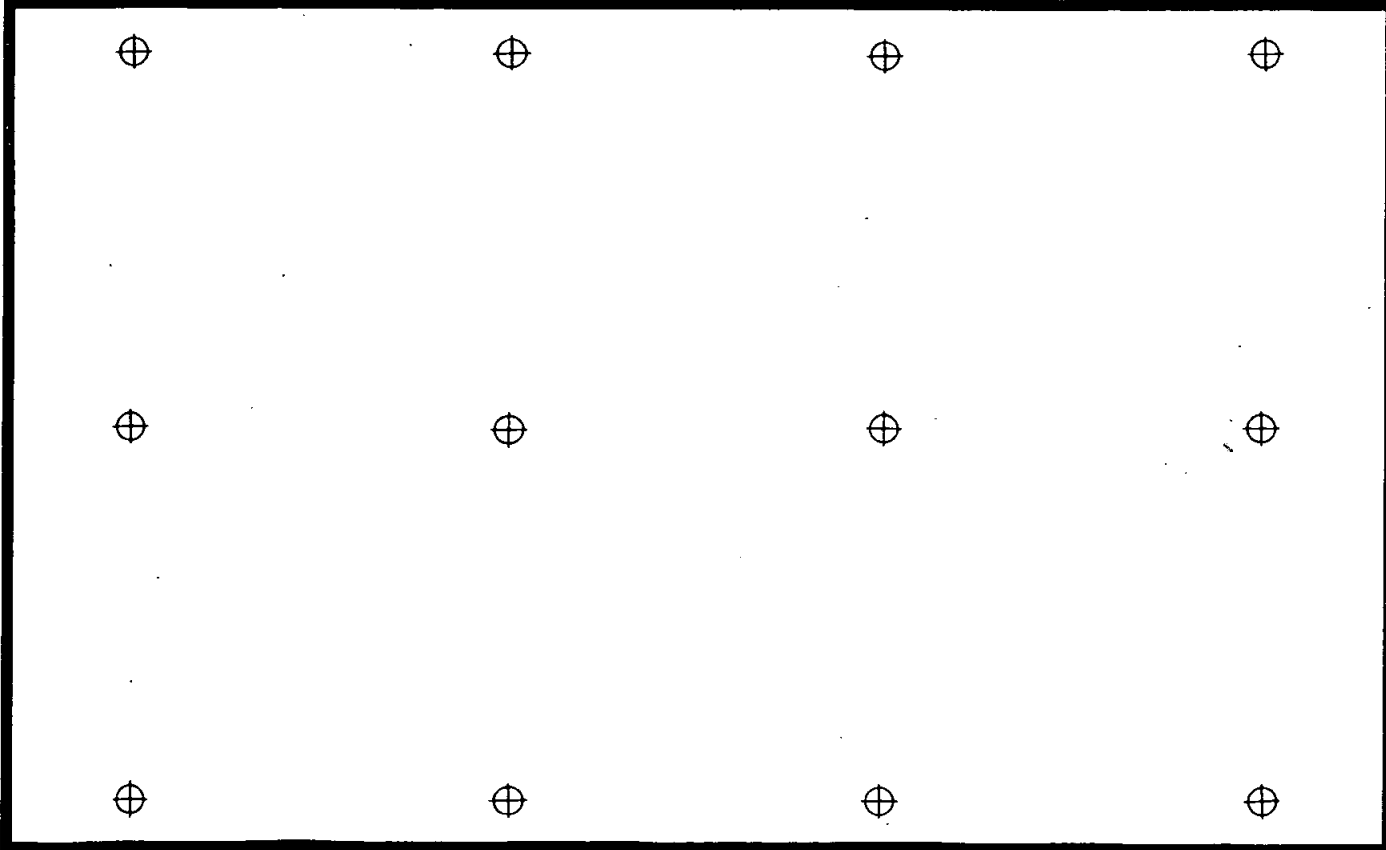

SITE ST LUKES
ISLINGTON
~~12200~~ OLROO

CONTEXT RECORD ~~ADDITIONAL~~ SHEET

Context No.



Private vault. Brick, medium hard white mortar. Doorway (184x91cm) in E wall. Door removed but latch in iron frame inside. Iron frame inside with decorative vertical twirls in head. Stone lintel with 'Charles ~~son~~ Cuerton' inscribed. Coffins removed.



SITE ST LUKES
ISLINGTON
~~20200~~ OL200

CONTEXT RECORD ~~ADDITIONAL~~ SHEET

Context No.



Private vault at W. end of Bay 2. Large opening (106 wide) created in E wall. Walls rise to barrel vault. Small decorative 'vent' above opening (and above memorial) "The family vault of Tho: Hughes 1818" inscribed on stone memorial

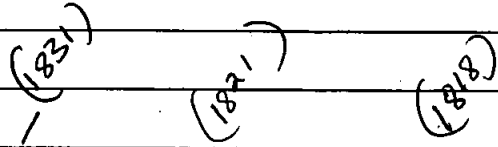
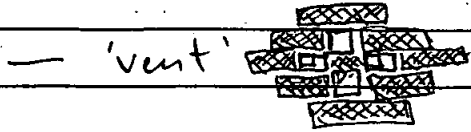

containing burial 305; 306; 307; 308; 342; 343; 344

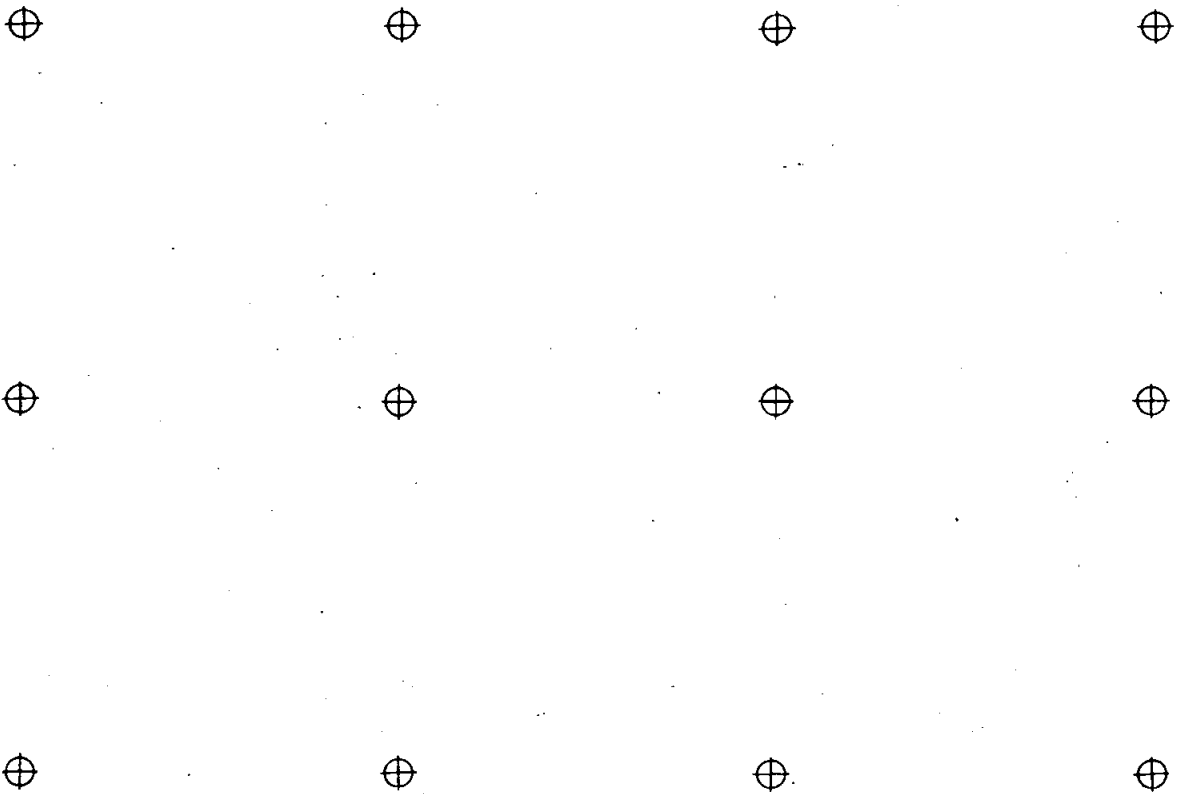
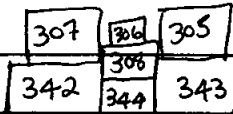

SITE St Lukes
Islington

CONTEXT RECORD ~~ADDITIONAL~~ SHEET

Context No.



~~2222~~ OLROO

Private vault ~~at~~ towards W. end of Bay 3. Brick, painted white, inside + out, medium-hard white mortar. Door opening 160x95cm in W wall. Iron grille door inside with name plaque (copper?) in-situ inscribed "Family vault of (Geo George) Hathorn Esq, Brunswick South. Stone lintel above doorway.

Vault has brick floor w/ 2 x timber runners (N/S), vault not built/tied into crypt wall/ceiling - butts the main structure.

containing 5x burials; 362, 363, 364, 465, 466.

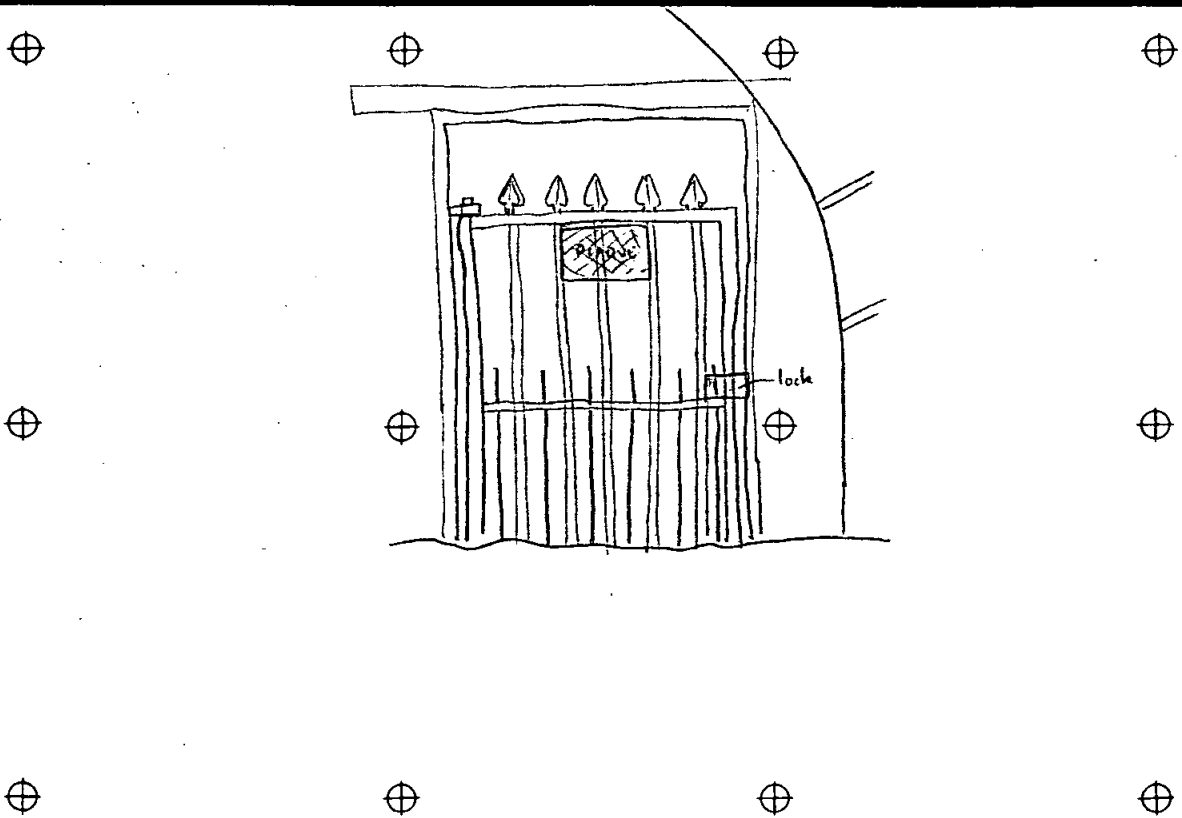
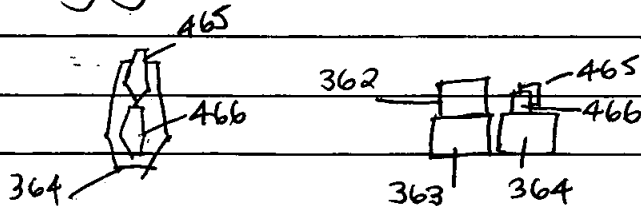

SITE ^{ST LUKES} ISLINGTON 10/10/00	CONTEXT RECORD ADDITIONAL SHEET OLR00	Context No. 
---	---	--

Former private vault, now demolished down to ground level.
Single skin brick, hard white mortar. Brick painted. Primary brickwork
behind vault not painted, unlike the open areas suggesting the vault was
only painted after construction of this vault.

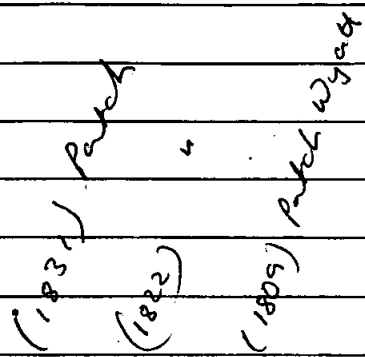

containing burials 339; 340; 341.

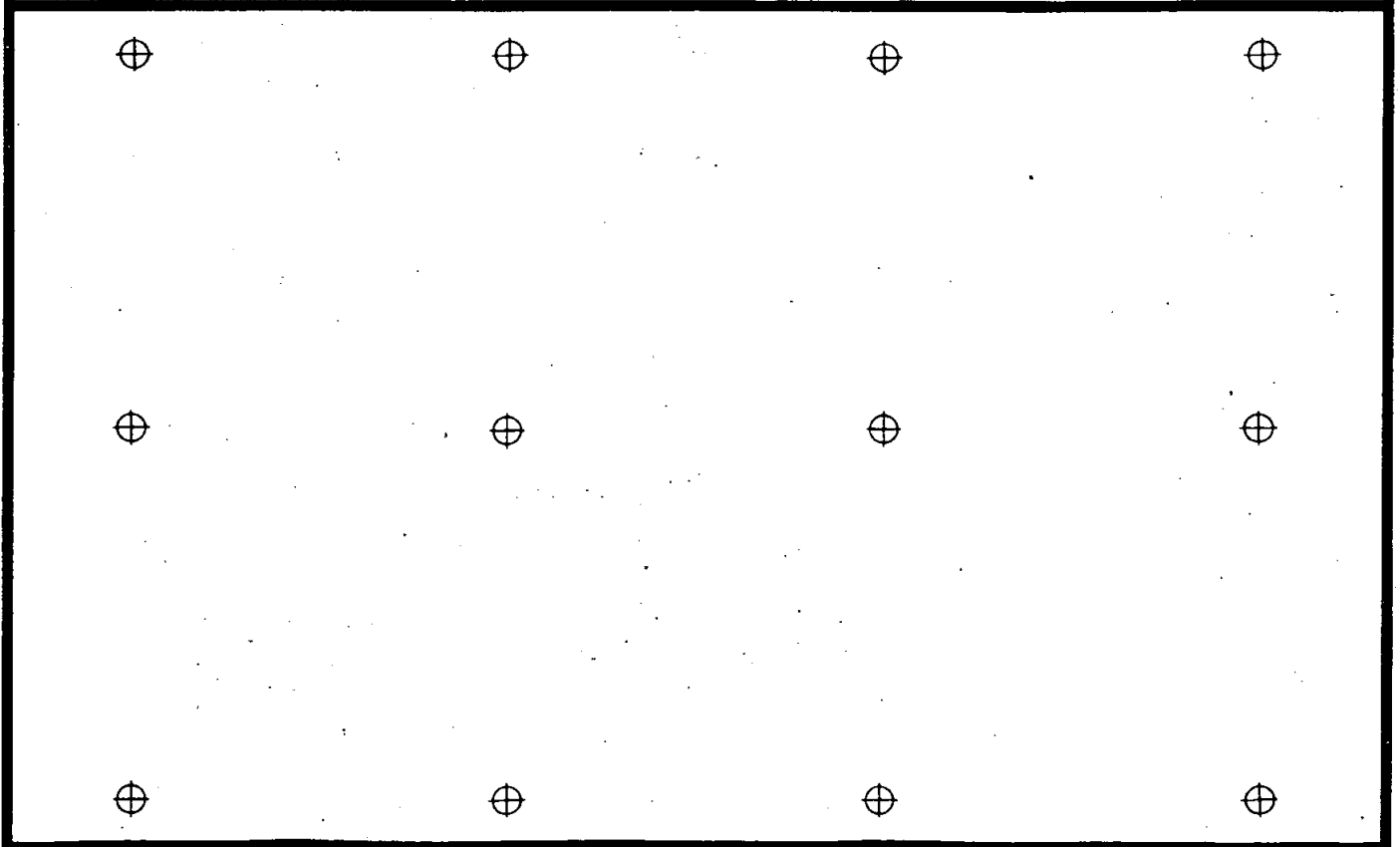

Private vault. Brick-built, medium hard white mortar. Doorway 91cm x 136cm - stone lintel with 'Mr W. Sutton's vault 1831' inscribed. Iron door frame in-situ and iron grill-door off-its hinges but almost in-situ.

Vault construction cut away original support pillar for EXHIBIT BAY 3 (SEE SKETCH PLAN) AND INTO EASTERN ENTRANCE-WAY TO BAY 4 (LINTEL FOR DOORWAY TO VAULT IS CUTS INTO BRICK-WORK) THIS LEFT BY REMOVAL OF SUPPORT PILLAR RECAST WITH HARD WHITE MORTAR. CONSTRUCTION OF VAULT CONSISTED OF FREE-STANDING THREE WALLS, ATTACHED BY TO ORIGINAL BAY CONSTRUCTION BY ONE IRON SQUARE SECTION BAR AFFIXING TO HARD WHITE MORTAR WITH PUGGED HOLE IN WALL AT 800 WEST OF VAULT (APPROX 1.5m ABOVE ORIGINAL FLOOR LEVEL OF VAULT) AND AT VAULTS LINTEL, WHEREIN SOME ORIGINAL BRICKWORK HAD BEEN REMOVED AND REPLACED BY TIE-IN BRICKS FOR EASTERN VAULT WALL (ONLY ABOVE DOOR LINTEL).

BOTH EAST & WEST WALLS ARE OF ONE BRICK THICK CONSTRUCTION, SOUTHERN WALL IS TWO BRICKS THICK. DIRT FLOORED VAULT. SOME REMAINS (APPROX 0.20m) OF SUPPORT SLAB (OR SUPPORT PILLAR STILL EXIST WITHIN VAULT).

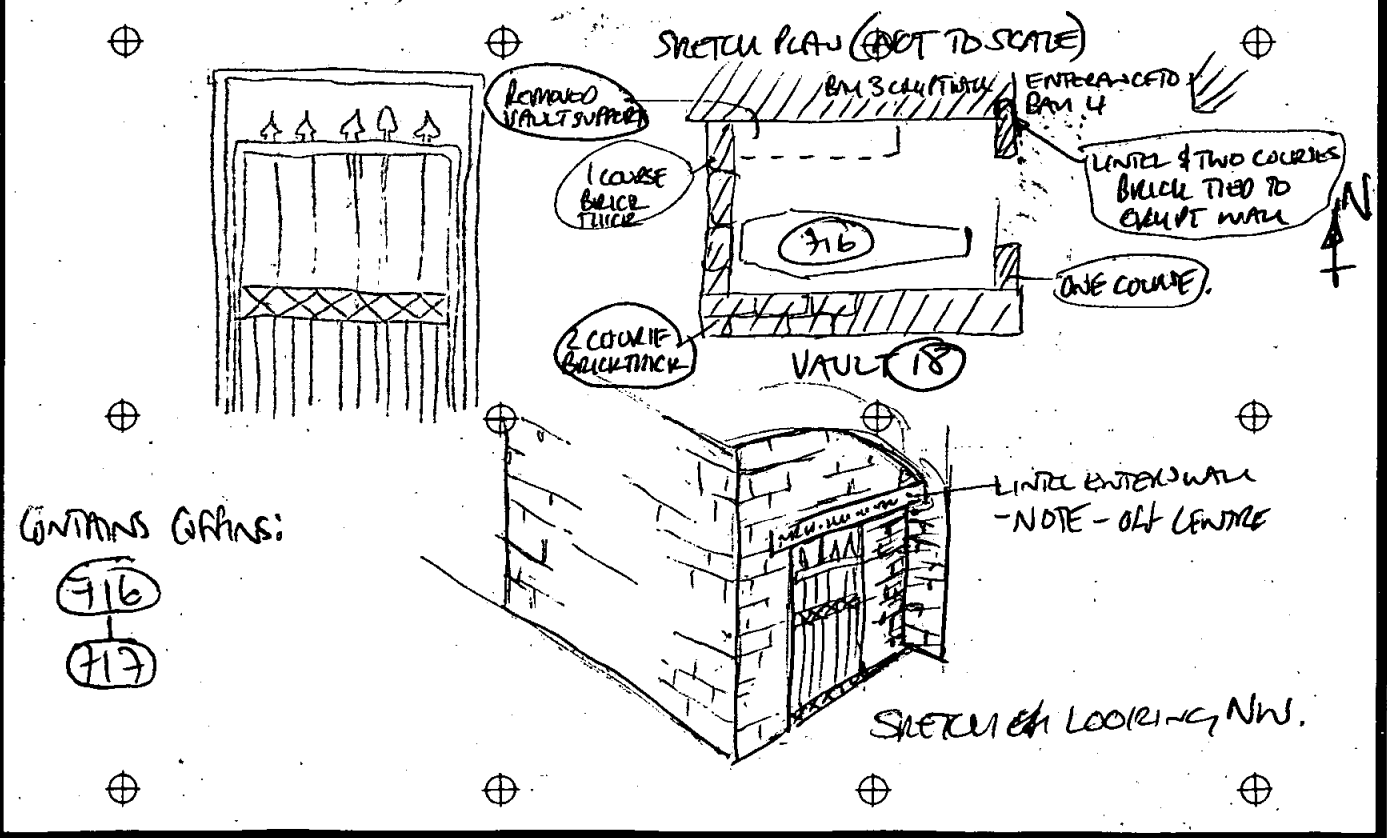

SITE <u>ST. LUKE'S</u> <u>WINSTON</u> <u>WIMBORNE</u>	CONTEXT RECORD ADDITIONAL SHEET OLROD	Context No.   19
---	---	--

Private vault on N side of Bay 3. Brick, painted white, medium weight white mortar. Stone lined in W face immediately above memorial and straight joints either side beneath this - i.e. 2nd body added after first construction.

Memorial - "The private vault of the Revd Trefusis Lovell, rector of this parish; in which are deposited the mortal remains of Margaret, his beloved ~~wife~~, virtuous, lamented wife; who died on Sunday June 25th 1837 aged 64 years. Also to the memory of the Revd Trefusis Lovell MA for upwards of thirty years Rector of this parish; and formerly archdeacon of Derry Ireland who ~~deceased~~ departed this life October 10th 1841 in the 78th year of his age.

Vault still sealed although a ~~small~~ number of bricks have come away at ~~the~~ E end and subsidence has caused large ~~cracks~~.

CONTAINS TWO COFFINS STACKED ON TOP OF EACH OTHER (SEE SKETCH SECTION), Nos 855, 856. N.B. VAULT BUILDING NOT INVOLVED REMOVAL OF CRYPT SUBJECT TO 4 COURSES HIGH (SEE SHADOW ON PLAN 7).

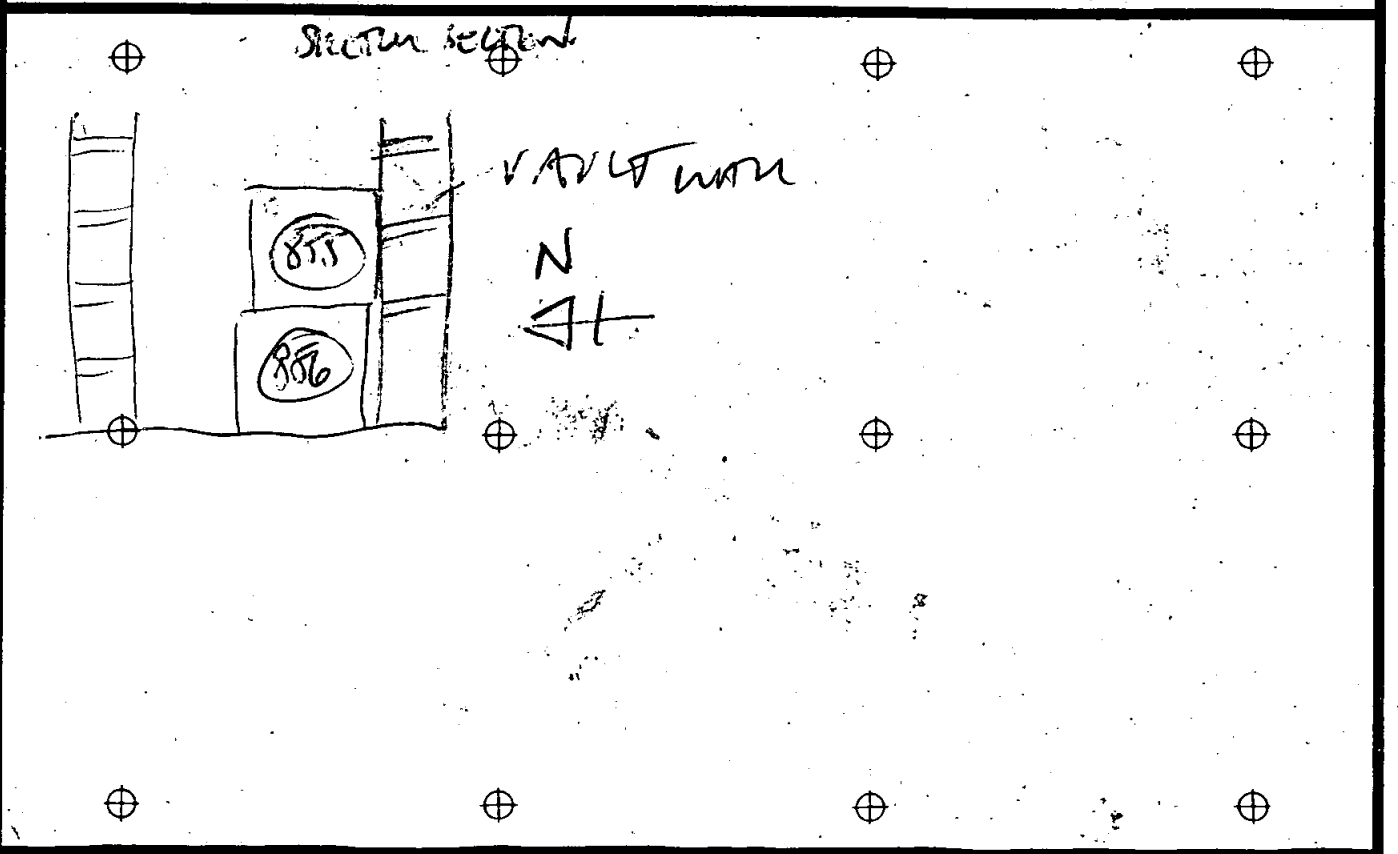

SITE ST LUKES ISLINGTON 100/1000	CONTEXT RECORD ADDITIONAL SHEET OLROD	Context No. 20
---	---	-------------------

Private vault on N wall of Bay 3. Yellow brick, unpainted externally. Internally 2 secondary walls either faint paint or v. stained/discoloured; primary arched wall plastered. Large (105cm x 63cm) stone plaque on S wall. Upper half "Mrs Mary Ann Robinson Wife of Mr E Robinson died the 5th of May 1838 in her 40th year." Lower 2/3's blank.

Central pillar has been removed to construct vault (still visible on other side of wall (A114)). - probably explains why internal wall of vault plastered to make good.

Burials:- (972) (child) above (973) - which is the burial recorded on the external slab

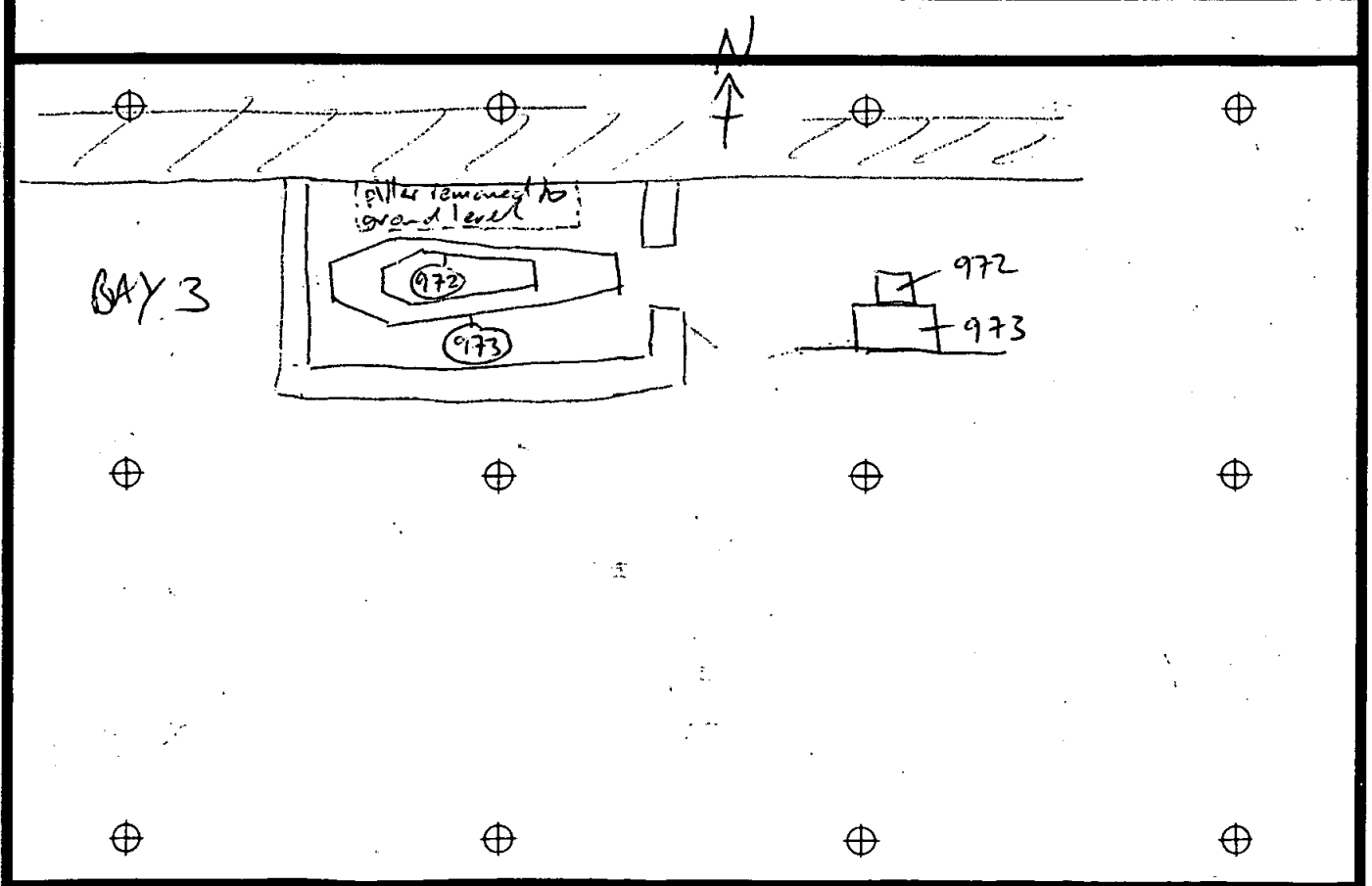

SITE ST LUKES
ISLINGTON
~~WARRING~~

CONTEXT RECORD ~~ADDITIONAL~~ SHEET
CLR00

Context No.

21 

Private vault at E end of Bay 3. Brick, Medium hard white mortar. External faces painted white, internal not painted. Timber lintel creates opening 106cm wide at W end. No door or memorial. Subsidence has caused it to come right away from main barrel vault.

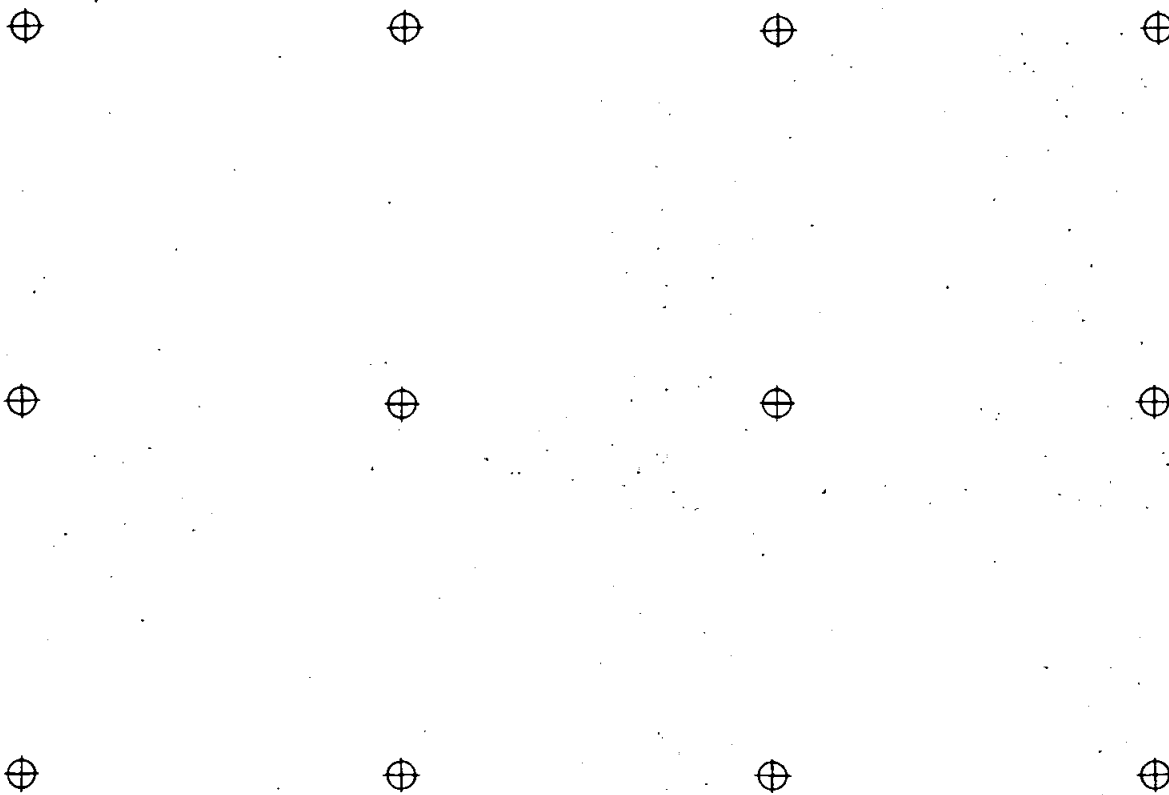

SITE ST LUKES
ISLINGTON
~~01800~~

CONTEXT RECORD ~~ADDITIONAL~~ SHEET
01800

Context No.   22

Private vault at E end of Bay 3. Brick, medium hard mortar (white). Timber door frame (95cm wide). No door or imbricoid in-situ. Timber bearer set in wall (N) internally at 110cm above current floor.



SITE ^{ST LUKES} ISLINGTON 12/2/00	CONTEXT RECORD ADDITIONAL SHEET OLR00	Context No. 23 
---	---	---

Private vault towards E end of Bay 3, against S wall.
 Brick, whitewashed, pretty hard white mortar. ~~at~~ 'Access' would have
 been at E end - stone lintel 126 cm above existing floor, straight joint
 either side brick similar both sides of joint.

Stone memorial plaque on N face - "John Capron of Finsbury
 Square died 18th May 1833, Aged 78 years" - in upper half
 of plaque, lower half empty.

2 simple wrought iron ties built $\frac{1}{2}$ within side walls fixing them to
 primary vault.

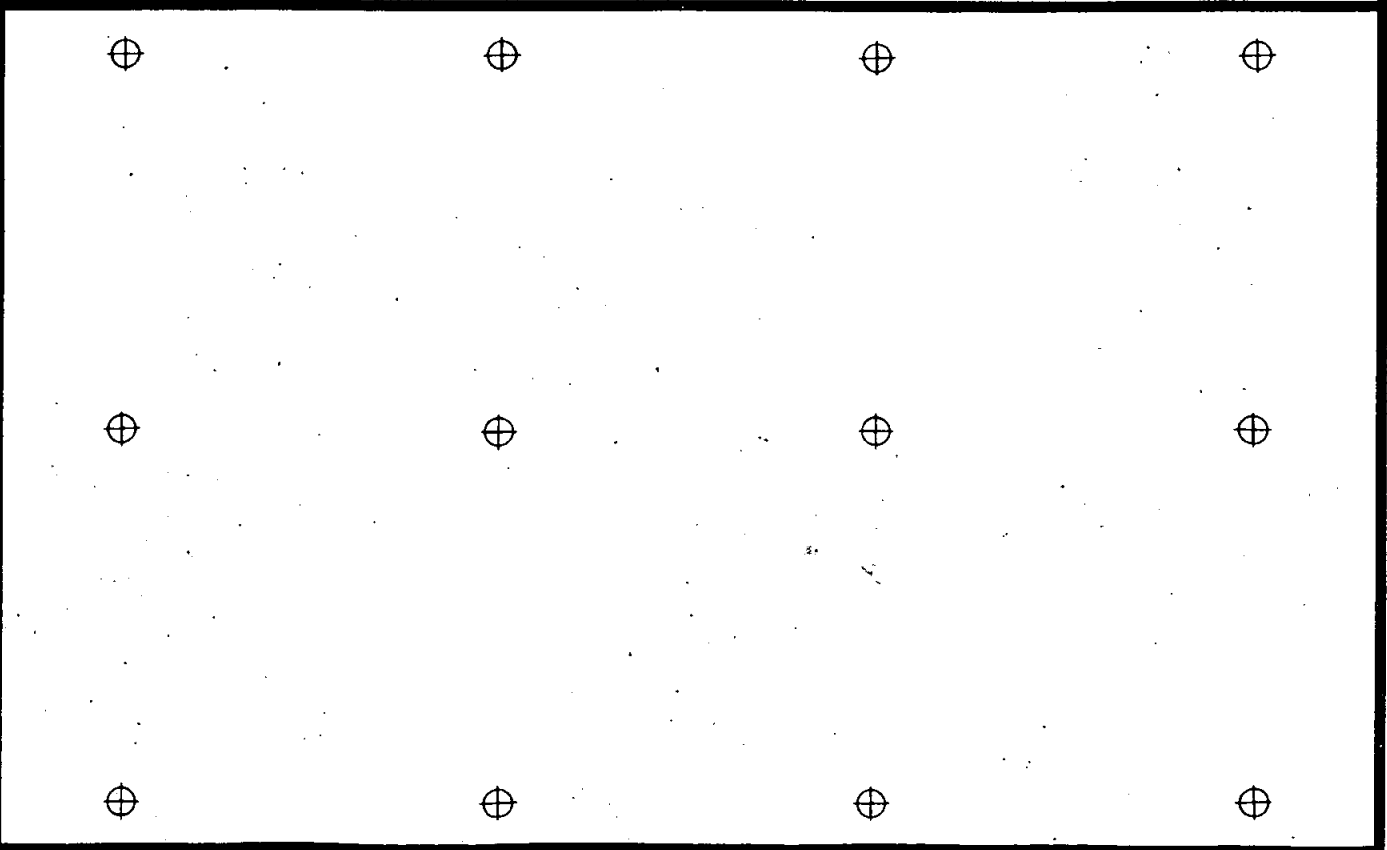

SITE ST LUKES ISLINGTON OLR00	CONTEXT RECORD ADDITIONAL SHEET OLR00	Context No. 24 
--	---	---

Small private vault at E end of Bay 2. Medium soft grey mortar, brick-built. Wooden door lying on floor apparently collapsed directly from existing opening. Condition poor, little struct surviving.

containing 1196 'Robinson Turner'.

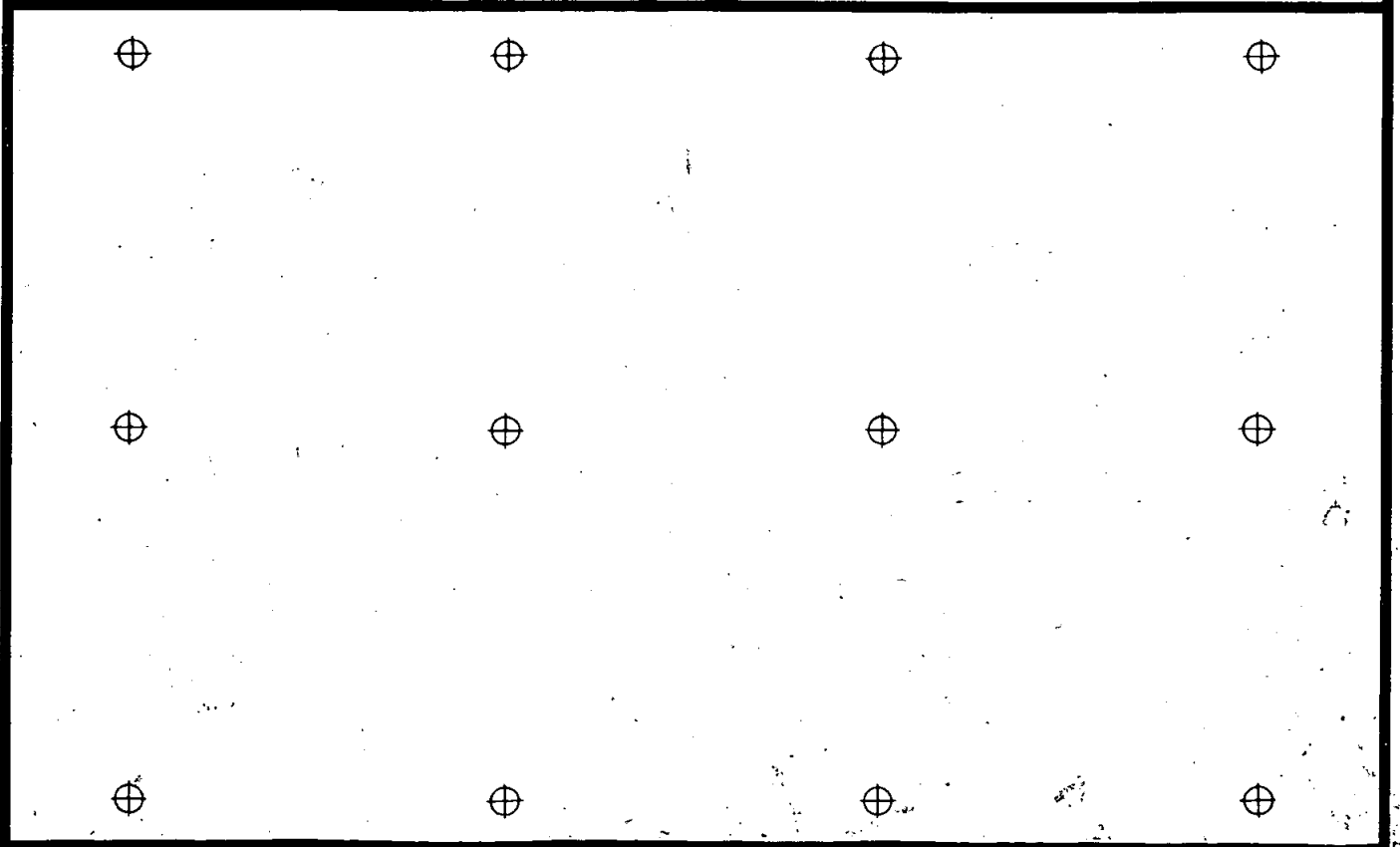
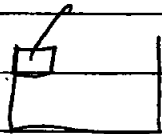

SITE OLR00	CONTEXT RECORD ADDITIONAL SHEET	Context No. 25
---------------	---------------------------------	-------------------

Private vault ~~at~~ towards E end of Bay 2: Yellow brick, fairly hard white mortar. Stone memorial on S face (68cm x 106cm) - "Thomas Dalton esqre died December 3rd 1846 in his 85th year. Elizabeth Harrison Grand Niece of the above died November 17th 1852 in her 42nd year!"

Iron-barred gate in-situ in E wall - v. simple 8 vertical bars, 6 innermost circular section 3 horizontals; at top, bottom and $\frac{2}{3}$ of way up. Stone lintel over it inscribed "The family vault of Thos Dalton esq." BRICK FLOORED VAULT (BRICK REINFORCING N-T'S CONSTRUCTED WITHIN VAULT) CONTAINING TWO COFFINS WHICH MATCH VAULT INSCRIPTION: COFFINS 770, 771.

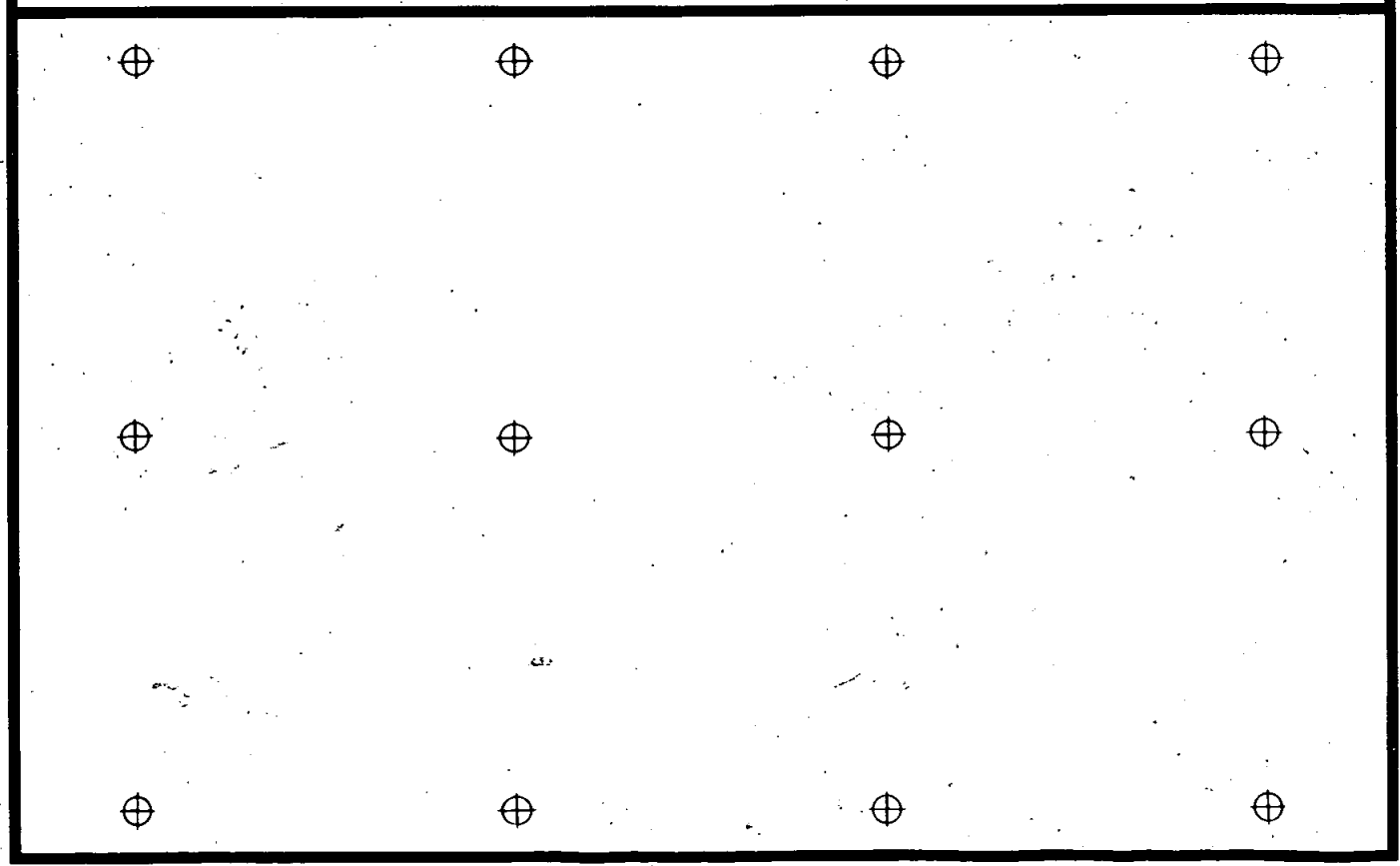

SITE ST LUKES
ISLINGTON

CONTEXT RECORD ~~ADDITIONAL~~ SHEET

Context No.

26



~~82800~~ 02100

- Private vault. Medium hard white mortar. Timber lintel forming opening 109 wide. Lintel supports lots of bricks, straining somewhat. 'vent' at S side just beneath main barrel vault - 4 holes \square \square . Large space for plaque above opening. Stone memorial on floor, almost certainly relates to the space, same size (76 x 59cm) - "Within this vault lies the body of Wm Dore Obit Oct 21 1816 Aged 32. Mary Dore Obit May 6 1817 Aged 4 years, Mary Dore Obit Jan 8 1821 Aged 40 years".

CONTAINS 4 COFFINS; 3 X ADULT, 1 X INFANT (SEE SKETCH SECTION BELOW) COFFINS NOS 840, 841, 842, 843 - NOTE NO OF LB COFFINS NOT MATHS AMOUNT (3) ON VAULT INSCRIPTION

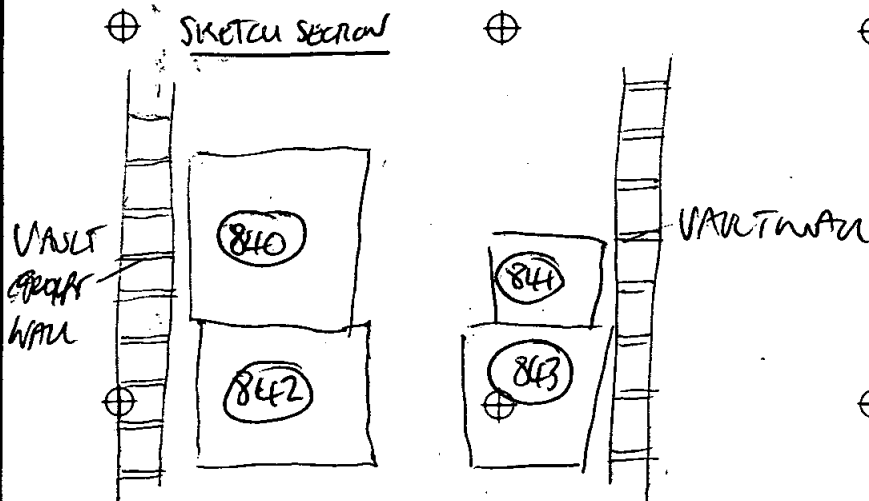

SITE ST LUKES
ISLINGTON
~~2020~~

CONTEXT RECORD ~~ADDITIONAL~~ SHEET
0100

Context No.



Vent in South wall of church providing air into Bay 1. Apparently part of primary structure, stone lintel creates opening within external face of church wall - opening 62cm wide x 75cm tall. 50cm ~~deep~~ wide well adjacent to the opening with stone + brick-lined walls which would presumably have supported a grille over the top.

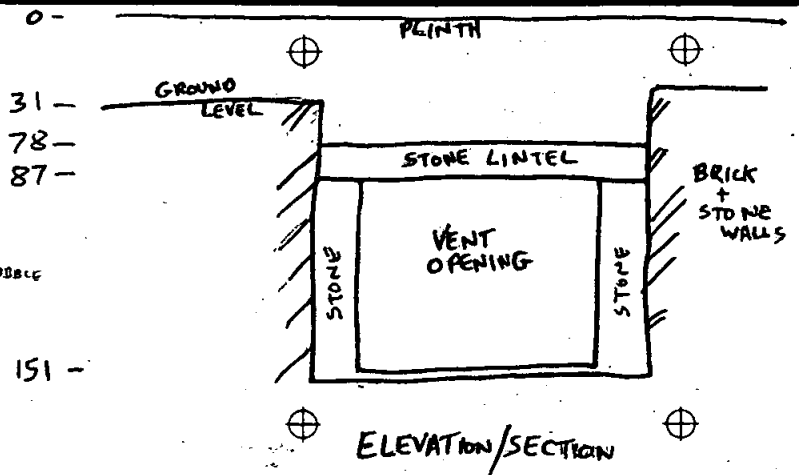
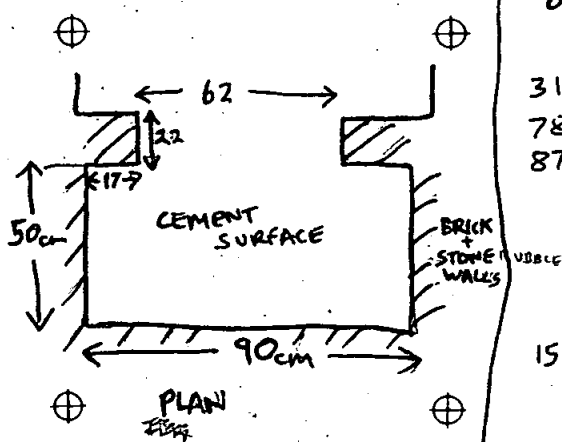

Islington, Old Street, St Lukes
OURCO

Box 2 File 3

B PRIMARY CONTACT RECORDS 101-232

SCAN PDF

FILMING INSTRUCTIONS

Submitter OASouth

No. of CD copies: 2

Headings

Site information

Line 1: [OASouth] County:[Greater London] Parish:[Islington] Site:[Old Street, St Lukes]

Site code[OLR00]

Line 2: Excavators name[A. Boyle]

Line 3:

Classification of material

Tick if present

Index to archive	
Introduction	
A:Final Report	
A:Publication Report	
B:Site Data – Text: Diary/Daybook/Fieldnotes	
B: Site Data – Text: General Summaries	
B: Site Data – Text: Primary Context Records n° 101 → 232	✓
B: Site Data – Text: Synthesised Context Records	
B: Site Data – Text: Survey Reports	
B: Site Data – Text: Catalogue of Drawings	
B: Site Data – Text: Primary Drawings	
B: Site Data – Text: Synthesised Drawings	
C: Finds Data – Text: Primary Finds Data	
C: Finds Data – Text: Synthesised Finds Data	
C: Finds Data – Text: Specialist Reports	
C: Finds Data – Text: Box/Bag List	
D: Catalogue of Photos/Slides/Videos/X--rays	
E: Environmental/Ecofact Data: Primary Records	
E: Environmental/Ecofact Data: Synthesised Records	
E: Environmental/Ecofact Data: Specialist Reports	
F: Documentary	
F: Press and Publicity	
G: Correspondence	
H: Miscellaneous	

SITE CODE: OLROO		CONTEXT CHECKLIST			SITE ST LUKES CHURCH, NAME: ISLINGTON			
Context No	Type	Excavated with Segments	Relationships	Dug	Drawn		Matrix NAMED	Comments
					Section	Plan		
101	STRUC	North churchyard		DS		1		Stone slab & granite block pavement & path edge
102	STRUC					3		ledger
103	STRUC					3		ledger
104	STRUC				1	3		Brick arched vault under vestry.
105	STRUC					3		ledger
106	STRUC					3		Iron/brick support for ledger
107	STRUC					3		2x ledger stones on top of each altar.
108	STRUC					3		Brick base support for ledger (not present)
109	STRUC		Burials 117/118		5	3		Brick vault
110	STRUC		Burials 112-116		6	3		Brick vault
111	STRUC	South churchyard	Burials 604-609		13	4		Brick vault
112	BURIAL	North churchyard	In Vault 110.			3	Y	Burial - lead coffin.
113	BURIAL					3	Y	Burial - lead coffin
114	BURIAL					3		Burial - lead coffin
115	BURIAL					3		Burial - lead coffin
116	BURIAL					3	Y	Burial - lead coffin
117	BURIAL		In Vault 109.			3	Y	Burial - lead coffin
118	BURIAL					3	Y	Burial - lead coffin
119	BURIAL					3		Burial
120	BURIAL					3		Burial
121	STRUC	South churchyard				4		ledger
122	BURIAL	N.C.				3	Y	Burial C.
123	STRUC	S.C.				4		ledger
124	STRUC					4		Brick vault - broken arch, patched with ledger
125	STRUC					4		Brick grave, covered with stone slabs
126	STRUC					4		Brick grave - covered with stone slabs (ledger)
127	STRUC					4		ledger
128	STRUC					4		ledger
129	STRUC					4		ledger
130	STRUC					4		Recumbant Headstone?
131	STRUC					4		ledger
132	STRUC					4		ledger
133	STRUC					4		ledger

BURIALS THIS PAGE = 10

SITE		CONTEXT			SITE			
CODE: OLROO		CHECKLIST			ST LUKES CHURCH			
					NAME: ISLINGTON			
Context No	Type	Excavated with Segments	Relationships	Dug	Drawn		Matrix NAMED	Comments
					Section	Plan		
134	STRUC	S.C.		DS		4		Ledger
135	↓	↓		↓		↓		Reclumbant headstone?
136	↓	↓		↓		↓		ledger
137	↓	↓		↓		↓		↓
138	↓	↓		↓		↓		↓
139	↓	↓		↓		↓		↓
140	↓	↓		↓		↓		↓
141	↓	↓		↓		↓		↓
142	↓	↓		↓		↓		↓
143	↓	↓		↓		↓		↓
144	↓	↓		↓		↓		Brick grave capped by 3 stone slabs.
145	↓	↓		↓		↓		ledger
146	↓	↓		↓		↓		↓
147	↓	↓		↓		↓		↓
148	↓	↓		↓		↓		↓
149	↓	↓		↓		↓		ledger over arched brick grave
150	↓	↓		↓		↓		ledger
151	↓	↓		↓		↓		↓
152	↓	↓		↓		↓		↓
153	↓	↓		↓		↓		↓
154	↓	↓		↓		↓		↓
155	↓	↓		↓		↓		Reclumbant headstone?
156	↓	↓		↓		↓		Reclumbant headstone?
157	↓	↓		↓		↓		stone, ledger supports.
B 158	BURIAL	SC	In vault 149 (uppermost)	↓		6		Burial (wood coffin well preserved)
B 159	BURIAL	N.C.		↓		3		Burial
B 160	BURIAL	N.C.		↓		↓		Burial
- 161	BURIAL	N.C.	In vault 109.	↓		↓		Burial - lead coffin.
B/DNA 162	BURIAL	N.C.	In vault 109	DS		3	7	Burial - lead coffin.
B 163	BURIAL	N.C.		↓		3		Burial - neo natal?
164	STRUC	SC		↓		4		ledger
165	↓	↓		↓		↓		ledger
166	↓	↓		↓		↓		old paved path adjacent to south wall of church

valuation at 1/9/00 = 14 BURIALS

TOTAL BURIALS THIS AGO = 6.

SITE		CONTEXT				SITE ST LUKES CHURCH		
CODE: OLROO		CHECKLIST				NAME: ISLINGTON		
Context No	Type	Excavated with Segments	Relationships	Dug	Drawn		Matrix	Comments
					Section	Plan		
1687	STRUC	SC		DS		4		Iron ledgers.
168	DEPOSIT	NC	overlies (163) & (170)	SML	7	3		Gravel around (S)
169	STRUC		butted/overlain by (169)			3		Stone edge of path 170.
170	DEPOSIT		butts (169)			3		Tarmac/gravel path.
171	DEPOSIT		over (172)		10			GRAVEYARD (N) TOPSOIL
172	STRUC		under (171)					Iron service pipe
173	DEPOSIT		Fo. (172)					Fill of vault 174 cut.
174	STRUC		under 173					Brick vault
175	STRUC		over (176)					Brick base support for ledgers
176	FILL		Fo. (181)					Fill of grave cut
177	DEPOSIT		over (178)		10			GRAVEYARD (N) SOIL
178			cut off 179 under (177)					lense of crushed brick
179			under (178)		10			Demo/const' layer
180			under (179)					DEP UNDER 179!
181	CUT		FB (178) & (174)					Grave cut
182	CUT		FB (173) & (174)					Grave cut
183	DEPOSIT		under (170)					Sandy cement path foundation
184	STRUC		over (168)	✓	✓	3		kerbstones (Dump).
185	BURIAL		with 186	DS		3		Burial
186	BURIAL	✓	with 185	DS		3		Burial
187	Burial	SC	Vault 149 under (158)	SML		6		Burial - in vault 149
188	Burial	SC	under (187)	SML		6		Pb coffin Burial in vault 149
189	Burial	SC	under (188)	SML		6		Burial in vault 149
190	Burial	SC	under (189)	SML		6		Pb coffin in vault 149
191	Burial	SC	under (190)	SML		6		Burial in vault 149
192	Burial	NC	within (208)	SML		3		Burial in vault (208)
193	Burial	NC	within (208)	SML		3	Y	Pb coffin Burial in vault (208)
194	Burial	NC	within (208)	SML		3	Y	Pb coffin Burial in vault (208)
195	Burial	NC	under (218)	SML		3		Burial
196	Burial	NC	with 225	SML		3		Burial
197	SURFACE	NC	over 198	DS	10	8		Tarmac path surface.
198	LAYER		over 199		10			Tarmac/gravel foundation
199	LAYER		over 177					Gravel make-up.

BURIALS THIS SHEET = 12

SITE		CONTEXT			SITE ST LUKES CHURCH			
CODE: OLROO		CHECKLIST						NAME: ISLINGTON
Context No	Type	Excavated with Segments	Relationships	Dug	Drawn		Matrix named?	Comments
					Section	Plan		
200	FILL	NE	Fo. 202	DS	8			Backfill of drain trench.
201	STRUC	NE	Fo. 202			3		Brick drain
202	CUT	NE	FB 200/201					cut for brick drain
203	FILL	NE	Fo. 204					Backfill of const cut for brick step base.
204	CUT	NE	FB 203/207					cut for const of brick step base for non church as whole.
205	LAYER	NE	under 180	↓	10			Pre-church const layer, Golden soil?
206	LAYER	NE	under 205	↓	↓			Pre-church const layer.
207	STRUC	NE	Fo. 204.	↓	↓	3		Brick base for steps
208	STRUC	NE		DS	9	3		Brick vault.
B 209	BURIAL	NC		DS	-	3		Burial.
B 210	BURIAL	NC		SM		3		Burial
B 211	BURIAL	NC		SM		3		Burial
- 212	BURIAL	NC	in vault 110	DS		3		Burial - lead coffin
B 213	BURIAL	NC	in vault 110	DS		3		Burial - lead coffin
B 214	BURIAL	NC		DS		3		Burial.
B 215	BURIAL	NC		DS/SM		3		Burial
B 216	BURIAL		above 218 under 217					lead coffin burial.
B ✓ 217	BURIAL		above 216					Burial
B 218	BURIAL		under 216					Burial
B 219	BURIAL							Burial
B 220	BURIAL		above 221	↓	↓			Burial - truncated?
B 221	BURIAL		under 220.	↓	↓			Burial - child.
B ✓ 222	Burial	NC	under 195	SM		3		Burial
B ✓ 223	Burial	NC	under 195	↓		↓		Burial } in one coffin
B ✓ 224	Burial	NC	under 195	↓		↓		
B 225	Burial	NC	w/ 196, w/ 127	SM		3		Burial
B ✓ 226	Burial	NC	South of 196 + 227	SM		3		Burial
B 227	Burial	NC	under 196 + 225	SM		3		Burial
B 228	Burial	NC	under 209	SM		3		Burial
B ✓ 229	Burial	NC		SM		3		Burial
B 230	Burial	NC		SM		3		Burial
B 231	Burial	NC	w/ 232	SM		3		Burial
B 232	Burial	NC	w/ 231	SM		3		Burial

BURIALS THIS SHEET = 24

SITE OLROD		CONTEXT RECORD		Context No. 101
Trench		Additional Sheets:		Type STRUCTURE
Site sub-div North Graveyard		Context Type: Deposit / Cut / Structure		Check Lists:
Structure No.		Overlain by: N/A		DEPOSIT: 1.compaction 2.colour 3.composition 4.inclusions 5.thickness 6.extent 7.comments 8.method & conditions
Plan No. 1		Abutted by:		
Section No.		Cut by:		CUT: 1.shape in plan 2.base/sides/top profile 3.dimension and depth 4.sketch 5.truncation 6.fill nos 7.other comments
Co-Ordinates		Filled by:		
Level		Same as:		MASONRY: 1.materials 2.size of bricks etc 3.finish of stones 4.coursing/bond 5.form 6.faces 7.bond 8.dimensions as found 9.other comments
Slide No.		Part of:		
Neg No.		Consists of:		
Matrix location		Overlies: graveyard soil?		
		Butts:		
		Cuts:		
		Fill of:		
		Relationships uncertain		

Description (See check lists):
E-W orientated revetment of stone slabs (Yakstone?) running parallel to north facing wall of church.
Slabs - various sizes from 0.3x0.4m → 2x0.95m + 0.06 - 0.11m thick

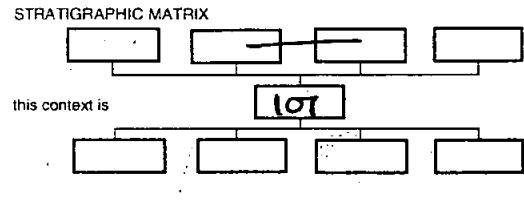

Some poss' reused ledger stones but no inscriptions visible on upper surfaces.
 Set on 0.3m high base of stone slabs ^{(and bricks to west end).} - roughly 3 courses visible. to south bordered by a Yakstone path to north holds back soil of graveyard.

Interpretation/Discussion:
 From each end, an arc of granite blocks, c. 0.25x0.25 square, edge paths converging on northern gateway to graveyard. stone slabs mortared with cement but granite blocks free standing - they respect tomb [2].

Poss the revetment, edging to paths created after burials had raised the ground level slightly in the graveyard - hence the need for a slight revetment to the north of the church wall.

Finds (tick): None Pot Bone Flint Stone Burnt stone Glass Metal
 CBM Wood Leather

△ Small Finds	Recorder DS
◇ Samples	Date 11/7/00
△ Building Materials	Initials

SITE OLR00	CONTEXT RECORD		Context No. 102
	Additional Sheets:		Type ledger
Trench	Context Type: Deposit / Cut / Structure		Check Lists:
Site sub-div <i>Nick Churchyard</i>	Overlain by:	DEPOSIT: 1.compaction 2.colour 3.composition 4.inclusions 5.thickness 6.extent 7.comments 8.method & conditions CUT: 1.shape in plan 2.base/sides/top profile 3.dimension and depth 4.sketch 5.truncation 6.fill nos 7.other comments MASONRY: 1.materials 2.size of bricks etc 3.finish of stones 4.coursing/bond 5.form 6.faces 7.bond 8.dimensions as found 9.other comments	
Structure No.	Abutted by:		
Plan No. 3	Cut by:		
	Filled by:		
Section No.	Same as:		
	Part of:		
Co-Ordinates	Consists of:		
	Overties:		
Level	Butts:		
Slide No.	Cuts:		
Neg No.	Fill of:		
Matrix location	Relationships uncertain		

Description (See check lists):

ledger stone
2.10 x 1.05 x 0.15 m

STRATIGRAPHIC MATRIX

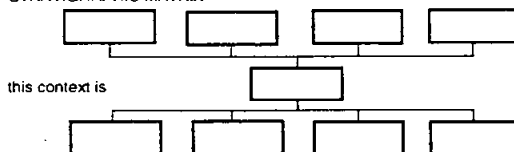

Set on a brick surround/support.

Inscription:
- memory of
- KIRKHAM

Interpretation/Discussion:

- as Broad Cooper
- mswell Street Brewhouse
- he died 21st May 1779
aged 52 years
Also ELIZABETH his wife
who died 18th May 1793
aged 72 years
Also JOHN KIRKHAM ESQ
son of the above
who died 26th FEBRUARY 1833
in his 83rd year.

Finds (tick): None Pot Bone Flint Stone Burnt stone Glass Metal
 CBM Wood Leather

△ Small Finds

Recorder

◇ Samples

Date

△ Building Materials

Initials

SITE <i>OLR00</i>	CONTEXT RECORD	Context No. <i>103</i>
Additional Sheets:		Type <i>ledger</i>
Trench	Context Type: Deposit / Cut / Structure	Check Lists:
Site sub-div <i>North Churchyard -</i>	Overlain by:	DEPOSIT: 1.compaction 2.colour 3.composition 4.inclusions 5.thickness 6.extent 7.comments 8.method & conditions
Structure No.	Abutted by:	
Plan No. <i>3</i>	Cut by:	
Section No.	Filled by:	
Co-Ordinates	Same as:	CUT: 1.shape in plan 2.base/sides/top profile 3.dimension and depth 4.sketch 5.truncation 6.fill nos 7.other comments
Level	Part of:	
Slide No.	Consists of:	MASONRY: 1.materials 2.size of bricks etc 3.finish of stones 4.coursing/bond 5.form 6.faces 7.bond 8.dimensions as found 9.other comments
Neg No.	Overlies:	
Matrix location	Relationships uncertain	
Description (See check lists):		STRATIGRAPHIC MATRIX
<i>Stone ledger.</i> <i>1.85 x 1 x 0.10.</i>		
Interpretation/Discussion:		
<i>Stone slab - ledger / monument supports.</i>		
Finds (tick): None <input type="checkbox"/> Pot <input type="checkbox"/> Bone <input type="checkbox"/> Flint <input type="checkbox"/> Stone <input type="checkbox"/> Burnt stone <input type="checkbox"/> Glass <input type="checkbox"/> Metal <input type="checkbox"/> CBM <input type="checkbox"/> Wood <input type="checkbox"/> Leather <input type="checkbox"/>		
ΔSmall Finds	Recorder	
◇Samples	Date	
ΔBuilding Materials	Initials	

SITE		CONTEXT RECORD		Context No.
OLR00		Additional Sheets:		104
Trench	Context Type: Deposit / Cut / Structure			Check Lists:
Site sub-div North Churchyard	Overlain by:	Directly under Vestry - vestry		DEPOSIT:
Structure No.	Abutted by:	Stonework sits directly on vault		1.compaction 2.colour 3.composition 4.inclusions 5.thickness 6.extent 7.comments 8.method & conditions
Plan No. 3	Cut by:	Walls - all contemporary east?		CUT: 1.shape in plan 2.base/sides/top profile 3.dimension and depth 4.sketch 5.function 6.fill nos 7.other comments
Section No. 1	Same as:			
Co-Ordinates	Part of:			MASONRY: 1.materials 2.size of bricks etc 3.finish of stones 4.coursing/bond 5.form 6.faces 7.bond 8.dimensions as found 9.other comments
Level	Consists of:			
Slide No.	Overlies:			
Neg No.	Butts:	main church wall. to 559?		
Matrix location	Cuts:			
	Fill of:			
	Relationships uncertain			

Description (See check lists):
Brick vault - arch - N-S, internal measures
4.80 x 4.15 m, Bricks red 0.23 x 0.105 x 0.06
m - lime mortar - const' V' similar to main crypt vaults. 2 brick pillars against ~~east~~ wall (internal). Well constructed arch reveals main church wall on south side - vault wall butts church wall - not tied in. - corresponding arch seen in crypt vault so prob' intention was to knock wall thru & join vestry vault with main crypt but this never done. never used?

STRATIGRAPHIC MATRIX

```

graph TD
    104[104] --- 559[559]
    559 --- 558[558]
    559 --- 557[557]
    559 --- 556[556]
    559 --- 555[555]
    559 --- 554[554]
    559 --- 553[553]
    559 --- 552[552]
    559 --- 551[551]
    559 --- 550[550]
    
```

Interpretation/Discussion: Brick Arched Vault under Vestry
 walls/arch - mainly stretcher/header alternate courses.
 blocked entrance (exit!) in West wall with structure 559 outside forming a pillar 'well' for steps but base of vault - chips of brick/mortar - does not appear to have been used. (Blocked entrance overlain by vestry steps so could not have been used after vestry steps put in.
 Vandal hole 40cm square in ceiling & 1993? Penny found but no other damage?

Finds (tick): None Pot Bone Flint Stone Burnt stone Glass Metal
 CBM Wood Leather

Δ Small Finds	NB: when dug out finally on 3/10 - no floor revealed so confirmed - never used as a burial vault - no burials etc.	Recorder JS
◇ Samples		Date 31/10
□ Building Materials		Initials

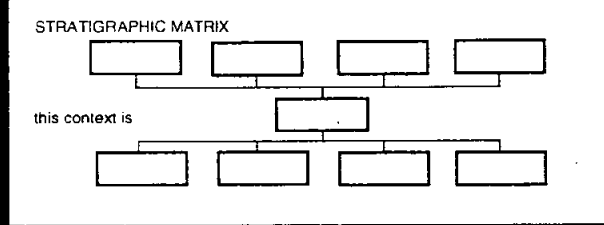
SITE OL200		CONTEXT RECORD		Context No. 105
Trench		Additional Sheets: YES 1		Type Ledger
Site sub-div NC		Context Type: Deposit / Cut / <u>Structure</u>		Check Lists:
Structure No.		Overlain by:		DEPOSIT: 1.compaction 2.colour 3.composition 4.inclusions 5.thickness 6.extent 7.comments 8.method & conditions
Plan No. 3		Abutted by:		
Section No.		Cut by:		CUT: 1.shape in plan 2.base/sides/top profile 3.dimension and depth 4.sketch 5.truncation 6.fill nos 7.other comments
Co-Ordinates		Filled by:		
Level		Same as:		MASONRY: 1.materials 2.size of bricks etc 3.finish of stones 4.coursing/bond 5.form 6.faces 7.bond 8.dimensions as found 9.other comments
Slide No.		Part of:		
Neg No.		Consists of:		
Matrix location		Overlies:		
Description (See check lists): Stone ledger :- 2.05 x 1.05 x 0.12 m		STRATIGRAPHIC MATRIX 		
Inscription:- See add sheet.				
Interpretation/Discussion:				
Finds (tick): None <input type="checkbox"/> Pot <input type="checkbox"/> Bone <input type="checkbox"/> Flint <input type="checkbox"/> Stone <input type="checkbox"/> Burnt stone <input type="checkbox"/> Glass <input type="checkbox"/> Metal <input type="checkbox"/> CBM <input type="checkbox"/> Wood <input type="checkbox"/> Leather <input type="checkbox"/>				
ΔSmall Finds				Recorder JS
◇Samples				Date
ΔBuilding Materials				Initials

SITE

OLROD

CONTEXT RECORD ADDITIONAL SHEET

Context No.

105.

Inscription:- ? WILLSDON

? of this Parish

Also Mrs? ^{Aged -} MARGARET WILLSDON

widow of the above ?

died Sept ~~21~~ 21st 1817

Aged ? 0 years

Also Mr William Willsdon

son of the above Mr Francis Willsdon

died Sept 1st? 1812

Aged 36? years

Also ? Ann Willsdon

died Nov the 7th 1818? Aged 12 years

Also Mrs? Mary Willsdon

Wife? of Francis Willsdon

? Feb? 1819 Aged 44 years

Also ? Francis Willsdon

Died 2? March 1820? Aged 18 years

⊕

son of ⊕ Mary Willsdon ⊕

⊕

? Mary Ann? TWITCHELL

? of m Willsdon

? this Parish

? May 8th 1811

⊕

? ⊕ years. ⊕

⊕

— finished — sp — is —

The prisoner is gone? the christian is dead

The christian is — through —

And gladly rec — — above?

⊕

⊕

⊕

⊕

Oxford Archaeological Unit

SITE <i>OLR 00</i>	CONTEXT RECORD	Context No. <i>106</i>
	Additional Sheets:	Type <i>Support</i>
Trench	Context Type: Deposit / Cut / Structure	Check Lists:
Site sub-div <i>North Churchyard</i>	Overlain by:	DEPOSIT: 1.compaction 2.colour 3.composition 4.inclusions 5.thickness 6.extent 7.comments 8.method & conditions
Structure No.	Abutted by:	
Plan No. <i>3</i>	Cut by:	CUT: 1.shape in plan 2.base/sides/top profile 3.dimension and depth 4.sketch 5.truncation 6.fill nos 7.other comments
	Filled by:	
Section No.	Same as:	MASONRY: 1.materials 2.size of bricks etc 3.finish of stones 4.coursing/bond 5.form 6.faces 7.bond 8.dimensions as found 9.other comments
	Part of:	
Co-Ordinates	Consists of:	
	Overlies:	
Level	Butts:	
Slide No.	Cuts:	
Neg No.	Fill of:	
Matrix location	Relationships uncertain	
Description (See check lists):		
<i>Iron Support :- 1.75 x 0.85 x 0.05m with a course of bricks on it.</i>		STRATIGRAPHIC MATRIX
		this context is
Interpretation/Discussion:		
<i>Iron / Brick support for ledger</i>		
Finds (tick): None <input type="checkbox"/> Pot <input type="checkbox"/> Bone <input type="checkbox"/> Flint <input type="checkbox"/> Stone <input type="checkbox"/> Burnt stone <input type="checkbox"/> Glass <input type="checkbox"/> Metal <input type="checkbox"/> CBM <input type="checkbox"/> Wood <input type="checkbox"/> Leather <input type="checkbox"/>		
ΔSmall Finds	Recorder	
◇Samples	Date	
△Building Materials	Initials	

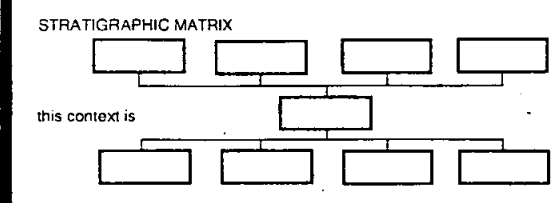
SITE <i>OLR00</i>	CONTEXT RECORD	Context No. <i>107</i>
	Additional Sheets:	Type
Trench	Context Type: Deposit / Cut / Structure	Check Lists:
Site sub-div <i>North Churchyard</i>	Overlain by:	DEPOSIT: 1.compaction 2.colour 3.composition 4.inclusions 5.thickness 6.extent 7.comments 8.method & conditions
Structure No.	Abutted by:	
Plan No. <i>3</i>	Cut by:	CUT: 1.shape in plan 2.base/sides/top profile 3.dimension and depth 4.sketch 5.truncation 6.fill pos 7.other comments
Section No.	Filled by:	
Co-Ordinates	Same as:	MASONRY: 1.materials 2.size of bricks etc 3.finish of stones 4.coursing/bond 5.form 6.faces 7.bond 8.dimensions as found 9.other comments
Level	Part of:	
Slide No.	Consists of:	
Neg No.	Overlies:	
Matrix location	Butts:	
	Cuts:	
	Fill of:	
	Relationships uncertain	
Description (See check lists):		STRATIGRAPHIC MATRIX 
<i>3 stone slabs c. 2 x 1.95 x 0.10m</i> <i>one on top of another - base for monument?</i>		
Interpretation/Discussion:		
<i>3 ledger stones on top of one another.</i>		
Finds (tick): None <input type="checkbox"/> Pot <input type="checkbox"/> Bone <input type="checkbox"/> Flint <input type="checkbox"/> Stone <input type="checkbox"/> Burnt stone <input type="checkbox"/> Glass <input type="checkbox"/> Metal <input type="checkbox"/> CBM <input type="checkbox"/> Wood <input type="checkbox"/> Leather <input type="checkbox"/>		
ΔSmall Finds	Recorder	
◇Samples	Date	
ΔBuilding Materials	Initials	

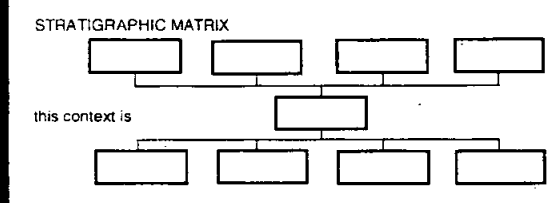
SITE <i>OLR00</i>	CONTEXT RECORD	Context No. <i>108</i>
	Additional Sheets:	Type <i>Brick base</i>
Trench	Context Type: Deposit / Cut / Structure	Check Lists:
Site sub-div <i>North churtyard</i>	Overlain by:	DEPOSIT: 1.compaction 2.colour 3.composition 4.inclusions 5.thickness 6.extent 7.comments 8.method & conditions
Structure No.	Abutted by:	
Plan No. <i>3</i>	Cut by:	CUT: 1.shape in plan 2.base/side/top profile 3.dimension and depth 4.sketch 5.truncation 6.fill nos 7.other comments
Section No.	Filled by:	
Co-Ordinates	Same as:	MASONRY: 1.materials 2.size of bricks etc 3.finish of stones 4.coursing/bond 5.form 6.faces 7.bond 8.dimensions as found 9.other comments
Level	Part of:	
Slide No.	Consists of:	
Neg No.	Overlies:	
Matrix location	Butts:	
	Cuts:	
	Fill of:	
	Relationships uncertain	
Description (See check lists): <i>Brick base</i>		
<i>1.85 x 0.80 x 3 courses thick.</i>		
STRATIGRAPHIC MATRIX 		
Interpretation/Discussion: <i>Brick base support for ledge.</i>		
Finds (tick): None <input type="checkbox"/> Pot <input type="checkbox"/> Bone <input type="checkbox"/> Flint <input type="checkbox"/> Stone <input type="checkbox"/> Burnt stone <input type="checkbox"/> Glass <input type="checkbox"/> Metal <input type="checkbox"/> CBM <input type="checkbox"/> Wood <input type="checkbox"/> Leather <input type="checkbox"/>		
ΔSmall Finds	Recorder	
◇Samples	Date	
△Building Materials	Initials	

SITE OLR00	CONTEXT RECORD	Context No. 109
Additional Sheets:		Type Vault
Trench	Context Type: Deposit / Cut / Structure	Check Lists:
Site sub-div <i>North Churchyard</i>	Overlain by:	DEPOSIT: 1.compaction 2.colour 3.composition 4.inclusions 5.thickness 6.extent 7.comments 8.method & conditions
Structure No.	Abutted by:	
Plan No. 3	Cut by:	CUT: 1.shape in plan 2.base/sides/top profile 3.dimension and depth 4.sketch 5.truncation 6.fill nos 7.other comments
	Filled by: <i>burials 117 + 118 161 + 162</i>	
Section No. 5	Same as: <i>contains burials 117 & 118 161 + 162</i>	MASONRY: 1.materials 2.size of bricks etc 3.finish of stones 4.coursing/bond 5.form 6.faces 7.bond 8.dimensions as found 9.other comments
Co-Ordinates	Consists of: <i>161 162</i>	
Level	Butts:	
Slide No.	Cuts:	
Neg No.	Fill of:	
Matrix location	Relationships uncertain	

Description (See check lists):

Brick vault

Bricks = mid-light pink ^{orange} / pink yellow

220 x 163 x 116 mm

Mortar = hard yellowish grey cement

One brick step ^{comprising} of a row of 10 bricks

Upright stone slab covers the entrance: 655 x 73 x 1200 mm (limestone slab)

Arched roof = 33 courses of brick, wall = 20 ~~low~~ courses high.

STRATIGRAPHIC MATRIX

	161	155	162
this context is			
	109		

Interpretation/Discussion:

Brick Vault containing ^{lead} 2 coffins (named individuals:

Mrs Sarah Brown, Died 30th July 1830, aged 70. and Samuel Roberts, died

9th May 1820, aged 54.

Finds (tick): None Pot Bone Flint Stone Burnt stone Glass Metal

CBM Wood Leather

△Small Finds	Recorder <i>gmc</i>
◇Samples	Date <i>11.9.00</i>
△Building Materials	Initials

SITE

OLR00

CONTEXT RECORD ADDITIONAL SHEET

Context No.

109

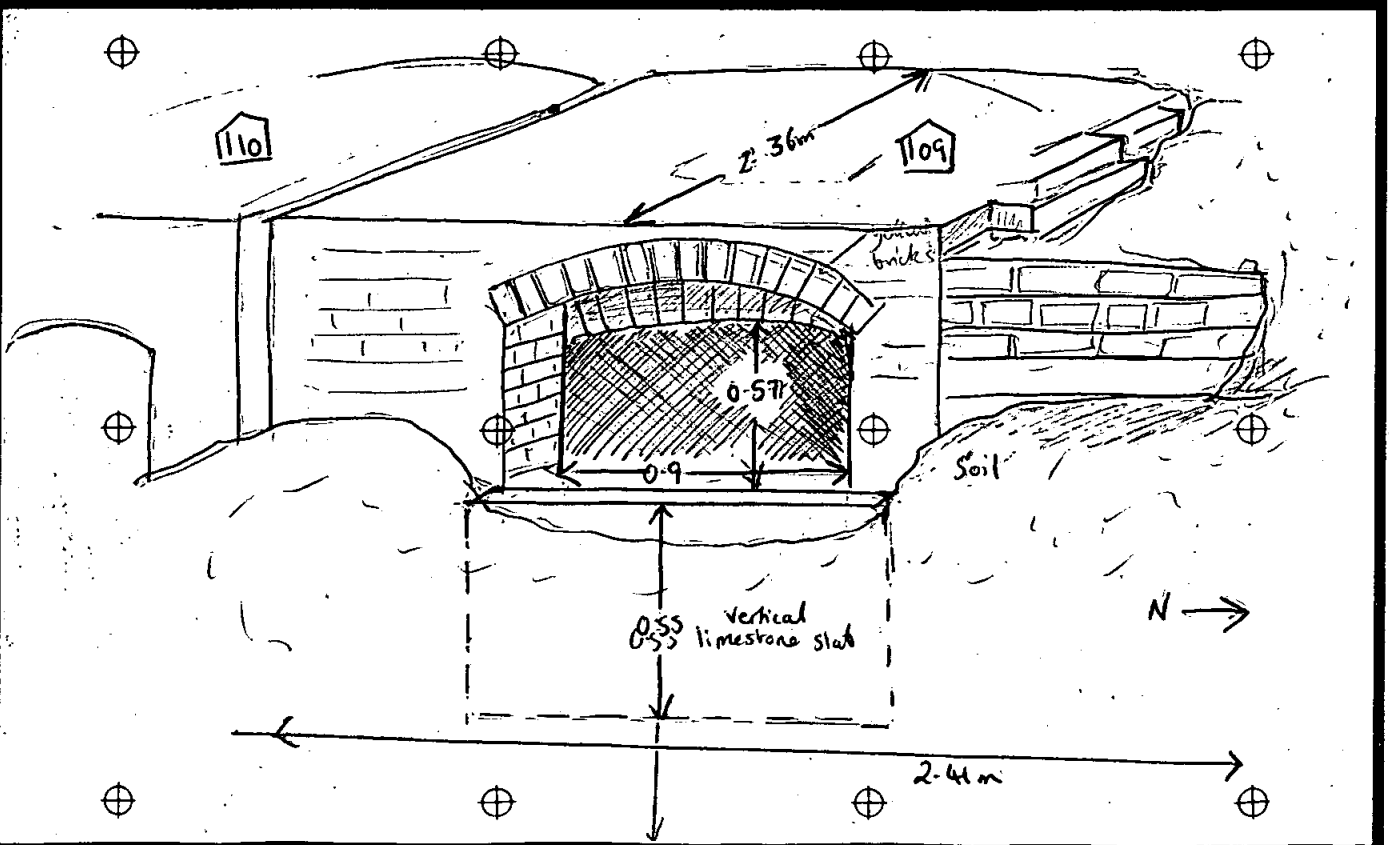
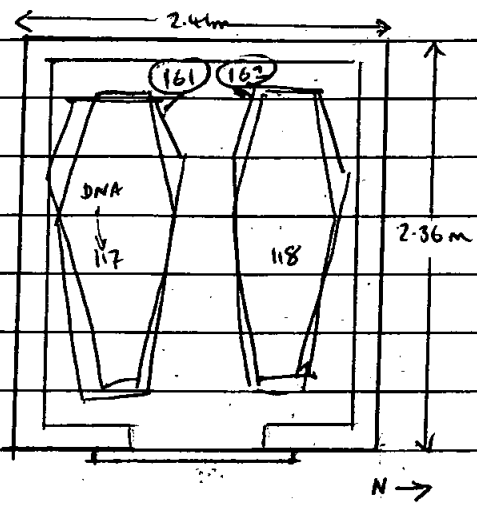
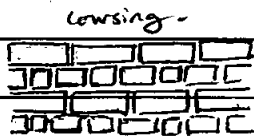
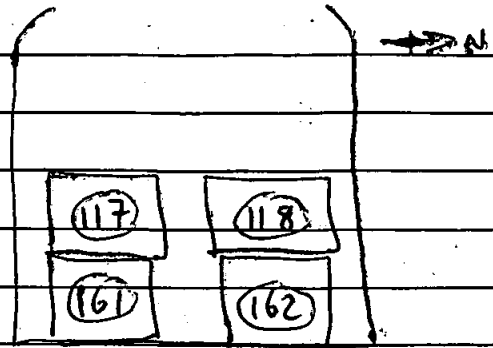

SITE <i>OLR00</i>	CONTEXT RECORD	Context No. <i>110</i>
Trench	Additional Sheets:	Type <i>Vault</i>
Site sub-div <i>North Churchyard</i>	Context Type: <i>Deposit / Cut / Structure</i>	Check Lists:
Structure No.	Overlain by:	DEPOSIT: 1.compaction 2.colour 3.composition 4.inclusions 5.thickness 6.extent 7.comments 8.method & conditions
Plan No. <i>3</i>	Abutted by:	
Section No. <i>6</i>	Cut by:	CUT: 1.shape in plan 2.base/sides/top profile 3.dimension and depth 4.sketch 5.function 6.fill nos 7.other comments
Co-Ordinates	Filled by: <i>Burials 112 to 116 = 112 212 + 213</i>	
Level	Same as:	MASONRY: 1.materials 2.size of bricks etc 3.finish of stones 4.coursing/bond 5.form 6.faces 7.bond 8.dimensions as found 9.other comments
Slide No.	Part of:	
Neg No.	Consists of:	
Matrix location	Overlies:	
	Butts:	
	Cuts:	
	Fill of:	
	Relationships uncertain	

Description (See check lists):

1. Yellowish orange brick 220 x 100 x 60 mm

Hard cement mortar, greyish yellow

Wall = leader courses alternate courses & arch

casely in same stepped arching N→S

Arch = 32 courses - Walls = 24 courses high

3 steps 4 courses high, 8 bricks wide

step height = *0.29m*

← 0.78 →

See add. sheet.

STRATIGRAPHIC MATRIX

	<i>212</i>	<i>115</i>	<i>213</i>
this context is			
	<i>110</i>		

Interpretation/Discussion:

Brick Vault, lying 10cm N of South of Brick vault 109

Containing 7 coffins. lies 5-10cm N of brick grave 3

Finds (tick): None Pot Bone Flint Stone Burnt stone Glass Metal

CBM Wood Leather

△Small Finds	Recorder <i>JUL</i>
◇Samples	Date <i>11.9.00</i>
△Building Materials	Initials

SITE

OLR 00

CONTEXT RECORD ADDITIONAL SHEET

Context No.

110

coursing



Profile through vault

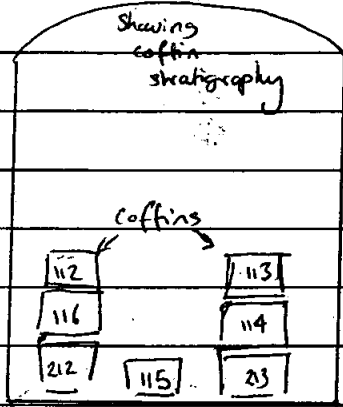

sketch plan

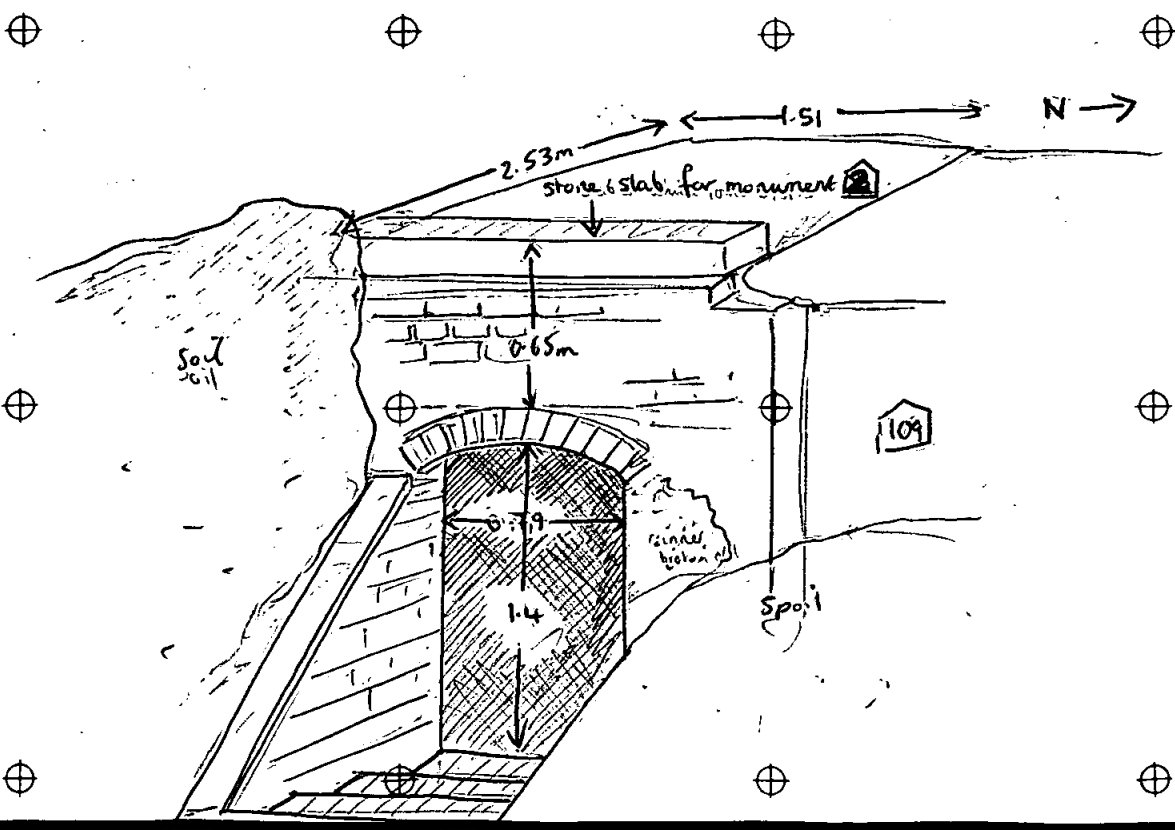
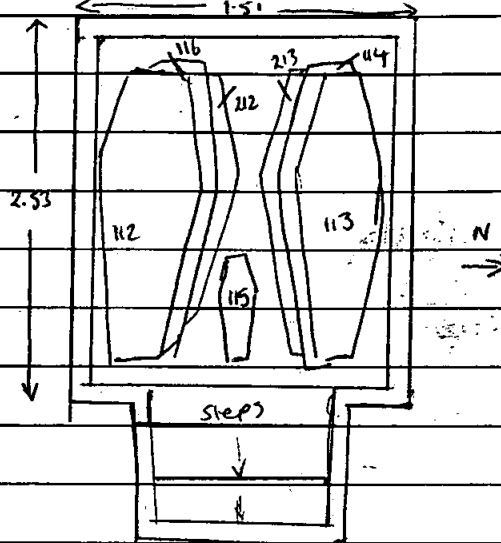

Outer Coffin

Sample Ret.

Site Code

Context

Recording Date 18/10

OLR00

110

Associated Numbers 113-115 (plates found in vault 110 - which contains?)

Condition Dep. Plate x 2 Legible 1 (p.b.)

Inscription
 (a) 1x tin pewter - illegible; rect; no match
 (b) 1x p.b. rect; see following sheet for legend. Some ∞ (340)

Fabric lead ormolou brass tin plated pewter gilt tin
 iron silvered tin enamelled other Sample Ret.

Shape of dep. plate

square rectangle shield tapered lozenge
 cartouche oval other

Upholstery

colour shoddy velvet other Sample Ret.

Construction

butt joint mitred pitched other

Grip plate

Fabric = ormolou brass tin plated pewter gilt tin

iron silvered tin enamelled other Sample Ret.

Grip

Fabric = ormolou brass iron Sample Ret.

Design

swag of rose horseshoe cherub's head plain

other

Grip bolts

Corner bolts Type = gilt brass brass iron

other Sample Ret.

Lid motifs

other

Sample Ret.

Escutcheons

other

Sample Ret.

Upholstery nails

brass gilt brass silvered brass iron enamelled

other Sample Ret.

Fixings

panel nails screws hinges lace Sample Ret.

Timber type

Sample Ret.

Interpretation / Comments

.....

OHROO

~~113~~
cont.

110

plate (b)

" Mrs

Ann Wimpey

Died 25th May

1807

Aged 69 Years"

X NO

NOT 113

- random
plate
placed on
coffin.

~~same as~~

same as (340)

which is sptds (82) w/out shield
but a roccoco shield instead.

SITE <i>02100</i>	CONTEXT RECORD	Context No. <i>111</i>
Trench	Additional Sheets:	Type <i>VAULT</i>
Site sub-div <i>SC</i>	Context Type: <u>Deposit / Cut / Structure</u>	Check Lists:
Structure No.	Overlain by:	DEPOSIT:
Plan No. <i>4/6</i>	Abutted by:	1.compaction 2.colour 3.composition 4.inclusions 5.thickness 6.extent 7.comments 8.method & conditions
Section No. <i>13</i>	Cut by:	CUT:
Co-Ordinates	Filled by:	1.shape in plan 2.base/sides/top profile 3.dimension and depth 4.sketch 5.truncation 6.fill nos 7.other comments
Level	Same as:	MASONRY:
Slide No.	Part of:	1.materials 2.size of bricks etc 3.finish of stones 4.coursing/bond 5.form 6.faces 7.bond 8.dimensions as found 9.other comments
Neg No.	Overlies:	
Matrix location	Butts:	
	Cuts:	
	Fill of:	
	Relationships uncertain	

Description (See check lists):
ROUGH RED BRICKS 225 x 95 x 65mm
 ALTERNATE HEADER / STRETCHER COURSES.
 AN EAST-WEST ALIGNED VAULT/TOMB
 1.42m (N-S) x 2.65 (E-W) - INTERNAL
 ≤ 2.65m HIGH (INTERNAL - FLOOR - CEILING)
 ARCH (N-S)
 (S.13-SEE) - STEP EDGES OF WOOD -
 DECAYED

STRATIGRAPHIC MATRIX

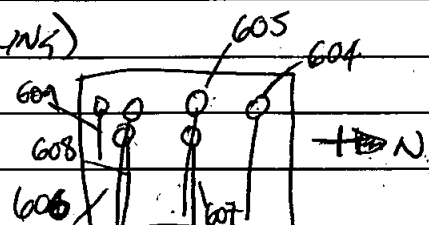
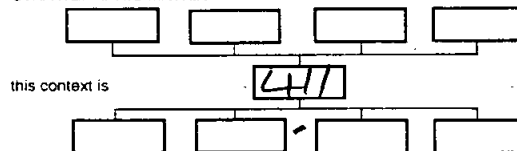

Interpretation/Discussion:

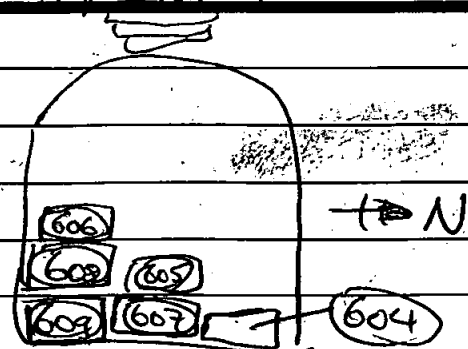
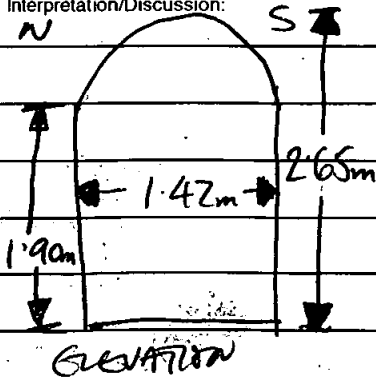

Finds (tick): None Pot Bone Flint Stone Burnt stone Glass Metal
 CBM Wood Leather

Δ Small Finds

◇ Samples

△ Building Materials

Recorder *PJ*
 Date *11/10/00*
 Initials

db.

SITE	COFFIN RECORD SHEET	CONTEXT NO.
OLR00		112
Trench:	Additional sheets: YES x2	Treatment: largely intact no bones collected.
Site sub-div: North Churchyard	Grave fills	
Plan no: 3	Grave cut:	Findings None
Section no:	Skeleton:	Breastplate Grip
Co-ordinates:	Matrix location: Vault 110 over 116	Hinge Bracket
Levels	Preservation:	Fixing nails Shroud pins
Slide No.	Neg No:	Fabric Other finds

Description pb coffin 1.90 x 0.55 x 0.40m, outer wood had material to studs.

Discussion LEAD COFFIN BURIAL IN VAULT 110.

Shape, dimensions and distinguishing characteristics

LID

Nameplate: - Edwin ^HMills,
Esgie
Died 24 Sept
1844
Aged 58 years

Fittings generally badly corroded:-

HEAD

lid rusty:- lower → 

BASE

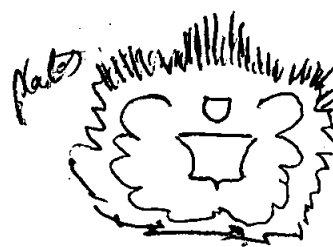
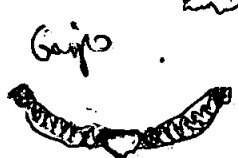

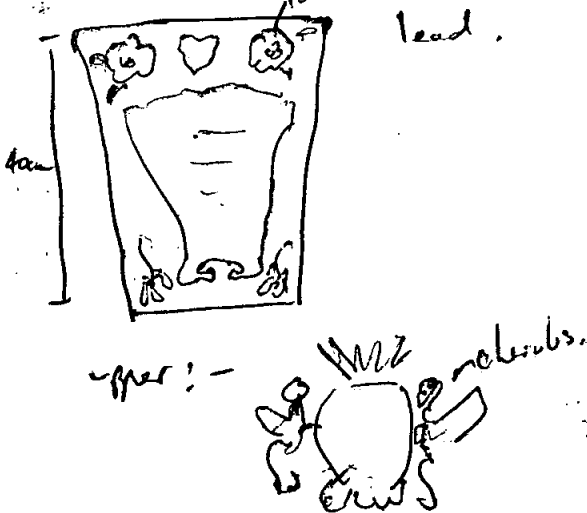
Recorder:	Date:	Initials:
-----------	-------	-----------

Site Code

Context

Outer Coffin

Sample Ret.

02000

112

Recording Date 19/10

Associated Numbers

Condition 4

Dep. Plate

Legible

Inscription "Edwin ~~Wills~~ Esq^{re} / Died 24th Sept / 1844 / Aged 53 Yrs"
 - Has makers marks: bottom RHS - "J PRICE & CO" Film 27(14-16)
 bottom LHS - "LONDON"
 bottom LHS - hallmark.

Fabric lead ormolou brass tin plated pewter gilt tin
 iron silvered tin enamelled other Sample Ret.

Shape of dep. plate

square rectangle shield tapered lozenge
 cartouche oval other

Upholstery

colour shoddy velvet other Sample Ret.

Construction butt joint mitred pitched other

Grip plate Fabric = ormolou brass tin plated pewter gilt tin
 iron silvered tin enamelled other Sample Ret.
from field records grip plate is a (14)

Grip Fabric = ormolou brass iron Sample Ret.
from records grip is a (6)

Design swag of rose horseshoe cherub's head plain
 other

Grip bolts **Corner bolts** Type = gilt brass brass iron

other Sample Ret.

Lid motifs other *tin pewter wren - same as 600. - upper* Sample Ret.
tin pewter angels - (6) - lower.

Escutcheons other Sample Ret.

Upholstery nails brass gilt brass silvered brass iron enamelled

other Sample Ret.

Fixings panel nails screws hinges lace Sample Ret.

Timber type Sample Ret.

Interpretation / Comments

.....

db

SITE OLR 00	COFFIN RECORD SHEET	CONTEXT NO. 113
Trench:	Additional sheets: 111/112/113	Treatment: DNA Sampled. BONES COLLECTED
Site sub-div: North Churchyard	Grave fills	
Plan no: 3	Grave cut:	Finds None
Section no:	Skeleton:	Breastplate ✓ on pb. Grip
Co-ordinates:	Matrix location: Vault <u>110</u> over <u>114</u>	Hinge Bracket
Levels	Preservation:	Fixing nails Shroud pins
Slide No.	Neg No:	Fabric Other finds
<p>Description BURIAL IN LEAD COFFIN IN VAULT <u>110</u></p> <p>pb coffin :- 1.70 x 0.45 x 0.35m with pb plate → Mary Bailey Died 12 Dec 1820 Aged 76 years</p> <p>Discussion 113 →</p>		
<p>Shape, dimensions and distinguishing characteristics</p> <p>LID NB:- also 2 unrelated plates placed on top of this coffin.</p> <p>1) Small lead (0.15m) Mast' James ? Holiday? Died - Dec 1835 Aged 2 months</p> <p>2) Ann W? Peris Died 23 May? 1807 Aged 69 years.</p> <p>BASE - part off lower coffin in vault?</p>		
Recorder:	Date:	Initials:

db.

SITE <i>OLR00</i>		COFFIN RECORD SHEET	CONTEXT NO. <i>114</i>
Trench: <i>110</i>	Additional sheets: <i>YES x 1</i>	Treatment: <i>BONES COLLECTED</i>	
Site sub-div: <i>North Churchyard</i>	Grave fills		
Plan no: <i>3</i>	Grave cut:	Finds None	
Section no:	Skeleton:	Breastplate Grip	
Co-ordinates:	Matrix location: <i>vault 110</i> <i>over 213 under 113</i>	Hinge Bracket	
Levels	Preservation:	Fixing nails Shroud pins	
Slide No.	Neg No:	Fabric Other finds	
Description <i>Mb coffin 1.65 x 0.45 x 0.40</i>			
Discussion <i>BURIAL IN LEAD COFFIN IN VAULT 110</i>			
Shape, dimensions and distinguishing characteristics			
LID			
HEAD			
BASE			
Recorder:	Date:	Initials:	

Coffin Recording Sheet

Site Code

Context

OR200

114

Outer Coffin

Sample Ret.

Recording Date 18/10

Associated Numbers

Condition 1

Dep. Plate

Legible ish

Inscription "Mr / John Bailey / Died 7th October / 1820 / in ~~the~~ ^{the} 83 Year / of his life /"

Fabric lead ormolou brass tin plated pewter gilt tin
iron silvered tin enamelled other Sample Ret.

Shape of dep. plate

square rectangle plain. shield tapered lozenge
cartouche oval other

Upholstery

colour shoddy velvet other Sample Ret.

Construction

butt joint mitred pitched other

Grip plate Fabric = ormolou brass tin plated pewter gilt tin
iron silvered tin enamelled other Sample Ret.

Grip Fabric = ormolou brass iron 2 Sample Ret.

Design swag of rose horseshoe cherub's head plain
other (A)'s spfeds.

Grip bolts Corner bolts Type = gilt brass brass iron
other Sample Ret.

Lid motifs other Sample Ret.

Escutcheons other Sample Ret.

Upholstery ~~nails~~ ^{studs} brass gilt brass silvered brass iron enamelled
other 1x 000 / 1x 00 / 1x 0 = 6 studs intok! Sample Ret.

Fixings panel nails screws hinges lace Sample Ret.

Timber type Sample Ret.

Interpretation / Comments

.....

.....

SITE 0LR00	COFFIN RECORD SHEET	CONTEXT NO. 115
Trench:	Additional sheets:	Treatment: ?
Site sub-div: North Churchyard	Grave fills	
Plan no: 3	Grave cut:	Finds None
Section no:	Skeleton:	Breastplate Grip
Co-ordinates:	Matrix location: Vault 110 on base between 212 213	Hinge Bracket
Levels	Preservation:	Fixing nails Shroud pins
Slide No.	Neg No:	Fabric Other finds
<p>Description</p> <p style="text-align: center;">Pb - child coffin.</p> <p>Discussion BURIAL, LEAD COFFIN IN VAULT 110</p>		
<p>Shape, dimensions and distinguishing characteristics</p> <p>LID</p> <p>HEAD</p> <p>BASE</p>		
Recorder:	Date:	Initials:

db.

SITE OLR 00	COFFIN RECORD SHEET	CONTEXT NO. 116
Trench:	Additional sheets: YES x 2	Treatment:
Site sub-div: North Churchyard	Grave fills	
Plan no: 3	Grave cut:	Finds None
Section no:	Skeleton:	Breastplate Grip
Co-ordinates:	Matrix location: vault 110 under 112 over 212	Hinge Bracket
Levels	Preservation:	Fixing nails Shroud pins
Slide No.	Neg No:	Fabric Other finds
<p>Description wood — studs (material), 1rd nails hitting decayed. pb coffin → 1.85 x 0.60 x 0.45, plate fixed.</p> <p>Discussion BURIAL - LEAD COFFIN IN VAULT 110.</p>		
<p>Shape, dimensions and distinguishing characteristics</p> <p>LID</p> <p>HEAD</p> <p>BASE</p>		
Recorder:	Date:	Initials:

Site Code

Context

OH200

116

Outer Coffin

Sample Ret.

Recording Date 10/10

Associated Numbers

Condition

Dep. Plate

Legible

Inscription

X 2

Fabric lead *both* ormolou brass tin plated pewter gilt tin
 iron silvered tin enamelled other Sample Ret.

Shape of dep. plate

square rectangle *both* shield tapered lozenge
 cartouche oval other

Upholstery

colour shoddy velvet other Sample Ret.

Construction

butt joint mitred pitched other

Grip plate Fabric = ormolou brass tin plated pewter gilt tin
 iron silvered tin enamelled other Sample Ret.

Grip Fabric = ormolou brass iron Sample Ret.

Design swag of rose horseshoe cherub's head plain
 other

Grip bolts **Corner bolts** Type = gilt brass brass iron
 other Sample Ret.

Lid motifs other Sample Ret.

Escutcheons other Sample Ret.

Upholstery nails brass gilt brass silvered brass iron enamelled
 other Sample Ret.

Fixings panel nails screws hinges lace Sample Ret.

Timber type Sample Ret.

Interpretation / Comments

.....
.....

plate (a)
(from p.b. lid)

" Mrs
Ann Hills
Died 13th Sept^r
1835
Aged 58 Years

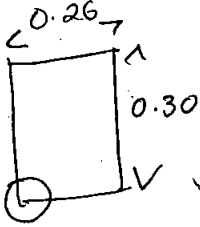

plate (b)
(from outer w. lid)

" Mrs
Ann Hills
Died 13th Sept^r
1835
Aged 58 Years

(Block polished.)

Sptfds

(84) = tapered:
but plate (a) is
Rectangular but
identical.

db.

SITE OLR00	COFFIN RECORD SHEET	CONTEXT NO. 117
Trench:	Additional sheets: YES x 2.	Treatment: DNA sampled BONES COLLECTED
Site sub-div: North churchyard	Grave fills	
Plan no: 3	Grave cut:	Finds None
Section no:	Skeleton:	Breastplate ✓ Grip ✓ unidentified?
Co-ordinates:	Matrix location: N.C. vault 109 over coffin 161.	Hinge Bracket
Levels	Preservation:	Fixing nails Shroud pins
Slide No.	Neg No:	Fabric Other finds
Description 2 lid motifs v' decayed. Pb → 1.80 x 0.50 x 0.35 m		
Discussion BURIAL-LEAD COFFIN IN VAULT 109 Samuel Roberts, Died 9 May 1820. Aged 54.		
Shape, dimensions and distinguishing characteristics LID HEAD BASE		
Recorder:	Date:	Initials:

Site Code

Context

0200

117

Outer Coffin

Sample Ret.

Recording Date 25/10

Associated Numbers

Condition 4

Dep. Plate

Legible

Inscription "Mr Samuel Roberts / Died 9th May / 1820 :- / Aged 54 years"

w/ 362 inner border & plain outer.

Fabric lead ormolou brass tin plated pewter gilt tin
 iron silvered tin enamelled other Sample Ret.

Shape of dep. plate

square rectangle shield tapered lozenge
 cartouche oval other

Upholstery

+ 'punched' locs combie from lining.

colour shoddy velvet other *Beize* Sample Ret.

Construction

butt joint mitred pitched other

Grip plate

Fabric = ormolou brass tin plated pewter gilt tin
 iron silvered tin enamelled other Sample Ret.

Grip

Fabric = ormolou brass iron *x 4* Sample Ret.
 Design swag of rose horseshoe cherub's head *small* *0.11* plain
0.05

Grip bolts

Corner bolts Type = gilt brass brass iron
 other Sample Ret.

Lid motifs

? other *dec fe. plate. - part of lid motif? - unid* Sample Ret.

Escutcheons

other *fe. 4 x 3 block enamelled x* Sample Ret.

Upholstery nails

brass gilt brass silvered brass iron enamelled
 other *dbl row* Sample Ret.

Fixings

panel nails screws hinges lace Sample Ret.

Timber type

Sample Ret.

Interpretation / Comments

.....

02200

117

cm't.

foot/head panel.

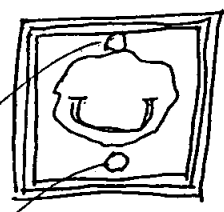

Fe. button (A) black enameled.

grip plate (6)

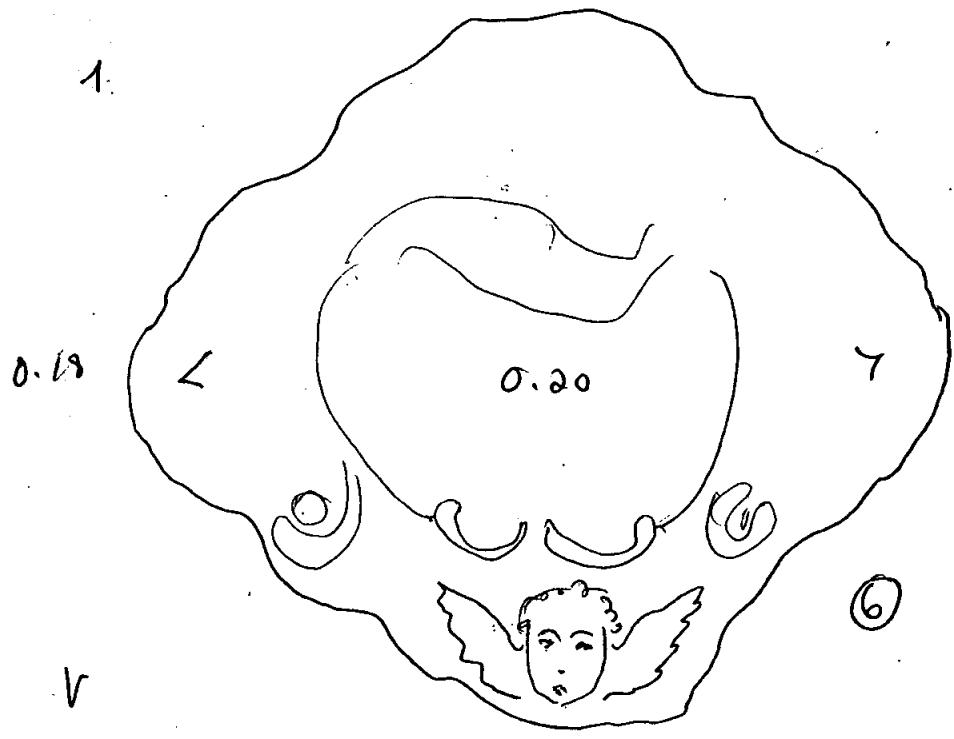

db.

SITE		COFFIN RECORD SHEET		CONTEXT NO.	
OLR 00				118	
Trench:		Additional sheets: YES X1		Treatment: DNA SAMPLED BONES COLLECTED	
Site sub-div: North churchyard		Grave fills			
Plan no: 3		Grave cut:		Finds None	
Section no:		Skeleton:		Breastplate Grip	
Co-ordinates:		Matrix location: Vault 1091 over 162		Hinge Bracket	
Levels		Preservation:		Fixing nails Shroud pins	
Slide No.		Neg No:		Fabric Other finds	
Description outer wood with studs, 2 lid motifs - unidentified? lead coffin → 1.80 x 0.60 x 0.40 m					
Discussion BURIAL-LEAD COFFIN IN VAULT 1091 plate:- Sarah Brown, died 30 July 1830. In her 70th year					
Shape, dimensions and distinguishing characteristics					
LID					
HEAD					
BASE					
Recorder:		Date:		Initials:	

Coffin Recording Sheet

Site Code

Context

02200

118

Outer Coffin

Sample Ret.

Recording Date 11/10

Associated Numbers ~~1118~~

Condition

Dep. Plate

Legible

Inscription *Mrs Sarah Brown Died 30th July 1830 / In her 70th Yr*

Fabric lead ormolou brass tin plated pewter gilt tin
 iron silvered tin enamelled other Sample Ret.

Block polished Spttds (82)

Shape of dep. plate

square rectangle shield tapered lozenge
 cartouche oval other ~~some of the (82) are oval~~

Upholstery

colour shoddy velvet other Sample Ret.

Construction

butt joint mitred pitched other

Grip plate Fabric = ormolou brass tin plated pewter gilt tin
 iron silvered tin enamelled other Sample Ret.

Grip Fabric = ormolou brass iron Sample Ret.

Design swag of rose horseshoe cherub's head plain
 other

Grip bolts Corner bolts Type = gilt brass brass iron
 other Sample Ret.

Lid motifs other Sample Ret.

Escutcheons other Sample Ret.

Upholstery nails brass gilt brass silvered brass iron enamelled
 other Sample Ret.

Fixings panel nails screws hinges lace Sample Ret.

Timber type Sample Ret.

Interpretation / Comments

.....

db.

SITE OLR00	COFFIN RECORD SHEET	CONTEXT NO. 119
Trench:	Additional sheets:	Treatment:
Site sub-div:	Grave fills	
Plan no:	Grave cut:	Finds None
Section no:	Skeleton:	Breastplate Grip
Co-ordinates:	Matrix location:	Hinge Bracket
Levels	Preservation:	Fixing nails Shroud pins
Slide No.	Neg No:	Fabric Other finds :
Description		
Discussion		
Shape, dimensions and distinguishing characteristics		
LID		
HEAD		
BASE		
Recorder:	Date:	Initials:

Coffin Recording Sheet

Site Code

Context

02100

119

Outer Coffin

Sample Ret.

Recording Date 10/10

Associated Numbers

Condition

Dep. Plate

Legible

Inscription

Fabric lead ormolou brass tin plated pewter gilt tin
 iron silvered tin enamelled other Sample Ret.

Shape of dep. plate

square rectangle shield tapered lozenge
 cartouche oval other

Upholstery

colour shoddy velvet other Sample Ret.

Construction

butt joint mitred pitched other

Grip plate Fabric = ormolou brass tin plated pewter gilt tin
 iron silvered tin enamelled other Sample Ret.

Grip Fabric = ormolou brass iron Sample Ret.

Design swag of rose horseshoe cherub's head plain
 other

Grip bolts **Corner bolts** **Type =** gilt brass brass iron
 other Sample Ret.

Lid motifs other Sample Ret.

Escutcheons other Sample Ret.

Upholstery studs brass gilt brass silvered brass iron ⁵ _{pieces}
 other 1x 0000 1x 000 1x 0000 1x 00 1x 0 total of 15 studs from subadult coffin. Sample Ret.

Fixings panel nails screws hinges lace Sample Ret.

Timber type Sample Ret.

Interpretation / Comments

.....

SITE <i>OLR 00</i>	COFFIN RECORD SHEET	CONTEXT NO. <i>120</i>
Trench:	Additional sheets:	Treatment: <i>BONES COLLECTED</i>
Site sub-div: <i>North Chuddey rd.</i>	Grave fills	
Plan no: <i>3</i>	Grave cut:	Finds None
Section no:	Skeleton:	Breastplate Grip
Co-ordinates:	Matrix location:	Hinge Bracket
Levels	Preservation:	Fixing nails Shroud pins
Slide No.	Neg No:	Fabric Other finds :
<p>Description</p> <p>Discussion <i>BURIAL</i></p>		
<p>Shape, dimensions and distinguishing characteristics</p> <p>LID</p> <p>HEAD</p> <p>BASE</p>		
Recorder:	Date:	Initials:

Oxford Archaeological Unit

SITE <i>OLR00</i>		CONTEXT RECORD		Context No. <i>121</i>
Trench		Additional Sheets:		Type <i>Ledger</i>
Context Type: <i>Deposit / Cut / Structure</i>		Check Lists:		
Site sub-div <i>South ch. w. wall</i>	Overlain by:	DEPOSIT:		
Structure No.	Abutted by:	1.compaction 2.colour 3.composition 4.inclusions 5.thickness 6.extent 7.comments 8.method & conditions		
Plan No. <i>A</i>	Cut by:	CUT:		
	Filled by:	1.shape in plan 2.base/sides/top profile 3.dimension and depth 4.sketch 5.truncation 6.fill nos 7.other comments		
Section No.	Same as:	MASONRY:		
	Part of:	1.materials 2.size of bricks etc 3.finish of stones 4.coursing/bond 5.form 6.faces 7.bond 8.dimensions as found 9.other comments		
Co-Ordinates <i>(From ch. wall SE corner)</i> <i>13w</i> <i>2.5s</i>	Consists of:			
	Overlies:			
Level	Butts:			
Slide No.	Cuts:			
Neg No.	Fill of:			
Matrix location	Relationships uncertain			
Description (See check lists): <i>Inscription:</i> <i>In Memory of</i> <i>Mr William Clark</i> <i>of Islington</i> <i>who died 13th March 1872 (2-)</i> <i>Aged 70 years</i>		<p>STRATIGRAPHIC MATRIX</p> <p>this context is</p>		
		<i>Also Mrs Mary Clark</i> <i>wife of the above</i> <i>- Died 29th May 1872</i> <i>Aged 73 years.</i>		
Interpretation/Discussion: <i>Stone Ledger dimensions 1.8 x 0.83m</i>				
Finds (tick): None <input type="checkbox"/> Pot <input type="checkbox"/> Bone <input type="checkbox"/> Flint <input type="checkbox"/> Stone <input type="checkbox"/> Burnt stone <input type="checkbox"/> Glass <input type="checkbox"/> Metal <input type="checkbox"/> CBM <input type="checkbox"/> Wood <input type="checkbox"/> Leather <input type="checkbox"/>				
△Small Finds			Recorder <i>OS</i>	
◇Samples			Date <i>29.8.00</i>	
△Building Materials			Initials	

db.

SITE 0LR00	COFFIN RECORD SHEET	CONTEXT NO. 122
Trench:	Additional sheets: 4E3x1	Treatment: Bones collected, DNA Sampled
Site sub-div: North Churchyard	Grave fills	
Plan no: 3	Grave cut:	Finds None
Section no:	Skeleton:	Breastplate Grip
Co-ordinates:	Matrix location:	Hinge Bracket
Levels	Preservation:	Fixing nails Shroud pins
Slide No.	Neg No:	Fabric Other finds :
Description		
Discussion		
Shape, dimensions and distinguishing characteristics		
LID		
HEAD		
BASE		
Recorder:	Date:	Initials:

Outer Coffin

Sample Ret.

Site Code

Context

04200

122

Recording Date 19/10

Associated Numbers

Condition 2

Dep. Plate

Legible ish.

Inscription "Mrs/Ann Webb/Died 19th Feb^{ry}/1850/in her 75th Year"

Fabric lead ormolou brass tin plated pewter gilt tin
 iron silvered tin enamelled other Sample Ret.

Shape of dep. plate

square rectangle shield tapered lozenge
 cartouche oval other = 2 degraded J. PRICE it. 122.

Upholstery

colour shoddy velvet other Sample Ret.

Construction

butt joint mitred pitched other

Grip plate

Fabric = ormolou brass tin plated pewter gilt tin
 iron silvered tin enamelled other Sample Ret.
frag on lev of grip - unid.

Grip

Fabric = ormolou brass iron x 2 Sample Ret.

Design

swag of rose horseshoe cherub's head (4)'s plain

other

Grip bolts

Corner bolts Type = gilt brass brass iron

other Sample Ret.

Lid motifs

other Sample Ret.

Escutcheons

other Sample Ret.

Upholstery

studs
 nails brass gilt brass silvered brass iron x 2 pieces enamelled
 other Sample Ret.

Fixings

panel nails screws hinges lace Sample Ret.

Timber type

Sample Ret.

Interpretation / Comments

.....

Oxford Archaeological Unit

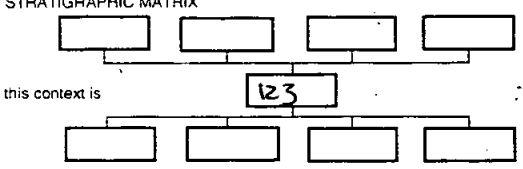
SITE <i>OLR 00</i>	CONTEXT RECORD		Context No. 123
Additional Sheets:		Type <i>Ledger</i>	
Trench	Context Type: <i>Deposit / Cut / Structure</i>		Check Lists:
Site sub-div <i>South churchyard</i>	Overlain by:	DEPOSIT: 1.compaction 2.colour 3.composition 4.inclusions 5.thickness 6.extent 7.comments 8.method & conditions	
Structure No.	Abutted by:		
Plan No. 4	Cut by:		
Filled by:			
Section No.	Same as:	CUT: 1.shape in plan 2.base/sides/top profile 3.dimension and depth 4.sketch 5.truncation 6.fill pos 7.other comments	
Part of:			
Co-Ordinates <i>from SW corner of church.</i> 9W, 9S.	Consists of:		
Overlies:		MASONRY: 1.materials 2.size of bricks etc 3.finish of stones 4.coursing/bond 5.form 6.faces 7.bond 8.dimensions as found 9.other comments	
Level	Butts:		
Slide No.	Cuts:		
Neg No.	Fill of:		
Matrix location	Relationships uncertain		
Description (See check lists): <i>Stone ledger</i> <i>1.8 x 0.9 x 0.08m, bevelled edge.</i>		STRATIGRAPHIC MATRIX 	
(Empty rows for additional description or notes)			
Interpretation/Discussion: <i>Ledger</i>			
Finds (tick): None <input type="checkbox"/> Pot <input type="checkbox"/> Bone <input type="checkbox"/> Flint <input type="checkbox"/> Stone <input type="checkbox"/> Burnt stone <input type="checkbox"/> Glass <input type="checkbox"/> Metal <input type="checkbox"/> CBM <input type="checkbox"/> Wood <input type="checkbox"/> Leather <input type="checkbox"/>			
ΔSmall Finds		Recorder <i>DS</i>	
◇Samples		Date <i>29 8 00</i>	
◊Building Materials		Initials	

SITE <i>OLR 00</i>		CONTEXT RECORD		Context No. <i>124</i>
Trench		Additional Sheets:		Type <i>Vault</i>
Site sub-div <i>Small chertyard</i>		Context Type: <i>Deposit / Cut / Structure</i>		Check Lists:
Structure No.		Overlain by:		DEPOSIT: 1.compaction 2.colour 3.composition 4.inclusions 5.thickness 6.extent 7.comments 8.method & conditions
Plan No. <i>4</i>		Abuted by:		
Section No.		Cut by:		CUT: 1.shape in plan 2.base/sides/top profile 3.dimension and depth 4.sketch 5.truncation 6.fill nos 7.other comments
Co-Ordinates		Filled by:		
Level		Same as:		MASONRY: 1.materials 2.size of bricks etc 3.finish of stones 4.coursing/bond 5.form 6.faces 7.bond 8.dimensions as found 9.other comments
Slide No.		Part of:		
Neg No.		Consists of:		
Matrix location		Overlies:		
		Butts:		
		Cuts:		
		Fill of:		
		Relationships uncertain		

Description (See check lists):

*Dimensions: 2.7 x 2.0 m Walls 0.23m thick,
arched roof N-S, broken, butt filled.
Ledge = 1.75 x 0.9 x 0.1 m covers bench.*

STRATIGRAPHIC MATRIX

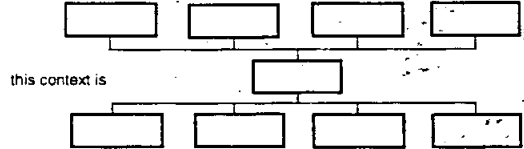

*CONTAINS BURIALS 868 & 869 WITHIN Pb LINEN
COFFINS. Vault collapse = poor preservation of Pb coffins
(V. BADLY CAUSHED). BRICK FLOORED VAULT - SINGLE
COURSE BASE, 1 1/2 COURSE WIDE WALLS - LIGHT POWDERY MORTAR*

Interpretation/Discussion:

Brick vault with a broken arch patched with a ledge.

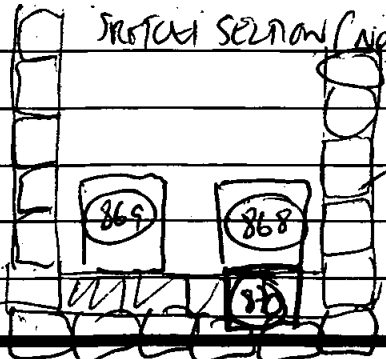

STRUCTURAL SECTION (NOT TO SCALE)

VAULT WALLS

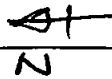

*NOTE: NATURAL SILTY CLAYERS
PRESENT BENEATH VAULT.*

Finds (tick): None Pot Bone Flint Stone Burnt stone Glass Metal
CBM Wood Leather

△ Small Finds

Recorder *DS*

◇ Samples

Date *29.8.00*

○ Building Materials

Initials

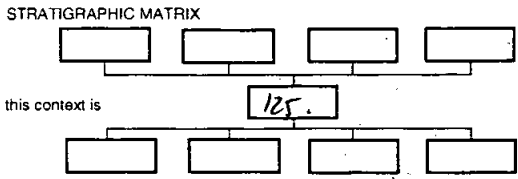
SITE <i>0CR00</i>	CONTEXT RECORD	Context No. <i>125</i>
	Additional Sheets:	Type <i>Brick Grave</i>
Trench	Context Type: <i>Deposit / Cut / Structure</i>	Check Lists:
Site sub-div <i>South churchyard</i>	Overlain by:	DEPOSIT: <ul style="list-style-type: none"> 1.compaction 2.colour 3.composition 4.inclusions 5.thickness 6.extent 7.comments 8.method & conditions
Structure No.	Abutted by:	
Plan No. <i>4</i>	Cut by:	CUT: <ul style="list-style-type: none"> 1.shape in plan 2.base/sides/top profile 3.dimension and depth 4.sketch 5.truncation 6.fill nos 7.other comments
Section No.	Filled by:	
Co-Ordinates <i>of chur. - from SW corner.</i> <i>9w 5g</i>	Same as:	MASONRY: <ul style="list-style-type: none"> 1.materials 2.size of bricks etc 3.finish of stones 4.coursing/bond 5.form 6.faces 7.bond 8.dimensions as found 9.other comments
Level	Part of:	
Slide No.	Consists of:	
Neg No.	Overlies:	
Matrix location	Butts:	
	Cuts:	
	Fill of:	
	Relationships uncertain	
Description (See check lists): <i>Dimensions of brick grave: 2.5 x 1.25 x 0.23m</i> <i>3 stone slabs cover the top.</i>		STRATIGRAPHIC MATRIX 
Interpretation/Discussion: <i>Brick Grave capped with stone slabs</i>		
Finds (tick): None <input type="checkbox"/> Pot <input type="checkbox"/> Bone <input type="checkbox"/> Flint <input type="checkbox"/> Stone <input type="checkbox"/> Burnt stone <input type="checkbox"/> Glass <input type="checkbox"/> Metal <input type="checkbox"/> CBM <input type="checkbox"/> Wood <input type="checkbox"/> Leather <input type="checkbox"/>		
ΔSmall Finds		Recorder <i>JS</i>
◇Samples		Date <i>29.8.06</i>
◻Building Materials		Initials

SITE OLR 00		CONTEXT RECORD		Context No. 126
Trench		Additional Sheets:		Type BRICK GRAVE
Site sub-div <i>South churchyard.</i>		Context Type: Deposit / Cut / Structure		Check Lists:
Structure No.		Overlain by:		DEPOSIT: 1.compaction 2.colour 3.composition 4.inclusions 5.thickness 6.extent 7.comments 8.method & conditions
Plan No. 4		Abutted by:		
Section No.		Cut by:		CUT: 1.shape in plan 2.base/sides/top profile 3.dimension and depth 4.sketch 5.truncation 6.fill nos 7.other comments
Co-Ordinates <i>from SE corner of church 7.5m W 5m S.</i>		Filled by:		
Level		Same as:		MASONRY: 1.materials 2.size of bricks etc 3.finish of stones 4.coursing/bond 5.form 6.faces 7.bond 8.dimensions as found 9.other comments
Slide No. 24		Part of:		
Neg No.		Consists of: (619) (620) (621) (622)		
Matrix location		Overlies:		
		Butts:		
		Cuts:		
		Fill of:		
		Relationships uncertain		

Description (See check lists):
1.1m wide, length? depends under extent of excavation (ledges - stone slab - plan 4. - base for monument - 1.80 x 0.90 x 0.10 m)

STRATIGRAPHIC MATRIX

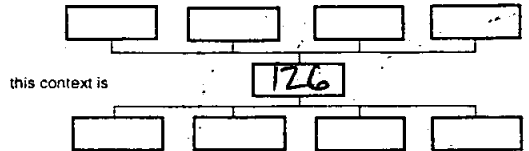

STRUCTURE UNDER SLAB 1.18 x 2.82 x > 0.10 m ^{DEEP} (EXTERNAL)
 INTERNAL - 0.73 x 2.36 x > 2.00 m.

RED BRICKS 220 x 100 x 60 mm YELLOW/WHITE MORTAR
 7 x 7 cm SQUARE IRON/STEEL BARS TO CARRY COFFINS. 50cm ^{3 WAY FOR} ^{BEHIND} ^{LEGS}

Interpretation/Discussion:
 BRICK GRAVE CAPPED WITH STONE SLABS AND LEDGER/BASE FOR MONUMENT. E W

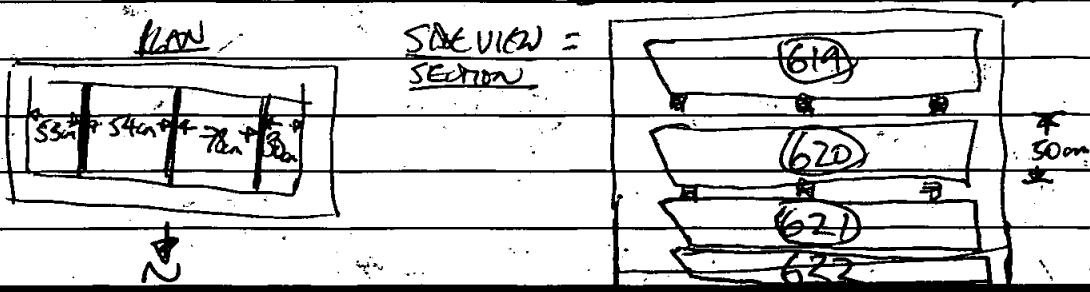

Finds (tick): None Pot Bone Flint Stone Burnt stone Glass Metal
 CBM Wood Leather

△ Small Finds	Recorder DS/VA
◇ Samples	Date 29. 8. 00
△ Building Materials	Initials

SITE

OL100

CONTEXT RECORD ADDITIONAL SHEET

Context No

126

NOTE:- AT BASE OF STRUCTURE A CHARNEZ PIT CONTAINING 2 WHOLE SKULLS / 2 FRAGMENTED SKULLS, VARIOUS RIBS ETC. - ABUTTING THE STUB END OF A NE-SW BRICK WALL

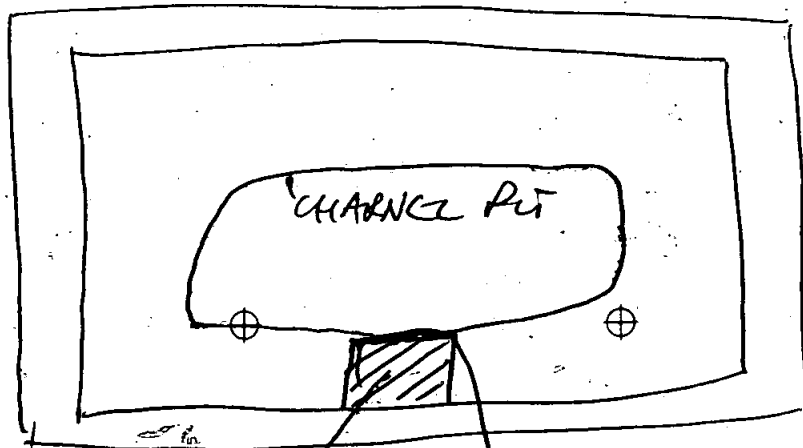

STUB END OF BRICK WALL

(level as for base of V. 126)

Oxford Archaeological Unit

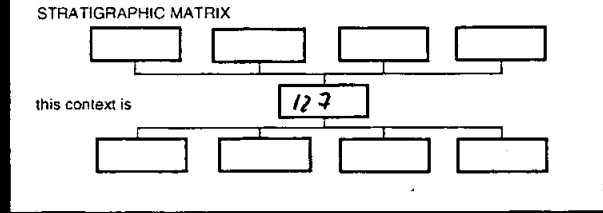
SITE <i>OLR 00</i>	CONTEXT RECORD		Context No. <i>127</i>
Trench	Additional Sheets:		Type <i>Ledger</i>
Site sub-div <i>Small churchyard.</i>	Context Type: <i>Deposit / Cut / Structure</i>		Check Lists:
Structure No.	Overlain by:	DEPOSIT: 1.compaction 2.colour 3.composition 4.inclusions 5.thickness 6.extent 7.comments 8.method & conditions	
Plan No. <i>A</i>	Abutted by:		
Section No.	Cut by:	CUT: 1.shape in plan 2.base/sides/top profile 3.dimension and depth 4.sketch 5.truncation 6.fill nos 7.other comments	
Co-Ordinates from SE corner of church. <i>2.5m S 7.5m W</i>	Filled by:		
Level	Same as:	MASONRY: 1.materials 2.size of bricks etc 3.finish of stones 4.coursing/bond 5.form 6.faces 7.bond 8.dimensions as found 9.other comments	
Slide No.	Part of:		
Neg No.	Consists of:		
Matrix location	Overlies:		
Description (See check lists):	Butts:	STRATIGRAPHIC MATRIX 	
<i>Dimensions = 1.75 x ? x 0.12m</i>	Cuts:		
	Fill of:	Relationships uncertain	
Interpretation/Discussion: <i>Stone Ledger</i>			
Finds (tick): None <input type="checkbox"/> Pot <input type="checkbox"/> Bone <input type="checkbox"/> Flint <input type="checkbox"/> Stone <input type="checkbox"/> Burnt stone <input type="checkbox"/> Glass <input type="checkbox"/> Metal <input type="checkbox"/>			
CBM <input type="checkbox"/> Wood <input type="checkbox"/> Leather <input type="checkbox"/>			
ΔSmall Finds	Recorder <i>DS</i>		
◇Samples	Date <i>29.8.06</i>		
ΔBuilding Materials	Initials		

Oxford Archaeological Unit

SITE		CONTEXT RECORD		Context No.
OLR 00		Additional Sheets:		128
Trench	Context Type: Deposit / Cut / Structure		Type ledger	
Site sub-div	Overlain by:		Check Lists:	
Structure No.	Abutted by:		DEPOSIT:	
Plan No.	Cut by:		1.compaction 2.colour 3.composition 4.inclusions 5.thickness 6.extent 7.comments 8.method & conditions	
Section No.	Filled by:		CUT:	
Co-Ordinates from SE corner	Same as:		1.shape in plan 2.base/sides/top profile 3.dimension and depth 4.sketch 5.truncation 6.fill nos 7.other comments	
Level	Part of:		MASONRY:	
Slide No.	Consists of:		1.materials 2.size of bricks etc 3.finish of stones 4.coursing/bond 5.form 6.faces 7.bond 8.dimensions as found 9.other comments	
Neg No.	Overlies:			
Matrix location	Butts:			
Description (See check lists):		Cuts:		
		Fill of:		
		Relationships uncertain		
Dimensions: 1.90 x 0.95 x 0.12 possible inscription but very worn.		STRATIGRAPHIC MATRIX 		
Interpretation/Discussion: Stone Ledger				
Finds (tick): None <input type="checkbox"/> Pot <input type="checkbox"/> Bone <input type="checkbox"/> Flint <input type="checkbox"/> Stone <input type="checkbox"/> Burnt stone <input type="checkbox"/> Glass <input type="checkbox"/> Metal <input type="checkbox"/> CBM <input type="checkbox"/> Wood <input type="checkbox"/> Leather <input type="checkbox"/>				
Δ Small Finds			Recorder DS	
◇ Samples			Date 29 8 00	
△ Building Materials			Initials	

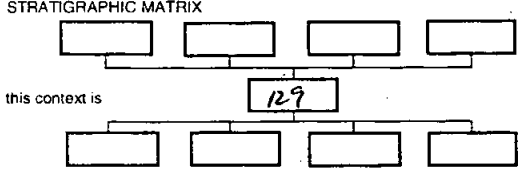
SITE <i>OLR00</i>	CONTEXT RECORD	Context No. <i>129</i>
	Additional Sheets:	Type <i>ledger</i>
Trench	Context Type: Deposit / Cut / Structure	Check Lists:
Site sub-div <i>South churchyard</i>	Overlain by:	DEPOSIT: 1.compaction 2.colour 3.composition 4.inclusions 5.thickness 6.extent 7.comments 8.method & conditions
Structure No.	Abutted by:	
Plan No. <i>4</i>	Cut by:	CUT: 1.shape in plan 2.base/sides/top profile 3.dimension and depth 4.sketch 5.truncation 6.fill nos 7.other comments
Section No.	Filled by:	
Co-Ordinates <i>from SE corner of church</i> <i>11.8m W</i> <i>4m S</i>	Same as:	MASONRY: 1.materials 2.size of bricks etc 3.finish of stones 4.coursing/bond 5.form 6.faces 7.bond 8.dimensions as found 9.other comments
Level	Part of:	
Slide No.	Consists of:	
Neg No.	Overlies:	
Matrix location	Butts:	
	Cuts:	
	Fill of:	
	Relationships uncertain	
Description (See check lists):		STRATIGRAPHIC MATRIX 
<i>dimensions: 1.80 x 0.95 x 0.10m</i> <i>cement traces on top for a monument.</i>		
Interpretation/Discussion: <i>stone ledger</i>		
Finds (tick): None <input type="checkbox"/> Pot <input type="checkbox"/> Bone <input type="checkbox"/> Flint <input type="checkbox"/> Stone <input type="checkbox"/> Burnt stone <input type="checkbox"/> Glass <input type="checkbox"/> Metal <input type="checkbox"/> CBM <input type="checkbox"/> Wood <input type="checkbox"/> Leather <input type="checkbox"/>		
ΔSmall Finds	Recorder <i>DS</i>	
◇Samples	Date <i>29 8 00</i>	
△Building Materials	Initials	

Oxford Archaeological Unit

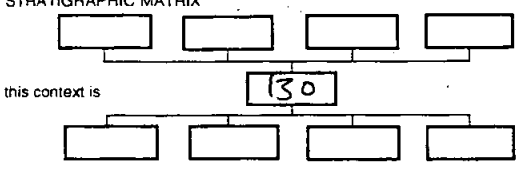
SITE <i>OLR 00</i>	CONTEXT RECORD		Context No. <i>130</i>
Trench	Additional Sheets:		Type <i>Headstone?</i>
Site sp-div <i>South churchyard</i>	Context Type: <i>Deposit / Cut / Structure</i>		Check Lists:
Structure No.	Overlain by:	DEPOSIT: 1.compaction 2.colour 3.composition 4.inclusions 5.thickness 6.extent 7.comments 8.method & conditions	
Plan No. <i>4</i>	Abutted by:		
Section No.	Cut by:	CUT: 1.shape in plan 2.base/sides/top profile 3.dimension and depth 4.sketch 5.function 6.fill nos 7.other comments	
Co-Ordinates	Filled by:		
Level	Same as:	MASONRY: 1.materials 2.size of bricks etc 3.finish of stones 4.coursing/bond 5.form 6.faces 7.bond 8.dimensions as found 9.other comments	
Slide No.	Part of:		
Neg No.	Consists of:		
Matrix location	Overlies:		
Description (See check lists):	Butts:	STRATIGRAPHIC MATRIX 	
<i>Slate</i>	Cuts:		
<i>Dimensions: 1.9 x 0.9 x 0.08m</i>	Fill of:		
<i>laid down headstone: inscription at top</i>	Relationships uncertain		
Interpretation/Discussion:			
<i>Reuumbert Headstone</i>		<i>Sacred</i>	
		<i>to the memory of -</i>	
		<i>Charles Read etc</i>	
		<i>- c of Downe Hall in the county -</i>	
		<i>Dorset: who died the 25th March</i>	
		<i>1830 Aged 46 years</i>	
Finds (tick): None <input type="checkbox"/> Pot <input type="checkbox"/> Bone <input type="checkbox"/> Flint <input type="checkbox"/> Stone <input type="checkbox"/> Burnt stone <input type="checkbox"/> Glass <input type="checkbox"/> Metal <input type="checkbox"/> CBM <input type="checkbox"/> Wood <input type="checkbox"/> Leather <input type="checkbox"/>			
△Small Finds			Recorder <i>DS</i>
◇Samples			Date <i>29.11</i>
△Building Materials			Initials

Oxford Archaeological Unit

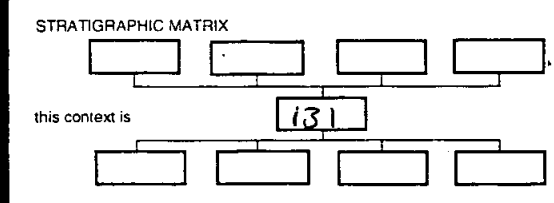
SITE <i>OLR00</i>	CONTEXT RECORD		Context No. <i>131</i>
	Additional Sheets:		Type <i>ledge</i>
Trench	Context Type: <i>Deposit / Cut / Structure</i>		Check Lists:
Site sub-div <i>South churchyard</i>	Overlain by:	DEPOSIT: 1.compaction 2.colour 3.composition 4.inclusions 5.thickness 6.extent 7.comments 8.method & conditions <hr/> CUT: 1.shape in plan 2.base/sides/top profile 3.dimension and depth 4.sketch 5.truncation 6.fill nos 7.other comments <hr/> MASONRY: 1.materials 2.size of bricks etc 3.finish of stones 4.coursing/bond 5.form 6.faces 7.bond 8.dimensions as found 9.other comments	
Structure No.	Abutted by:		
Plan No. <i>4</i>	Cut by:		
Section No.	Filled by:		
Co-Ordinates <i>from SE corner of church</i> <i>14.5N</i> <i>6.5S.</i>	Same as:		
Level	Part of:		
Slide No.	Consists of:		
Neg No.	Overlies:		
Matrix location	Butts:		
	Cuts:		
	Fill of:		
	Relationships uncertain		
Description (See check lists):		STRATIGRAPHIC MATRIX  this context is <i>131</i>	
<i>Dimensions: 1.6 x 0.9 x 0.09m</i>			
Interpretation/Discussion:			
<i>Stone ledger</i>			
Finds (tick): None <input type="checkbox"/> Pot <input type="checkbox"/> Bone <input type="checkbox"/> Flint <input type="checkbox"/> Stone <input type="checkbox"/> Burnt stone <input type="checkbox"/> Glass <input type="checkbox"/> Metal <input type="checkbox"/> CBM <input type="checkbox"/> Wood <input type="checkbox"/> Leather <input type="checkbox"/>			
△Small Finds		Recorder <i>DS</i>	
◇Samples		Date <i>29 8 00</i>	
△Building Materials		Initials	

Oxford Archaeological Unit

SITE		CONTEXT RECORD		Context No.
OLR 00		Additional Sheets:		132
Trench	Context Type: Deposit / Cut / Structure			Type <i>ledger</i>
Site sub-div <i>South churchyard</i>	Overlain by:	Check Lists:		
Structure No.	Abutted by:	DEPOSIT:		
Plan No. <i>A</i>	Cut by:	1.compaction 2.colour 3.composition 4.inclusions 5.thickness 6.extent 7.comments 8.method & conditions		
Section No. <i>-</i>	Filled by:	CUT:		
Co-Ordinates <i>from SE corner of church</i> <i>16.5m W</i> <i>5.5m S</i>	Same as:	1.shape in plan 2.base/sides/top profile 3.dimension and depth 4.sketch 5.function 6.fill pos 7.other comments		
Level	Part of:	MASONRY:		
Slide No.	Consists of:	1.materials 2.size of bricks etc 3.finish of stones 4.coursing/bond 5.form 6.faces 7.bond 8.dimensions as found 9.other comments		
Neg No.	Overlies:			
Matrix location	Butts:			
Description (See check lists):		STRATIGRAPHIC MATRIX		
		<p>Diagram description: A stratigraphic matrix diagram with four boxes in a top row and four boxes in a bottom row. A central box in the bottom row is labeled '132'. Lines connect the central box to the boxes above and below it, and also to the boxes on either side in the bottom row.</p>		
<i>Dimensions: 1.9 x 0.9 x 0.11 m</i>				
Interpretation/Discussion:				
<i>Stone Ledger</i>				
Finds (tick): None <input type="checkbox"/> Pot <input type="checkbox"/> Bone <input type="checkbox"/> Flint <input type="checkbox"/> Stone <input type="checkbox"/> Burnt stone <input type="checkbox"/> Glass <input type="checkbox"/> Metal <input type="checkbox"/> CBM <input type="checkbox"/> Wood <input type="checkbox"/> Leather <input type="checkbox"/>				
ΔSmall Finds			Recorder <i>DS</i>	
◇Samples			Date <i>29 8 00</i>	
△Building Materials			Initials	

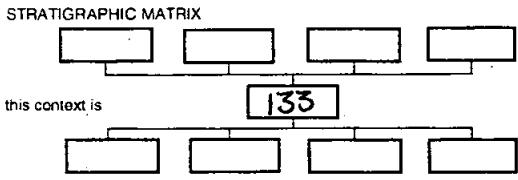
SITE <i>OLR 00</i>	CONTEXT RECORD	Context No. <i>133</i>
Trench	Additional Sheets:	Type <i>ledge</i>
Site sub-div <i>Small churchyard</i>	Context Type: Deposit / Cut / Structure	Check Lists:
Structure No.	Overlain by:	DEPOSIT: 1.compaction 2.colour 3.composition 4.inclusions 5.thickness 6.extent 7.comments 8.method & conditions
Plan No. <i>↑</i>	Abutted by:	
Section No.	Cut by:	CUT: 1.shape in plan 2.base/sides/top profile 3.dimension and depth 4.sketch 5.function 6.fill nos 7.other comments
Co-Ordinates <i>from SE corner of church</i> <i>16m W, 2.5m S.</i>	Filled by:	
Level	Same as:	MASONRY: 1.materials 2.size of bricks etc 3.finish of stones 4.coursing/bond 5.form 6.faces 7.bond 8.dimensions as found 9.other comments
Slide No.	Part of:	
Neg No.	Consists of:	
Matrix location	Overlies:	
	Butts:	
Description (See check lists):		STRATIGRAPHIC MATRIX  this context is 133
<i>Dimensions: 1.75 x 0.8 m</i>		
Interpretation/Discussion: <i>Stone ledge</i>		
Finds (tick): None <input type="checkbox"/> Pot <input type="checkbox"/> Bone <input type="checkbox"/> Flint <input type="checkbox"/> Stone <input type="checkbox"/> Burnt stone <input type="checkbox"/> Glass <input type="checkbox"/> Metal <input type="checkbox"/> CBM <input type="checkbox"/> Wood <input type="checkbox"/> Leather <input type="checkbox"/>		
ΔSmall Finds	Recorder <i>DS</i>	
◇Samples	Date <i>28 9 00</i>	
△Building Materials	Initials	

Oxford Archaeological Unit

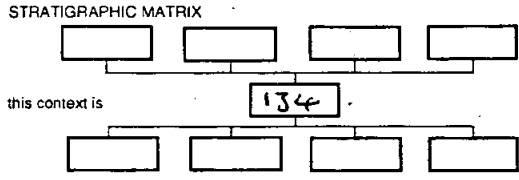
SITE		CONTEXT RECORD		Context No. 134
OLR00		Additional Sheets:		Type ledge
Trench	Context Type: Deposit / Cut / Structure			Check Lists:
Site sub-div <i>South churchyard</i>	Overlain by:	DEPOSIT: 1.compaction 2.colour 3.composition 4.inclusions 5.thickness 6.extent 7.comments 8.method & conditions CUT: 1.shape in plan 2.base/sides/top profile 3.dimension and depth 4.sketch 5.truncation 6.fill nos 7.other comments MASONRY: 1.materials 2.size of bricks etc 3.finish of stones 4.coursing/bond 5.form 6.faces 7.bond 8.dimensions as found 9.other comments		
Structure No.	Abutted by:			
Plan No. 4	Cut by:			
	Filled by:			
Section No.	Same as:			
	Part of:			
Co-Ordinates <i>from SE corner of church</i>	Consists of:			
14 W 11.5m S.	Overlies:			
Level	Butts:			
Slide No.	Cuts:			
Neg No.	Fill of:			
Matrix location	Relationships uncertain			
Description (See check lists):				STRATIGRAPHIC MATRIX 
<i>Dimensions 1.8 x 0.8 x 0.12m</i>				
Interpretation/Discussion:				
<i>Pure ledge</i>				
Finds (tick): None <input type="checkbox"/> Pot <input type="checkbox"/> Bone <input type="checkbox"/> Flint <input type="checkbox"/> Stone <input type="checkbox"/> Burnt stone <input type="checkbox"/> Glass <input type="checkbox"/> Metal <input type="checkbox"/> CBM <input type="checkbox"/> Wood <input type="checkbox"/> Leather <input type="checkbox"/>				
△Small Finds			Recorder DS	
◇Samples			Date 29 8 00	
△Building Materials			Initials	

Oxford Archaeological Unit

SITE <i>OLR00</i>		CONTEXT RECORD		Context No. 135
Trench		Additional Sheets:		Type <i>Ledge</i>
Site sub div <i>Small churchyard</i>		Context Type: Deposit / Cut / Structure		Check Lists:
Structure No.		Overlain by:		DEPOSIT: 1.compaction 2.colour 3.composition 4.inclusions 5.thickness 6.extent 7.comments 8.method & conditions
Plan No. 4		Abutted by:		
Section No.		Cut by:		CUT: 1.shape in plan 2.base/sides/top profile 3.dimension and depth 4.sketch & truncation 6.fill pos 7.other comments
Co-Ordinates <i>From SE corner of church</i> 9.5S 14.5W		Filled by:		
Level		Same as:		MASONRY: 1.materials 2.size of bricks etc 3.finish of stones 4.coursing/bond 5.form 6.faces 7.bond 8.dimensions as found 9.other comments
Slide No.		Part of:		
Neg No.		Consists of:		
Matrix location		Overlies:		
Description (See check lists):		Butts:		
<i>Slate</i>		Cuts:		
<i>Dimensions, 2 x 0.9 x 0.12m.</i>		Fill of:		
<i>Inscription Succeeded to the Memory of</i>		Relationships uncertain		
<i>Mrs Ann Ricardo</i>		STRATIGRAPHIC MATRIX		
<i>wife of Mr Benjamin Ricardo</i>				
<i>of Winger Terrace City Road</i>		this context is		
<i>who departed this life Dec 27th 1814.</i>				
Interpretation/Discussion:				
<i>in the 28th year of her life.</i>				
<i>Set down headstone.</i>				
<i>Remembers Headstone.</i>				
Finds (tick): None <input type="checkbox"/> Pot <input type="checkbox"/> Bone <input type="checkbox"/> Flint <input type="checkbox"/> Stone <input type="checkbox"/> Burnt stone <input type="checkbox"/> Glass <input type="checkbox"/> Metal <input type="checkbox"/> CBM <input type="checkbox"/> Wood <input type="checkbox"/> Leather <input type="checkbox"/>				
Δ Small Finds			Recorder <i>DS</i>	
◇ Samples			Date <i>29 5 00</i>	
△ Building Materials			Initials <i>DS</i>	

Oxford Archaeological Unit

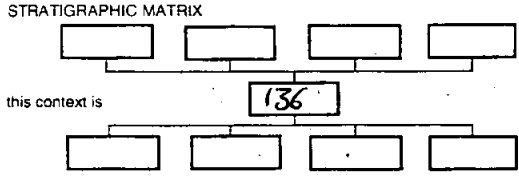
SITE		CONTEXT RECORD		Context No. 136
OLR 00		Additional Sheets:		Type <i>ledger</i>
Trench	Context Type: Deposit / Cut / Structure		Check Lists:	
Site sub-div <i>Small chancel</i>	Overlain by:		DEPOSIT: 1.compaction 2.colour 3.composition 4.inclusions 5.thickness 6.extent 7.comments 8.method & conditions	
Structure No.	Abutted by:			
Plan No. 4	Cut by:		CUT: 1.shape in plan 2.base/sides/top profile 3.dimension and depth 4.sketch 5.truncation 6.fill pos 7.other comments	
	Filled by:			
Section No.	Same as:		MASONRY: 1.materials 2.size of bricks etc 3.finish of stones 4.coursing/bond 5.form 6.faces 7.bond 8.dimensions as found 9.other comments	
	Part of:			
Co-Ordinates <i>from SE corner of chancel.</i> 16 W 11-5N 11-5S	Consists of:			
	Overlies:			
Level	Butts:			
Slide No.	Cuts:			
Neg No.	Fill of:			
Matrix location	Relationships uncertain			
Description (See check lists):			STRATIGRAPHIC MATRIX 	
<i>Dimensions: 2 x 1.5 x 0.13m</i>				
Interpretation/Discussion: <i>Stone Ledger</i>				
Finds (tick): None <input type="checkbox"/> Pot <input type="checkbox"/> Bone <input type="checkbox"/> Flint <input type="checkbox"/> Stone <input type="checkbox"/> Burnt stone <input type="checkbox"/> Glass <input type="checkbox"/> Metal <input type="checkbox"/> CBM <input type="checkbox"/> Wood <input type="checkbox"/> Leather <input type="checkbox"/>				
△Small Finds			Recorder <i>JS</i>	
◇Samples			Date <i>28 8 00</i>	
△Building Materials			Initials	

Oxford Archaeological Unit

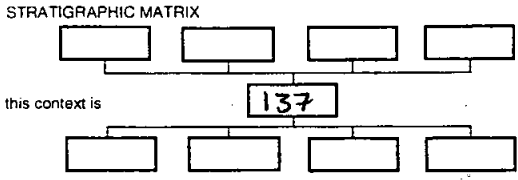
SITE		CONTEXT RECORD		Context No. 137
OLR 00		Additional Sheets:		Type <i>ledger</i>
Trench	Context Type: Deposit / Cut / Structure			Check Lists:
Site sub-div <i>South churchyard</i>	Overlain by:			DEPOSIT: 1.compaction 2.colour 3.composition 4.inclusions 5.thickness 6.extent 7.comments 8.method & conditions
Structure No.	Abutted by:			
Plan No. 4	Cut by:			CUT: 1.shape in plan 2.base/sides/top profile 3.dimension and depth 4.sketch 5.truncation 6.fill nos 7.other comments
	Filled by:			
Section No.	Same as:			MASONRY: 1.materials 2.size of bricks etc 3.finish of stones 4.coursing/bond 5.form 6.faces 7.bond 8.dimensions as found 9.other comments
	Part of:			
Co-Ordinates <i>from SE corner of church</i> 18m W 11.5m S	Consists of:			
	Overlies:			
Level	Butts:			
Slide No.	Cuts:			
Neg No.	Fill of:			
Matrix location	Relationships uncertain			
Description (See check lists):				STRATIGRAPHIC MATRIX 
<i>Dimensions: 1.8 x 0.85 x 0.11m</i>				
Interpretation/Discussion:				
<i>Stone ledger.</i>				
Finds (tick): None <input type="checkbox"/> Pot <input type="checkbox"/> Bone <input type="checkbox"/> Flint <input type="checkbox"/> Stone <input type="checkbox"/> Burnt stone <input type="checkbox"/> Glass <input type="checkbox"/> Metal <input type="checkbox"/> CBM <input type="checkbox"/> Wood <input type="checkbox"/> Leather <input type="checkbox"/>				
ΔSmall Finds			Recorder <i>DS</i>	
◇Samples			Date <i>29.8.00</i>	
△Building Materials			Initials	

Oxford Archaeological Unit

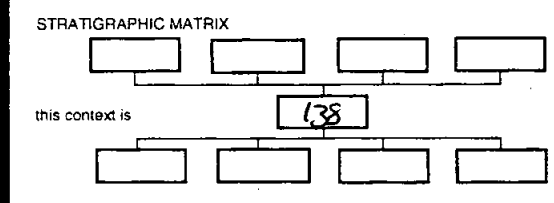
SITE <i>OLR00</i>	CONTEXT RECORD	Context No. <i>138</i>
Trench	Additional Sheets:	Type <i>ledger</i>
Site sub-div <i>South churchyard</i>	Context Type: Deposit / Cut / Structure	Check Lists:
Structure No.	Overlain by:	DEPOSIT: 1.compaction 2.colour 3.composition 4.inclusions 5.thickness 6.extent 7.comments 8.method & conditions
Plan No. <i>4</i>	Abutted by:	
Section No.	Cut by:	CUT: 1.shape in plan 2.base/sides/top profile 3.dimension and depth 4.sketch 5.truncation 6.fill nos 7.other comments
Co-Ordinates <i>from SE corner of church.</i> <i>19.5m W, 11.5m S</i>	Filled by:	
Level	Same as:	MASONRY: 1.materials 2.size of bricks etc 3.finish of stones 4.coursing/bond 5.form 6.faces 7.bond 8.dimensions as found 9.other comments
Slide No.	Part of:	
Neg No.	Consists of:	
Matrix location	Overlies:	
	Butts:	
Description (See check lists):	Cuts:	
<i>Dimensions: 1.8 x 0.9 x 0.1m</i>	Fill of:	
	Relationships uncertain	
		STRATIGRAPHIC MATRIX  this context is 138
Interpretation/Discussion:		
<i>Stone Ledger.</i>		
Finds (tick): None <input type="checkbox"/> Pot <input type="checkbox"/> Bone <input type="checkbox"/> Flint <input type="checkbox"/> Stone <input type="checkbox"/> Burnt stone <input type="checkbox"/> Glass <input type="checkbox"/> Metal <input type="checkbox"/> CBM <input type="checkbox"/> Wood <input type="checkbox"/> Leather <input type="checkbox"/>		
ΔSmall Finds	Recorder <i>DS</i>	
◇Samples	Date <i>28 8 00</i>	
△Building Materials	Initials	

Oxford Archaeological Unit

SITE <i>OLR00</i>		CONTEXT RECORD		Context No. <i>139</i>
Trench		Additional Sheets:		Type <i>ledger</i>
Context Type: <i>Deposit / Cut / Structure</i>		Check Lists:		
Site sub-div <i>South churchyard</i>	Overlain by:	DEPOSIT:		
Structure No.	Abutted by:	1.compaction 2.colour 3.composition 4.inclusions 5.thickness 6.extent 7.comments 8.method & conditions		
Plan No. <i>4</i>	Cut by:	CUT:		
	Filled by:	1.shape in plan 2.base/sides/top profile 3.dimension and depth 4.sketch 5.truncation 6.fill nos 7.other comments		
Section No.	Same as:	MASONRY:		
	Part of:	1.materials 2.size of bricks etc 3.finish of stones 4.coursing/bond 5.form 6.faces 7.bond 8.dimensions as found 9.other comments		
Co-Ordinates <i>from SE corner of church.</i> <i>(7m W) 19.5m S.</i>	Consists of:			
Level	Overlies:			
Slide No.	Butts:			
Neg No.	Cuts:			
Matrix location	Fill of:			
Description (See check lists):		Relationships uncertain		
<i>Dimensions: 1.95 x 0.95 x 0.1.</i>		STRATIGRAPHIC MATRIX		
		<pre> graph TD A[] --- B[] A --- C[] A --- D[] A --- E[] B --- F[] C --- F[] D --- F[] E --- F[] F --- G[] F --- H[] F --- I[] F --- J[] style A fill:#fff,stroke:#000 style B fill:#fff,stroke:#000 style C fill:#fff,stroke:#000 style D fill:#fff,stroke:#000 style E fill:#fff,stroke:#000 style F fill:#fff,stroke:#000 style G fill:#fff,stroke:#000 style H fill:#fff,stroke:#000 style I fill:#fff,stroke:#000 style J fill:#fff,stroke:#000 </pre>		
		this context is <i>139</i>		
Interpretation/Discussion: <i>Stone ledger.</i>				
Finds (tick): None <input type="checkbox"/> Pot <input type="checkbox"/> Bone <input type="checkbox"/> Flint <input type="checkbox"/> Stone <input type="checkbox"/> Burnt stone <input type="checkbox"/> Glass <input type="checkbox"/> Metal <input type="checkbox"/> CBM <input type="checkbox"/> Wood <input type="checkbox"/> Leather <input type="checkbox"/>				
ΔSmall Finds			Recorder <i>JS</i>	
◇Samples			Date <i>28 8 00</i>	
△Building Materials			Initials	

Oxford Archaeological Unit

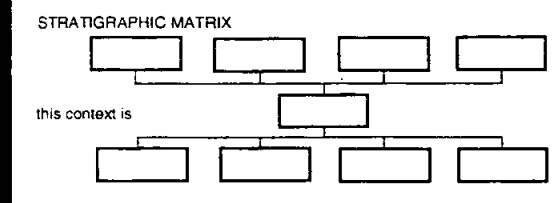
SITE OLROO	CONTEXT RECORD	Context No. 140
	Additional Sheets:	Type <i>ledger</i>
Trench	Context Type: Deposit / Cut / Structure	Check Lists:
Site sub- ^{div} <i>South churchyard</i>	Overlain by:	DEPOSIT: 1.compaction 2.colour 3.composition 4.inclusions 5.thickness 6.extent 7.comments 8.method & conditions
Structure No.	Abutted by:	
Plan No. 4	Cut by:	CUT: 1.shape in plan 2.base/sides/top profile 3.dimension and depth 4.sketch 5.function 6.fill nos 7.other comments
	Filled by:	
Section No.	Same as:	MASONRY: 1.materials 2.size of bricks etc 3.finish of stones 4.coursing/bond 5.form 6.faces 7.bond 8.dimensions as found 9.other comments
	Part of:	
Co-Ordinates <i>from SE corner of Church.</i> 17m W 10m S.	Consists of:	
Level	Overlies:	
Slide No.	Butts:	
Neg No.	Cuts:	
Matrix location	Fill of:	
	Relationships uncertain	
Description (See check lists):		STRATIGRAPHIC MATRIX 
Dimensions: 1.8 x 0.9 x 0.08m		
Interpretation/Discussion:		
<i>Stone ledger</i>		
Finds (tick): None <input type="checkbox"/> Pot <input type="checkbox"/> Bone <input type="checkbox"/> Flint <input type="checkbox"/> Stone <input type="checkbox"/> Burnt stone <input type="checkbox"/> Glass <input type="checkbox"/> Metal <input type="checkbox"/> CBM <input type="checkbox"/> Wood <input type="checkbox"/> Leather <input type="checkbox"/>		
ΔSmall Finds		Recorder <i>DS</i>
◇Samples		Date <i>29 8 00</i>
△Building Materials		Initials

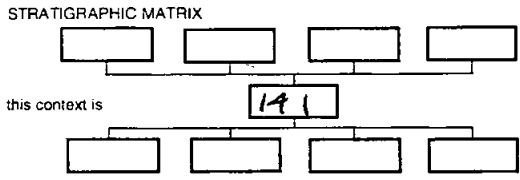
SITE <i>OLR00</i>	CONTEXT RECORD	Context No. <i>141</i>
	Additional Sheets:	Type <i>ledge</i>
Trench	Context Type: Deposit / Cut / Structure	Check Lists:
Site sub-div <i>South churchyard</i>	Overlain by:	DEPOSIT: 1.compaction 2.colour 3.composition 4.inclusions 5.thickness 6.extent 7.comments 8.method & conditions
Structure No.	Abutted by:	
Plan No. <i>↑</i>	Cut by:	CUT: 1.shape in plan 2.base/sides/top profile 3.dimension and depth 4.sketch 5.truncation 6.fill nos 7.other comments
	Filled by:	
Section No.	Same as:	MASONRY: 1.materials 2.size of bricks etc 3.finish of stones 4.coursing/bond 5.form 6.faces 7.bond 8.dimensions as found 9.other comments
	Part of:	
Co-Ordinates <i>from SE corner of chapel</i> <i>19.6m, 9.5m S.</i>	Consists of:	
Level	Overlies:	
Slide No.	Butts:	
Neg No.	Cuts:	
Matrix location	Fill of:	
	Relationships uncertain	
Description (See check lists):		STRATIGRAPHIC MATRIX  this context is
<i>Dimensions: ? x 0.85 x 0.08m</i>		
Interpretation/Discussion:		
<i>Stone Ledges.</i>		
Finds (tick): None <input type="checkbox"/> Pot <input type="checkbox"/> Bone <input type="checkbox"/> Flint <input type="checkbox"/> Stone <input type="checkbox"/> Burnt stone <input type="checkbox"/> Glass <input type="checkbox"/> Metal <input type="checkbox"/> CBM <input type="checkbox"/> Wood <input type="checkbox"/> Leather <input type="checkbox"/>		
△Small Finds	Recorder <i>DS</i>	
◇Samples	Date <i>29 8 00</i>	
△Building Materials	Initials	

Oxford Archaeological Unit

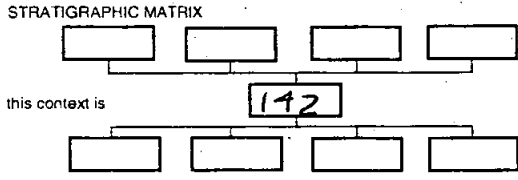
SITE	CONTEXT RECORD		Context No. 142
0LR00	Additional Sheets:		Type <i>ledger</i>
Trench	Context Type: Deposit / Cut / Structure		Check Lists:
Site sub- ^{div} <i>South churchyard</i>	Overlain by:	DEPOSIT: 1.compaction 2.colour 3.composition 4.inclusions 5.thickness 6.extent 7.comments 8.method & conditions <hr/> CUT: 1.shape in plan 2.base/sides/top profile 3.dimension and depth 4.sketch 5.truncation 6.fill nos 7.other comments <hr/> MASONRY: 1.materials 2.size of bricks etc 3.finish of stones 4.coursing/bond 5.form 6.faces 7.bond 8.dimensions as found 9.other comments	
Structure No.	Abutted by:		
Plan No. <i>4</i>	Cut by:		
	Filled by:		
Section No.	Same as:		
	Part of:		
Co-Ordinates <i>from SE corner of church</i> <i>19m W 8m S.</i>	Consists of:		
	Overlies:		
Level	Butts:		
Slide No.	Cuts:		
Neg No.	Fill of:		
Matrix location	Relationships uncertain		
Description (See check lists):		STRATIGRAPHIC MATRIX 	
<i>Dimensions: 2 x 1.05 x 0.1m</i>			
Interpretation/Discussion:			
<i>Stone Ledger</i>			
Finds (tick): None <input type="checkbox"/> Pot <input type="checkbox"/> Bone <input type="checkbox"/> Flint <input type="checkbox"/> Stone <input type="checkbox"/> Burnt stone <input type="checkbox"/> Glass <input type="checkbox"/> Metal <input type="checkbox"/> CBM <input type="checkbox"/> Wood <input type="checkbox"/> Leather <input type="checkbox"/>			
ΔSmall Finds		Recorder <i>JS</i>	
◇Samples		Date <i>29 8 00</i>	
△Building Materials		Initials	

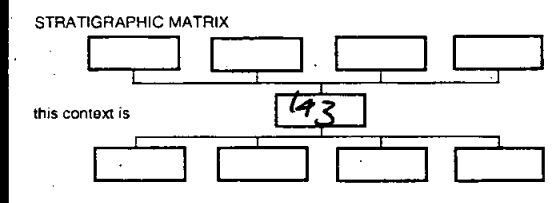
SITE	CONTEXT RECORD	Context No.
OLR 00	Additional Sheets:	143
Trench	Context Type: Deposit / Cut / Structure	Type <i>ledge</i>
Site sub-div <i>South churchyard</i>	Overlain by:	Check Lists:
Structure No.	Abutted by:	DEPOSIT:
Plan No. <i>4</i>	Cut by:	1.compaction 2.colour 3.composition 4.inclusions 5.thickness 6.extent 7.comments 8.method & conditions
Section No.	Filled by:	CUT:
Co-Ordinates <i>from SE corner of church</i> <i>19.5W, 6.5m S.</i>	Same as:	1.shape in plan 2.base/sides/top profile 3.dimension and depth 4.sketch 5.truncation 6.fill nos 7.other comments
Level	Part of:	MASONRY:
Slide No.	Consists of:	1.materials 2.size of bricks etc 3.finish of stones 4.coursing/bond 5.form 6.faces 7.bond 8.dimensions as found 9.other comments
Neg No.	Overlies:	
Matrix location	Butts:	
	Cuts:	
	Fill of:	
	Relationships uncertain	
Description (See check lists):		STRATIGRAPHIC MATRIX 
<i>Dimensions: 1.95 x 0.8 x 0.1m</i>		
Interpretation/Discussion:		
<i>Stone Ledge</i>		
Finds (tick): None <input type="checkbox"/> Pot <input type="checkbox"/> Bone <input type="checkbox"/> Flint <input type="checkbox"/> Stone <input type="checkbox"/> Burnt stone <input type="checkbox"/> Glass <input type="checkbox"/> Metal <input type="checkbox"/> CBM <input type="checkbox"/> Wood <input type="checkbox"/> Leather <input type="checkbox"/>		
ΔSmall Finds	Recorder <i>JS</i>	
◇Samples	Date <i>29 8 00</i>	
△Building Materials	Initials	

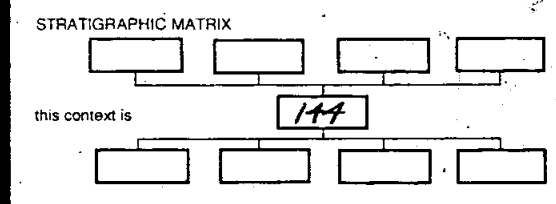
SITE OLR 00		CONTEXT RECORD		Context No. 144
Trench		Additional Sheets:		Type ledger
Context Type: Deposit / Cut / Structure		Check Lists:		DEPOSIT:
Site sub-div South Churchyard	Overlain by:	1.compaction 2.colour 3.composition 4.inclusions 5.thickness 6.extent 7.comments 8.method & conditions		
Structure No.	Abutted by:			
Plan No. T + G	Cut by:	CUT: 1.shape in plan 2.base/sides/top profile 3.dimension and depth 4.sketch 5.truncation 6.fill nos 7.other comments		
	Filled by:			
Section No.	Same as:	MASONRY: 1.materials 2.size of bricks etc 3.finish of stones 4.coursing/bond 5.form 6.faces 7.bond 8.dimensions as found 9.other comments		
	Part of:			
Co-Ordinates from SE corner of church 22m W, 5.5m S.	Consists of:			
Level	Overlies:			
Slide No.	Butts:			
Neg No.	Cuts:			
Matrix location	Fill of:			
Description (See check lists):		Relationships uncertain		
Total = 2.55m E-W x 1.6m N-S. Slabs		STRATIGRAPHIC MATRIX  this context is		
Individually = 0.85m x 1.6m				
BRICK GRAVE STRUCTURE — 2.80 x 1.75 m DEPTH: 1.60 m				
Interpretation/Discussion: Brick Grave covered by 3 stone slabs. SLABS COVERING BRICK GRAVE STRUCTURE WITH SUGGESTED CURVED WALLS MAKING INTERIOR CONCAVE AND EXTERIOR CONVEX. CONTAINING BURIALS: (1166) (1167) (1168) (1169) (1170) (1171) (1172) SKETCH: NO FLOORING TO THE STRUCTURE JUST WALLS ON TOP OF BRICK/ARTH NATURAL.				
Finds (tick): None <input type="checkbox"/> Pot <input type="checkbox"/> Bone <input type="checkbox"/> Flint <input type="checkbox"/> Stone <input type="checkbox"/> Burnt stone <input type="checkbox"/> Glass <input type="checkbox"/> Metal <input type="checkbox"/> CBM <input type="checkbox"/> Wood <input type="checkbox"/> Leather <input type="checkbox"/>				
△Small Finds		Recorder JS DM		
◇Samples		Date 29 8 00 06/12/00		
△Building Materials		Initials		

Oxford Archaeological Unit

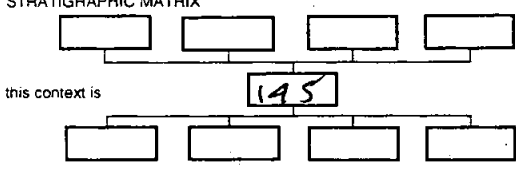
SITE <i>OLR00</i>	CONTEXT RECORD		Context No. <i>145</i>
Trench	Additional Sheets:		Type <i>Ledge</i>
Site sub-div <i>South churchyard</i>	Context Type: <i>Deposit / Cut / Structure</i>		Check Lists:
Structure No.	Overlain by:	DEPOSIT: 1.compaction 2.colour 3.composition 4.inclusions 5.thickness 6.extent 7.comments 8.method & conditions	
Plan No. <i>4</i>	Abutted by:		
	Cut by:		
	Filled by:		
Section No.	Same as:	CUT: 1.shape in plan 2.base/sides/top profile 3.dimension and depth 4.sketch 5.truncation 6.fill nos 7.other comments	
	Part of:		
Co-Ordinates <i>from SE corner of church</i> <i>22.5W, 10.5m S.</i>	Consists of:	MASONRY: 1.materials 2.size of bricks etc 3.finish of stones 4.coursing/bond 5.form 6.faces 7.bond 8.dimensions as found 9.other comments	
Level	Overlies:		
Slide No.	Butts:		
Neg No.	Cuts:		
Matrix location	Fill of:		
	Relationships uncertain		
Description (See check lists):		STRATIGRAPHIC MATRIX 	
<i>Dimensions: 1.85 x 0.75 x 0.15m</i>			
Interpretation/Discussion:			
<i>Stone Ledge</i>			
Finds (tick): None <input type="checkbox"/> Pot <input type="checkbox"/> Bone <input type="checkbox"/> Flint <input type="checkbox"/> Stone <input type="checkbox"/> Burnt stone <input type="checkbox"/> Glass <input type="checkbox"/> Metal <input type="checkbox"/> CBM <input type="checkbox"/> Wood <input type="checkbox"/> Leather <input type="checkbox"/>			
ΔSmall Finds			Recorder <i>DS</i>
◇Samples			Date <i>29 8 00</i>
△Building Materials			Initials

SITE		CONTEXT RECORD		Context No.
OLR00		Additional Sheets:		146
Trench	Context Type: Deposit / Cut / Structure			Check Lists:
Site sub-div <i>South chancel</i>	Overlain by:			DEPOSIT: 1.compaction 2.colour 3.composition 4.inclusions 5.thickness 6.extent 7.comments 8.method & conditions
Structure No.	Abutted by:			
Plan No. 4	Cut by:			CUT: 1.shape in plan 2.base/sides/top profile 3.dimension and depth 4.sketch 5.truncation 6.fill nos 7.other comments
	Filled by:			
Section No.	Same as:			MASONRY: 1.materials 2.size of bricks etc 3.finish of stones 4.coursing/bond 5.form 6.faces 7.bond 8.dimensions as found 9.other comments
	Part of:			
Co-Ordinates <i>from SE corner of church.</i> 25.5W, 11.5S	Consists of:			
Level	Overlies:			
Slide No.	Butts:			
Neg No.	Cuts:			
Matrix location	Fill of:			
		Relationships uncertain		
Description (See check lists):				STRATIGRAPHIC MATRIX
1.86m x 0.97m x 0.1m				
Interpretation/Discussion:				
<i>Stone Ledger.</i>				
Finds (tick): None <input type="checkbox"/> Pot <input type="checkbox"/> Bone <input type="checkbox"/> Flint <input type="checkbox"/> Stone <input type="checkbox"/> Burnt stone <input type="checkbox"/> Glass <input type="checkbox"/> Metal <input type="checkbox"/> CBM <input type="checkbox"/> Wood <input type="checkbox"/> Leather <input type="checkbox"/>				
ΔSmall Finds				Recorder <i>DJ</i>
◇Samples				Date <i>4 9 00</i> 29 4 00
△Building Materials				Initials

SITE	CONTEXT RECORD	Context No.
OLR00	Additional Sheets:	147
Trench	Context Type: Deposit / Cut / Structure	Type <i>ledge</i>
Site sub-div <i>South churchyard</i>	Overlain by:	Check Lists:
Structure No.	Abutted by:	DEPOSIT:
Plan No. <i>4</i>	Cut by:	1.compaction 2.colour 3.composition 4.inclusions 5.thickness 6.extent 7.comments 8.method & conditions
Section No.	Filled by:	CUT:
Co-Ordinates <i>from SE corner of church</i> <i>28m W, 12.3m S.</i>	Same as:	1.shape in plan 2.base/sides/top profile 3.dimension and depth 4.sketch 5.truncation 6.fill nos 7.other comments
Level	Part of:	MASONRY:
Slide No.	Consists of:	1.materials 2.size of bricks etc 3.finish of stones 4.coursing/bond 5.form 6.faces 7.bond 8.dimensions as found 9.other comments
Neg No.	Overlies:	
Matrix location	Butts:	
	Cuts:	
	Fill of:	
	Relationships uncertain	
Description (See check lists):		<p>STRATIGRAPHIC MATRIX</p> <p>1.97m long, width covered by spoil & extent of excavation. x 0.11m</p>
Interpretation/Discussion:		
<i>Stone ledge</i>		
Finds (tick): None <input type="checkbox"/> Pot <input type="checkbox"/> Bone <input type="checkbox"/> Flint <input type="checkbox"/> Stone <input type="checkbox"/> Burnt stone <input type="checkbox"/> Glass <input type="checkbox"/> Metal <input type="checkbox"/> CBM <input type="checkbox"/> Wood <input type="checkbox"/> Leather <input type="checkbox"/>		
ΔSmall Finds		Recorder <i>DS</i>
◇Samples		Date <i>4 9 00</i> <i>29 Feb</i>
ΔBuilding Materials		Initials

SITE <i>OLR00</i>	CONTEXT RECORD	Context No. <i>148</i>
Additional Sheets:		Type <i>ledge</i>
Trench	Context Type: Deposit / Cut / Structure	Check Lists:
Site sub-div <i>South chancel</i>	Overlain by:	DEPOSIT: 1.compaction 2.colour 3.composition 4.inclusions 5.thickness 6.extent 7.comments 8.method & conditions
Structure No.	Abutted by:	
Plan No. <i>4</i>	Cut by:	CUT: 1.shape in plan 2.base/sides/top profile 3.dimension and depth 4.sketch 5.truncation 6.fill nos 7.other comments
	Filled by:	
Section No.	Same as:	MASONRY: 1.materials 2.size of bricks etc 3.finish of stones 4.coursing/bond 5.form 6.faces 7.bond 8.dimensions as found 9.other comments
	Part of:	
Co-Ordinates <i>from SE corner of chancel.</i> <i>28m W, 10.7m S</i>	Consists of:	
	Overlies:	
Level	Butts:	
Slide No.	Cuts:	
Neg No.	Fill of:	
Matrix location	Relationships uncertain	
Description (See check lists):		STRATIGRAPHIC MATRIX <div style="text-align: center;"> </div> this context is
<i>1.85m x 0.9m x 0.07m</i>		
Interpretation/Discussion: <i>Stone Ledge</i>		
Finds (tick): None <input type="checkbox"/> Pot <input type="checkbox"/> Bone <input type="checkbox"/> Flint <input type="checkbox"/> Stone <input type="checkbox"/> Burnt stone <input type="checkbox"/> Glass <input type="checkbox"/> Metal <input type="checkbox"/> CBM <input type="checkbox"/> Wood <input type="checkbox"/> Leather <input type="checkbox"/>		
ΔSmall Finds	Recorder <i>DS</i>	
◇Samples	Date <i>4.9.00</i> 27.8.00	
△Building Materials	Initials	

SITE		CONTEXT RECORD		Context No.
OLR00		Additional Sheets:		149
Trench	Context Type: Deposit / Cut / Structure			Check Lists:
Site sub-div <i>South churchyard.</i>	Overlain by:			DEPOSIT: 1.compaction 2.colour 3.composition 4.inclusions 5.thickness 6.extent 7.comments 8.method & conditions
Structure No.	Abutted by:			
Plan No. 4	Cut by:			CUT: 1.shape in plan 2.base/sides/top profile 3.dimension and depth 4.sketch 5.function 6.fill nos 7.other comments
Section No.	Filled by: 158, 187, 188, 189, 190, 191 (Burial)			
Co-Ordinates	Same as:			MASONRY: 1.materials 2.size of bricks etc 3.finish of stones 4.coursing/bond 5.form 6.faces 7.bond 8.dimensions as found 9.other comments
Level	Part of:			
Slide No.	Consists of:			Relationships uncertain
Neg No.	Overlies:			
Matrix location	Butts:			Description (See check lists):
	Cuts:			
	Fill of:			STRATIGRAPHIC MATRIX <pre> graph TD 191[191] --- 149[149] 191 --- B1[] 191 --- B2[] 149 --- B3[] 149 --- B4[] </pre> this context is
Description (See check lists):				
<p>Stone ledge = 10cm thick, bevelled edges, looks similar to top of a table tomb. (see sketch)</p> <p>Bricks = 220 x 62 x 100 mm</p> <p>Light - mid pinkish red / yellowish pink to terracotta.</p> <p>Walls = 25 courses, arch = about 13 courses (broken up by masonry so waswe).</p> <p>Depth of structure = 2.25m</p> <p>Concrete slab over entrance = 0.08m thick, 0.76m wide. 0.85m long.</p>				
Interpretation/Discussion:				
<p>ledge and arched brick grave which contained 6 coffins</p> <p>2 of which are lead. See add sheet for sketch & dimensions</p>				
Finds (tick): None <input type="checkbox"/> Pot <input type="checkbox"/> Bone <input type="checkbox"/> Flint <input type="checkbox"/> Stone <input type="checkbox"/> Burnt stone <input type="checkbox"/> Glass <input type="checkbox"/> Metal <input type="checkbox"/> CBM <input type="checkbox"/> Wood <input type="checkbox"/> Leather <input type="checkbox"/>				
<input type="checkbox"/> Small Finds				Recorder <i>gme.</i>
<input type="checkbox"/> Samples				Date 11-9-00
<input type="checkbox"/> Building Materials				Initials

SITE
02R00

CONTEXT RECORD ADDITIONAL SHEET

Context No.
149

Profile with coffins

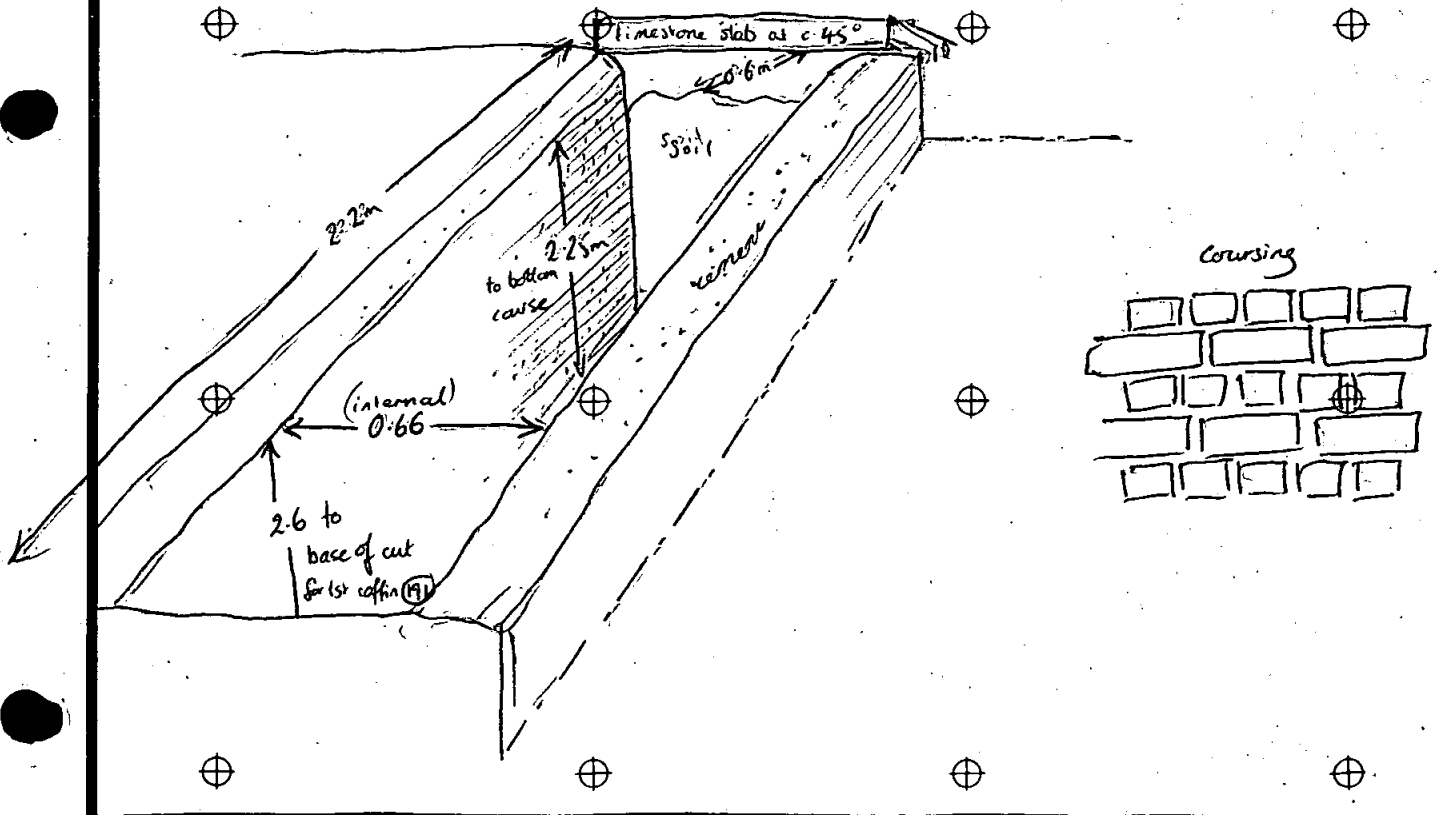
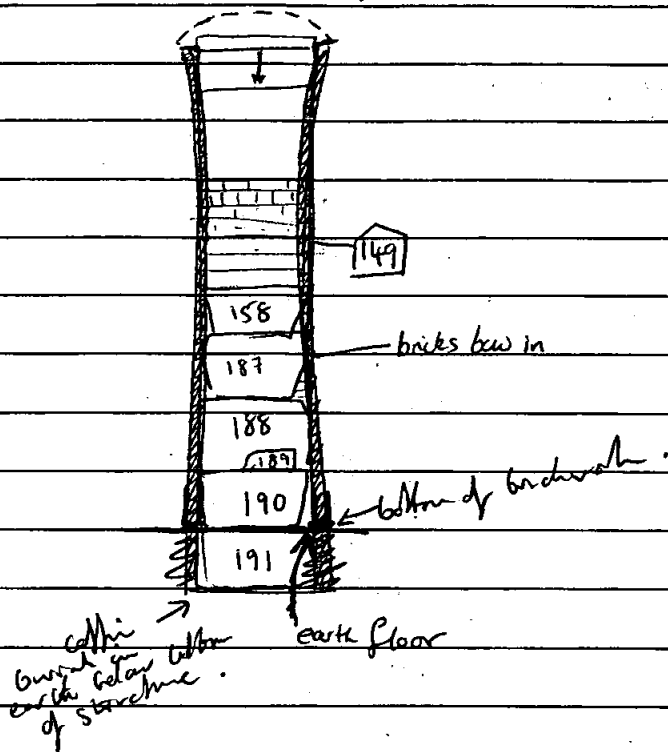

Oxford Archaeological Unit

SITE <i>OLR00</i>	CONTEXT RECORD	Context No. <i>150</i>
Trench	Additional Sheets:	Type <i>ledge</i>
Context Type: <i>Deposit / Cut / Structure</i>	Check Lists:	DEPOSIT:
Site sub-div <i>South churchyard</i>	Overlain by:	1.compaction 2.colour 3.composition 4.inclusions 5.thickness 6.extent 7.comments 8.method & conditions
Structure No.	Abutted by:	
Plan No. <i>A</i>	Cut by:	CUT:
Section No.	Filled by:	
Co-Ordinates <i>from SE corner of church.</i> <i>26m W, 8.5m S</i>	Same as:	1.shape in plan 2.base/sides/top profile 3.dimension and depth 4.sketch 5.truncation 6.fill nos 7.other comments
Level	Part of:	
Slide No.	Consists of:	MASONRY:
Neg No.	Overlies:	
Matrix location	Butts:	1.materials 2.size of bricks etc 3.finish of stones 4.coursing/bond. 5.form 6.faces 7.bond 8.dimensions as found 9.other comments
Description (See check lists):	Cuts:	
Relationships uncertain	Fill of:	
Description (See check lists): <i>1.85m x 0.8m</i>		STRATIGRAPHIC MATRIX
Interpretation/Discussion: <i>Stone Ledge. note Brick Support.</i>		
Finds (tick): None <input type="checkbox"/> Pot <input type="checkbox"/> Bone <input type="checkbox"/> Flint <input type="checkbox"/> Stone <input type="checkbox"/> Burnt stone <input type="checkbox"/> Glass <input type="checkbox"/> Metal <input type="checkbox"/> CBM <input type="checkbox"/> Wood <input type="checkbox"/> Leather <input type="checkbox"/>		
ΔSmall Finds	Recorder <i>DS</i>	
◇Samples	Date <i>4.9.00</i> <i>29.8.00</i>	
ΔBuilding Materials	Initials	

Oxford Archaeological Unit

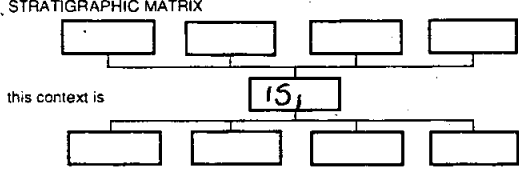
SITE		CONTEXT RECORD		Context No. <i>151</i>
<i>OLR00</i>		Additional Sheets:		Type <i>ledge</i>
Trench	Context Type: <i>Deposit / Cut / Structure</i>			Check Lists:
Site sub-div <i>West Churchyard</i>	Overlain by:	DEPOSIT: 1.compaction 2.colour 3.composition 4.inclusions 5.thickness 6.extent 7.comments 8.method & conditions <hr/> CUT: 1.shape in plan 2.base/sides/top profile 3.dimension and depth 4.sketch 5.truncation 6.fill nos 7.other comments <hr/> MASONRY: 1.materials 2.size of bricks etc 3.finish of stones 4.coursing/bond 5.form 6.faces 7.bond 8.dimensions as found 9.other comments		
Structure No.	Abutted by:			
Plan No. <i>4</i>	Cut by:			
	Filled by:			
Section No.	Same as:			
	Part of:			
Co-Ordinates <i>from SE corner of church</i>	Consists of:			
<i>2.8m W, 7.5m S</i>	Overlies:			
Level	Butts:			
Slide No.	Cuts:			
Neg No.	Fill of:			
Matrix location	Relationships uncertain			
Description (See check lists):		STRATIGRAPHIC MATRIX 		
<i>length at least 1.8m - (W. edge under edge of occ.) x 1.03m wide x 0.08m</i>				
<i>Inscription too worn to decipher.</i>				
Interpretation/Discussion:				
<i>Stone Ledger.</i>				
Finds (tick): None <input type="checkbox"/> Pot <input type="checkbox"/> Bone <input type="checkbox"/> Flint <input type="checkbox"/> Stone <input type="checkbox"/> Burnt stone <input type="checkbox"/> Glass <input type="checkbox"/> Metal <input type="checkbox"/> CBM <input type="checkbox"/> Wood <input type="checkbox"/> Leather <input type="checkbox"/>				
ΔSmall Finds ◇Samples ΔBuilding Materials			Recorder <i>DJ</i> Date <i>4.9.00</i> Initials	

Oxford Archaeological Unit

SITE 0LR00	CONTEXT RECORD	Context No. 152
Trench	Additional Sheets:	Type <i>ledge</i>
Site sub-div <i>South churchyard</i>	Context Type: Deposit / Cut / Structure	Check Lists:
Structure No.	Overlain by:	DEPOSIT: 1.compaction 2.colour 3.composition 4.inclusions 5.thickness 6.extent 7.comments 8.method & conditions
Plan No. A	Abutted by:	
Section No.	Cut by:	CUT: 1.shape in plan 2.base/sides/top profile 3.dimension and depth 4.sketch 5.truncation 6.fill nos 7.other comments
Co-Ordinates <i>from SE corner of church</i> 27W, 6.5m S	Filled by:	
Level	Same as:	MASONRY: 1.materials 2.size of bricks etc 3.finish of stones 4.coursing/bond 5.form 6.faces 7.bond 8.dimensions as found 9.other comments
Slide No.	Part of:	
Neg No.	Consists of:	
Matrix location	Overlies:	
Description (See check lists): 1.81m x 0.9m x 0.1m		Relationships uncertain
STRATIGRAPHIC MATRIX <p style="text-align: center;">this context is</p>		
Interpretation/Discussion: <i>Stone Ledger</i>		
Finds (tick): None <input type="checkbox"/> Pot <input type="checkbox"/> Bone <input type="checkbox"/> Flint <input type="checkbox"/> Stone <input type="checkbox"/> Burnt stone <input type="checkbox"/> Glass <input type="checkbox"/> Metal <input type="checkbox"/> CBM <input type="checkbox"/> Wood <input type="checkbox"/> Leather <input type="checkbox"/>		
ΔSmall Finds	Recorder <i>JS</i>	
◇Samples	Date <i>4 9 00</i> 29 8 00	
ΔBuilding Materials	Initials	

Oxford Archaeological Unit

SITE <i>OLR00</i>		CONTEXT RECORD		Context No. <i>153</i>
Trench		Additional Sheets:		Type <i>Ledger</i>
Context Type: <i>Deposit / Cut / Structure</i>		Check Lists:		DEPOSIT:
Site sub-div <i>South churchyard</i>	Overlain by:	1.compaction 2.colour		
Structure No.	Abutted by:	3.composition		
Plan No. <i>4</i>	Cut by:	4.inclusions 5.thickness		
	Filled by:	6.extent 7.comments		
		8.method & conditions		
Section No.	Same as:	CUT:		
	Part of:	1.shape in plan		
Co-Ordinates <i>from SE corner of church</i>	Consists of:	2.base/sides/top profile		
<i>27m W, 55m S.</i>	Overlies:	3.dimension and depth		
Level	Butts:	4.sketch 5.function		
Slide No.	Cuts:	6.fill nos 7.other comments		
Neg No.	Fill of:	MASONRY:		
Matrix location	Relationships uncertain	1.materials 2.size of bricks etc 3.finish of stones 4.coursing/bond		
Description (See check lists): <i>1.87m x 0.94m x 0.1m</i>		STRATIGRAPHIC MATRIX		
		<pre> graph TD A[] --- B[] B --- C[] C --- D[] D --- E[] E --- F[] F --- G[] G --- H[] H --- I[] I --- J[] J --- K[] K --- L[] L --- M[] M --- N[] N --- O[] O --- P[] P --- Q[] Q --- R[] R --- S[] S --- T[] T --- U[] U --- V[] V --- W[] W --- X[] X --- Y[] Y --- Z[] Z --- AA[] AA --- AB[] AB --- AC[] AC --- AD[] AD --- AE[] AE --- AF[] AF --- AG[] AG --- AH[] AH --- AI[] AI --- AJ[] AJ --- AK[] AK --- AL[] AL --- AM[] AM --- AN[] AN --- AO[] AO --- AP[] AP --- AQ[] AQ --- AR[] AR --- AS[] AS --- AT[] AT --- AU[] AU --- AV[] AV --- AW[] AW --- AX[] AX --- AY[] AY --- AZ[] AZ --- BA[] BA --- BB[] BB --- BC[] BC --- BD[] BD --- BE[] BE --- BF[] BF --- BG[] BG --- BH[] BH --- BI[] BI --- BJ[] BJ --- BK[] BK --- BL[] BL --- BM[] BM --- BN[] BN --- BO[] BO --- BP[] BP --- BQ[] BQ --- BR[] BR --- BS[] BS --- BT[] BT --- BU[] BU --- BV[] BV --- BW[] BW --- BX[] BX --- BY[] BY --- BZ[] BZ --- CA[] CA --- CB[] CB --- CC[] CC --- CD[] CD --- CE[] CE --- CF[] CF --- CG[] CG --- CH[] CH --- CI[] CI --- CJ[] CJ --- CK[] CK --- CL[] CL --- CM[] CM --- CN[] CN --- CO[] CO --- CP[] CP --- CQ[] CQ --- CR[] CR --- CS[] CS --- CT[] CT --- CU[] CU --- CV[] CV --- CW[] CW --- CX[] CX --- CY[] CY --- CZ[] CZ --- DA[] DA --- DB[] DB --- DC[] DC --- DD[] DD --- DE[] DE --- DF[] DF --- DG[] DG --- DH[] DH --- DI[] DI --- DJ[] DJ --- DK[] DK --- DL[] DL --- DM[] DM --- DN[] DN --- DO[] DO --- DP[] DP --- DQ[] DQ --- DR[] DR --- DS[] DS --- DT[] DT --- DU[] DU --- DV[] DV --- DW[] DW --- DX[] DX --- DY[] DY --- DZ[] DZ --- EA[] EA --- EB[] EB --- EC[] EC --- ED[] ED --- EE[] EE --- EF[] EF --- EG[] EG --- EH[] EH --- EI[] EI --- EJ[] EJ --- EK[] EK --- EL[] EL --- EM[] EM --- EN[] EN --- EO[] EO --- EP[] EP --- EQ[] EQ --- ER[] ER --- ES[] ES --- ET[] ET --- EU[] EU --- EV[] EV --- EW[] EW --- EX[] EX --- EY[] EY --- EZ[] EZ --- FA[] FA --- FB[] FB --- FC[] FC --- FD[] FD --- FE[] FE --- FF[] FF --- FG[] FG --- FH[] FH --- FI[] FI --- FJ[] FJ --- FK[] FK --- FL[] FL --- FM[] FM --- FN[] FN --- FO[] FO --- FP[] FP --- FQ[] FQ --- FR[] FR --- FS[] FS --- FT[] FT --- FU[] FU --- FV[] FV --- FW[] FW --- FX[] FX --- FY[] FY --- FZ[] FZ --- GA[] GA --- GB[] GB --- GC[] GC --- GD[] GD --- GE[] GE --- GF[] GF --- GG[] GG --- GH[] GH --- GI[] GI --- GJ[] GJ --- GK[] GK --- GL[] GL --- GM[] GM --- GN[] GN --- GO[] GO --- GP[] GP --- GQ[] GQ --- GR[] GR --- GS[] GS --- GT[] GT --- GU[] GU --- GV[] GV --- GW[] GW --- GX[] GX --- GY[] GY --- GZ[] GZ --- HA[] HA --- HB[] HB --- HC[] HC --- HD[] HD --- HE[] HE --- HF[] HF --- HG[] HG --- HH[] HH --- HI[] HI --- HJ[] HJ --- HK[] HK --- HL[] HL --- HM[] HM --- HN[] HN --- HO[] HO --- HP[] HP --- HQ[] HQ --- HR[] HR --- HS[] HS --- HT[] HT --- HU[] HU --- HV[] HV --- HW[] HW --- HX[] HX --- HY[] HY --- HZ[] HZ --- IA[] IA --- IB[] IB --- IC[] IC --- ID[] ID --- IE[] IE --- IF[] IF --- IG[] IG --- IH[] IH --- II[] II --- IJ[] IJ --- IK[] IK --- IL[] IL --- IM[] IM --- IN[] IN --- IO[] IO --- IP[] IP --- IQ[] IQ --- IR[] IR --- IS[] IS --- IT[] IT --- IU[] IU --- IV[] IV --- IW[] IW --- IX[] IX --- IY[] IY --- IZ[] IZ --- JA[] JA --- JB[] JB --- JC[] JC --- JD[] JD --- JE[] JE --- JF[] JF --- JG[] JG --- JH[] JH --- JI[] JI --- JJ[] JJ --- JK[] JK --- JL[] JL --- JM[] JM --- JN[] JN --- JO[] JO --- JP[] JP --- JQ[] JQ --- JR[] JR --- JS[] JS --- JT[] JT --- JU[] JU --- JV[] JV --- JW[] JW --- JX[] JX --- JY[] JY --- JZ[] JZ --- KA[] KA --- KB[] KB --- KC[] KC --- KD[] KD --- KE[] KE --- KF[] KF --- KG[] KG --- KH[] KH --- KI[] KI --- KJ[] KJ --- KK[] KK --- KL[] KL --- KM[] KM --- KN[] KN --- KO[] KO --- KP[] KP --- KQ[] KQ --- KR[] KR --- KS[] KS --- KT[] KT --- KU[] KU --- KV[] KV --- KW[] KW --- KX[] KX --- KY[] KY --- KZ[] KZ --- LA[] LA --- LB[] LB --- LC[] LC --- LD[] LD --- LE[] LE --- LF[] LF --- LG[] LG --- LH[] LH --- LI[] LI --- LJ[] LJ --- LK[] LK --- LL[] LL --- LM[] LM --- LN[] LN --- LO[] LO --- LP[] LP --- LQ[] LQ --- LR[] LR --- LS[] LS --- LT[] LT --- LU[] LU --- LV[] LV --- LW[] LW --- LX[] LX --- LY[] LY --- LZ[] LZ --- MA[] MA --- MB[] MB --- MC[] MC --- MD[] MD --- ME[] ME --- MF[] MF --- MG[] MG --- MH[] MH --- MI[] MI --- MJ[] MJ --- MK[] MK --- ML[] ML --- MN[] MN --- MO[] MO --- MP[] MP --- MQ[] MQ --- MR[] MR --- MS[] MS --- MT[] MT --- MU[] MU --- MV[] MV --- MW[] MW --- MX[] MX --- MY[] MY --- MZ[] MZ --- NA[] NA --- NB[] NB --- NC[] NC --- ND[] ND --- NE[] NE --- NF[] NF --- NG[] NG --- NH[] NH --- NI[] NI --- NJ[] NJ --- NK[] NK --- NL[] NL --- NM[] NM --- NN[] NN --- NO[] NO --- NP[] NP --- NQ[] NQ --- NR[] NR --- NS[] NS --- NT[] NT --- NU[] NU --- NV[] NV --- NW[] NW --- NX[] NX --- NY[] NY --- NZ[] NZ --- OA[] OA --- OB[] OB --- OC[] OC --- OD[] OD --- OE[] OE --- OF[] OF --- OG[] OG --- OH[] OH --- OI[] OI --- OJ[] OJ --- OK[] OK --- OL[] OL --- OM[] OM --- ON[] ON --- OO[] OO --- OP[] OP --- OQ[] OQ --- OR[] OR --- OS[] OS --- OT[] OT --- OU[] OU --- OV[] OV --- OW[] OW --- OX[] OX --- OY[] OY --- OZ[] OZ --- PA[] PA --- PB[] PB --- PC[] PC --- PD[] PD --- PE[] PE --- PF[] PF --- PG[] PG --- PH[] PH --- PI[] PI --- PJ[] PJ --- PK[] PK --- PL[] PL --- PM[] PM --- PN[] PN --- PO[] PO --- PP[] PP --- PQ[] PQ --- PR[] PR --- PS[] PS --- PT[] PT --- PU[] PU --- PV[] PV --- PW[] PW --- PX[] PX --- PY[] PY --- PZ[] PZ --- QA[] QA --- QB[] QB --- QC[] QC --- QD[] QD --- QE[] QE --- QF[] QF --- QG[] QG --- QH[] QH --- QI[] QI --- QJ[] QJ --- QK[] QK --- QL[] QL --- QM[] QM --- QN[] QN --- QO[] QO --- QP[] QP --- QQ[] QQ --- QR[] QR --- QS[] QS --- QT[] QT --- QU[] QU --- QV[] QV --- QW[] QW --- QX[] QX --- QY[] QY --- QZ[] QZ --- RA[] RA --- RB[] RB --- RC[] RC --- RD[] RD --- RE[] RE --- RF[] RF --- RG[] RG --- RH[] RH --- RI[] RI --- RJ[] RJ --- RK[] RK --- RL[] RL --- RM[] RM --- RN[] RN --- RO[] RO --- RP[] RP --- RQ[] RQ --- RR[] RR --- RS[] RS --- RT[] RT --- RU[] RU --- RV[] RV --- RW[] RW --- RX[] RX --- RY[] RY --- RZ[] RZ --- SA[] SA --- SB[] SB --- SC[] SC --- SD[] SD --- SE[] SE --- SF[] SF --- SG[] SG --- SH[] SH --- SI[] SI --- SJ[] SJ --- SK[] SK --- SL[] SL --- SM[] SM --- SN[] SN --- SO[] SO --- SP[] SP --- SQ[] SQ --- SR[] SR --- SS[] SS --- ST[] ST --- SU[] SU --- SV[] SV --- SW[] SW --- SX[] SX --- SY[] SY --- SZ[] SZ --- TA[] TA --- TB[] TB --- TC[] TC --- TD[] TD --- TE[] TE --- TF[] TF --- TG[] TG --- TH[] TH --- TI[] TI --- TJ[] TJ --- TK[] TK --- TL[] TL --- TM[] TM --- TN[] TN --- TO[] TO --- TP[] TP --- TQ[] TQ --- TR[] TR --- TS[] TS --- TT[] TT --- TU[] TU --- TV[] TV --- TW[] TW --- TX[] TX --- TY[] TY --- TZ[] TZ --- UA[] UA --- UB[] UB --- UC[] UC --- UD[] UD --- UE[] UE --- UF[] UF --- UG[] UG --- UH[] UH --- UI[] UI --- UJ[] UJ --- UK[] UK --- UL[] UL --- UM[] UM --- UN[] UN --- UO[] UO --- UP[] UP --- UQ[] UQ --- UR[] UR --- US[] US --- UT[] UT --- UV[] UV --- UW[] UW --- UX[] UX --- UY[] UY --- UZ[] UZ --- VA[] VA --- VB[] VB --- VC[] VC --- VD[] VD --- VE[] VE --- VF[] VF --- VG[] VG --- VH[] VH --- VI[] VI --- VJ[] VJ --- VK[] VK --- VL[] VL --- VM[] VM --- VN[] VN --- VO[] VO --- VP[] VP --- VQ[] VQ --- VR[] VR --- VS[] VS --- VT[] VT --- VU[] VU --- VV[] VV --- VW[] VW --- VX[] VX --- VY[] VY --- VZ[] VZ --- WA[] WA --- WB[] WB --- WC[] WC --- WD[] WD --- WE[] WE --- WF[] WF --- WG[] WG --- WH[] WH --- WI[] WI --- WJ[] WJ --- WK[] WK --- WL[] WL --- WM[] WM --- WN[] WN --- WO[] WO --- WP[] WP --- WQ[] WQ --- WR[] WR --- WS[] WS --- WT[] WT --- WU[] WU --- WV[] WV --- WW[] WW --- WX[] WX --- WY[] WY --- WZ[] WZ --- XA[] XA --- XB[] XB --- XC[] XC --- XD[] XD --- XE[] XE --- XF[] XF --- XG[] XG --- XH[] XH --- XI[] XI --- XJ[] XJ --- XK[] XK --- XL[] XL --- XM[] XM --- XN[] XN --- XO[] XO --- XP[] XP --- XQ[] XQ --- XR[] XR --- XS[] XS --- XT[] XT --- XU[] XU --- XV[] XV --- XW[] XW --- XX[] XX --- XY[] XY --- XZ[] XZ --- YA[] YA --- YB[] YB --- YC[] YC --- YD[] YD --- YE[] YE --- YF[] YF --- YG[] YG --- YH[] YH --- YI[] YI --- YJ[] YJ --- YK[] YK --- YL[] YL --- YM[] YM --- YN[] YN --- YO[] YO --- YP[] YP --- YQ[] YQ --- YR[] YR --- YS[] YS --- YT[] YT --- YU[] YU --- YV[] YV --- YW[] YW --- YX[] YX --- YY[] YY --- YZ[] YZ --- ZA[] ZA --- ZB[] ZB --- ZC[] ZC --- ZD[] ZD --- ZE[] ZE --- ZF[] ZF --- ZG[] ZG --- ZH[] ZH --- ZI[] ZI --- ZJ[] ZJ --- ZK[] ZK --- ZL[] ZL --- ZM[] ZM --- ZN[] ZN --- ZO[] ZO --- ZP[] ZP --- ZQ[] ZQ --- ZR[] ZR --- ZS[] ZS --- ZT[] ZT --- ZU[] ZU --- ZV[] ZV --- ZW[] ZW --- ZX[] ZX --- ZY[] ZY --- ZZ[] </pre>		
Interpretation/Discussion: <i>Stone Ledger</i>				
Finds (tick): None <input type="checkbox"/> Pot <input type="checkbox"/> Bone <input type="checkbox"/> Flint <input type="checkbox"/> Stone <input type="checkbox"/> Burnt stone <input type="checkbox"/> Glass <input type="checkbox"/> Metal <input type="checkbox"/> CBM <input type="checkbox"/> Wood <input type="checkbox"/> Leather <input type="checkbox"/>				
△Small Finds			Recorder <i>DS</i>	
◇Samples			Date <i>4 9 00</i>	
△Building Materials			Initials	

Oxford Archaeological Unit

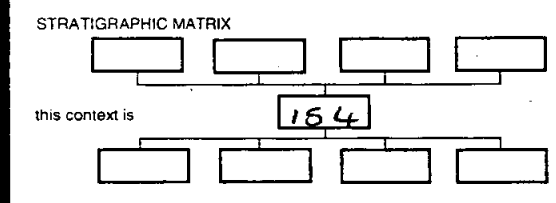
SITE <i>02R00</i>	CONTEXT RECORD		Context No. <i>154</i>
	Additional Sheets:		Type <i>ledge</i>
Trench	Context Type: <i>Deposit / Cut / Structure</i>		Check Lists:
Site sub-div <i>S-C</i>	Overlain by:	DEPOSIT: 1.compaction 2.colour 3.composition 4.inclusions 5.thickness 6.extent 7.comments 8.method & conditions	CUT: 1.shape in plan 2.base/sides/top profile 3.dimension and depth 4.sketch 5.truncation 6.fill nos 7.other comments
Structure No.	Abutted by:		
Plan No.	Cut by:	MASONRY: 1.materials 2.size of bricks etc 3.finish of stones 4.coursing/bond 5.form 6.faces 7.bond 8.dimensions as found 9.other comments	
Section No.	Filled by:		
Co-Ordinates <i>from SE corner of chuce.</i> <i>25m W, 6m S.</i>	Same as:		
	Part of:		
Level	Consists of:		
Slide No.	Overlies:		
Neg No.	Butts:		
Matrix location	Cuts:		
	Fill of:		
	Relationships uncertain		
Description (See check lists): <i>1.86m x 0.85m x 0.09m</i>		STRATIGRAPHIC MATRIX 	
Interpretation/Discussion: <i>Stone Ledge</i>			
Finds (tick): None <input type="checkbox"/> Pot <input type="checkbox"/> Bone <input type="checkbox"/> Flint <input type="checkbox"/> Stone <input type="checkbox"/> Burnt stone <input type="checkbox"/> Glass <input type="checkbox"/> Metal <input type="checkbox"/> CBM <input type="checkbox"/> Wood <input type="checkbox"/> Leather <input type="checkbox"/>			
ΔSmall Finds	Recorder <i>DS</i>		
◇Samples	Date <i>4 9 00</i> 27 8 00		
△Building Materials	Initials		

SITE 0CR00	CONTEXT RECORD	Context No. 155
Trench	Additional Sheets:	Type <i>Reumbart Headstone</i>
Site sub-div	Context Type: Deposit / Cut / Structure	Check Lists:
Structure No.	Overlain by:	DEPOSIT:
Plan No. 4	Abutted by:	1.compaction 2.colour 3.composition 4.inclusions 5.thickness 6.extent 7.comments 8.method & conditions
Section No.	Cut by:	CUT:
Co-Ordinates <i>from SE corner of church</i> 2.5m W, 2.5m S	Filled by:	1.shape in plan 2.base/sides/top profile 3.dimension and depth 4.sketch 5.function 6.fill nos 7.other comments
Level	Same as:	MASONRY:
Slide No.	Part of:	1.materials 2.size of bricks etc 3.finish of stones 4.coursing/bond 5.form 6.faces 7.bond 8.dimensions as found 9.other comments
Neg No.	Consists of:	
Matrix location	Overlies:	
	Butts:	
	Cuts:	
	Fill of:	
	Relationships uncertain	

Description (See check lists):

Slabs

Inscription:

1.9 x 1.0 x 0.01m

To the memory of
Mrs Ana Tudwell
wife of Mr Henry Tudwell
of this parish
who died June 8th 1780
Aged 42 years

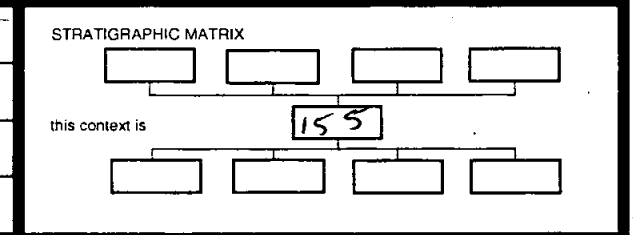

Interpretation/Discussion:

Reumbart Headstone | *Also the Above*
Mr Henry Tudwell
who died Jan^y 5th 1806
Aged 59 years.

Finds (tick): None Pot Bone Flint Stone Burnt stone Glass Metal
 CBM Wood Leather

△Small Finds	Recorder <i>DS</i>
◇Samples	Date <i>4 9 00</i> <i>28 8 00</i>
△Building Materials	Initials

Oxford Archaeological Unit

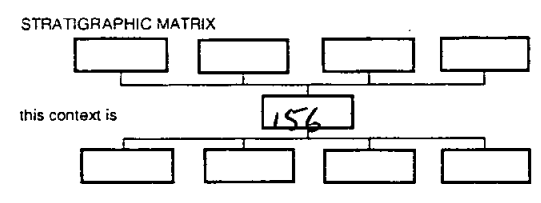
SITE	CONTEXT RECORD	Context No.
OLR00	Additional Sheets:	156
Trench	Context Type: Deposit / Cut / Structure	Type <i>Recurrent Headstone</i>
Site sub-div <i>South chancel</i>	Overlain by:	Check Lists:
Structure No.	Abuted by:	
Plan No. <i>4</i>	Cut by:	DEPOSIT:
	Filled by:	1.compaction 2.colour 3.composition 4.inclusions 5.thickness 6.extent 7.comments 8.method & conditions
Section No.	Same as:	CUT:
	Part of:	1.shape in plan 2.base/sides/top profile 3.dimension and depth 4.sketch 5.truncation 6.fill nos 7.other comments
Co-Ordinates <i>from SE corner of church.</i> <i>12.5m W, 10.5m S</i>	Consists of:	MASONRY:
	Overlies:	1.materials 2.size of bricks etc 3.finish of stones 4.coursing/bond 5.form 6.faces 7.bond 8.dimensions as found 9.other comments
Level	Butts:	
Slide No.	Cuts:	
Neg No.	Fill of:	
Matrix location	Relationships uncertain	
Description (See check lists):		STRATIGRAPHIC MATRIX 
<i>Slabs</i>		
<i>Dimensions = 1.83 x 0.91 x 0.1m</i>		
<i>Inscription.</i>		
<i>Recurrent Headstone?</i>		<i>Secured to the memory of Mr Desford Grant 15 years an inhabitant of this parish eldest son of the Revd Robert Grant Minister of Cullen, North Buteau who died on the 3rd July 1820 Aged 65</i>
Interpretation/Discussion:	Recurrent Headstone?	
	<i>He was a man of the strictest integrity and a sincere friend</i>	
	<i>Also Mrs Elizabeth Mahat?e</i>	
	<i>Sister of the above</i>	
	<i>who departed this life on the 12th day of September 1840 Aged 69</i>	
Finds (tick): None <input type="checkbox"/> Pot <input type="checkbox"/> Bone <input type="checkbox"/> Flint <input type="checkbox"/> Stone <input type="checkbox"/> Burnt stone <input type="checkbox"/> Glass <input type="checkbox"/> Metal <input type="checkbox"/> CBM <input type="checkbox"/> Wood <input type="checkbox"/> Leather <input type="checkbox"/>		
Small Finds		Recorder <i>DS</i>
Samples		Date <i>4 9 00</i> <i>29 8 00</i>
Building Materials		Initials

SITE	CONTEXT RECORD	
0LR00	Context No. 157	
Trench	Additional Sheets:	
Site sub-div. J.C.	Type <i>Stone struct.</i>	
Structure No.	Check Lists:	
Plan No. 4	Context Type: Deposit / Cut / Structure	
Section No.	DEPOSIT:	
Co-Ordinates	1.compaction 2.colour 3.composition 4.inclusions 5.thickness 6.extent 7.comments 8.method & conditions	
Level	CUT:	
Slide No.	1.shape in plan 2.base/sides/top profile 3.dimension and depth 4.sketch 5.truncation 6.fill nos 7.other comments	
Neg No.	MASONRY:	
Matrix location	1.materials 2.size of bricks etc 3.finish of stones 4.coursing/bond 5.form 6.faces 7.bond 8.dimensions as found 9.other comments	
Description (See check lists):	Relationships uncertain	
<p>Stone ledge supports, total structure dimensions = 1.5m⁺ (E side hidden / truncated) 0.9m wide x 0.25m. Individual stones = 0.15m wide x 0.7m long</p>	STRATIGRAPHIC MATRIX	
	Interpretation/Discussion:	
	Stone ledge supports.	
	<p>Finds (tick): None <input type="checkbox"/> Pot <input type="checkbox"/> Bone <input type="checkbox"/> Flint <input type="checkbox"/> Stone <input type="checkbox"/> Burnt stone <input type="checkbox"/> Glass <input type="checkbox"/> Metal <input type="checkbox"/> CBM <input type="checkbox"/> Wood <input type="checkbox"/> Leather <input type="checkbox"/></p>	
ΔSmall Finds	Recorder <i>J.S.</i>	
◇Samples	Date <i>4 9 00</i>	
△Building Materials	Initials	

db.

SITE		COFFIN RECORD SHEET		CONTEXT NO.		
OLR 00				158		
Trench:	Additional sheets: YES x 2		Treatment: excavated by hand. - travel + sandstavel in bag.			
Site sub-div: SC	Grave fills					
Plan no: 6	Grave cut:		Finds			
				None		
Section no: -	Skeleton: 158		Breastplate ✓ delayed + illegible			
				Grip ✓		
Co-ordinates: 28m West 10m South of church wall	Matrix location:		Hinge			
				Bracket		
Levels	Preservation: Wood well preserved		Fixing nails ✓			
				Shroud pins		
Slide No.	Neg No:		Fabric yellow fabric on exterior of coffin attached with studs			
				Other finds		

Description Wooden coffin covered with yellow fabric lined or with ~~brass~~ in alloy studs
 Skeleton fragmentary - calcified / crystalline, some save-able frags. retained.
 some maggot crystallid's waste. Coffin packed with sawdust

Discussion
 Uppermost coffin within brick lined grave / vault 1149. Overlying 187 coffin

Shape, dimensions and distinguishing characteristics

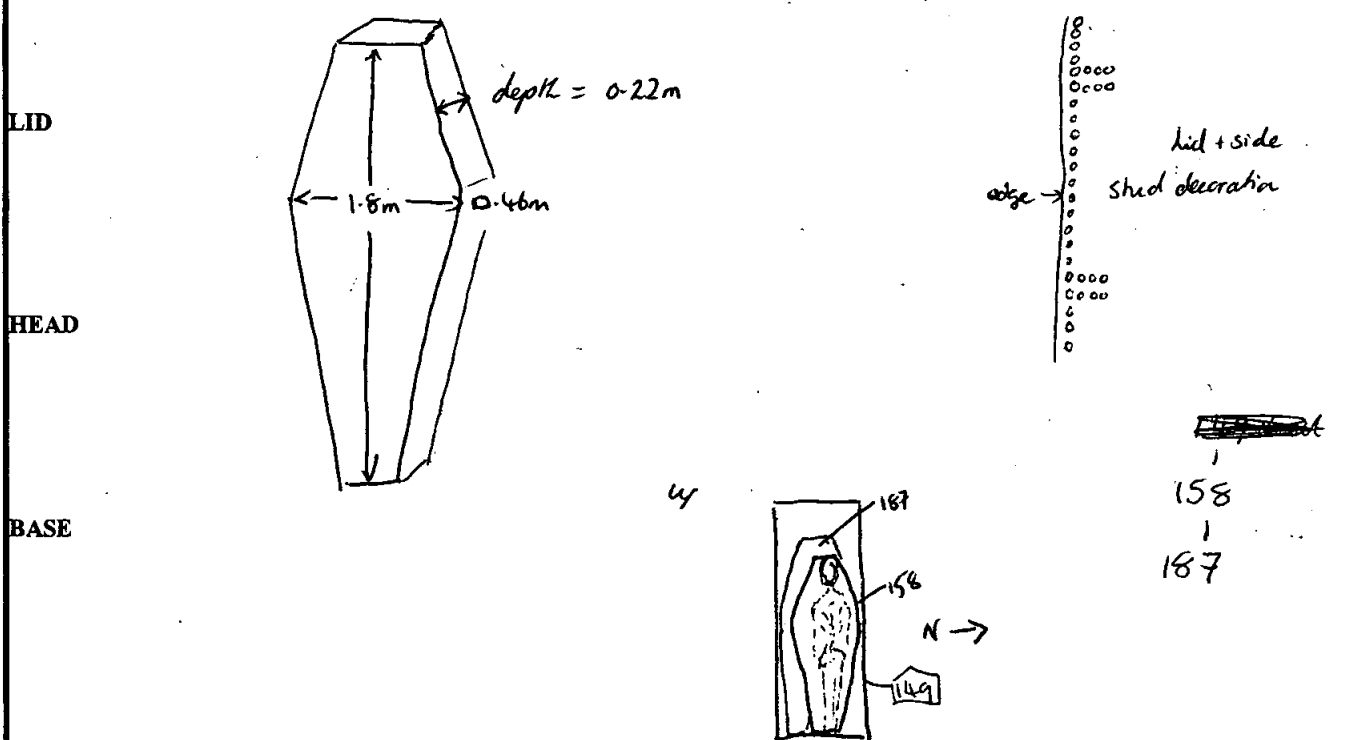

Recorder: S Lewis	Date: 7. 9. 2000	Initials:
-------------------	------------------	-----------

Coffin Recording Sheet

Site Code

Context

02R00

158

Outer Coffin

Sample Ret.

Recording Date 12/10

Associated Numbers

Condition

Dep. Plate

Legible *fe. frags.*

Inscription

top & bottom design over leaf, rest too fragmentary to recognise

Fabric lead ormolou brass tin plated pewter gilt tin
 iron silvered tin enamelled other Sample Ret.

Shape of dep. plate

square rectangle shield tapered lozenge
 cartouche oval other

Upholstery

colour shoddy velvet other *beize* Sample Ret.

Construction

butt joint mitred pitched other

Grip plate Fabric = ormolou brass tin plated pewter gilt tin
 iron silvered tin enamelled other Sample Ret.

Grip Fabric = ormolou brass iron *2* Sample Ret.

see following sheets

Design swag of rose horseshoe cherub's head plain

other

Grip bolts Corner bolts Type = gilt brass brass iron

other Sample Ret.

Lid motifs other Sample Ret.

Escutcheons other Sample Ret.

Upholstery ~~nails~~ *studs* brass gilt brass silvered brass iron enamelled

other *0000* Sample Ret.

Fixings panel nails screws hinges lace Sample Ret.

Timber type Sample Ret.

Interpretation / Comments

.....

db-

SITE <i>OLR00</i>		COFFIN RECORD SHEET	CONTEXT NO. <i>159</i>
Trench:	Additional sheets:	Treatment: <i>Bones collected</i>	
Site sub-div: <i>NC</i>	Grave fills		
Plan no: <i>3</i>	Grave cut:	Finds None	
Section no: <i>-</i>	Skeleton:	Breastplate Grip	
Co-ordinates:	Matrix location:	Hinge Bracket	
Levels	Preservation:	Fixing nails Shroud pins	
Slide No.	Neg No:	Fabric Other finds	
Description <i>Burial</i>			
Discussion			
Shape, dimensions and distinguishing characteristics			
LID			
HEAD			
BASE			
Recorder:	Date:	Initials:	

Coffin Recording Sheet

Site Code

Context

0200

159

Outer Coffin

Sample Ret.

Recording Date 11/10

Associated Numbers

Condition

Dep. Plate

Legible

Inscription

- | | | | | |
|--------------------------------------|---------------------------------------|------------------------------------|--|--------------------------------------|
| Fabric lead <input type="checkbox"/> | ormolou <input type="checkbox"/> | brass <input type="checkbox"/> | tin plated pewter <input type="checkbox"/> | gilt tin <input type="checkbox"/> |
| iron <input type="checkbox"/> | silvered tin <input type="checkbox"/> | enamelled <input type="checkbox"/> | other | Sample Ret. <input type="checkbox"/> |

Shape of dep. plate

- | | | | | |
|------------------------------------|------------------------------------|---------------------------------|----------------------------------|----------------------------------|
| square <input type="checkbox"/> | rectangle <input type="checkbox"/> | shield <input type="checkbox"/> | tapered <input type="checkbox"/> | lozenge <input type="checkbox"/> |
| cartouche <input type="checkbox"/> | oval <input type="checkbox"/> | other | | |

Upholstery

- | | | | | |
|--------------|---------------------------------|---------------------------------|-------------|--------------------------------------|
| colour | shoddy <input type="checkbox"/> | velvet <input type="checkbox"/> | other | Sample Ret. <input type="checkbox"/> |
|--------------|---------------------------------|---------------------------------|-------------|--------------------------------------|

Construction

- | | | | |
|-------------------------------------|---------------------------------|----------------------------------|-------------|
| butt joint <input type="checkbox"/> | mitred <input type="checkbox"/> | pitched <input type="checkbox"/> | other |
|-------------------------------------|---------------------------------|----------------------------------|-------------|

- | | | | | |
|--|---|------------------------------------|--|--------------------------------------|
| Grip plate <input checked="" type="checkbox"/> | Fabric = ormolou <input type="checkbox"/> | brass <input type="checkbox"/> | tin plated pewter <input type="checkbox"/> | gilt tin <input type="checkbox"/> |
| iron <input checked="" type="checkbox"/> | silvered tin <input type="checkbox"/> | enamelled <input type="checkbox"/> | other | Sample Ret. <input type="checkbox"/> |

*disc. frags on rev. **

- | | | | | |
|--|---|--------------------------------|--|--------------------------------------|
| Grip <input checked="" type="checkbox"/> | Fabric = ormolou <input type="checkbox"/> | brass <input type="checkbox"/> | iron <input checked="" type="checkbox"/> <i>x2</i> | Sample Ret. <input type="checkbox"/> |
|--|---|--------------------------------|--|--------------------------------------|

intent ← → = 0.09 ↓ = 0.05

- | | | | | |
|-------------|---------------------------------------|------------------------------------|--|--------------------------------|
| Design | swag of rose <input type="checkbox"/> | horseshoe <input type="checkbox"/> | cherub's head <input type="checkbox"/> | plain <input type="checkbox"/> |
| other | | | | |

- | | | | | |
|-------------------------------------|---------------------------------------|--|--------------------------------|--------------------------------------|
| Grip bolts <input type="checkbox"/> | Corner bolts <input type="checkbox"/> | Type = gilt brass <input type="checkbox"/> | brass <input type="checkbox"/> | iron <input type="checkbox"/> |
| other | | | | Sample Ret. <input type="checkbox"/> |

- | | | | |
|------------|--------------------------|-------------|--------------------------------------|
| Lid motifs | <input type="checkbox"/> | other | Sample Ret. <input type="checkbox"/> |
|------------|--------------------------|-------------|--------------------------------------|

- | | | | |
|-------------|--------------------------|-------------|--------------------------------------|
| Escutcheons | <input type="checkbox"/> | other | Sample Ret. <input type="checkbox"/> |
|-------------|--------------------------|-------------|--------------------------------------|

- | | | | | | |
|--|--------------------------------|-------------------------------------|---|--|--------------------------------------|
| Upholstery nails <input type="checkbox"/> | brass <input type="checkbox"/> | gilt brass <input type="checkbox"/> | silvered brass <input type="checkbox"/> | iron <input checked="" type="checkbox"/> <i>x2</i> | enamelled <input type="checkbox"/> |
| other <i>1 x 000 = 6 studs in total + 1 x 000</i> | | | | <i>x2 pieces</i> | Sample Ret. <input type="checkbox"/> |

- | | | | | | | |
|---------|--------------------------|--------------------------------------|---------------------------------|---------------------------------|-------------------------------|--------------------------------------|
| Fixings | <input type="checkbox"/> | panel nails <input type="checkbox"/> | screws <input type="checkbox"/> | hinges <input type="checkbox"/> | lace <input type="checkbox"/> | Sample Ret. <input type="checkbox"/> |
|---------|--------------------------|--------------------------------------|---------------------------------|---------------------------------|-------------------------------|--------------------------------------|

- | | | |
|-------------|-------|--------------------------------------|
| Timber type | | Sample Ret. <input type="checkbox"/> |
|-------------|-------|--------------------------------------|

*



(Velvet from Rev.)

Interpretation / Comments

.....

.....

db.

SITE <i>OLR00</i>	COFFIN RECORD SHEET	CONTEXT NO. <i>160</i>
Trench:	Additional sheets:	Treatment: <i>Bones collected</i>
Site sub-div: <i>NC</i>	Grave fills	
Plan no: <i>3</i>	Grave cut:	Finds None
Section no:	Skeleton:	Breastplate Grip
Co-ordinates:	Matrix location:	Hinge Bracket
Levels	Preservation:	Fixing nails Shroud pins
Slide No.	Neg No:	Fabric Other finds
Description <i>Burial</i>		
Discussion		
Shape, dimensions and distinguishing characteristics		
LID		
HEAD		
BASE		
Recorder:	Date:	Initials:

Coffin Recording Sheet

Site Code

Context

Outer Coffin

Sample Ret.

Ohloo

160

Recording Date 12/10

Associated Numbers

Condition

Dep. Plate

Legible

Inscription

Fabric lead ormolou brass tin plated pewter gilt tin
 iron silvered tin enamelled other Sample Ret.

Shape of dep. plate

square rectangle shield tapered lozenge
 cartouche oval other

Upholstery

colour shoddy velvet other *Hessian-type (code)* Sample Ret.

Construction

butt joint mitred pitched other

Grip plate Fabric = ormolou brass tin plated pewter gilt tin
 iron silvered tin enamelled other Sample Ret.

Grip Fabric = ormolou brass iron x 1 Sample Ret.

Design swag of rose horseshoe cherub's head ① plain

Grip bolts **Corner bolts** Type = gilt brass brass iron
 other Sample Ret.

Lid motifs other Sample Ret.

Escutcheons other Sample Ret.

Upholstery *studs* brass *x 1 piece* gilt brass silvered brass iron enamelled
 other *30 studs in total* Sample Ret.

Fixings panel nails screws hinges lace Sample Ret.

Timber type Sample Ret.

Interpretation / Comments

.....

db.

SITE		COFFIN RECORD SHEET		CONTEXT NO.	
OLR00				161	
Trench: NC 109		Additional sheets: YES x1		Treatment: Lead coffin no collection	
Site sub-div: NC		Grave fills			
Plan no: 3		Grave cut:		Finds	
				None	
Section no:		Skeleton:		Breastplate	
				Grip	
Co-ordinates:		Matrix location: Vault 109 under 117		Hinge	
				Bracket	
Levels		Preservation: Burial powder!		Fixing nails	
				Shroud pins	
Slide No.		Neg No:		Fabric	
				Other finds	
				:	
Description					
Pb coffin 1.90 x 0.55 x 0.40 m + lead plate. outer wood - shds/material, plate					
Discussion					
Burial → wrapped in well preserved linen shroud, pleated down front. But bones powdered when lifted so not kept for images.					
Shape, dimensions and distinguishing characteristics					
LID					
HEAD					
BASE					
Recorder:		Date:		Initials:	

Coffin Recording Sheet

Site Code

Context

02R00

161

Outer Coffin

Sample Ret.

Recording Date 19/10

Associated Numbers

see film 27/
10-11.

Condition

Dep. Plate

Legible

Inscription

"Edmund Son of Samuel & Mary Roberts / Died 10th Feb 1814 / Aged 17 Years"

Fabric lead

GILDED.

ormolou

brass

tin plated pewter

gilt tin

iron

silvered tin

enamelled

other

Sample Ret.

Shape of dep. plate

square

rectangle

shield

tapered

lozenge

cartouche

oval

other

= (82) which is rect: but this is a tapered version.

Upholstery

colour

shoddy

velvet

other

Sample Ret.

Construction

butt joint

mitred

pitched

other

Grip plate

Fabric = ormolou

brass

tin plated pewter

gilt tin

iron

silvered tin

enamelled

other

Sample Ret.

Grip

Fabric = ormolou

brass

iron

Sample Ret.

Design

swag of rose

horseshoe

cherub's head x1 (4)

plain

other

Grip bolts

Corner bolts

Type = gilt brass

brass

iron

other Sample Ret.

Lid motifs

other Sample Ret.

Escutcheons

other Sample Ret.

Upholstery nails

brass

gilt brass

silvered brass

iron

enamelled

other Sample Ret.

Fixings

panel nails

screws

hinges

lace

Sample Ret.

Timber type

Sample Ret.

Interpretation / Comments

.....
.....

db.

SITE	COFFIN RECORD SHEET	CONTEXT NO.
OLR00		162
Trench: 109	Additional sheets: YES x2.	Treatment: DNA & bones collected
Site sub-div: NU	Grave fills: /	
Plan no: 3	Grave cut: /	Finds: None
Section no:	Skeleton: 162	Breastplate: Grip
Co-ordinates:	Matrix location: Vault 109 under 119	Hinge: Bracket
Levels:	Preservation:	Fixing nails: Shroud pins
Slide No.:	Neg No.:	Fabric: Other finds:

Description lead coffin with skeleton
 16 coffin c. 1.80m long - badly crushed

Discussion

Shape, dimensions and distinguishing characteristics

Lead coffin
 presence of textiles: green silk w/ yellow or cream pattern.

LID
 2 pieces: 1 x pleated w/ hem } photos: film 27
 1 x bow } shots 12-13.

HEAD

BASE

could be cremat?



Recorder:	Date:	Initials:
-----------	-------	-----------

Site Code

Context

Outer Coffin

Sample Ret.

OLR00

162

Recording Date 19/10

Associated Numbers

Condition

Dep. Plate

Legible

Inscription "Mr Thomas Brown / Died 28th April / 1828 / In his 80th year ~~of~~"

Fabric lead ormolou brass tin plated pewter gilt tin
 iron silvered tin enamelled other *no match. See following sheet.* Sample Ret.

Shape of dep. plate

square rectangle shield tapered lozenge
 cartouche oval other

Upholstery

colour shoddy velvet other Sample Ret.

Construction

butt joint mitred pitched other

Grip plate

Fabric = ormolou brass tin plated pewter gilt tin

iron silvered tin enamelled other Sample Ret.
Block x3 (3)'s

Grip

Fabric = ormolou brass iron x2 Sample Ret.

Design

swag of rose horseshoe cherub's head (4)'s plain

other

Grip bolts

Corner bolts Type = gilt brass brass iron

other Sample Ret.

Lid motifs

other Sample Ret.

Escutcheons

other Sample Ret.

Upholstery nails

brass gilt brass silvered brass iron enamelled

other Sample Ret.

Fixings

panel nails screws hinges lace Sample Ret.

Timber type

Sample Ret.

Interpretation / Comments

.....

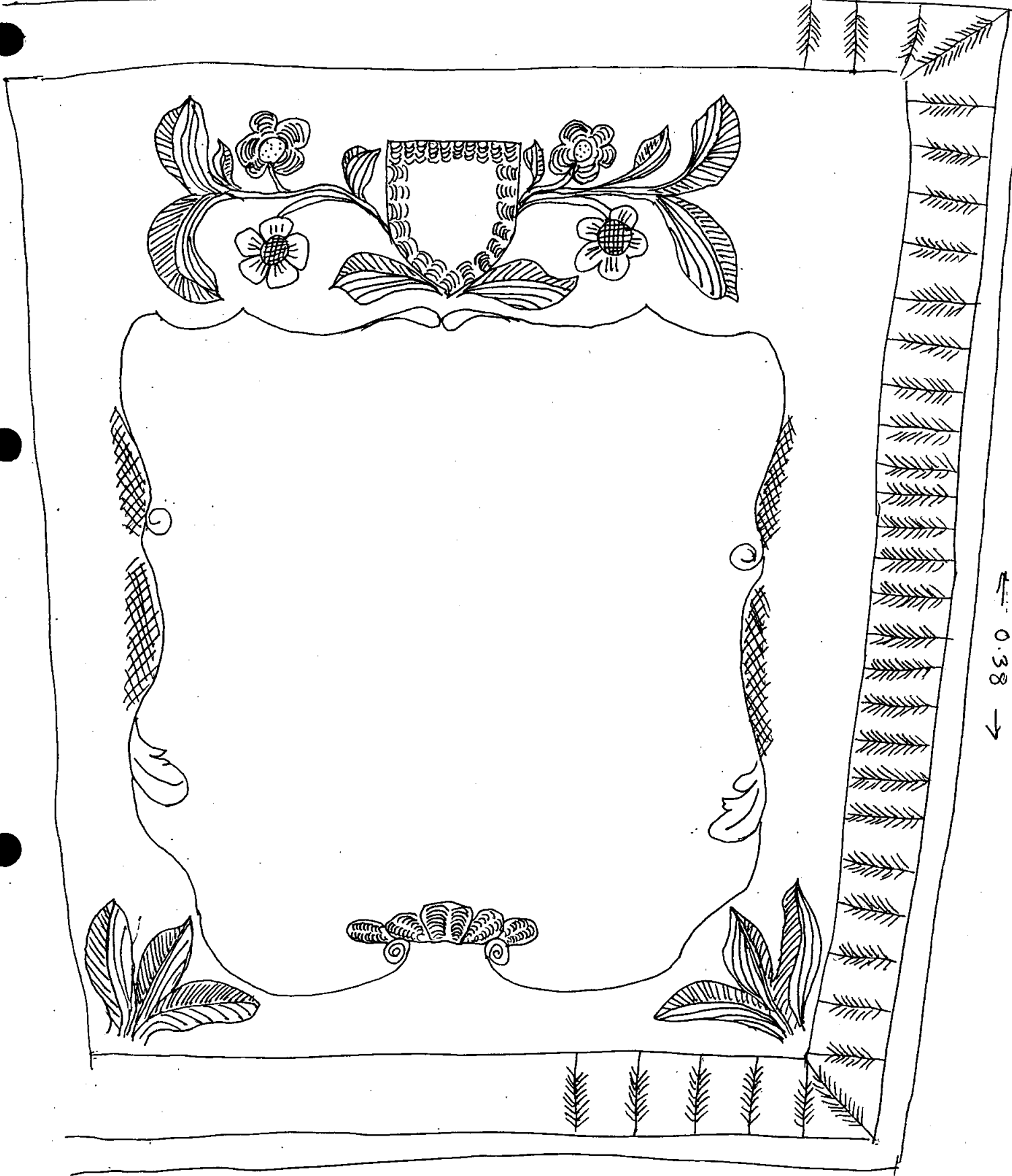

← 0.38 →

← 0.23 →

SITE		COFFIN RECORD SHEET		CONTEXT NO.	
0LR00				163	
Trench:		Additional sheets:		Treatment: <i>Bones collected</i>	
Site sub-div: <i>NU</i>		Grave fills <i>/</i>			
Plan no: <i>3</i>		Grave cut: <i>/</i>		Finds	
Section no: <i>—</i>		Skeleton: <i>163</i>		None	
Co-ordinates:		Matrix location:		Breastplate	
Levels		Preservation: <i>Small / Neo-natal? bones no coffin remains</i>		Grip	
Slide No.		Neg No:		Hinge	
				Bracket	
				Fixing nails	
				Shroud pins	
				Fabric	
				Other finds	
				:	
Description <i>Very Small burial - neo-natal</i>					
Discussion <i>Baby burial.</i>					
Shape, dimensions and distinguishing characteristics <i>No coffin -</i>					
LID					
HEAD					
BASE					
Recorder: <i>Jme</i>		Date: <i>12. 9. 00</i>		Initials:	

Oxford Archaeological Unit

SITE <i>OLR00</i>	CONTEXT RECORD		Context No. <i>164</i>
	Additional Sheets:		Type <i>ledge</i>
Trench	Context Type: <i>Deposit / Cut / Structure</i>		Check Lists:
Site sub-div. <i>5c</i>	Overlain by:	DEPOSIT: 1.compaction 2.colour 3.composition 4.inclusions 5.thickness 6.extent 7.comments 8.method & conditions CUT: 1.shape in plan 2.base/sides/top profile 3.dimension and depth 4.sketch 5.function 6.fill nos 7.other comments MASONRY: 1.materials 2.size of bricks etc 3.finish of stones 4.coursing/bond 5.form 6.faces 7.bond 8.dimensions as found 9.other comments	
Structure No.	Abutted by:		
Plan No. <i>4</i>	Cut by:		
	Filled by:		
Section No. <i>-</i>	Same as:		
	Part of:		
Co-Ordinates <i>from SE corner of church.</i> <i>2.5m W, 1.75m S</i>	Consists of:		
	Overlies:		
Level	Butts:		
Slide No.	Cuts:		
Neg No.	Fill of:		
Matrix location	Relationships uncertain		

Description (See check lists):

1.8m x 0.88 x 0.1m

Inscription: very worn

John Ho L? -

PT^r 1817 Aged ?

Ann Co ?

Daughter of the

? August 1832 Aged ?

(Sar?) at Elizth ?

Interpretation/Discussion:

Daughter of the ?

Jan 1837 Aged

? ne Sarah

? eby 184?

STRATIGRAPHIC MATRIX

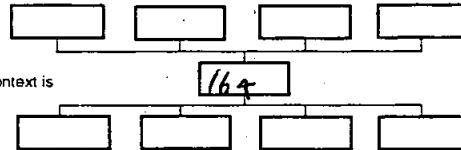

this context is

Finds (tick): None Pot Bone Flint Stone Burnt stone Glass Metal
 CBM Wood Leather

△ Small Finds

Recorder *DS*

◇ Samples

Date *27 4. 200*

△ Building Materials

Initials

Oxford Archaeological Unit

SITE		CONTEXT RECORD		Context No.												
OLR00		Additional Sheets:		165												
Trench		Context Type: Deposit / Cut / Structure		Type <i>ledger</i>												
Site sub-div <i>SC</i>		Overlain by:		Check Lists:												
Structure No.		Abutted by: <i>167</i>		DEPOSIT: 1.compaction 2.colour 3.composition 4.inclusions 5.thickness 6.extent 7.comments 8.method & conditions												
Plan No. <i>4</i>		Cut by:														
Section No.		Filled by:		CUT: 1.shape in plan 2.base/sides/top profile 3.dimension and depth 4.sketch 5.function 6.fill nos 7.other comments												
Co-Ordinates <i>from SE corner of church.</i> <i>19.5m W, 2.5m S</i>		Same as:														
Level		Part of:		MASONRY: 1.materials 2.size of bricks etc 3.finish of stones 4.coursing/bond 5.form 6.faces 7.bond 8.dimensions as found 9.other comments												
Slide No.		Consists of:														
Neg No.		Overlies:														
Matrix location		Butts: <i>167</i>														
		Cuts:														
		Fill of:														
		Relationships uncertain														
Description (See check lists):																
<i>1.67m x 0.75 x 0.09m</i>																
<i>white a curved bit cut out of the North East side</i>																
<div style="display: flex; justify-content: space-between;"> <div style="border: 1px solid black; padding: 5px;"> <p style="margin: 0;"><i>Inscription</i></p> <table border="1" style="margin: 0;"> <tr><td style="text-align: center;"><i>P</i></td></tr> <tr><td style="text-align: center;"><i>1810</i></td></tr> </table> </div> <div style="text-align: center;"> </div> </div>					<i>P</i>	<i>1810</i>										
<i>P</i>																
<i>1810</i>																
<div style="border: 1px solid black; padding: 5px;"> <p style="margin: 0;">STRATIGRAPHIC MATRIX</p> <table style="margin: 0; text-align: center;"> <tr><td style="border: 1px solid black; width: 40px; height: 20px;"></td><td style="border: 1px solid black; width: 40px; height: 20px;"></td><td style="border: 1px solid black; width: 40px; height: 20px;"></td><td style="border: 1px solid black; width: 40px; height: 20px;"></td></tr> <tr><td colspan="4" style="border: none; padding: 5px;">this context is</td></tr> <tr><td style="border: 1px solid black; width: 40px; height: 20px;"></td><td style="border: 1px solid black; width: 40px; height: 20px;"></td><td style="border: 1px solid black; width: 40px; height: 20px;"></td><td style="border: 1px solid black; width: 40px; height: 20px;"></td></tr> </table> </div>									this context is							
this context is																
Interpretation/Discussion:																
<i>Stone ledger</i>																
Finds (tick): None <input type="checkbox"/> Pot <input type="checkbox"/> Bone <input type="checkbox"/> Flint <input type="checkbox"/> Stone <input type="checkbox"/> Burnt stone <input type="checkbox"/> Glass <input type="checkbox"/> Metal <input type="checkbox"/>																
CBM <input type="checkbox"/> Wood <input type="checkbox"/> Leather <input type="checkbox"/>																
ΔSmall Finds				Recorder <i>DS</i>												
◇Samples				Date <i>3.9.00</i>												
△Building Materials				Initials												

SITE		CONTEXT RECORD		Context No. 166
OLR00		Additional Sheets:		Type <i>path</i>
Trench	Context Type: Deposit / Cut / Structure		Check Lists:	
Site sub-div <i>SC</i>	Overlain by:		DEPOSIT:	
Structure No.	Abutted by: <i>see butts / rel. unknown.</i>		1.compaction 2.colour 3.composition 4.inclusions 5.thickness 6.extent 7.comments 8.method & conditions	
Plan No. 4	Cut by:		CUT:	
Section No. -	Filled by:		1.shape in plan 2.base/sides/top profile 3.dimension and depth 4.sketch 5.truncation 6.fill nos 7.other 8.comments	
Co-Ordinates <i>from SE corner of church.</i>	Same as:		MASONRY:	
<i>20 to 25.5m, 0 to 1.5m S</i>	Part of:		1.materials 2.size of bricks etc 3.finish of stones 4.coursing/bond 5.form 6.faces 7.bond 8.dimensions as found 9.other comments	
Level	Consists of:			
Slide No.	Overlies:			
Neg No.	Butts: 164, 167, 167			
Matrix location	Cuts:			
	Fill of:			
	Relationships uncertain			
Description (See check lists):			STRATIGRAPHIC MATRIX	
<i>Glazed paving p</i>				
<i>Paving slabs of roughly 0.5 to 0.8m</i>			this context is	
<i>and about 0.05 to 0.08m thick.</i>				
Interpretation/Discussion:				
<i>Path adjacent to South Wall of Church</i>				
<i>butting ledgers 164 & 167 / on the same level as the ledgers.</i>				
Finds (tick): None <input type="checkbox"/> Pot <input type="checkbox"/> Bone <input type="checkbox"/> Flint <input type="checkbox"/> Stone <input type="checkbox"/> Burnt stone <input type="checkbox"/> Glass <input type="checkbox"/> Metal <input type="checkbox"/>				
CBM <input type="checkbox"/> Wood <input type="checkbox"/> Leather <input type="checkbox"/>				
Δ Small Finds			Recorder <i>DS</i>	
◇ Samples			Date <i>5.9.00</i>	
◻ Building Materials			Initials	

Oxford Archaeological Unit

SITE		CONTEXT RECORD		Context No. <i>167</i>
<i>OLR00</i>		Additional Sheets:		Type <i>ledge</i>
Trench	Context Type: <i>Deposit / Cut / Structure</i>			Check Lists:
Site sub-div <i>SC</i>	Overlain by:			DEPOSIT: 1.compaction 2.colour 3.composition 4.inclusions 5.thickness 6.extent 7.comments 8.method & conditions
Structure No.	Abutted by: <i>166 165</i>			
Plan No. <i>4</i>	Cut by: ↑			CUT: 1.shape in plan 2.base/sides/top profile 3.dimension and depth 4.sketch 5.truncation 6.fill nos 7.other comments
Section No.	Filled by:			
Co-Ordinates <i>from SE corner of church</i> <i>20.5W, 1.25S</i>	Same as:			MASONRY: 1.materials 2.size of bricks etc 3.finish of stones 4.coursing/bond 5.form 6.faces 7.bond 8.dimensions as found 9.other comments
Level	Part of: <i>?</i>			
Slide No.	Consists of:			
Neg No.	Overlies: ↓			
Matrix location	Butts: <i>166 165</i>			
Description (See check lists): <i>2.0m x 1.02m x 0.09m</i>		Cuts:		
		Fill of:		
		Relationships uncertain		
		<p>STRATIGRAPHIC MATRIX</p> <p>this context is</p>		
Interpretation/Discussion: <i>Stone ledge.</i>				
Finds (tick): None <input type="checkbox"/> Pot <input type="checkbox"/> Bone <input type="checkbox"/> Flint <input type="checkbox"/> Stone <input type="checkbox"/> Burnt stone <input type="checkbox"/> Glass <input type="checkbox"/> Metal <input type="checkbox"/> CBM <input type="checkbox"/> Wood <input type="checkbox"/> Leather <input type="checkbox"/>				
ΔSmall Finds				Recorder <i>OS</i>
◇Samples				Date <i>5, 9. 00</i>
△Building Materials				Initials

Oxford Archaeological Unit

SITE <i>OLR 00</i>		CONTEXT RECORD		Context No. <i>168</i>
Trench		Additional Sheets:		Type <i>Gravel</i>
Site sub-div <i>NS</i>	Context Type: <i>Deposit / Cut / Structure</i>	Check Lists:		
Structure No:	Overlain by: <i>184</i>	DEPOSIT:		
Plan No. <i>3</i>	Abutted by:	1.compaction 2.colour 3.composition 4.inclusions 5.thickness 6.extent 7.comments 8.method & conditions		
Section No. <i>7</i>	Cut by:	CUT:		
Co-Ordinates <i>E end of North Side of church</i>	Filled by:	1.shape in plan 2.base/sides/top profile 3.dimension and depth 4.sketch 5.truncation 6.fill nos 7.other comments		
Level	Same as:	MASONRY:		
Slide No.	Part of:	1.materials 2.size of bricks etc 3.finish of stones 4.coursing/bond 5.form 6.faces 7.bond 8.dimensions as found 9.other comments		
Neg No.	Consists of:			
Matrix location	Overlies: <i>171</i>			
	Butts: <i>5</i>			
	Cuts:			
	Fill of:			
	Relationships uncertain			
Description (See check lists): <i>loose</i>		STRATIGRAPHIC MATRIX 		
<i>Gravel of average size 4-6mm</i>				
<i>Thickness up to c. 0.1m</i>				
<i>Extent c. 0.1m 0.6m</i>				
<i>around edges of monument for <i>5</i></i>				
<i>recorded in section</i>				
Interpretation/Discussion: <i>Modern gravel deposit surrounding monument <i>5</i></i>				
Finds (tick): None [<input checked="" type="checkbox"/> Pot [] Bone [] Flint [] Stone [] Burnt stone [] Glass [] Metal [] CBM [] Wood [] Leather []				
Δ Small Finds <input checked="" type="checkbox"/>	Recorder <i>gml</i>			
◇ Samples <input checked="" type="checkbox"/>	Date <i>5.9.00</i>			
△ Building Materials <input checked="" type="checkbox"/>	Initials			

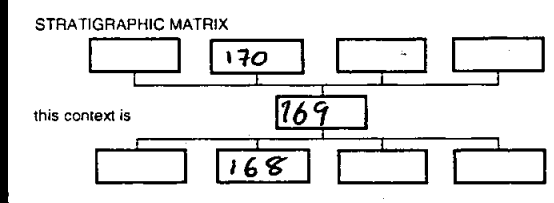
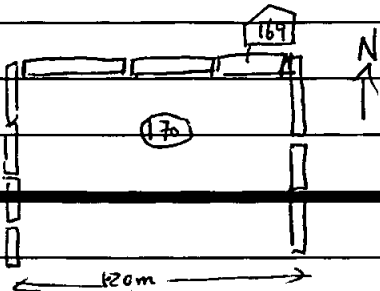
SITE 0LR00	CONTEXT RECORD	Context No. 169
Trench N S	Additional Sheets:	Type <i>Structure</i>
Site sub-div	Context Type: Deposit / Cut / Structure	Check Lists:
Structure No.	Overlain by: /	DEPOSIT: 1.compaction 2.colour 3.composition 4.inclusions 5.thickness 6.extent 7.comments 8.method & conditions
Plan No. 3	Abutted by: (170) Cut by: Filled by:	
Section No. 7	Same as:	CUT: 1.shape in plan 2.base/sides/top profile 3.dimension and depth 4.sketch 5.truncation 6.fill pos 7.other comments
Co-Ordinates	Part of: Consists of:	
Level	Overlies: (183)	MASONRY: 1.materials 2.size of bricks etc 3.finish of stones 4.coursing/bond 5.form 6.faces 7.bond 8.dimensions as found 9.other comments
Slide No.	Butts:	
Neg No.	Cuts:	
Matrix location	Fill of: Relationships uncertain	
Description (See check lists): 1. <i>Limestone edging of modern path</i> <i>60mm wide, 115mm deep,</i> <i>each slab c. 30mm long.</i>		STRATIGRAPHIC MATRIX 
Interpretation/Discussion: 		
<i>Limestone kerb / edging of modern path around church</i>		
Finds (tick): None <input type="checkbox"/> Pot <input type="checkbox"/> Bone <input type="checkbox"/> Flint <input type="checkbox"/> Stone <input type="checkbox"/> Burnt stone <input type="checkbox"/> Glass <input type="checkbox"/> Metal <input type="checkbox"/> CBM <input type="checkbox"/> Wood <input type="checkbox"/> Leather <input type="checkbox"/>		
ΔSmall Finds	Recorder <i>SM</i>	
◇Samples	Date <i>5.9.00</i>	
▽Building Materials	Initials	

Oxford Archaeological Unit

SITE		CONTEXT RECORD		Context No.
OLR00		Additional Sheets:		170
Trench	N-S	Context Type: Deposit / Cut / Structure		Type <i>Deposit</i>
Site sub-div		Overlain by:		Check Lists:
Structure No.		Abutted by:		DEPOSIT:
Plan No.	3	Cut by:		1.compaction 2.colour 3.composition 4.inclusions 5.thickness 6.extent 7.comments 8.method & conditions
Section No.	7	Filled by:		CUT:
		Same as:		
Co-Ordinates		Part of:		MASONRY:
		Consists of:		
Level		Overlies:	168	
Slide No.		Butts:	169	
Neg No.		Cuts:		
Matrix location		Fill of:		
Description (See check lists):		Relationships uncertain		
<p><i>Very compact</i></p> <p><i>light mid grey / yellow</i></p> <p><i>sandy</i></p> <p><i>sand gravel set into tarmac</i></p> <p><i>Thickness = 17mm</i></p> <p><i>Extent = along E. edge of church extending Northwards,</i></p> <p><i>between 1-2m wide, at least 30m long</i></p> <p><i>Machined fl.</i></p>		<p>STRATIGRAPHIC MATRIX</p> <pre> graph TD A[] --- B[] A --- C[] A --- D[] B --- E[] C --- E[] D --- E[] E --- F[] E --- G[] E --- H[] E --- I[] </pre> <p>this context is</p> <p>170</p> <p>169</p>		
Interpretation/Discussion:		<p><i>Modern path surface running N→S along outside of E end of church.</i></p>		
<p>Finds (tick): None [<input checked="" type="checkbox"/>] Pot [<input type="checkbox"/>] Bone [<input type="checkbox"/>] Flint [<input type="checkbox"/>] Stone [<input type="checkbox"/>] Burnt stone [<input type="checkbox"/>] Glass [<input type="checkbox"/>] Metal [<input type="checkbox"/>] CBM [<input type="checkbox"/>] Wood [<input type="checkbox"/>] Leather [<input type="checkbox"/>]</p>				
ΔSmall Finds			Recorder <i>gml</i>	
◇Samples			Date <i>5-9-00</i>	
⊠Building Materials			Initials	

Oxford Archaeological Unit

SITE		CONTEXT RECORD		Context No.
DLR00		Additional Sheets:		171
Trench	NS	Context Type: Deposit / Cut / Structure		Check Lists:
Site sub-div		Overlain by:	(168), (169), (183)	DEPOSIT: 1.compaction 2.colour 3.composition 4.inclusions 5.thickness 6.extent 7.comments 8.method & conditions
Structure No.		Abutted by:		
Plan No.	/	Cut by:		CUT: 1.shape in plan 2.base/sides/top profile 3.dimension and depth 4.sketch 5.truncation 6.fill nos 7.other comments
Section No.	7, 10	Filled by:		
Co-Ordinates		Same as:		MASONRY: 1.materials 2.size of bricks etc 3.finish of stones 4.coursing/bond 5.form 6.faces 7.bond 8.dimensions as found 9.other comments
Level		Part of:		
Slide No.		Consists of:		
Neg No.		Overlies:	(172), (177), (174), (175)	
Matrix location		Butts:		
		Cuts:		
		Fill of:		
		Relationships uncertain		
Description (See check lists):			STRATIGRAPHIC MATRIX	
2. Dark chocolate brown ^{2 Frable}				
3. Sandy silts			this context is	
4. 10-20% stones of approx average 5mm size)				
5. Thickness up to 0.4m				
6. Extent - throughout site				
7.				
8. Mached away				
Interpretation/Discussion:				
General topsoil context for the site				
Finds (tick): None [-] Pot [] Bone [] Flint [] Stone [] Burnt stone [] Glass [] Metal [] CBM [] Wood [] Leather []				
Δ Small Finds			Recorder <i>JMC</i>	
◇ Samples			Date 5. 9. 00	
△ Building Materials			Initials	

Oxford Archaeological Unit

SITE		CONTEXT RECORD		Context No. 172
OLR 00		Additional Sheets:		Type Pipe
Trench NS	Context Type: Deposit / Cut / Structure			Check Lists:
Site sub-div	Overlain by: 171	DEPOSIT: 1.compaction 2.colour 3.composition 4.inclusions 5.thickness 6.extent 7.comments 8.method & conditions		
Structure No.	Abutted by:			
Plan No.	Cut by:	CUT: 1.shape in plan 2.base/sides/top profile 3.dimension and depth 4.sketch 5.truncation 6.fill nos 7.other comments		
	Filled by:			
Section No. 7	Same as:	MASONRY: 1.materials 2.size of bricks etc 3.finish of stones 4.coursing/bond 5.form 6.faces 7.bond 8.dimensions as found 9.other comments		
	Part of:			
Co-Ordinates	Consists of:			
	Overlies:			
Level	Butts:			
Slide No.	Cuts:			
Neg No.	Fill of:			
Matrix location	Relationships uncertain			
Description (See check lists):		STRATIGRAPHIC MATRIX		
		<pre> graph TD A[] --- B[171] A --- C[] A --- D[] B --- E[172] E --- F[] E --- G[171] E --- H[] E --- I[] </pre> <p>this context is</p>		
1 1/4" Iron pipe Redundant				
running N-S on East side of church, takes a 90° turn to W, North of Section 7 & unrenched out by machine.				
Interpretation/Discussion:				
Redundant - Iron service pipe.				
For simplicity, no cut of fill nos allocated with it. Just within topsoil (171).				
Finds (tick): None <input type="checkbox"/> Pot <input type="checkbox"/> Bone <input type="checkbox"/> Flint <input type="checkbox"/> Stone <input type="checkbox"/> Burnt stone <input type="checkbox"/> Glass <input type="checkbox"/> Metal <input type="checkbox"/> CBM <input type="checkbox"/> Wood <input type="checkbox"/> Leather <input type="checkbox"/>				
Δ Small Finds			Recorder <i>SML</i>	
◇ Samples			Date 5 9 00	
◻ Building Materials			Initials	

Oxford Archaeological Unit

SITE		CONTEXT RECORD		Context No. 173
OLR 00		Additional Sheets:		Type <i>Fill</i>
Trench <i>N S.</i>	Context Type: Deposit / Cut / Structure			Check Lists:
Site sub-div	Overlain by: (71) 175	DEPOSIT:		
Structure No.	Abutted by:	1.compaction 2.colour 3.composition 4.inclusions 5.thickness 6.extent 7.comments 8.method & conditions		
Plan No.	Cut by:	CUT:		
	Filled by:	1.shape in plan 2.base/sides/top profile 3.dimension and depth 4.sketch 5.truncation 6.fill nos 7.other comments		
Section No. <i>7</i>	Same as:	MASONRY:		
	Part of:	1.materials 2.size of bricks etc 3.finish of stones 4.coursing/bond 5.form 6.faces 7.bond 8.dimensions as found 9.other comments		
Co-Ordinates	Consists of:			
	Overlies:			
Level	Butts: <i>174</i>			
Slide No.	Cuts:			
Neg No.	Fill of: <i>182</i>			
Matrix location	Relationships uncertain			
Description (See check lists):		STRATIGRAPHIC MATRIX		
1. <i>Fairly loose, friable</i>				
2. <i>mid yellowed brown</i>				
3. <i>loosely sett</i>				
4. <i>Inclusions = >1% charcoal, chalk flecks</i>				
<i>15% stones of av. 5mm size</i>				
<i>Thickness - minimum 0.8m, Extent 0.19m around vault structure 174</i>				
<i>Machined.</i>				
Interpretation/Discussion:				
<i>Backfill of cut for vault (174)</i>				
Finds (tick): None <input type="checkbox"/> Pot <input type="checkbox"/> Bone <input checked="" type="checkbox"/> Flint <input type="checkbox"/> Stone <input type="checkbox"/> Burnt stone <input type="checkbox"/> Glass <input type="checkbox"/> Metal <input type="checkbox"/>				
CBM <input type="checkbox"/> Wood <input type="checkbox"/> Leather <input type="checkbox"/>				
Δ Small Finds				Recorder <i>SM</i>
◇ Samples				Date <i>5.9.00</i>
△ Building Materials				Initials

SITE <i>OLR 00</i>		CONTEXT RECORD		Context No. <i>174</i>
Additional Sheets:		Type & Vault <i>Type & Vault</i>		
Trench <i>NS</i>	Context Type: Deposit / Cut / Structure			Check Lists:
Site sub-div	Overlain by: <i>5</i>	DEPOSIT:		
Structure No.	Abutted by: <i>173</i>	1.compaction 2.colour 3.composition 4.inclusions 5.thickness 6.extent 7.comments 8.method & conditions		
Plan No. <i>3</i>	Cut by:	CUT:		
Section No. <i>7</i>	Filled by:	1.shape in plan 2.base/sides/top profile 3.dimension and depth 4.sketch 5.truncation 6.fill gas 7.other comments		
Co-Ordinates	Same as:	MASONRY:		
Level	Part of:	1.materials 2.size of bricks etc 3.finish of stones 4.coursing/bond 5.form 6.faces 7.bond 8.dimensions as found 9.other comments		
Slide No.	Consists of:			
Neg No.	Overlies:			
Matrix location	Butts:			
	Cuts:			
	Fill of: <i>182</i>			
	Relationships uncertain			

Description (See check lists):
1. Brick vault
Typical bricks = orange/pink with yellowish exterior. 60 x 220 x 100 mm
Max width of structure = 240 cm
length not known.
Limestone slab sealing entrance about 1m wide.
not yet fully exposed. Arched roof
Bond = average 12mm thick, whitish grey sandy mortar

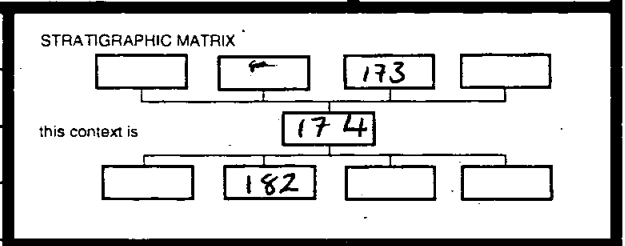

Interpretation/Discussion:
*Brick Vault under monument *5* containing coffin, not yet exc.*

Finds (tick): None <input type="checkbox"/> Pot <input type="checkbox"/> Bone <input type="checkbox"/> Flint <input type="checkbox"/> Stone <input type="checkbox"/> Burnt stone <input type="checkbox"/> Glass <input type="checkbox"/> Metal <input type="checkbox"/> CBM <input type="checkbox"/> Wood <input type="checkbox"/> Leather <input type="checkbox"/>	
ΔSmall Finds	Recorder <i>SM</i>
◇Samples	Date <i>5.9.00</i>
△Building Materials	Initials

Oxford Archaeological Unit

SITE		CONTEXT RECORD		Context No. 175
OLR 00		Additional Sheets:		Type <i>Struct.</i>
Trench N-S.	Context Type: Deposit / Cut / Structure		Check Lists:	
Site sub-div	Overlain by: 171	DEPOSIT: 1.compaction 2.colour 3.composition 4.inclusions 5.thickness 6.extent 7.comments 8.method & conditions		
Structure No.	Abutted by:			
Plan No. 3	Cut by:	CUT: 1.shape in plan 2.base/sides/top profile 3.dimension and depth 4.sketch 5.truncation 6.fill nos 7.other comments		
	Filled by:			
Section No. 7	Same as:	MASONRY: 1.materials 2.size of bricks etc 3.finish of stones 4.coursing/bond 5.form 6.faces 7.bond 8.dimensions as found 9.other comments		
	Part of:			
Co-Ordinates	Consists of:			
	Overlies: 176			
Level	Butts:			
Slide No.	Cuts:			
Neg No.	Fill of: 181			
Matrix location	Relationships uncertain			
Description (See check lists): <i>Brick.</i>		STRATIGRAPHIC MATRIX 		
<i>Orangery red fabric</i>				
<i>Size = 60mm x 110mm x unknown length.</i>				
<i>Bind = greyish white sandy mortar</i>				
<i>3 courses of brick.</i>				
<i>Mortar up to 60mm thick in places, untidy as would have been seen</i>				
Interpretation/Discussion:				
<i>Brick base support for ledge mortaring grave fill (176)</i>				
<i>Visible in section 7 as E end of support with the N & S sides visible & chipped away by machine.</i>				
Finds (tick): None <input type="checkbox"/> Pot <input type="checkbox"/> Bone <input type="checkbox"/> Flint <input type="checkbox"/> Stone <input type="checkbox"/> Burnt stone <input type="checkbox"/> Glass <input type="checkbox"/> Metal <input type="checkbox"/> CBM <input type="checkbox"/> Wood <input type="checkbox"/> Leather <input type="checkbox"/>				
Δ Small Finds	Recorder <i>JML</i>			
◇ Samples	Date <i>5 9 00</i>			
△ Building Materials	Initials			

SITE		CONTEXT RECORD		Context No.
OLR 00				176
Trench: N-S		Additional Sheets:		Type Full
Site sub-div	Context Type: Deposit / Cut / Structure	Check Lists:		
Structure No.	Overlain by: 175	DEPOSIT:		
Plan No.	Abutted by:	1.compaction 2.colour 3.composition 4.inclusions 5.thickness 6.extent 7.comments 8.method & conditions		
Section No. 7	Cut by:	CUT:		
Co-Ordinates	Filled by:	1.shape in plan 2.base/sides/top profile 3.dimension and depth 4.sketch 5.truncation 6.fill nos 7.other comments		
Level	Same as:	MASONRY:		
Slide No.	Part of:	1.materials 2.size of bricks etc 3.finish of stones 4.coursing/bond 5.form 6.faces 7.bond 8.dimensions as found 9.other comments		
Neg No.	Consists of:			
Matrix location	Overlies: Coffin? not yet exc.			
	Butts:			
	Cuts:			
	Fill of: 181			
	Relationships uncertain			
Description (See check lists):		STRATIGRAPHIC MATRIX		
loose		<pre> graph TD 175[175] --- 176[176] 176 --- 181[181] 176 --- B[Burial no. 181] </pre>		
Mid brownish grey				
sandy silt				
Inclusions = 20% stones & c.b.m of				
up to ^{10mm} size				
Thickness - not yet exc. width = 0.58m, length = ?				
Machine exc. down to c. 0.6m so far.				
Interpretation/Discussion:				
Grave backfill				
Finds (tick): None <input type="checkbox"/> Pot <input type="checkbox"/> Bone <input type="checkbox"/> Flint <input type="checkbox"/> Stone <input type="checkbox"/> Burnt stone <input type="checkbox"/> Glass <input type="checkbox"/> Metal <input type="checkbox"/>				
CBM <input type="checkbox"/> Wood <input type="checkbox"/> Leather <input type="checkbox"/>				
Δ Small Finds		Recorder SML		
◇ Samples		Date 5 9 00		
△ Building Materials		Initials		

SITE		CONTEXT RECORD		Context No. 177
OLR 00		Additional Sheets:		Type <i>daye</i>
Trench <i>N-S</i>	Context Type: Deposit / Cut / Structure			Check Lists:
Site sub-div	Overlain by: <i>171</i>	DEPOSIT:		
Structure No.	Abutted by:	1.compaction 2.colour 3.composition 4.inclusions 5.thickness 6.extent 7.comments 8.method & conditions		
Plan No.	Cut by: <i>loads of graves!</i>	CUT:		
Section No. <i>7, 10,</i>	Filled by:	1.shape in plan 2.base/sides/top profile 3.dimenation and depth 4.sketch 5.truncation 6.fill nos 7.other comments		
Co-Ordinates	Same as:	MASONRY:		
Level	Part of:	1.materials 2.size of bricks etc 3.finish of stones 4.coursing/bond 5.form 6.faces 7.bond 8.direpnsions as found 9.other comments		
Slide No.	Consists of:			
Neg No.	Overlies: <i>178 & 179</i>			
Matrix location	Butts:			
	Cuts:			
	Fill of:			
	Relationships uncertain			
Description (See check lists):				STRATIGRAPHIC MATRIX <pre> graph TD 171[171] --- 177[177] 177 --- 178[178] </pre> this context is
<i>1. Fairly loose</i>				
<i>2. And yellow brown</i>				
<i>3. Sandy silt</i>				
<i>4. Inclusions = 5-10% c.b.m up to 25cm size</i>				
<i>20% stones of 1-5 50mm size</i>				
<i>5. Thickness = c. 0.5m</i>				
<i>Extent = throughout soil.</i>				
Interpretation/Discussion:				
<i>Graveyard soil deliberately deposited ^{sometime} after construction of church. overlies a demolition / construction layer 179 presumably related to construction of church and though this layer the graves are cut. Dump of soil to raise churchyard level. & dated prob. 1733-1740</i>				
Finds (tick): None <input type="checkbox"/> Pot <input type="checkbox"/> Bone <input type="checkbox"/> Flint <input type="checkbox"/> Stone <input type="checkbox"/> Burnt stone <input type="checkbox"/> Glass <input type="checkbox"/> Metal <input type="checkbox"/> CBM <input type="checkbox"/> Wood <input type="checkbox"/> Leather <input type="checkbox"/>				
△Small Finds				Recorder <i>SM</i>
◇Samples				Date <i>5 9 00</i>
△Building Materials				Initials

Oxford Archaeological Unit

SITE <i>OLR 00</i>	CONTEXT RECORD		Context No. <i>178</i>
Additional Sheets:		Type <i>layer</i>	
Trench <i>4</i>	Context Type: Deposit / Cut / Structure		Check Lists:
Site sub-div	Overlain by: <i>(177)</i>	DEPOSIT: 1.compaction 2.colour 3.composition 4.inclusions 5.thickness 6.extent 7.comments 8.method & conditions	
Structure No.	Abutted by:		
Plan No. <i>-</i>	Cut by: <i>loads of graves, inc. 1181 & 1182</i>	CUT: 1.shape in plan 2.base/sides/top profile 3.dimension and depth 4.sketch 5.truncation 6.fill nos 7.other comments	
Section No. <i>7</i>	Same as:		
Co-Ordinates	Part of: <i>(179)</i>	MASONRY: 1.materials 2.size of bricks etc 3.finish of stones 4.coursing/bond 5.form 6.faces 7.bond 8.dimensions as found 9.other comments	
Level	Consists of:		
Slide No.	Overlies: <i>(179)</i>		
Neg No.	Butts:		
Matrix location	Cuts:		
	Fill of:		
	Relationships uncertain		
Description (See check lists): <i>Medium compact loose yellowish orange Crushed brick, of fragments averaging 3mm. Thickness = 5 to 16mm Extent = seen in section 7 for only 1m but noted elsewhere on N side of church as graves cutting through it in plan.</i>		<p>STRATIGRAPHIC MATRIX</p> <pre> graph TD A[] --- B[177] A --- C[] A --- D[] B --- E[178] C --- E D --- E E --- F[179] E --- G[] E --- H[] </pre> <p>this context is 178</p>	
Interpretation/Discussion: <i>Layer of crushed brick, part of dump/demolition Layer (179).</i>			
Finds (tick): None <input type="checkbox"/> Pot <input type="checkbox"/> Bone <input type="checkbox"/> Flint <input type="checkbox"/> Stone <input type="checkbox"/> Burnt stone <input type="checkbox"/> Glass <input type="checkbox"/> Metal <input type="checkbox"/> CBM <input type="checkbox"/> Wood <input type="checkbox"/> Leather <input type="checkbox"/>			
Δ Small Finds		Recorder <i>SMC.</i>	
◇ Samples		Date <i>5.9.00</i>	
△ Building Materials		Initials	

SITE	CONTEXT RECORD		Context No. <u>179</u>
<u>OL R00</u>	Additional Sheets:		Type <u>layer</u>
Trench <u>N-S.</u>	Context Type: <u>Deposit / Cut / Structure</u>		Check Lists:
Site sub-div	Overlain by: <u>(178) > (177)</u>		DEPOSIT:
Structure No.	Abutted by:		1.compaction 2.colour
Plan No.	Cut by: <u>loads of gravel inc. [181] & [182]</u>		3.composition
	Filled by:		4.inclusions 5.thickness
Section No. <u>7, 10</u>	Same as:		6.extent 7.comments
Co-Ordinates	Part of:		8.method & conditions
	Consists of:		CUT:
Level	Overlies: <u>(180)</u>		1.shape in plan
Slide No.	Butts:		2.base/sides/top profile
Neg No.	Cuts:		3.dimension and depth
Matrix location	Fill of:		4.sketch 5.truncation
	Relationships uncertain		6.fill nos 7.other comments
Description (See check lists):		STRATIGRAPHIC MATRIX	
<u>loose-medium compact, crumbly.</u>		<pre> graph TD A[] --- B[178] A --- C[] A --- D[] B --- E[179] C --- E D --- E E --- F[180] E --- G[] E --- H[] </pre>	
<u>Mid yellowish grey / white with lenses</u>		this context is	
<u>of mid brownish grey sandy silt</u>			
<u>v. Composed mainly of inclusions of c.b.m</u>			
<u>average size 10mm, and crushed c.b.m and chalk/mortar.</u>			
<u>Thickness = c. 20mm</u>			
<u>Extent - throughout site.</u>			
Interpretation/Discussion:			
<u>General demolition / construction layer associated with</u>			
<u>the construction of the church in 1733. Above this</u>			
<u>the 'churchyard soil' was deposited to raise ground level</u>			
Finds (tick): None <input type="checkbox"/> Pot <input type="checkbox"/> Bone <input type="checkbox"/> Flint <input type="checkbox"/> Stone <input type="checkbox"/> Burnt stone <input type="checkbox"/> Glass <input type="checkbox"/> Metal <input type="checkbox"/> CBM <input type="checkbox"/> Wood <input type="checkbox"/> Leather <input type="checkbox"/>			
△Small Finds			Recorder <u>BML.</u>
◇Samples			Date <u>5. 9. 00</u>
△Building Materials			Initials

SITE		CONTEXT RECORD		Context No. 180
OLR 00		Additional Sheets:		Type <i>layer</i>
Trench N-S.	Context Type: Deposit / Cut / Structure			Check Lists:
Site sub-div	Overlain by: 177	DEPOSIT: 1.compaction 2.colour 3.composition 4.inclusions 5.thickness 6.extent 7.comments 8.method & conditions		
Structure No.	Abutted by:			
Plan No.	Cut by: <i>loads of graves</i>	CUT: 1.shape in plan 2.base/sides/top profile 3.dimension and depth 4.sketch 5.truncation 6.fill nos 7.other comments		
Section No. 7, 10,	Filled by:			
Co-Ordinates	Same as:	MASONRY: 1.materials 2.size of bricks etc 3.finish of stones 4.coursing/bond 5.form 6.faces 7.bond 8.dimensions as found 9.other comments		
Level	Part of:			
Slide No.	Consists of:			
Neg No.	Overlies:			
Matrix location	Butts:			
	Cuts:			
	Fill of:			
	Relationships uncertain			
Description (See check lists):		STRATIGRAPHIC MATRIX		
<i>medium compact</i>		<pre> graph TD A[] --- B[177] B --- C[] B --- D[] B --- E[] C --- F[] C --- G[] C --- H[] C --- I[] </pre>		
<i>mid yellowish brown</i>		this context is		
<i>Sandy silt</i>		<pre> graph TD J[180] --- K[] J --- L[] J --- M[] J --- N[] </pre>		
<i>Inclusions - 10% c.b.m</i>				
<i>Thickness - not yet known</i>				
<i>Extend -</i>				
Interpretation/Discussion:				
<i>level / layer to which machine has excavated as it</i>				
<i>stands on 5. 9. 00. possibly the original ground surface</i>				
<i>from which the church was built. overlain by construction / demol. layer (177)</i>				
Finds (tick): None <input type="checkbox"/> Pot <input type="checkbox"/> Bone <input type="checkbox"/> Flint <input type="checkbox"/> Stone <input type="checkbox"/> Burnt stone <input type="checkbox"/> Glass <input type="checkbox"/> Metal <input type="checkbox"/>				
CBM <input type="checkbox"/> Wood <input type="checkbox"/> Leather <input type="checkbox"/>				
Δ Small Finds				Recorder <i>JML.</i>
◇ Samples				Date <i>5 9 00</i>
△ Building Materials				Initials

SITE		CONTEXT RECORD		Context No. 181
OL R 00		Additional Sheets:		Type Cut
Trench NS	Context Type: Deposit / Cut / Structure		Check Lists:	
Site sub-div	Overlain by:		DEPOSIT:	
Structure No.	Abutted by:		1.compaction 2.colour 3.composition 4.inclusions 5.thickness 6.extent 7.comments 8.method & conditions	
Plan No.	Cut by:		CUT:	
	Filled by: (176), (175)		1.shape in plan 2.base/sides/top profile 3.dimension and depth 4.sketch 5.truncation 6.fill nos 7.other comments	
Section No. 7	Same as:		MASONRY:	
	Part of:		1.materials 2.size of bricks etc 3.finish of stones 4.coursing/bond 5.form 6.faces 7.bond 8.dimensions as found 9.other comments	
Co-Ordinates	Consists of:			
	Overlies:			
Level	Butts:			
Slide No.	Cuts: (177) (178) (179) (180) (173)			
Neg No.	Fill of:			
Matrix location	Relationships uncertain			
Description (See check lists): Grave cut orientated Grave cut orientated E → W, up to 0.6m wide, depth & length n-y.k. Vertical sides,			STRATIGRAPHIC MATRIX 176 [] [] [Coffins?] [] this context is [181] [] [177] [] []	
Filled by (176), capped by (175)				
Interpretation/Discussion: Grave construction cut.				
Finds (tick): None [] Pot [] Bone [] Flint [] Stone [] Burnt stone [] Glass [] Metal [] CBM [] Wood [] Leather []				
Δ Small Finds			Recorder <i>ENC</i>	
◇ Samples			Date 5. 9.00	
△ Building Materials			Initials	

SITE O L R 00	CONTEXT RECORD	Context No. 182
	Additional Sheets:	Type Cut
Trench N-S.	Context Type: Deposit / Cut / Structure	Check Lists:
Site sub-div	Overlain by:	DEPOSIT: 1.compaction 2.colour 3.composition 4.inclusions 5.thickness 6.extent 7.comments 8.method & conditions
Structure No.	Abutted by:	
Plan No.	Cut by:	CUT: 1.shape in plan 2.base/sides/top profile 3.dimension and depth 4.sketch 5.truncation 6.fill nos 7.other comments
	Filled by: 174 & 173	
Section No. 7	Same as:	MASONRY: 1.materials 2.size of bricks etc 3.finish of stones 4.coursing/bond 5.form 6.faces 7.bond 8.dimensions as found 9.other comments
	Part of:	
Co-Ordinates	Consists of:	
	Overlies:	
Level	Butts:	
Slide No.	Cuts:	
Neg No.	Fill of:	
Matrix location	Relationships uncertain	
Description (See check lists):		STRATIGRAPHIC MATRIX <pre> graph TD 174[174] --- 182[182] 177[177] --- 182 style 182 fill:#fff,stroke:#000 style 174 fill:#fff,stroke:#000 style 177 fill:#fff,stroke:#000 </pre>
1. <i>Rectangular cut, N. edge recorded in section.</i>		
2. <i>Sides pretty vertical.</i>		
3. <i>probably c. 2.4m wide, one dimension n-y.k.</i>		
<i>Truncated by [181] grave cut 0.1m North of this one.</i>		
Interpretation/Discussion:		
<i>Cut for vault associated with monument (5)</i>		
Finds (tick): None <input type="checkbox"/> Pot <input type="checkbox"/> Bone <input type="checkbox"/> Flint <input type="checkbox"/> Stone <input type="checkbox"/> Burnt stone <input type="checkbox"/> Glass <input type="checkbox"/> Metal <input type="checkbox"/> CBM <input type="checkbox"/> Wood <input type="checkbox"/> Leather <input type="checkbox"/>		
△Small Finds	Recorder <i>JML</i>	
◇Samples	Date <i>5.9.00</i>	
△Building Materials	Initials	

Oxford Archaeological Unit

SITE		CONTEXT RECORD		Context No.
OLR00		Additional Sheets:		183
Trench	N-S	Context Type: Deposit / Cut / Structure		Type Layer
Site sub-div		Overlain by:	(170)	Check Lists:
Structure No.		Abutted by:		DEPOSIT:
Plan No.		Cut by:		1.compaction 2.colour 3.composition 4.inclusions 5.thickness 6.extent 7.comments 8.method & conditions
Section No.	7	Filled by:		CUT:
Co-Ordinates		Same as:		1.shape in plan 2.base/sides/top profile 3.dimension and depth 4.sketch 5.truncation 6.fill nos 7.other comments
Level		Part of:		MASONRY:
Slide No.		Consists of:		1.materials 2.size of bricks etc 3.finish of stones 4.coursing/bond 5.form 6.faces 7.bond 8.dimensions as found 9.other comments
Neg No.		Overlies:	(171)	
Matrix location		Butts:	[5] x [16.9]	
Description (See check lists):		Cuts:		
Top 65mm very compact, lower 120mm loose sand		Fill of:		
Light whitish yellow sand & cement		Relationships uncertain		
Gravel inclusions = 40%.				
Thickness in total = 185mm.				
Extent = c. 1.5m wide, length = c. 30m along E end of exterior of church. Machined off on N. side side of church.				
Interpretation/Discussion:				
sand cement base for church path.				
Finds (tick): None <input type="checkbox"/> Pot <input type="checkbox"/> Bone <input type="checkbox"/> Flint <input type="checkbox"/> Stone <input type="checkbox"/> Burnt stone <input type="checkbox"/> Glass <input type="checkbox"/> Metal <input type="checkbox"/> CBM <input type="checkbox"/> Wood <input type="checkbox"/> Leather <input type="checkbox"/>				
ΔSmall Finds				Recorder <i>SM</i> .
◇Samples				Date 5. 9. 00
△Building Materials				Initials

STRATIGRAPHIC MATRIX

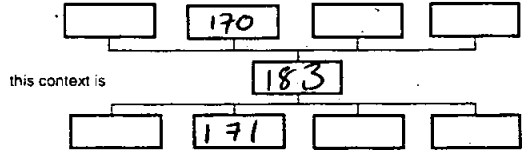

SITE		CONTEXT RECORD		Context No.
OL R00		Additional Sheets:		184
Trench	NS	Context Type: Deposit / Cut / Structure		Type Structure
Site sub-div		Overlain by: /		Check Lists:
Structure No.		Abutted by:		DEPOSIT:
Plan No.	3	Cut by:		1.compaction 2.colour 3.composition 4.inclusions 5.thickness 6.extent 7.comments 8.method & conditions
Section No.	7	Filled by:		CUT:
Co-Ordinates		Same as: 101		1.shape in plan 2.base/side/top profile 3.dimension and depth 4.sketch 5.truncation 6.fill nos 7.other comments
Level		Part of: 101		MASONRY:
Slide No.		Consists of:		1.materials 2.size of bricks etc 3.finish of stones 4.coursing/bond 5.form 6.faces 7.bond 8.dimensions as found 9.other comments
Neg No.		Overlies: 168		
Matrix location		Butts:		
		Cuts:		
		Fill of:		
		Relationships uncertain		
Description (See check lists):			STRATIGRAPHIC MATRIX	
1. Kerb stones measuring an average 300 x 140 x 270 mm size.			<pre> graph TD A[] --- B[] A --- C[] A --- D[] B --- E[] C --- E[] D --- E[] E --- F[] E --- G[] E --- H[] F --- I[] G --- I[] H --- I[] I --- J[] I --- K[] I --- L[] style A fill:none,stroke:none style B fill:none,stroke:none style C fill:none,stroke:none style D fill:none,stroke:none style E fill:none,stroke:none style F fill:none,stroke:none style G fill:none,stroke:none style H fill:none,stroke:none style I fill:none,stroke:none style J fill:none,stroke:none style K fill:none,stroke:none style L fill:none,stroke:none </pre> <p>this context is 184</p>	
6 ^{sq} faces neatly squared off / flat sided, and roughly oblong in shape.				
Interpretation/Discussion:				
Dump of granite block kerb stones ^{that were} forming a path edge that were recorded as 101. observed in this particular area in section 7 not recorded as 184. Bottom layer are in-situ, the upper courses just placed here within the last few weeks.				
Finds (tick): None <input type="checkbox"/> Pot <input type="checkbox"/> Bone <input type="checkbox"/> Flint <input type="checkbox"/> Stone <input type="checkbox"/> Burnt stone <input type="checkbox"/> Glass <input type="checkbox"/> Metal <input type="checkbox"/> CBM <input type="checkbox"/> Wood <input type="checkbox"/> Leather <input type="checkbox"/>				
Δ Small Finds			Recorder <i>SMC</i>	
◇ Samples			Date 5.9.00	
△ Building Materials			Initials	

db.

SITE 0LR00	COFFIN RECORD SHEET	CONTEXT NO. 185
Trench:	Additional sheets: <i>4/15/1</i>	Treatment: <i>bones collected</i>
Site sub-div:	Grave fills /	
Plan no: 3	Grave cut: /	Finds None
Section no:	Skeleton:	Breastplate Grip
Co-ordinates:	Matrix location:	Hinge Bracket
Levels	Preservation:	Fixing nails Shroud pins
Slide No.	Neg No:	Fabric Other finds
Description <i>Burial Will</i> (186) Discussion		
Shape, dimensions and distinguishing characteristics LID HEAD BASE		
Recorder:	Date:	Initials:

db

Coffin Recording Sheet

Site Code

Context

Outer Coffin

Sample Ret.

Recording Date *11/10*

Associated Numbers

Condition

Dep. Plate

Legible

Inscription

Fabric lead ormolou brass tin plated pewter gilt tin
 iron silvered tin enamelled other Sample Ret.

Shape of dep. plate

square rectangle shield tapered lozenge
 cartouche oval other

Upholstery

colour shoddy velvet other Sample Ret.

Construction

butt joint mitred pitched other

Grip plate Fabric = ormolou brass tin plated pewter gilt tin
 iron silvered tin enamelled other Sample Ret.

Grip Fabric = ormolou brass iron Sample Ret.

Design swag of rose horseshoe cherub's head plain

Grip bolts Corner bolts Type = gilt brass brass iron

Lid motifs other Sample Ret.

Escutcheons other Sample Ret.

Upholstery *studs* nails brass gilt brass silvered brass iron *x 3 pieces* enamelled

Fixings panel nails screws hinges lace Sample Ret.

Timber type Sample Ret.

Interpretation / Comments

.....
.....

*x 2 intent O's ← 0.08
↓ 0.04*

1x ~~0000000000~~ 1x 000 1x 00 = 15 studs.

db

SITE 0LR00	COFFIN RECORD SHEET	CONTEXT NO. 186
Trench:	Additional sheets:	Treatment: <i>bones collected</i>
Site sub-div:	Grave fills	
Plan no: 3	Grave cut:	Finds None
Section no:	Skeleton:	Breastplate Grip
Co-ordinates:	Matrix location:	Hinge Bracket
Levels	Preservation:	Fixing nails Shroud pins
Slide No.	Neg No:	Fabric Other finds
Description <i>Funeral will</i> (185) Discussion		
Shape, dimensions and distinguishing characteristics LID HEAD BASE		
Recorder:	Date:	Initials:

db

SITE		COFFIN RECORD SHEET		CONTEXT NO. 187	
Trench: 149	Additional sheets: YES x 1	Treatment: excavated by hand - body transferred to bag - bones collected			
Site sub-div: South of Church	Grave fills: /	Finds			
Plan no: 6	Grave cut: /	None			
Section no: /	Skeleton: 187	Breastplate ✓ decayed + illegible (in bag)			
		Grip ✓			
Co-ordinates: 28m west, 10m S. of church wall	Matrix location:	Hinge			
		Bracket			
Levels	Preservation: wood well preserved skeleton fragmentary.	Fixing nails ✓			
		Shroud pins			
Slide No.	Neg No:	Fabric			
		Other finds			

Description
 Wooden coffin ram packed around skeleton with sawdust. Skeleton decayed - calcified and powdery but so fragments are retained.
 A small red clay face from a clay pipe found under the lid.
Discussion
 Maggot pupae present, pubic hair present - with lice! (in small finds bag).

WOODEN COFFIN WITHIN BRICK LINED GRAVE/VAULT 149

Shape, dimensions and distinguishing characteristics

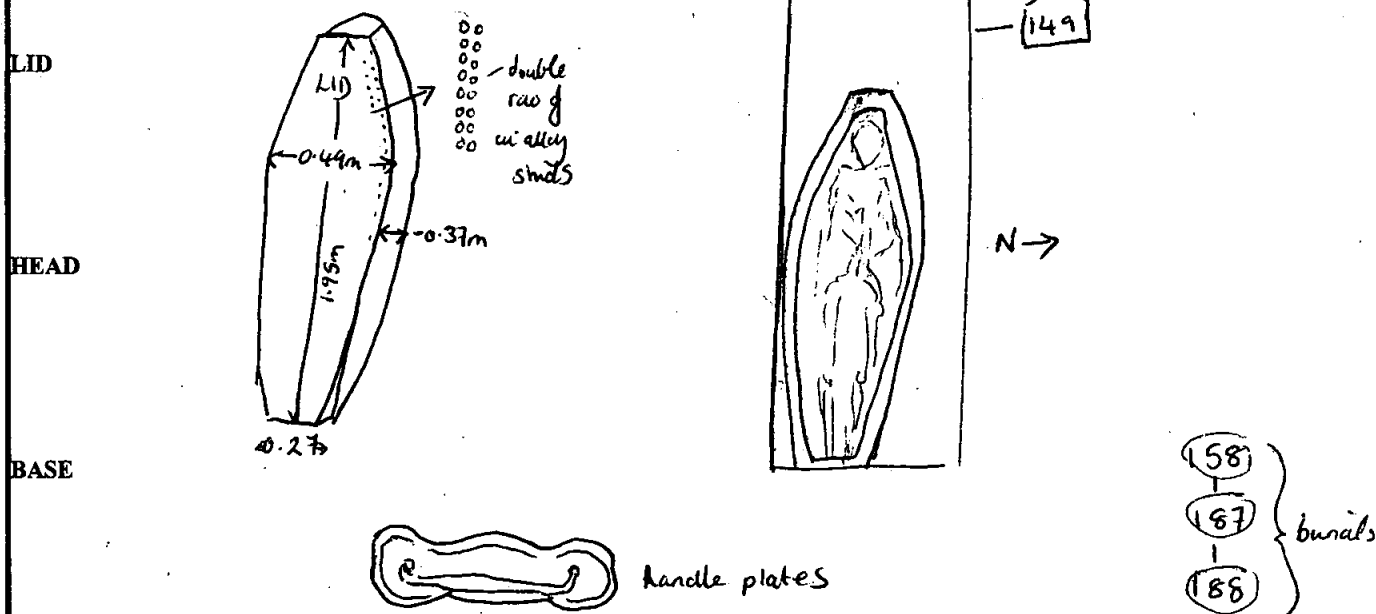

Recorder: S. Lucas	Date: 7-9-2000	Initials:
--------------------	----------------	-----------

Site Code

Context

OLR00

187

Outer Coffin

Sample Ret.

Recording Date 10/10

Associated Numbers

Condition

Fragmentary

Dep. Plate

Legible *NO*

Inscription

Fe plate from coffin in vault - too fragmentary for details

Fabric lead ormolou brass tin plated pewter gilt tin
 iron silvered tin enamelled other Sample Ret.

Shape of dep. plate

square rectangle shield tapered lozenge
 cartouche oval other

Upholstery

colour shoddy velvet other *boyle* Sample Ret.

Construction

butt joint mitred pitched other

Grip plate

Fabric = ormolou brass tin plated pewter gilt tin
 iron silvered tin enamelled other Sample Ret.

Grip

Fabric = ormolou brass iron X6 Sample Ret.

Feags - from previous sheet they would appear to have been ~~2 types~~ 5 types.

Design

swag of rose horseshoe cherub's head plain

other *sptdls (3b)'s*

Grip bolts

Corner bolts Type = gilt brass brass iron

other Sample Ret.

Lid motifs

other Sample Ret.

Escutcheons

other Sample Ret.

Upholstery nails

brass gilt brass silvered brass iron enamelled

other *NOT obtained from fieldwork* Sample Ret.

Fixings

panel nails screws hinges lace Sample Ret.

Timber type

Sample Ret.

Interpretation / Comments

.....

db.

SITE 02R00		COFFIN RECORD SHEET	CONTEXT NO. 188
Trench: 149	Additional sheets: YES x 1	Treatment: Hand excavated Stratigraphically bones collected	
Site sub-div: South of church	Grave fills: /		
Plan no: 6	Grave cut: /	Finds None	
Section no: -	Skeleton: 188	Breastplate ✓ corroded + illegible Grip ✓	
Co-ordinates: 25m West, 10m S of church wall	Matrix location:	Hinge Bracket	
Levels	Preservation: Wood + lead coffin fairly well preserved	Fixing nails ✓ Shroud pins	
Slide No.	Neg No:	Fabric ✓ adhering to bones Other finds flowers on top of coffin	

Description Wooden coffin lined with lead, skeleton inside fairly good condition except skull crushed to powder, some blackened skin adhering to bones. looks like a teenager.

Discussion WOOD COFFIN LINED WITH LEAD WITHIN BRICK LINED GRAVE/VAULT 149.

Shape, dimensions and distinguishing characteristics

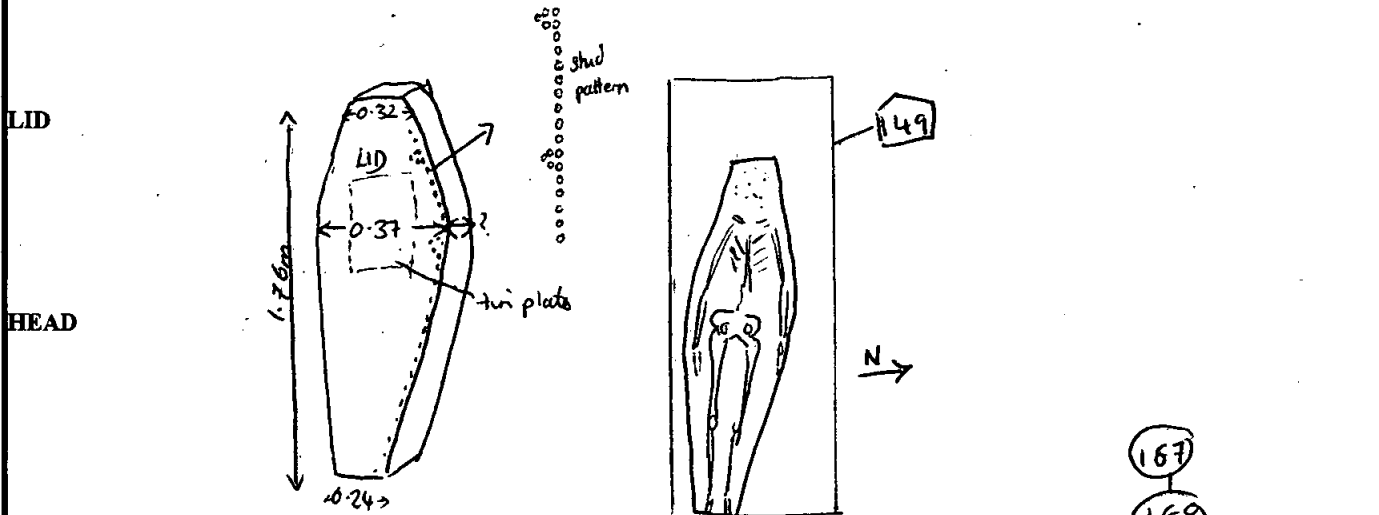

- 167
- 168
- 189

Recorder: P. Lucas	Date: 7-9-2000	Initials:
--------------------	----------------	-----------

Coffin Recording Sheet

Site Code

Context

Outer Coffin

Sample Ret.

Q100

188

Recording Date *12/10*

Associated Numbers

Condition *1*

Dep. Plate

Legible

Fe, in frags.

Inscription *no legible.*

Fabric lead ormolou brass tin plated pewter gilt tin
 iron silvered tin enamelled other Sample Ret.

Shape of dep. plate

square rectangle shield tapered lozenge
 cartouche oval other

Upholstery

colour shoddy velvet other Sample Ret.

Construction

butt joint mitred pitched other

Grip plate Fabric = ormolou brass tin plated pewter gilt tin
 iron silvered tin enamelled other Sample Ret.

Grip Fabric = ormolou brass iron *X3* *(3b)* Sample Ret.

Design swag of rose horseshoe cherub's head plain
 other

Grip bolts Corner bolts Type = gilt brass brass iron
 other Sample Ret.

Lid motifs other Sample Ret.

Escutcheons other Sample Ret.

Upholstery *studs* brass *3x pellets* gilt brass silvered brass iron enamelled
 other *cccc cccc* *ccccccc* Sample Ret.

Fixings panel nails screws hinges lace Sample Ret.

Timber type Sample Ret.

Interpretation / Comments

.....

db.

SITE	COFFIN RECORD SHEET	CONTEXT NO.
02 R00		189
Trench: 149	Additional sheets: YES x 1	Treatment: Hand dug stratigraphically. No bones found.
Site sub-div: South of church	Grave fills /	
Plan no: 6	Grave cut: /	Finds None
Section no: -	Skeleton: 189	Breastplate Grip ✓
Co-ordinates: 26m W. 10m S. of church wall.	Matrix location:	Hinge Bracket
Levels	Preservation: Poor, coffin largely crusted No skeleton remaining.	Fixing nails ✓ Shroud pins
Slide No. -	Neg No:	Fabric Other finds Wood retained

Description: Wooden coffin ^{in alley} with studs & traces of greenish fabric adhering to outside

Discussion: Small babies coffin placed ^{flat} over the feet end on top of (190) and under (188)

Shape, dimensions and distinguishing characteristics

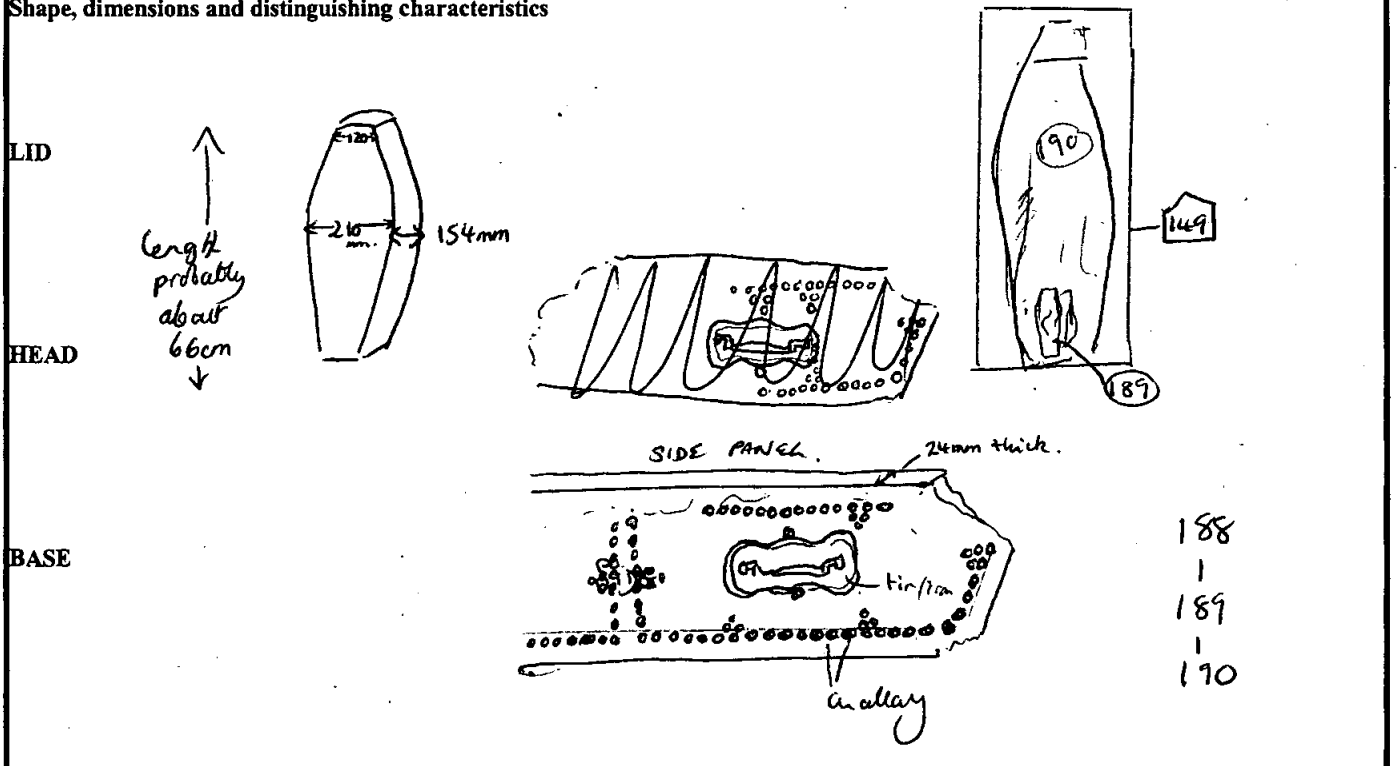

Recorder: J. Lewis	Date: 7. 9. 2000	Initials:
--------------------	------------------	-----------

Coffin Recording Sheet

Outer Coffin

Sample Ret.

Site Code

Context

Recording Date 10/10

OCROO

189

Associated Numbers

Condition

Dep. Plate

Legible

Inscription

Fabric lead ormolou brass tin plated pewter gilt tin
 iron silvered tin enamelled other Sample Ret.

Shape of dep. plate

square rectangle shield tapered lozenge
 cartouche oval other

Upholstery

colour shoddy velvet other boize Sample Ret.

Construction

butt joint mitred pitched other

Grip plate

Fabric = ormolou brass tin plated pewter gilt tin
 iron silvered tin enamelled other Sample Ret.

x 1 head

Grip

Fabric = ormolou brass iron *x7 intent* Sample Ret.

possibly

Design

swag of rose horseshoe cherub's head plain

other *terminal = 0.0085 deep = 0.0025 grip & plate 228.2 & 10 - infant section*

Grip bolts

Corner bolts

Type = gilt brass

brass

iron

other Sample Ret.

Lid motifs

other Sample Ret.

Escutcheons

other Sample Ret.

Upholstery *studs*

nails

brass gilt brass silvered brass iron

enamelled

other *many - see previous sheet for in situ details: could be spuds 3/4/7/11 etc.* Sample Ret.

Fixings

panel nails

screws

hinges

lace

Sample Ret.

Timber type

Sample Ret.

Interpretation / Comments

.....

db.

SITE	COFFIN RECORD SHEET	CONTEXT NO.
0 L R 00		190
Trench: 149	Additional sheets: YES X 1	Treatment: Bones collected
Site sub-div: South of church.	Grave fills: /	
Plan no: 6	Grave cut: /	Finds: None
Section no: -	Skeleton: (190)	Breastplate ✓ Grip ✓
Co-ordinates: 25m W. 10m S. of church wall	Matrix location: -	Hinge Bracket
Levels: -	Preservation: wood and lead coffin in good condition	Fixing nails Shroud pins
Slide No. -	Neg No:	Fabric ✓ Other finds:

Description - Wooden coffin lined with lead.
 Skeleton in fair condition but skull fragmentary. The skin of the face & a face shroud was in place (in bag now) - ~~0.5~~ 0.5cm thick.

Discussion
 WOODEN COFFIN LINED WITH LEAD, CONTAINING SKELETON.

Shape, dimensions and distinguishing characteristics

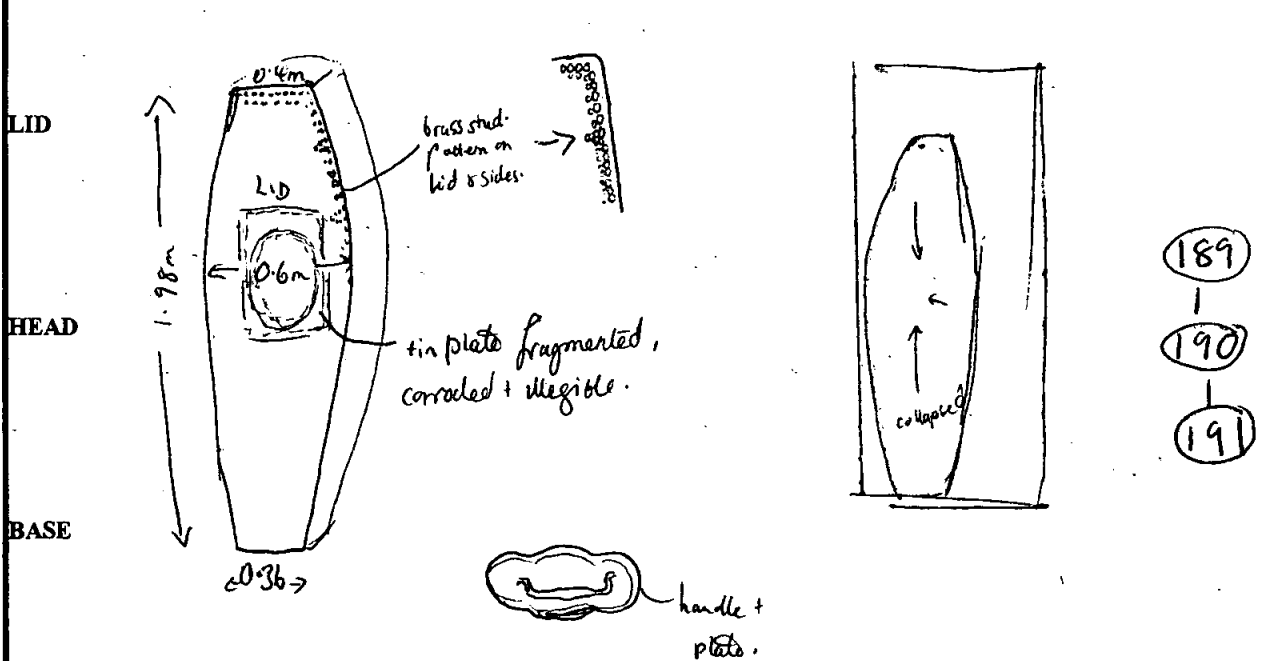

Recorder:	Date:	Initials:
-----------	-------	-----------

Coffin Recording Sheet

Site Code

Context

OLR00

190

Outer Coffin

Sample Ret.

Recording Date 13/10

Associated Numbers

Condition

Dep. Plate

Legible

Inscription

Fragmentary & illegible

Fabric lead ormolou brass tin plated pewter gilt tin
 iron silvered tin enamelled other Sample Ret.

Shape of dep. plate

square rectangle shield tapered lozenge
 cartouche oval other

Upholstery

colour shoddy velvet other Sample Ret.

Construction

butt joint mitred pitched other

Grip plate

Fabric = ormolou brass tin plated pewter gilt tin
Frags on rev. of grip + 1 x corner of (5)
 iron silvered tin enamelled other Sample Ret.

Grip

Fabric = ormolou brass iron ⁴ Sample Ret.

(36)

Design

swag of rose horseshoe cherub's head plain

other

Grip bolts

Corner bolts Type = gilt brass brass iron

other Sample Ret.

Lid motifs

other Sample Ret.

Escutcheons

other Sample Ret.

Upholstery

studs
 brass ^{x 1 piece} gilt brass silvered brass iron enamelled
..... = total of 20 studs
 other

Fixings

panel nails screws hinges lace Sample Ret.

Timber type

Sample Ret.

Interpretation / Comments

.....

db.

SITE	COFFIN RECORD SHEET	CONTEXT NO.
0LR00		191
Trench: 1149	Additional sheets: YES x 2	Treatment: bones collected
Site sub-div: Part of Church	Grave fills: /	
Plan no: 6	Grave cut: /	Finds: None
Section no:	Skeleton: 191	Breastplate: ✓ Grip
Co-ordinates: 28m W. 10m S. of Church Well.	Matrix location:	Hinge Bracket
Levels	Preservation: O.K. - the wood is not as well preserved as those on top. Base decayed away totally.	Fixing nails Shroud pins ✓ on ear of skull.
Slide No.	Neg No:	Fabric Other finds

Description
 Wooden coffin containing very well preserved skeleton of an elderly person of c. 5'5" (Female?). Coffin placed below the level of the bottom course of bricks of the structure. Bottom of coffin 2.29m below top of vault.

Discussion
 WOODEN COFFIN AT BOTTOM OF SEQUENCE OF GRAVES WITHIN 1149 BRICK VAULT.

Shape, dimensions and distinguishing characteristics

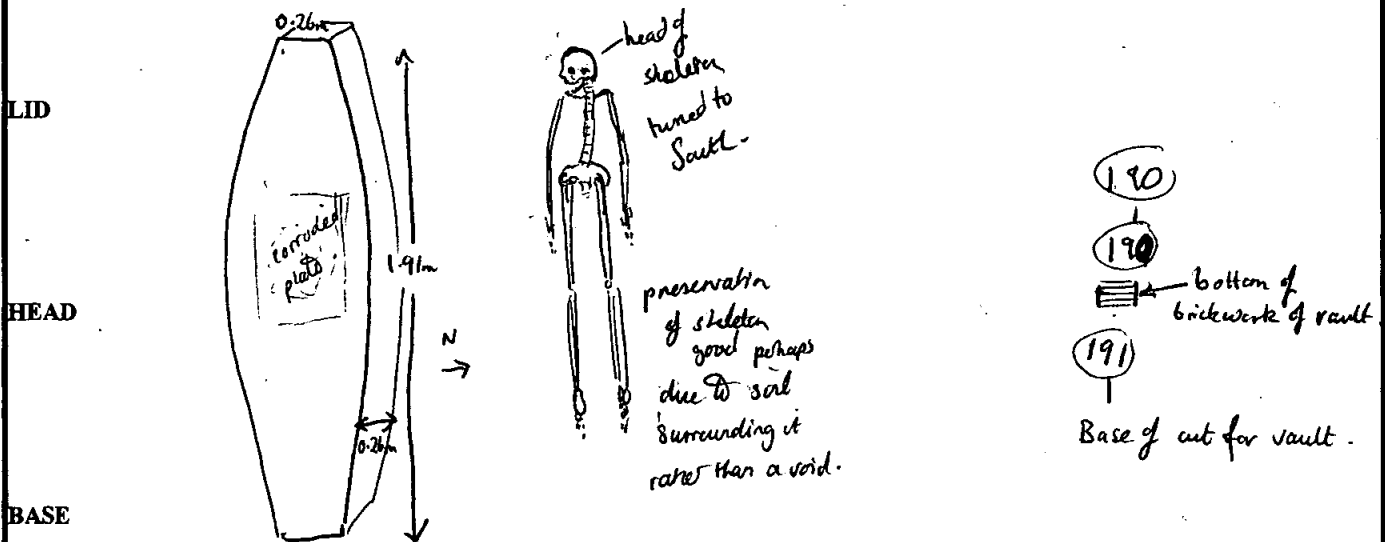

Has an alloy studs decoration of coffin.

Fragment retained.

Recorder: J Lucas	Date: 7-9-2000	Initials:
-------------------	----------------	-----------

Coffin Recording Sheet

Site Code

Context

OH100

191

Outer Coffin

Sample Ret.

Recording Date ~~13/10~~ 13/10

Associated Numbers

Condition 1

Dep. Plate

Legible

Inscription *Ke. frags - too poor to id.*

Fabric lead ormolou brass tin plated pewter gilt tin
 iron silvered tin enamelled other Sample Ret.

Shape of dep. plate ?
 square rectangle shield tapered lozenge
 cartouche oval other

Upholstery
 colour shoddy velvet other Sample Ret.

Construction butt joint mitred pitched other

Grip plate Fabric = ormolou brass tin plated pewter gilt tin
frags on rev. of grip. iron silvered tin enamelled other Sample Ret.

Grip Fabric = ormolou brass iron ^{x2} 36 Sample Ret.

Design swag of rose horseshoe cherub's head plain
 other

Grip bolts Corner bolts Type = gilt brass brass iron
 other Sample Ret.

Lid motifs other Sample Ret.

Escutcheons other Sample Ret.

Upholstery ~~studs~~ ^{studs} brass *X3 pieces.* gilt brass silvered brass iron enamelled
 other *1x 000 1x 000 1x (SEE OVER.) = total of 2A studs.* Sample Ret.

Fixings panel nails screws hinges lace Sample Ret.

Timber type Sample Ret.

Interpretation / Comments

Ohroo

191
cont.

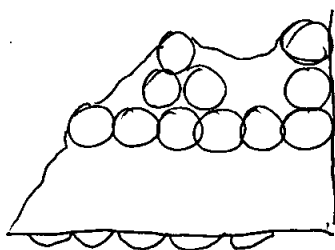

lid edge

db.

SITE	COFFIN RECORD SHEET	CONTEXT NO.
0LR00		192
Trench: <u>208</u>	Additional sheets: YES x 1	Treatment: Bones collected, some coffin frags collected
Site sub-div: NC	Grave fills /	
Plan no: 3	Grave cut: /	Finds None
Section no: -	Skeleton: 192	Breastplate drawn before fragmenting Grip ✓
Co-ordinates:	Matrix location:	Hinge Bracket
Levels	Preservation: coffin OK preservation,	Fixing nails Shroud pins
Slide No. <u>slm 19, 2-16</u>	Neg No:	Fabric Other finds

Description
 Wooden coffin containing skeleton which crumbled when transferred to bag. hid mony - Spitalfields 10.
 Fabric inside - felt stuff.

Discussion
 Uppermost Coffin within vault 208. overlies (194) Lead coffin.
 One coffin surname = Eltham died Early 1800's.

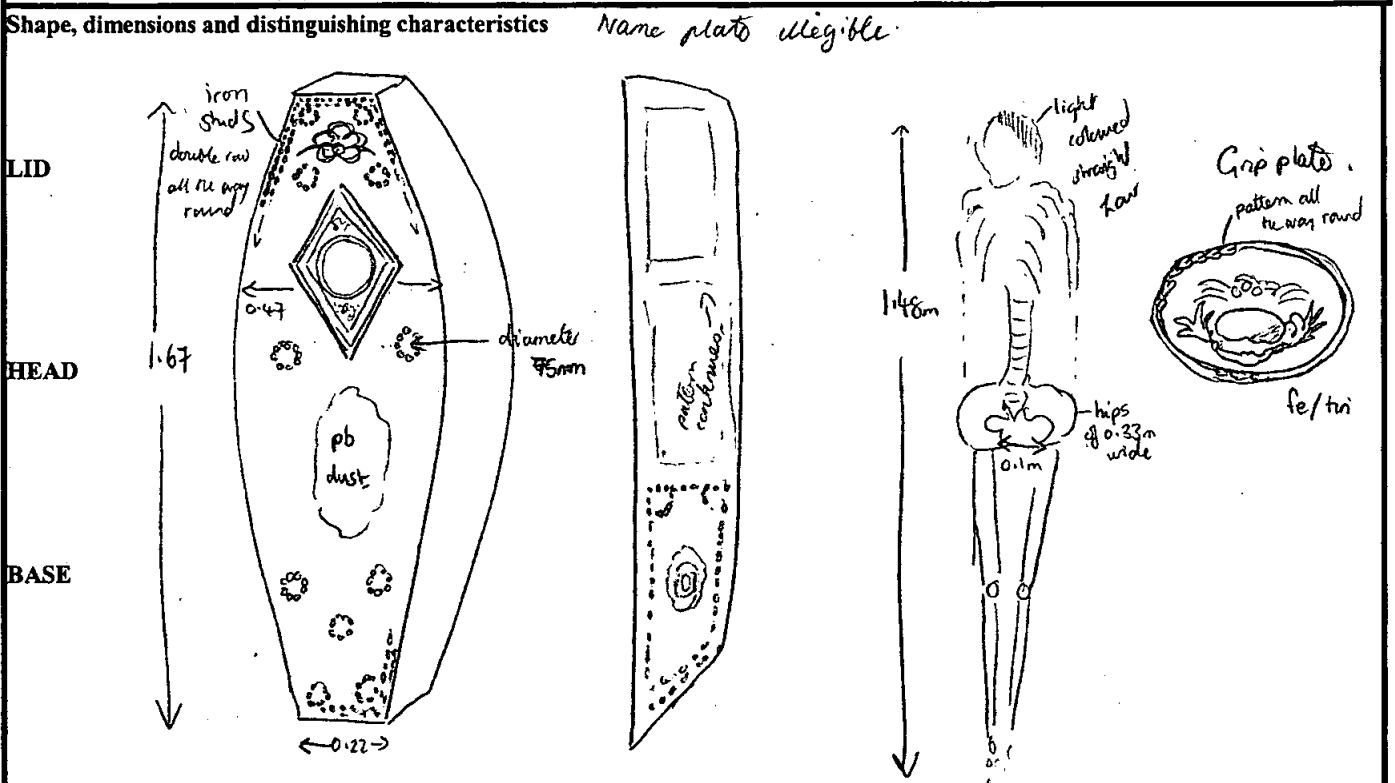

Recorder:	Date:	Initials:
-----------	-------	-----------

Coffin Recording Sheet

Site Code

Context

Outer Coffin

Sample Ret.

02200

192

Recording Date

Associated Numbers

Condition

Dep. Plate

Legible

Inscription

Fabric lead ormolou brass tin plated pewter gilt tin
 iron silvered tin enamelled other Sample Ret.

Shape of dep. plate

square rectangle shield tapered lozenge
 cartouche oval other

Upholstery

colour shoddy *padding on inner wooden case.* velvet other *Hessian/Linen type?* Sample Ret.

Construction butt joint mitred pitched other

Grip plate Fabric = ormolou brass tin plated pewter gilt tin
 iron silvered tin enamelled *Black (3)* other Sample Ret.

Grip Fabric = ormolou brass iron *(A)* Sample Ret.

Design swag of rose horseshoe cherub's head plain
 other

Grip bolts **Corner bolts** Type = gilt brass brass iron
 other Sample Ret.

Lid motifs other *(10) - fe. (seen from fieldwork notes)* Sample Ret.

Escutcheons other Sample Ret.

Upholstery *sheds* nails brass gilt brass silvered brass iron *x 3 pieces* enamelled
 other *(x 000000 1x 000000 1x 000000 0)* Sample Ret.

Fixings panel nails screws hinges lace Sample Ret.

Timber type Sample Ret.

Interpretation / Comments
.....
.....

db.

SITE	COFFIN RECORD SHEET	CONTEXT NO.
02R00		193
Trench: 1208	Additional sheets: 4E5x1.	Treatment: lead coffin only recorded not opened.
Site sub-div: NC	Grave fills: /	
Plan no: 3	Grave cut: /	Finds: None
Section no: -	Skeleton: /	Breastplate: ✓ Grip: ✓
Co-ordinates:	Matrix location:	Hinge Bracket
Levels:	Preservation: Lead doesn't appear to be perforated.	Fixing nails Shroud pins
Slide No. film # 19 216	Neg No:	Fabric Other finds:

Description: Lead coffin with wooden outer coffin much decayed - mainly iron pb decoration, some iron.

Discussion

Shape, dimensions and distinguishing characteristics

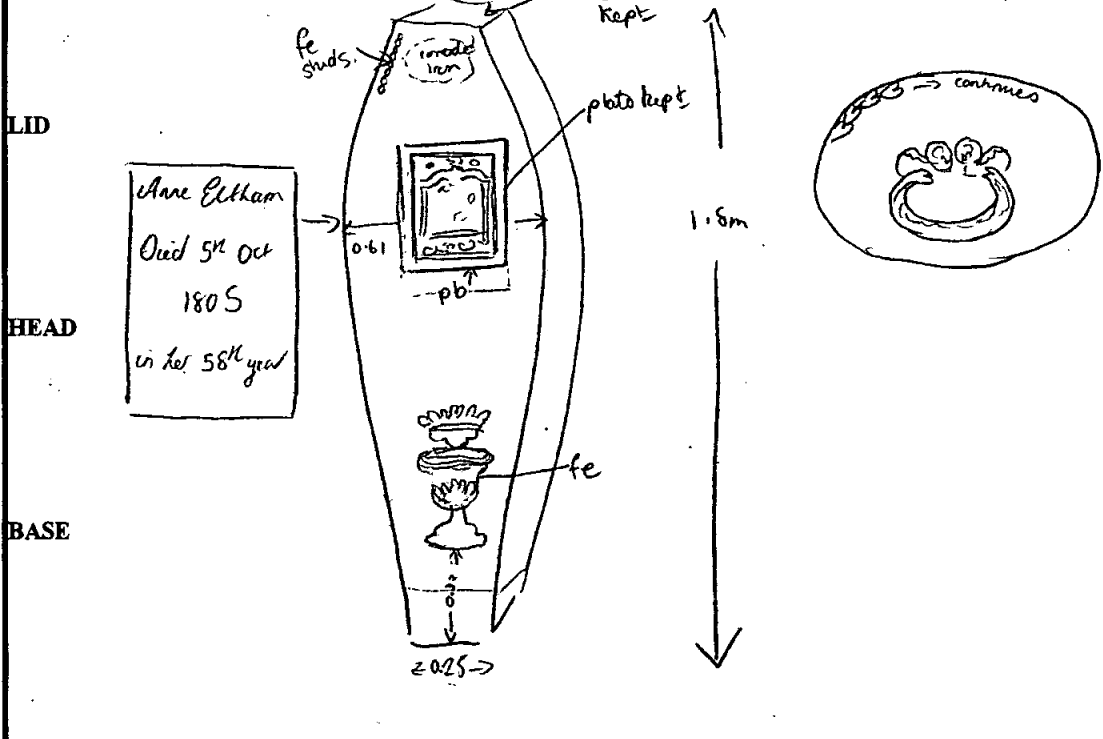

Recorder:	Date:	Initials:
-----------	-------	-----------

Site Code

Context

OLR00

193

Outer Coffin

Sample Ret.

Recording Date 10/10

Associated Numbers

Condition

Dep. Plate

Legible ish

Inscription

"Mrs Ann 'Elliott?'/ Died 13th Octo^r/1805/ In her 58th yr"

Fabric lead

ormolou

brass

tin plated pewter

gilt tin

iron

silvered tin

enamelled

other

Sample Ret.

Shape of dep. plate

square

rectangle

shield

tapered

lozenge

cartouche

oval

other

Spt'ds @ rect. w/out outer border.

Upholstery

colour

shoddy

velvet

other

Sample Ret.

Construction

butt joint

mitred

pitched

other

Grip plate

Fabric = ormolou

brass

tin plated pewter ③

gilt tin

iron

silvered tin

enamelled Block

other

Sample Ret.

Grip

Fabric = ormolou

brass

iron x1

Sample Ret.

Design

swag of rose

horseshoe

cherub's head ④

plain

other

Grip bolts

Corner bolts

Type = gilt brass

brass

iron

other

Sample Ret.

Lid motifs

other *fr. urn-type (not recovered).*

Sample Ret.

Escutcheons

other

Sample Ret.

Upholstery nails

brass

gilt brass

silvered brass

iron

enamelled

other *DONE RECOVERED.* Sample Ret.

Fixings

panel nails

screws

hinges

lace

Sample Ret.

Timber type

Sample Ret.

Interpretation / Comments

.....
.....

db.

SITE	COFFIN RECORD SHEET	CONTEXT NO.
OLROO		194
Trench: 208	Additional sheets:	Treatment: Bones collected DNA sampled
Site sub-div: NC	Grave fills: /	
Plan no: 3	Grave cut: /	Finds: None
Section no: -	Skeleton: 194	Breastplate ✓ decayed. Grip Sulfurid grip 4.
Co-ordinates:	Matrix location:	Hinge Bracket
Levels:	Preservation:	Fixing nails Shroud pins
Slide No: film 19 2-16	Neg No:	Fabric ✓ Other finds:

Description Wooden coffin with lead lining and an internal wood coffin inside that. Shroud fragments. Coffin filled with sawdust which makes the bones decay.

Discussion James Ekham, Died 2nd June 1811, in his 67th year.
DNA taken but teeth v. fragmentary, definitely 1 canine + 2 molars but 2nd canine not sure about.

Lead coffin under (192) inside 208 vault.
shipped with sawdust.

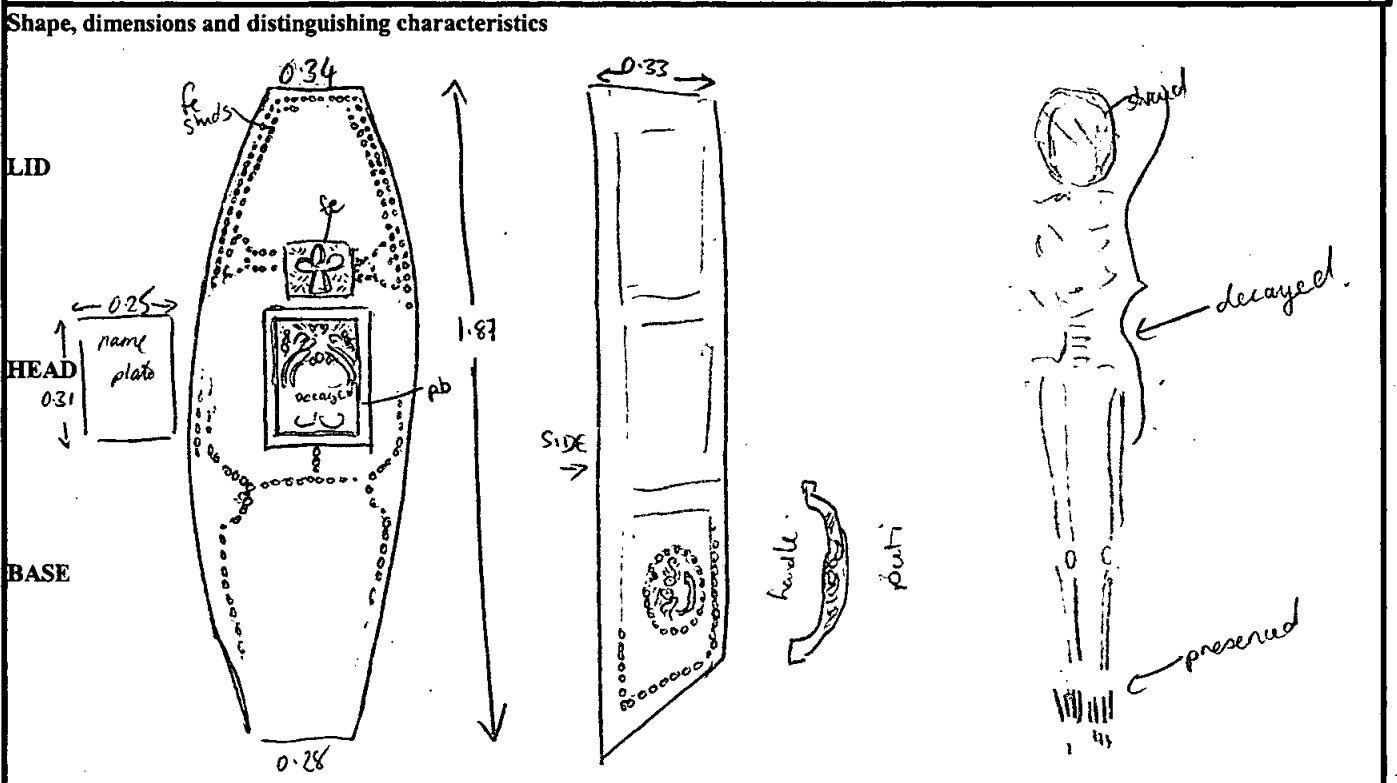

Recorder:	Date:	Initials:
-----------	-------	-----------

Coffin Recording Sheet

Outer Coffin

Sample Ret.

Site Code

Context

Recording Date 20/2/01

OLR00

194

Associated Numbers

Condition

Dep. Plate

Legible *NO. in many frags but enough diagnostic pieces to id. a (6) w/out outer border.*

Inscription

Fabric lead ormolou brass tin plated pewter gilt tin
 iron silvered tin enamelled other Sample Ret.

Shape of dep. plate

square rectangle shield tapered lozenge
 cartouche oval other

Upholstery

colour shoddy velvet other Sample Ret.

Construction

butt joint mitred pitched other

Grip plate

Fabric = ormolou brass tin plated pewter gilt tin
 iron silvered tin enamelled other Sample Ret.
block (3)

Grip

Fabric = ormolou brass iron *x 5 (4)'s* Sample Ret.

Design

swag of rose horseshoe cherub's head *+ x 3 NEW - see sheet.* plain
 other

Grip bolts

Corner bolts Type = gilt brass brass iron

other Sample Ret.

Lid motifs ?

other *4 x frags of dec. pt - unid.* Sample Ret.

Escutcheons ?

other Sample Ret.

Upholstery nails

brass gilt brass silvered brass iron enamelled

other Sample Ret.

Fixings

panel nails screws hinges lace Sample Ret.

Timber type

Sample Ret.

Interpretation / Comments

.....

SITE <i>DLR00</i>		COFFIN RECORD SHEET	CONTEXT NO. <i>195</i>
Trench:	Additional sheets:	Treatment: <i>Bones collected</i>	
Site sub-div: <i>NC</i>	Grave fills <i>/</i>		
Plan no: <i>3</i>	Grave cut: <i>/</i>	Finds None	
Section no: <i>-</i>	Skeleton: <i>195</i>	Breastplate Grip <input checked="" type="checkbox"/>	
Co-ordinates:	Matrix location:	Hinge Bracket	
Levels	Preservation: <i>Wood coffin or bit fragmented. Bones in good condition.</i>	Fixing nails Shroud pins	
Slide No.	Neg No:	Fabric Other finds <i>Studs</i>	
Description <i>Wooden coffin in a compact grave cut of a series of 6 coffins placed one atop another</i>			
Discussion <i>Coffin + skeleton in a family grave, not marked with ledges or brick walls</i>			
<p style="text-align: center;"> $\begin{array}{c} 218 \\ \\ 195 \\ \hline 222 \quad 223 \quad 224 \end{array} \left. \vphantom{\begin{array}{c} 218 \\ \\ 195 \\ \hline 222 \quad 223 \quad 224 \end{array}} \right\} 3 \text{ in one coffin.}$ </p>			
Shape, dimensions and distinguishing characteristics			
LID			
HEAD			
BASE			
Recorder: <i>sm</i>	Date: <i>12.9.2000</i>	Initials:	

db

SITE OLR00	COFFIN RECORD SHEET	CONTEXT NO. 196
Trench:	Additional sheets: YES x 1	Treatment: Machined out due to dangerous section. Bones collected.
Site sub-div: NC	Grave fills /	
Plan no: 3	Grave cut: /	Finds None ✓
Section no: -	Skeleton: 196	Breastplate Grip
Co-ordinates:	Matrix location:	Hinge Bracket
Levels	Preservation: OK.	Fixing nails Shroud pins
Slide No.	Neg No:	Fabric Other finds

Description Skeleton hoisted out by machine with other skeleton together for later disinterment. Wooden coffin.

Discussion Skeleton.

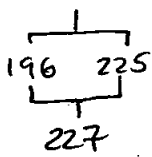
(225) and bagged
~~196 225~~
 227

Shape, dimensions and distinguishing characteristics

LID

HEAD

BASE

Recorder: JMC	Date: 12.9.00	Initials:
---------------	---------------	-----------

Coffin Recording Sheet

Site Code

Context

Outer Coffin

Sample Ret.

OR000

196

Recording Date 15/11/00

Associated Numbers

Condition

Dep. Plate

Legible

Inscription

Fabric lead ormolou brass tin plated pewter gilt tin
 iron silvered tin enamelled other Sample Ret.

Shape of dep. plate

square rectangle shield tapered lozenge
 cartouche oval other

Upholstery

colour shoddy velvet other Sample Ret.

Construction

butt joint mitred pitched other

Grip plate Fabric = ormolou brass tin plated pewter gilt tin
 iron silvered tin enamelled other Sample Ret.

Grip Fabric = ormolou brass iron Sample Ret.

Design swag of rose horseshoe cherub's head plain
 other

Grip bolts **Corner bolts** **Type =** gilt brass brass iron
 other Sample Ret.

Lid motifs other Sample Ret.

Escutcheons other Sample Ret.

Upholstery studs ~~nails~~ brass gilt brass silvered brass iron enamelled
 other pieces of Swedish Pitch. | 1 x 0000 / 4 x 000 / 3 x 00 = 23 studs in total. Sample Ret.

Fixings panel nails screws hinges lace Sample Ret.

Timber type Sample Ret.

Interpretation / Comments

.....

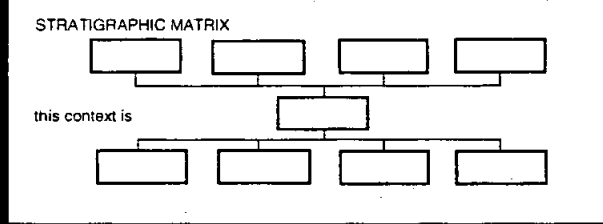
SITE <i>OLR00</i>	CONTEXT RECORD	Context No. 158 <i>197</i>
Additional Sheets:		Type <i>Path.</i>
Trench	Context Type: <i>Deposit / Gut / Structure</i>	Check Lists:
Site sub-div <i>N.C.</i>	Overlain by:	DEPOSIT: 1.compaction 2.colour 3.composition 4.inclusions 5.thickness 6.extent 7.comments 8.method & conditions
Structure No.	Abutted by:	
Plan No. <i>1</i>	Cut by:	CUT: 1.shape in plan 2.base/sides/top profile 3.dimension and depth 4.sketch 5.truncation 6.fill nos 7.other comments
Section No. <i>10, 8</i>	Filled by:	
Co-Ordinates	Same as:	MASONRY: 1.materials 2.size of bricks etc 3.finish of stones 4.coursing/bond 5.form 6.faces 7.bond 8.dimensions as found 9.other comments
Level	Part of:	
Slide No.	Consists of:	Overlies: <i>(198)</i>
Neg No.	Butts:	
Matrix location	Cuts:	Fill of:
Relationships uncertain		
Description (See check lists):		STRATIGRAPHIC MATRIX 
Interpretation/Discussion: <i>Tarmac path surface.</i>		
Finds (tick): None <input type="checkbox"/> Pot <input type="checkbox"/> Bone <input type="checkbox"/> Flint <input type="checkbox"/> Stone <input type="checkbox"/> Burnt stone <input type="checkbox"/> Glass <input type="checkbox"/> Metal <input type="checkbox"/> CBM <input type="checkbox"/> Wood <input type="checkbox"/> Leather <input type="checkbox"/>		
ΔSmall Finds		Recorder
◇Samples		Date
△Building Materials		Initials

SITE	CONTEXT RECORD	Context No.
0LR00	Additional Sheets:	198
Trench	Context Type: Deposit / Cut / Structure	Check Lists:
Site sub-div <i>N.C.</i>	Overlain by: (197)	DEPOSIT: 1.compaction 2.colour 3.composition 4.inclusions 5.thickness 6.extent 7.comments 8.method & conditions
Structure No.	Abutted by:	
Plan No.	Cut by:	CUT: 1.shape in plan 2.base/sides/top profile 3.dimension and depth 4.sketch 5.truncation 6.fill nos 7.other comments
	Filled by:	
Section No. <i>8</i>	Same as:	MASONRY: 1.materials 2.size of bricks etc 3.finish of stones 4.coursing/bond 5.form 6.faces 7.bond 8.dimensions as found 9.other comments
	Part of:	
Co-Ordinates	Consists of:	
	Overlies: (199)	
Level	Butts:	
Slide No.	Cuts:	
Neg No.	Fill of:	
Matrix location	Relationships uncertain	
Description (See check lists):		<div style="border: 1px solid black; padding: 5px;"> <p style="text-align:center; margin:0;">STRATIGRAPHIC MATRIX</p> <pre> graph TD A[] --- B[] A --- C[] A --- D[] A --- E[] B --- F[] C --- F[] D --- F[] E --- F[] F --- G[] F --- H[] F --- I[] F --- J[] </pre> </div>
Interpretation/Discussion:		
<i>Tarmac/ gravel foundation</i>		
Finds (tick): None <input type="checkbox"/> Pot <input type="checkbox"/> Bone <input type="checkbox"/> Flint <input type="checkbox"/> Stone <input type="checkbox"/> Burnt stone <input type="checkbox"/> Glass <input type="checkbox"/> Metal <input type="checkbox"/> CBM <input type="checkbox"/> Wood <input type="checkbox"/> Leather <input type="checkbox"/>		
ΔSmall Finds	Recorder	
◇Samples	Date	
△Building Materials	Initials	

SITE <i>OLR00</i>	CONTEXT RECORD	Context No. <i>199</i>
	Additional Sheets:	Type <i>layer</i>
Trench	Context Type: Deposit / Cut / Structure	Check Lists:
Site sub-div <i>N.C.</i>	Overlain by:	DEPOSIT: 1.compaction 2.colour 3.composition 4.inclusions 5.thickness 6.extent 7.comments 8.method & conditions
Structure No.	Abuted by:	
Plan No. <i>8</i>	Cut by:	CUT: 1.shape in plan 2.base/sides/top profile 3.dimension and depth 4.sketch 5.truncation 6.fill nos 7.other comments
	Filled by:	
Section No. <i>10, 8</i>	Same as:	MASONRY: 1.materials 2.size of bricks etc 3.finish of stones 4.coursing/bond 5.form 6.faces 7.bond 8.dimensions as found 9.other comments
	Part of:	
Co-Ordinates	Consists of:	
	Overlies: <i>(177)</i>	
Level	Butts:	
Slide No.	Cuts:	
Neg No.	Fill of:	
Matrix location	Relationships uncertain	
Description (See check lists):		<p style="text-align:center;">STRATIGRAPHIC MATRIX</p>
Interpretation/Discussion:		
<i>Gravel make-up.</i>		
Finds (tick): None <input type="checkbox"/> Pot <input type="checkbox"/> Bone <input type="checkbox"/> Flint <input type="checkbox"/> Stone <input type="checkbox"/> Burnt stone <input type="checkbox"/> Glass <input type="checkbox"/> Metal <input type="checkbox"/> CBM <input type="checkbox"/> Wood <input type="checkbox"/> Leather <input type="checkbox"/>		
ΔSmall Finds	Recorder	
◇Samples	Date	
△Building Materials	Initials	

SITE <i>OLR00</i>	CONTEXT RECORD	Context No. <i>200</i>
Additional Sheets:		Type <i>Fill</i>
Trench	Context Type: Deposit / Cut / Structure	Check Lists:
Site sub-div <i>N.C.</i>	Overlain by:	DEPOSIT: 1.compaction 2.colour 3.composition 4.inclusions 5.thickness 6.extent 7.comments 8.method & conditions
Structure No.	Abutted by:	
Plan No.	Cut by:	CUT: 1.shape in plan 2.base/sides/top profile 3.dimension and depth 4.sketch 5.truncation 6.fill nos 7.other comments
Section No. <i>8</i>	Filled by:	
Co-Ordinates	Same as:	MASONRY: 1.materials 2.size of bricks etc 3.finish of stones 4.coursing/bond 5.form 6.places 7.bond 8.dimensions as found 9.other comments
Level	Part of:	
Slide No.	Consists of:	Relationships uncertain
Neg No.	Overlies:	
Matrix location	Butts:	Cuts:
Description (See check lists):		
Interpretation/Discussion: <i>Backfill of drain trench.</i>		Findings:
Findings: None <input type="checkbox"/> Pot <input type="checkbox"/> Bone <input type="checkbox"/> Flint <input type="checkbox"/> Stone <input type="checkbox"/> Burnt stone <input type="checkbox"/> Glass <input type="checkbox"/> Metal <input type="checkbox"/> CBM <input type="checkbox"/> Wood <input type="checkbox"/> Leather <input type="checkbox"/>		STRATIGRAPHIC MATRIX
ΔSmall Finds	Recorder	
◇Samples	Date	
ΔBuilding Materials	Initials	

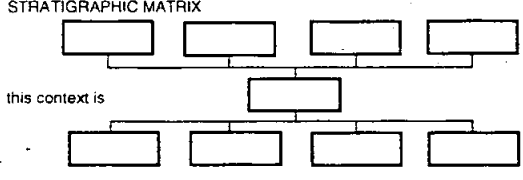
SITE <i>OLR00</i>	CONTEXT RECORD		Context No. <i>201</i>
Additional Sheets:		Type <i>DRAIN</i>	
Trench	Context Type: <i>Deposit / Cut / Structure</i>		Check Lists:
Site sub-div <i>NC.</i>	Overlain by:	DEPOSIT: 1.compaction 2.colour 3.composition 4.inclusions 5.thickness 6.extent 7.comments 8.method & conditions	
Structure No.	Abutted by:		
Plan No. <i>3</i>	Cut by:		
Section No. <i>8</i>	Filled by:	CUT: 1.shape in plan 2.base/sides/top profile 3.dimension and depth 4.sketch 5.truncation 6.fill nos 7.other comments	
Co-Ordinates	Same as:		
Level	Part of:	MASONRY: 1.materials 2.size of bricks etc 3.finish of stones 4.coursing/bond 5.form 6.faces 7.bond 8.dimensions as found 9.other comments	
Slide No.	Consists of:		
Neg No.	Overlies:		
Matrix location	Butts:		
Description (See check lists):	Cuts:	STRATIGRAPHIC MATRIX 	
<i>Brick drain - brick base with brick sides to arched roof 0.65m wide, 0.60m from base to top of arch. Seen for c. 5m from western sect of NC. excavation (sect 8) to a soak away situated c. 2m from church to the NE of the NW corner door. Soak away: - 1.20m Ø brick - capped with brick dome, 1.20-1.30m below current ground surface</i>	Fill of: <i>202</i>		
Interpretation/Discussion:	Relationships uncertain	this context is	
<i>Brick Drain and soak away. (-Appears to be immediately post church construction).</i>			
Finds (tick): None <input type="checkbox"/> Pot <input type="checkbox"/> Bone <input type="checkbox"/> Flint <input type="checkbox"/> Stone <input type="checkbox"/> Burnt stone <input type="checkbox"/> Glass <input type="checkbox"/> Metal <input type="checkbox"/> CBM <input type="checkbox"/> Wood <input type="checkbox"/> Leather <input type="checkbox"/>			
Δ Small Finds	Recorder <i>DS</i>		
◇ Samples	Date <i>7/9</i>		
◊ Building Materials	Initials		

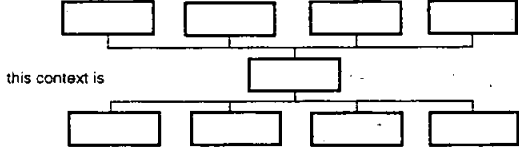
SITE <i>ORL00</i>	CONTEXT RECORD		Context No. <i>202</i>
Additional Sheets:		Type <i>Cut</i>	
Trench	Context Type: Deposit / Cut / Structure		Check Lists:
Site sub-div <i>NS.</i>	Overlain by:		DEPOSIT: 1.compaction 2.colour 3.composition 4.inclusions 5.thickness 6.extent 7.comments 8.method & conditions
Structure No.	Abutted by:		
Plan No. <i>3</i>	Cut by:		
Section No. <i>8</i>	Filled by: <i>200 & 201</i>		CUT: 1.shape in plan 2.base/sides/top profile 3.dimension and depth 4.sketch 5.truncation 6.fill nos 7.other comments
Co-Ordinates	Same as:		
Level	Part of:		
Slide No.	Consists of:		MASONRY: 1.materials 2.size of bricks etc 3.finish of stones 4.coursing/bond 5.form 6.faces 7.bond 8.dimensions as found 9.other comments
Neg No.	Overlies:		
Matrix location	Butts:		
Description (See check lists):		Relationships uncertain	
		STRATIGRAPHIC MATRIX 	
Interpretation/Discussion: <i>Cut for brick drain.</i>			
Finds (tick): None <input type="checkbox"/> Pot <input type="checkbox"/> Bone <input type="checkbox"/> Flint <input type="checkbox"/> Stone <input type="checkbox"/> Burnt stone <input type="checkbox"/> Glass <input type="checkbox"/> Metal <input type="checkbox"/> CBM <input type="checkbox"/> Wood <input type="checkbox"/> Leather <input type="checkbox"/>			
<input type="checkbox"/> Small Finds			Recorder
<input type="checkbox"/> Samples			Date
<input type="checkbox"/> Building Materials			Initials

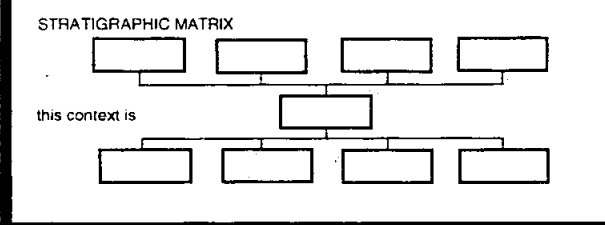
SITE <i>0LR00</i>	CONTEXT RECORD	Context No. <i>203</i>
Additional Sheets:		Type <i>Fill</i>
Trench	Context Type: Deposit / Cut / Structure	Check Lists:
Site sub-div	Overlain by:	DEPOSIT: 1.compaction 2.colour 3.composition 4.inclusions 5.thickness 6.extent 7.comments 8.method & conditions
Structure No.	Abutted by:	
Plan No.	Cut by:	CUT: 1.shape in plan 2.base/sides/top profile 3.dimension and depth 4.sketch 5.truncation 6.fill nos 7.other comments
Section No. <i>8</i>	Filled by:	
Co-Ordinates	Same as:	MASONRY: 1.materials 2.size of bricks etc 3.finish of stones 4.coursing/bond 5.form 6.faces 7.bond 8.dimensions as found 9.other comments
Level	Part of:	
Slide No.	Consists of:	MASONRY: 1.materials 2.size of bricks etc 3.finish of stones 4.coursing/bond 5.form 6.faces 7.bond 8.dimensions as found 9.other comments
Neg No.	Overlies:	
Matrix location	Butts:	MASONRY: 1.materials 2.size of bricks etc 3.finish of stones 4.coursing/bond 5.form 6.faces 7.bond 8.dimensions as found 9.other comments
Description (See check lists):	Cuts:	
Description (See check lists):	Fill of: <i>204</i>	Relationships uncertain
Description (See check lists):		
Description (See check lists):		STRATIGRAPHIC MATRIX 
Interpretation/Discussion:		<i>Backfill of construction cut for brick step base.</i>
Finds (tick): None <input type="checkbox"/> Pot <input type="checkbox"/> Bone <input type="checkbox"/> Flint <input type="checkbox"/> Stone <input type="checkbox"/> Burnt stone <input type="checkbox"/> Glass <input type="checkbox"/> Metal <input type="checkbox"/> CBM <input type="checkbox"/> Wood <input type="checkbox"/> Leather <input type="checkbox"/>		Recorder
ΔSmall Finds		Date
◇Samples		Initials
ΔBuilding Materials		Initials

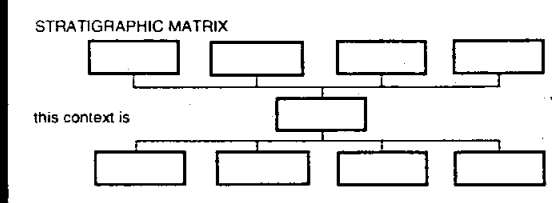
SITE <i>OLR00</i>	CONTEXT RECORD	Context No. <i>204</i>
	Additional Sheets:	Type <i>Cut</i>
Trench	Context Type: Deposit / Cut / Structure	Check Lists:
Site sub-div <i>NS</i>	Overlain by:	DEPOSIT: 1.compaction 2.colour 3.composition 4.inclusions 5.thickness 6.extent 7.comments 8.method & conditions
Structure No.	Abutted by:	
Plan No.	Cut by:	CUT: 1.shape in plan 2.base/sides/top profile 3.dimension and depth 4.sketch 5.truncation 6.fill nos 7.other comments
Section No. <i>8</i>	Filled by: <i>203 & 207</i>	
Co-Ordinates	Same as:	MASONRY: 1.materials 2.size of bricks etc 3.finish of stones 4.coursing/bond 5.form 6.faces 7.bond 8.dimensions as found 9.other comments
Level	Part of:	
Slide No.	Consists of:	
Neg No.	Overlies:	
Matrix location	Butts:	
	Cuts:	
	Fill of:	
	Relationships uncertain	
Description (See check lists):		STRATIGRAPHIC MATRIX 
Interpretation/Discussion: <i>Cut for construction of brick step base or possibly the whole church of church</i>		
Finds (tick): None <input type="checkbox"/> Pot <input type="checkbox"/> Bone <input type="checkbox"/> Flint <input type="checkbox"/> Stone <input type="checkbox"/> Burnt stone <input type="checkbox"/> Glass <input type="checkbox"/> Metal <input type="checkbox"/> CBM <input type="checkbox"/> Wood <input type="checkbox"/> Leather <input type="checkbox"/>		
ΔSmall Finds	Recorder	
◇Samples	Date	
ΔBuilding Materials	Initials	

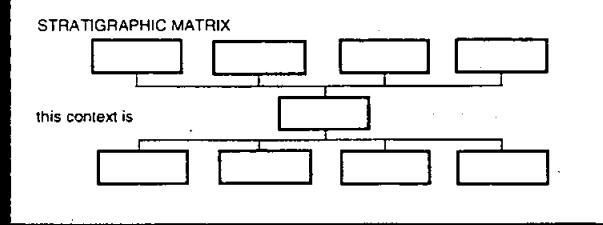
SITE <i>OLR00</i>	CONTEXT RECORD	Context No. <i>205</i>
	Additional Sheets:	Type <i>layer</i>
Trench	Context Type: Deposit / Cut / Structure	Check Lists:
Site sub-div <i>NS</i>	Overlain by: <i>180</i>	DEPOSIT: 1.compaction 2.colour 3.composition 4.inclusions 5.thickness 6.extent 7.comments 8.method & conditions
Structure No.	Abutted by:	
Plan No.	Cut by:	CUT: 1.shape in plan 2.base/sides/top profile 3.dimension and depth 4.sketch 5.truncation 6.fill nos 7.other comments
	Filled by:	
Section No. <i>8, 10,</i>	Same as:	MASONRY: 1.materials 2.size of bricks etc 3.finish of stones 4.coursing/bond 5.form 6.faces 7.bond 8.dimensions as found 9.other comments
	Part of:	
Co-Ordinates	Consists of:	
	Overlies:	
Level	Butts:	
Slide No.	Cuts:	
Neg No.	Fill of:	
Matrix location	Relationships uncertain	
Description (See check lists):		STRATIGRAPHIC MATRIX 
Interpretation/Discussion:		
<i>Layer, Pre-church construction layer Garden soil?</i>		
Finds (tick): None <input type="checkbox"/> Pot <input type="checkbox"/> Bone <input type="checkbox"/> Flint <input type="checkbox"/> Stone <input type="checkbox"/> Burnt stone <input type="checkbox"/> Glass <input type="checkbox"/> Metal <input type="checkbox"/> CBM <input type="checkbox"/> Wood <input type="checkbox"/> Leather <input type="checkbox"/>		
ΔSmall Finds	Recorder	
◇Samples	Date	
△Building Materials	Initials	

SITE <i>OLR00</i>		CONTEXT RECORD		Context No. <i>206</i>
Trench		Additional Sheets:		Type <i>layer</i>
Site sub-div		Context Type: Deposit / Cut / Structure		Check Lists:
Structure No.		Overlain by: <i>205</i>		DEPOSIT: 1.compaction 2.colour 3.composition 4.inclusions 5.thickness 6.extent 7.comments 8.method & conditions
Plan No.		Abutted by:		
Section No. <i>8</i>		Cut by:		CUT: 1.shape in plan 2.base/sides/top profile 3.dimension and depth 4.sketch 5.function 6.fill nos 7.other comments
Co-Ordinates		Filled by:		
Level		Same as:		MASONRY: 1.materials 2.size of bricks etc 3.finish of stones 4.coursing/bond 5.form 6.faces 7.bond 8.dimensions as found 9.other comments
Slide No.		Part of:		
Neg No.		Consists of:		
Matrix location		Overlies:		
Description (See check lists):		Butts:		
		Cuts:		
		Fill of:		
		Relationships uncertain		
		<p>STRATIGRAPHIC MATRIX</p> <pre> graph TD A[] --- B[] A --- C[] A --- D[] A --- E[] B --- F[] C --- F[] D --- F[] E --- F[] F --- G[] F --- H[] F --- I[] F --- J[] </pre>		
Interpretation/Discussion:				
<i>Layer, Pre-church construction</i>				
Finds (tick): None <input type="checkbox"/> Pot <input type="checkbox"/> Bone <input type="checkbox"/> Flint <input type="checkbox"/> Stone <input type="checkbox"/> Burnt stone <input type="checkbox"/> Glass <input type="checkbox"/> Metal <input type="checkbox"/> CBM <input type="checkbox"/> Wood <input type="checkbox"/> Leather <input type="checkbox"/>				
△Small Finds		Recorder		
◇Samples		Date		
△Building Materials		Initials		

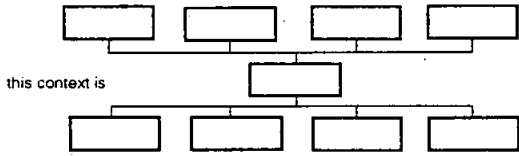
SITE <i>OLR00</i>	CONTEXT RECORD Additional Sheets:	Context No. <i>207</i> Type <i>Steps base</i>
Trench	Context Type: <i>Deposit / Cut / Structure</i>	Check Lists:
Site sub-div <i>NS</i>	Overlain by:	DEPOSIT: 1.compaction 2.colour 3.composition 4.inclusions 5.thickness 6.extent 7.comments 8.method & conditions
Structure No.	Abutted by:	
Plan No. <i>3</i>	Cut by:	CUT: 1.shape in plan 2.base/sides/top profile 3.dimension and depth 4.sketch 5.truncation 6.fill nos 7.other comments
	Filled by:	
Section No. <i>8</i>	Same as:	MASONRY: 1.materials 2.size of bricks etc 3.finish of stones 4.coursing/bond 5.form 6.faces 7.bond 8.dimensions as found 9.other comments
	Part of:	
Co-Ordinates	Consists of:	
	Overlies:	
Level	Butts:	
Slide No.	Cuts:	
Neg No.	Fill of:	
Matrix location	Relationships uncertain	
Description (See check lists): _____ _____ _____ _____ _____ _____ _____ _____ _____ _____		STRATIGRAPHIC MATRIX 
Interpretation/Discussion: <i>Brick base for steps</i> _____ _____ _____ _____ _____ _____ _____ _____		
Finds (tick): None <input type="checkbox"/> Pot <input type="checkbox"/> Bone <input type="checkbox"/> Flint <input type="checkbox"/> Stone <input type="checkbox"/> Burnt stone <input type="checkbox"/> Glass <input type="checkbox"/> Metal <input type="checkbox"/> CBM <input type="checkbox"/> Wood <input type="checkbox"/> Leather <input type="checkbox"/>		
ΔSmall Finds		Recorder
◇Samples		Date
ΔBuilding Materials		Initials

SITE <i>OLR 00</i>		CONTEXT RECORD		Context No. <i>208</i>
Trench		Additional Sheets:		Type <i>Vault</i>
Site sub-div <i>NS</i>		Context Type: <i>Deposit / Cut / Structure</i>		Check Lists:
Structure No.		Overlain by:		DEPOSIT: 1.compaction 2.colour 3.composition 4.inclusions 5.thickness 6.extent 7.comments 8.method & conditions
Plan No. <i>3</i>		Abutted by:		
Section No. <i>9</i>		Cut by:		CUT: 1.shape in plan 2.base/sides/top profile 3.dimension and depth 4.sketch 5.truncation 6.fill nos 7.other comments
Co-Ordinates		Filled by: <i>(192), (193) & (194) burials.</i>		
Level		Same as:		MASONRY: 1.materials 2.size of bricks etc 3.finish of stones 4.coursing/bond 5.form 6.faces 7.bond 8.dimensions as found 9.other comments
Slide No.		Part of:		
Neg No.		Consists of:		
Matrix location		Overlies:		
		Butts:		
		Cuts:		
		Fill of:		
		Relationships uncertain		

Description (See check lists):

Brick vault with ^{45°} slab and 4 steps leading down to the upper half of it.
Brick description: mid orange / yellow orange, 220 x 63 x ? mm. Steps = 2 courses of brick capped with limestone/sandstone slab 45mm thick. ca 3 coffins ~~with~~ - 2 lead, one wood + a skull in NE corner & ^{humeral} jaw-bone under 193 - probably channel from construction cut.
See add sheet

STRATIGRAPHIC MATRIX

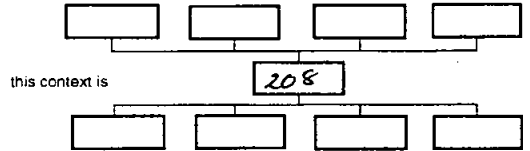

Interpretation/Discussion:

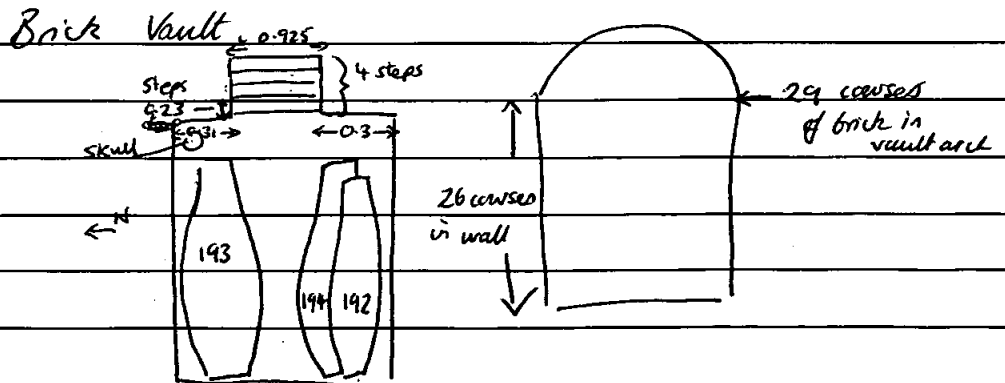

Finds (tick): None Pot Bone Flint Stone Burnt stone Glass Metal
 CBM Wood Leather

△ Small Finds

Recorder *SM*

◇ Samples

Date *8.9.00*

△ Building Materials

Initials

SITE
0LR00

CONTEXT RECORD ADDITIONAL SHEET

Context No.
208

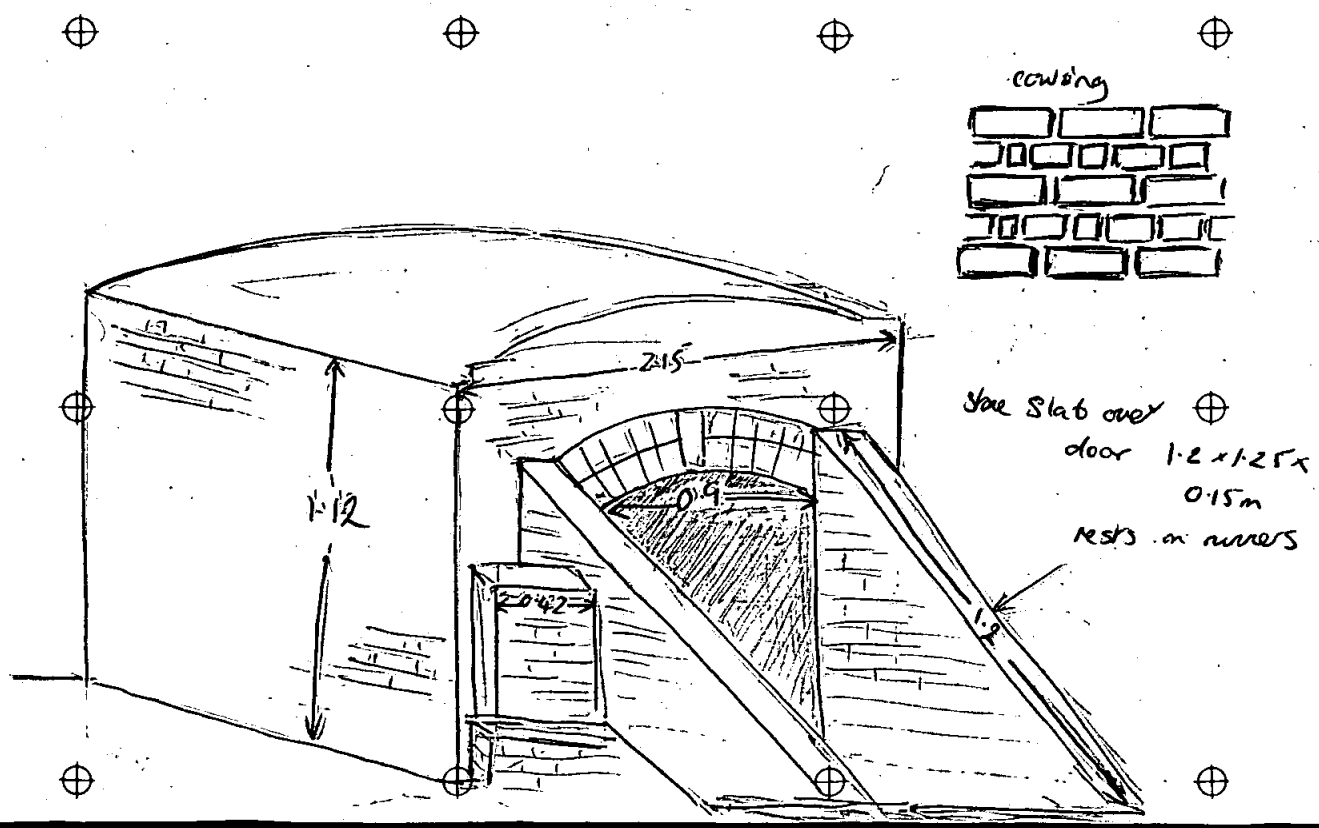

Site Code

Context

OK 200

209

Outer Coffin

Sample Ret.

Recording Date 11/10

Associated Numbers

Condition

Dep. Plate

Legible

Inscription

Fabric lead ormolou brass tin plated pewter gilt tin
 iron silvered tin enamelled other Sample Ret.

Shape of dep. plate

square rectangle shield tapered lozenge
 cartouche oval other

Upholstery

colour shoddy velvet other Sample Ret.

Construction

butt joint mitred pitched other

Grip plate Fabric = ormolou brass tin plated pewter gilt tin
 iron silvered tin enamelled other Sample Ret.

knags on rev of grip

Grip Fabric = ormolou brass iron x1 Sample Ret.

30

Design swag of rose horseshoe cherub's head plain
 other

Grip bolts Corner bolts Type = gilt brass brass iron

other Sample Ret.

Lid motifs other Sample Ret.

Escutcheons other Sample Ret.

Upholstery ^{studs} ~~nails~~ brass gilt brass silvered brass iron enamelled

other = single studs Sample Ret.

Fixings panel nails screws hinges lace Sample Ret.

Timber type Sample Ret.

Interpretation / Comments

.....

SITE <i>OLROO</i>		COFFIN RECORD SHEET	CONTEXT NO. <i>210</i>
Trench:	Additional sheets:	Treatment: <i>Found during machining</i>	
Site sub-div: <i>NU</i>	Grave fills <i>/</i>	<i>Bones collected</i>	
Plan no: <i>3</i>	Grave cut: <i>/</i>	Finds None <input checked="" type="checkbox"/>	
Section no: <i>-</i>	Skeleton: <i>210</i>	Breastplate Grip	
Co-ordinates:	Matrix location:	Hinge Bracket	
Levels	Preservation: <i>No coffin, not all re skeleton retrieved</i>	Fixing nails Shroud pins	
Slide No.	Neg No:	Fabric Other finds	
Description <i>E → W orientated skeleton with no coffin remains halfway down the body / bone retrieval and skull was found just below this one i.e. (211).</i>			
Discussion <i>Burial.</i>			
Shape, dimensions and distinguishing characteristics <i>No coffin.</i>			
LID			
HEAD			
BASE			
Recorder:	Date: <i>11.9.2000</i>	Initials: <i>SML</i>	

SITE	COFFIN RECORD SHEET	CONTEXT NO.
OLR00		211
Trench:	Additional sheets:	Treatment: <i>Bones collected.</i>
Site sub-div: <i>NC</i>	Grave fills <i>/</i>	<i>Found during machining</i>
Plan no: <i>3</i>	Grave cut: <i>/</i>	Finds None
Section no: <i>-</i>	Skeleton: <i>211</i>	Breastplate Grip
Co-ordinates:	Matrix location:	Hinge Bracket
Levels	Preservation: <i>Skull and upper body - found but lower legs & toes not.</i>	Fixing nails Shroud pins
Slide No.	Neg No:	Fabric Other finds
<p>Description <i>E → W skeleton found just below (210) - skull found below pelvis^{area} of (210). No coffin found</i></p> <p>Discussion <i>Burial</i></p> <p>Shape, dimensions and distinguishing characteristics <i>No coffin</i></p> <p>LID</p> <p>HEAD</p> <p>BASE</p>		
Recorder: <i>gml</i>	Date: <i>11-9-2000</i>	Initials:

Ab.

SITE OLR00	COFFIN RECORD SHEET	CONTEXT NO. 212
Trench: VAULT 110	Additional sheets: YES x2.	Treatment: partial fleshed remains: bones not kept. Yuk!
Site sub-div: NC	Grave fills	
Plan no: 3	Grave cut:	Finds None
Section no:	Skeleton:	Breastplate Grip
Co-ordinates:	Matrix location: under 116. vault 110	Hinge Bracket
Levels As vault 110	Preservation: Partial flesh / sinew.	Fixing nails Shroud pins
Slide No.	Neg No:	Fabric Other finds
<p>Description outer wood coffin - decayed, lead coffin - Inner wood coffin -</p> <p>Discussion skeleton - partial flesh preserved, coffin waterlogged - bones not collected.</p>		
<p>Shape, dimensions and distinguishing characteristics</p> <p><u>NB.</u> lead plate on lead coffin appears to have been removed.</p> <p>LID</p> <p>HEAD</p> <p>BASE</p>		
Recorder: DS.	Date: 11/9	Initials: DS.

Coffin Recording Sheet

Site Code

Context

Outer Coffin

Sample Ret.

OH100

212

Recording Date *19/10*

Associated Numbers

Condition

Dep. Plate

Legible

Inscription

Fabric lead ormolou brass tin plated pewter gilt tin
 iron silvered tin enamelled other Sample Ret.

Shape of dep. plate

square rectangle shield tapered lozenge
 cartouche oval other

Upholstery

colour shoddy velvet other *Boize* Sample Ret.

Construction

butt joint mitred pitched other

Grip plate Fabric = ormolou brass tin plated pewter gilt tin
 iron silvered tin enamelled other Sample Ret.

Grip Fabric = ormolou brass iron Sample Ret.

Design swag of rose horseshoe cherub's head plain
 other

Grip bolts Corner bolts Type = gilt brass brass iron
 other Sample Ret.

Lid motifs other Sample Ret.

Escutcheons other *cu alloy x 3 w/ gilt. - no match w/ spfcds.* Sample Ret.

Upholstery ^{studs} ~~nails~~ brass *x 1 piece (see following sheet)* gilt brass silvered brass iron enamelled
 other Sample Ret.

Fixings panel nails screws hinges lace Sample Ret.

Timber type Sample Ret.

Interpretation / Comments

.....

db.

SITE 04R00	COFFIN RECORD SHEET	CONTEXT NO. 213
Trench:	Additional sheets: YES X1.	Treatment:
Site sub-div: NC	Grave fills	
Plan no: 3	Grave cut:	Finds None
Section no:	Skeleton:	Breastplate Grip
Co-ordinates:	Matrix location: Vault 110 under 114	Hinge Bracket
Levels	Preservation:	Fixing nails Shroud pins
Slide No.	Neg No:	Fabric Other finds
Description No coffin.		
Discussion		
Shape, dimensions and distinguishing characteristics		
LID		
HEAD		
BASE		
Recorder:	Date:	Initials:

Coffin Recording Sheet

Site Code

Context

Outer Coffin

Sample Ret.

OLC00

213

Recording Date 18/10

Associated Numbers

Condition

Dep. Plate

Legible

Inscription

Fabric lead ormolou brass tin plated pewter gilt tin
 iron silvered tin enamelled other Sample Ret.

Shape of dep. plate

square rectangle shield tapered lozenge
 cartouche oval other

Upholstery

colour shoddy velvet other *portion of combec punched (wce) interior fill.* Sample Ret.

Construction

butt joint mitred pitched other

Grip plate Fabric = ormolou brass tin plated pewter gilt tin
 iron silvered tin enamelled other Sample Ret.

Grip Fabric = ormolou brass iron x 1 Sample Ret.

Design swag of rose horseshoe cherub's head plain
 other *spttdo (A)*

Grip bolts Corner bolts Type = gilt brass brass iron
 other Sample Ret.

Lid motifs other Sample Ret.

Escutcheons other Sample Ret.

Upholstery nails brass gilt brass silvered brass iron enamelled
 other Sample Ret.

Fixings panel nails screws hinges lace Sample Ret.

Timber type Sample Ret.

Interpretation / Comments

.....

db.

SITE OLR00	COFFIN RECORD SHEET	CONTEXT NO. 214
Trench:	Additional sheets: YES x 1	Treatment: Bones collected.
Site sub-div: NC	Grave fills	
Plan no: 3	Grave cut:	Finds None
Section no:	Skeleton:	Breastplate Grip
Co-ordinates:	Matrix location:	Hinge Bracket
Levels	Preservation:	Fixing nails Shroud pins
Slide No.	Neg No:	Fabric Other finds :
Description Burial.		
Discussion		
Shape, dimensions and distinguishing characteristics		
LID		
HEAD		
BASE		
Recorder:	Date:	Initials:

Coffin Recording Sheet

Site Code

Context

Outer Coffin

Sample Ret.

OL200

21A

Recording Date 18/10

Associated Numbers

Condition

Dep. Plate

Legible

Inscription

Fabric lead ormolou brass tin plated pewter gilt tin
 iron silvered tin enamelled other Sample Ret.

Shape of dep. plate

square rectangle shield tapered lozenge
 cartouche oval other

Upholstery

colour shoddy velvet other Sample Ret.

Construction

butt joint mitred pitched other

Grip plate Fabric = ormolou brass tin plated pewter gilt tin
 iron silvered tin enamelled other Sample Ret.

Grip Fabric = ormolou brass iron ^{x2} ₍₃₀₎ Sample Ret.

Design swag of rose horseshoe cherub's head plain
 other

Grip bolts Corner bolts Type = gilt brass brass iron
 other Sample Ret.

Lid motifs other Sample Ret.

Escutcheons other Sample Ret.

Upholstery ^{shuds} nails brass gilt brass silvered brass iron ^{x2} _{2 pieces} enamelled
 other ^{1x ∞ / 1x ∞∞∞ = 6 in total.} Sample Ret.

Fixings panel nails screws hinges lace Sample Ret.

Timber type Sample Ret.

Interpretation / Comments

.....

SITE		COFFIN RECORD SHEET		CONTEXT NO.	
0LR00				215	
Trench:		Additional sheets:		Treatment: <i>Bones collected.</i>	
Site sub-div: <i>NC</i>		Grave fills			
Plan no: <i>3</i>		Grave cut:		Finds	
				None	
Section no:		Skeleton: <i>215</i>		Breastplate	
				Grip	
Co-ordinates:		Matrix location:		Hinge	
				Bracket	
Levels		Preservation: <i>partial skeleton only.</i>		Fixing nails	
				Shroud pins	
Slide No.		Neg No:		Fabric	
				Other finds	
Description					
<i>Amulated leg and foot bones only, rest of body truncated. Channel seen in overlying grave fill.</i>					
Discussion					
<i>Burial</i>					
Shape, dimensions and distinguishing characteristics					
<i>No coffin found</i>					
LID					
HEAD					
BASE					
Recorder: <i>JML</i>		Date: <i>12 9 2000</i>		Initials:	

db.

SITE 0LROO	COFFIN RECORD SHEET	CONTEXT NO. 216
Trench:	Additional sheets: YES x 1.	Treatment: Bones collected
Site sub-div: NC	Grave fills	
Plan no: 3	Grave cut:	Finds None
Section no:	Skeleton: <i>Good</i>	Breastplate Grip
Co-ordinates:	Matrix location:	Hinge Bracket
Levels	Preservation: <i>Skeleton good.</i>	Fixing nails Shroud pins
Slide No.	Neg No:	Fabric Other finds

Description
2 Burial in wooden coffin in a sequence one on top of another all seem to be in same grave cut.

Discussion
Burial

$$\begin{array}{r}
 217 \\
 | \\
 216 \\
 | \\
 218 \\
 \hline
 222 \quad 223 \quad 224 \\
 \hline
 226
 \end{array}$$

Shape, dimensions and distinguishing characteristics.

LID

HEAD

BASE

Recorder: <i>SML</i>	Date: <i>12 - 9 - 2000</i>	Initials:
----------------------	----------------------------	-----------

Coffin Recording Sheet

Site Code

Context

Outer Coffin

Sample Ret.

OK100

216

Recording Date 18/10

Associated Numbers

Condition

Dep. Plate

Legible

Inscription

Fabric lead ormolou brass tin plated pewter gilt tin
 iron silvered tin enamelled other Sample Ret.

Shape of dep. plate

square rectangle shield tapered lozenge
 cartouche oval other

Upholstery

colour shoddy velvet other Sample Ret.

Construction

butt joint mitred pitched other

Grip plate Fabric = ormolou brass tin plated pewter gilt tin
 iron silvered tin enamelled other Sample Ret.

Grip Fabric = ormolou brass iron x 1. Sample Ret.

frag of cartouche on rev. of grip: not enough to id.

(2a) intent grip ← = 0.10 ↓ = 0.04 plain

Design swag of rose horseshoe cherub's head other

Grip bolts **Corner bolts** Type = gilt brass brass iron

other Sample Ret.

Lid motifs other Sample Ret.

Escutcheons other Sample Ret.

Upholstery studs brass gilt brass silvered brass iron x 3 pieces enamelled

other 1x0 / 1x00 / 1x 88 / Sample Ret.

Fixings panel nails screws hinges lace Sample Ret.

Timber type Sample Ret.

Interpretation / Comments

.....

db.

SITE		COFFIN RECORD SHEET		CONTEXT NO.	
0LR00				217	
Trench:		Additional sheets: YES X 1.		Treatment: Bones collected	
Site sub-div: NO		Grave fills			
Plan no: 3		Grave cut:		Finds None	
Section no:		Skeleton:		Breastplate Grip <input checked="" type="checkbox"/>	
Co-ordinates:		Matrix location:		Hinge Bracket	
Levels		Preservation:		Fixing nails Shroud pins	
Slide No.		Neg No:		Fabric Other finds	
<p>Description: <i>uppermost of a sequence of coffins within same set of grave cut. packed one on top of the other.</i></p> <p>Discussion: <i>Burial</i></p> <div style="text-align: right;"> <p>217 216 218 195 222 223 224 226</p> </div>					
<p>Shape, dimensions and distinguishing characteristics</p> <p>LID</p> <p>HEAD</p> <p>BASE</p>					
Recorder: <i>JML</i>		Date: 12-9-2000		Initials:	

Site Code

Context

Outer Coffin

Sample Ret.

Orloo

217

Recording Date 26/9/00

Associated Numbers

Condition /

Dep. Plate

Legible

Inscription

Fabric lead ormolou brass tin plated pewter gilt tin
 iron silvered tin enamelled other Sample Ret.

Shape of dep. plate

square rectangle shield tapered lozenge
 cartouche oval other

Upholstery

colour shoddy velvet other Sample Ret.

Construction

butt joint mitred pitched other

Grip plate

Fabric = ormolou brass tin plated pewter gilt tin
Frogs on rev. of grip
 iron silvered tin enamelled other Sample Ret.

Grip

Fabric = ormolou brass iron 3
sm. subadult Sample Ret.

Design

swag of rose horseshoe cherub's head plain
 other *team to team = 0.10 ; deep = 0.04 m. v. conc.*

Grip bolts

Corner bolts Type = gilt brass brass iron

other Sample Ret.

Lid motifs

other Sample Ret.
X 3 Fe. plate frogs - dec. but unid.

Escutcheons

other Sample Ret.

Upholstery

shuds
nails brass gilt brass silvered brass iron *x 1. price* enamelled
 other *6 shuds in total*  Sample Ret.

Fixings

panel nails screws hinges lace Sample Ret.

Timber type

Sample Ret.

Interpretation / Comments

.....

db

SITE ULR00	COFFIN RECORD SHEET	CONTEXT NO. 218
Trench:	Additional sheets: YES x 1	Treatment: Bones collected
Site sub-div: NC	Grave fills	
Plan no: 3	Grave cut:	Finds None
Section no:	Skeleton:	Breastplate Grip
Co-ordinates:	Matrix location:	Hinge Bracket
Levels	Preservation: O.K.	Fixing nails Shroud pins
Slide No.	Neg No:	Fabric Other finds

Description
 lead coffin containing skeleton.
 Pale silty gk on bones, especially on face.

217
 |
 216
 |
 218

 222 223 224

 226

Discussion

Shape, dimensions and distinguishing characteristics

Lead coffin with a wooden one on inside & anchor on outside

LID

HEAD

BASE

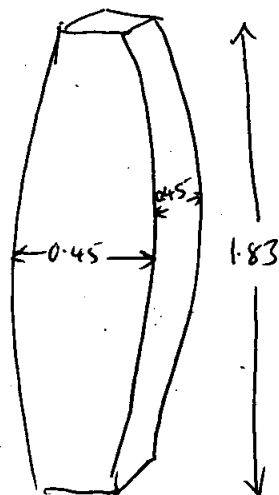

Recorder: SML	Date: 12. 9. 2000	Initials:
---------------	-------------------	-----------

Coffin Recording Sheet

Site Code

Context

Outer Coffin

Sample Ret.

OH100

218

Recording Date 18/10

Associated Numbers

Condition

Dep. Plate

Legible

Inscription

Fabric lead ormolou brass tin plated pewter gilt tin
 iron silvered tin enamelled other Sample Ret.

Shape of dep. plate

square rectangle shield tapered lozenge
 cartouche oval other

Upholstery

colour shoddy velvet other Sample Ret.

Construction

butt joint mitred pitched other

Grip plate Fabric = ormolou brass tin plated pewter gilt tin
 iron silvered tin enamelled other Sample Ret.

Grip Fabric = ormolou brass iron Sample Ret.

Design swag of rose horseshoe cherub's head plain
 other

Grip bolts Corner bolts Type = gilt brass brass iron

other Sample Ret.

Lid motifs other Sample Ret.

X 2 frags, fe, too conc. to id.

Escutcheons other Sample Ret.

Upholstery ^{studs} nails brass gilt brass silvered brass iron x 7 ^{pieces} enamelled
 other *5x strips of 3 + 1x 80 (1 Fe plate frag) + 1x 800 = 21 studs.* Sample Ret.

Fixings panel nails screws hinges lace Sample Ret.

Timber type Sample Ret.

Interpretation / Comments

.....

db-

SITE		COFFIN RECORD SHEET		CONTEXT NO.	
OLROU				219	
Trench:		Additional sheets:		Treatment:	
		YES x 1		Bones collected.	
Site sub-div:		Grave fills			
NC					
Plan no:		Grave cut:		Finds	
3				None	
Section no:		Skeleton:		Breastplate remains of.	
				Grip ✓	
Co-ordinates:		Matrix location:		Hinge	
				Bracket	
Levels		Preservation:		Fixing nails ✓	
				Shroud pins	
Slide No.		Neg No:		Fabric	
				Other finds	
Description					
Burial, just north of 218 and at same level as. Rem.					
Discussion					
Burial, skeleton in wooden coffin					
Shape, dimensions and distinguishing characteristics					
LID					
HEAD					
BASE					
Recorder:		Date:		Initials:	
SMC		12 9 2000			

Coffin Recording Sheet

Site Code

Context

Outer Coffin

Sample Ret.

OLR00

219

Recording Date 18/10

Associated Numbers

Condition

Dep. Plate

Legible

Inscription

frag of fe plate w/ borders - illegible & fragmentary, could be part of fe. dep. plate.

Fabric lead ormolou brass tin plated pewter gilt tin
 iron silvered tin enamelled other Sample Ret.

Shape of dep. plate

square rectangle shield tapered lozenge
 cartouche oval other

Upholstery

colour shoddy velvet other *Booze* Sample Ret.

Construction

butt joint mitred pitched other

Grip plate

Fabric = ormolou brass tin plated pewter gilt tin

iron silvered tin enamelled other Sample Ret.

fe. frag of cartouche on rev of grip

Grip

Fabric = ormolou brass iron *X4 small @'s* Sample Ret.

Design

swag of rose horseshoe cherub's head \uparrow 0.05 plain \leftrightarrow 0.12

other

Grip bolts

Corner bolts Type = gilt brass brass iron

other Sample Ret.

Lid motifs

other Sample Ret.

Escutcheons

other Sample Ret.

Upholstery *studs*

nails brass gilt brass silvered brass iron *X 2 single studs.* enamelled

other Sample Ret.

Fixings

panel nails screws hinges lace Sample Ret.

Timber type

Sample Ret.

Interpretation / Comments

.....

SITE <i>OLR00</i>	COFFIN RECORD SHEET		CONTEXT NO. <i>220</i>
Trench:	Additional sheets:	Treatment: <i>Bones collected</i>	
Site sub-div: <i>NL</i>	Grave fills		
Plan no: <i>3</i>	Grave cut:	Finds None	
Section no:	Skeleton:	Breastplate Grip	
Co-ordinates:	Matrix location:	Hinge Bracket	
Levels	Preservation: <i>partial skeleton</i>	Fixing nails Shroud pins	
Slide No.	Neg No:	Fabric Other finds	
<p>Description <i>Amulated leg bones + pelvis, no more bones found. Truncated by Burial 221. Under ledge 102</i></p> <p>Discussion <i>Burial consisting of an amulated leg + pelvis.</i></p> <div style="text-align: right; margin-right: 50px;"> <i>102 221 220</i> </div>			
<p>Shape, dimensions and distinguishing characteristics</p> <p>LID</p> <p>HEAD</p> <p>BASE</p>			
Recorder: <i>SML</i>	Date: <i>12. 9. 00.</i>	Initials:	

db.

SITE 02R00	COFFIN RECORD SHEET	CONTEXT NO. 221
Trench:	Additional sheets: YES x 1.	Treatment: Bones collected
Site sub-div: NC	Grave fills	
Plan no: 3	Grave cut:	Finds None
Section no:	Skeleton: 221	Breastplate Grip ✓
Co-ordinates:	Matrix location:	Hinge Bracket
Levels	Preservation: Fairly good	Fixing nails Shroud pins
Slide No.	Neg No:	Fabric Other finds shreds

Description . E-W orientated child burial under ledge 102

Discussion

102
221
1
220

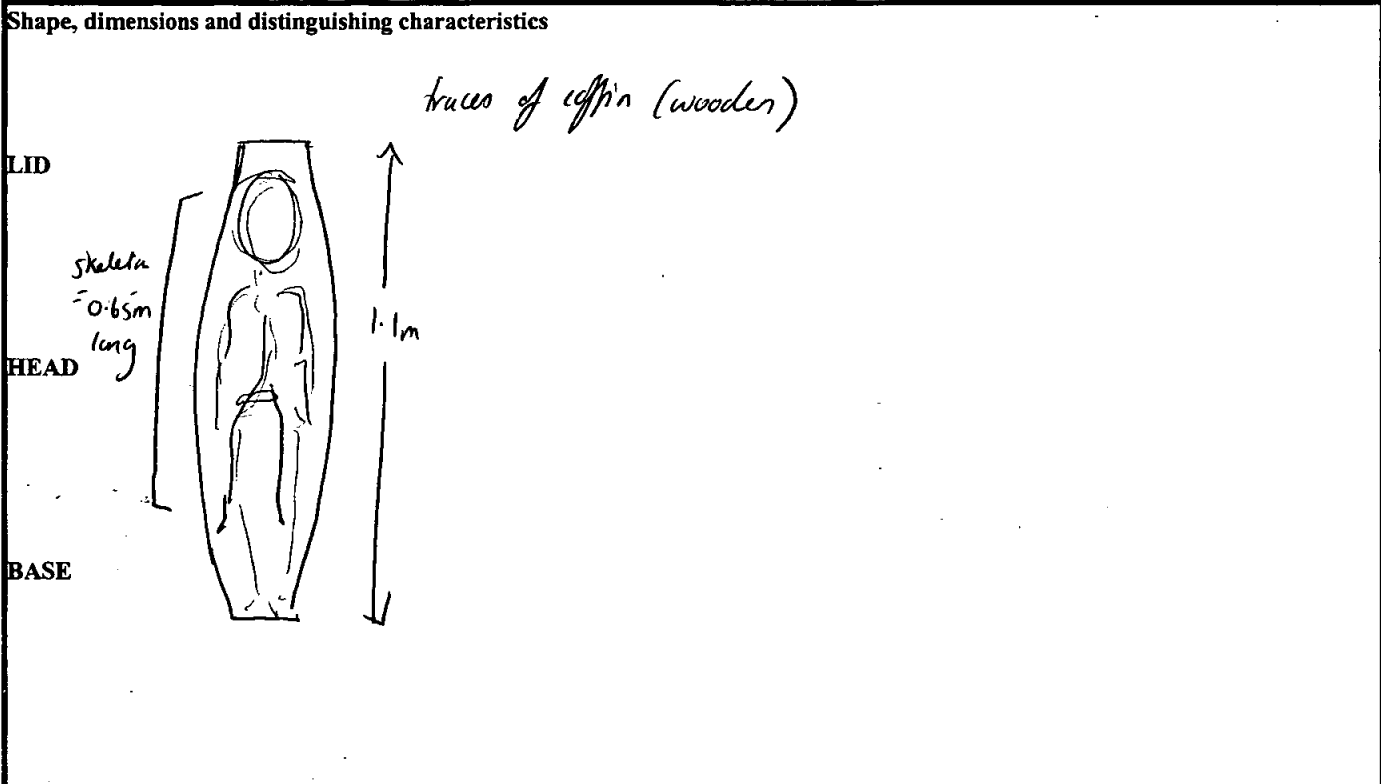

Recorder: gmu	Date: 12 9 2000	Initials:
------------------	--------------------	-----------

Coffin Recording Sheet

Site Code

Context

Outer Coffin

Sample Ret.

02200

221

Recording Date 18/10

Associated Numbers

Condition

Dep. Plate

Legible

Inscription

Fabric lead ormolou brass tin plated pewter gilt tin
 iron silvered tin enamelled other Sample Ret.

Shape of dep. plate

square rectangle shield tapered lozenge
 cartouche oval other

Upholstery

colour shoddy velvet other Sample Ret.

Construction

butt joint mitred pitched other

Grip plate Fabric = ormolou brass tin plated pewter gilt tin
 iron silvered tin enamelled other Sample Ret.
tags on lev. of grips.

Grip Fabric = ormolou brass iron Sample Ret.
intent grips \leftrightarrow 0.09
 ↓
 0.04 plain

Design

swag of rose horseshoe cherub's head other

Grip bolts Corner bolts Type = gilt brass brass iron

other Sample Ret.

Lid motifs other Sample Ret.

Escutcheons other Sample Ret.

Upholstery ^{studs} nails brass gilt brass silvered brass iron ^{peice} enamelled
 other = 00000 in total. Sample Ret.

Fixings panel nails screws hinges lace Sample Ret.

Timber type Sample Ret.

Interpretation / Comments

.....

Ab.

SITE	COFFIN RECORD SHEET	CONTEXT NO.
DLR 00		222
Trench:	Additional sheets: YES X1	Treatment: Bones collected
Site sub-div: NC	Grave fills /	
Plan no: 3	Grave cut: /	Finds None
Section no: -	Skeleton: 222	Breastplate Grip
Co-ordinates:	Matrix location:	Hinge Bracket
Levels	Preservation: not necessarily complete. a re-burial (mass)	Fixing nails Shroud pins
Slide No.	Neg No:	Fabric Other finds

Description A single small wooden coffin containing the bones of at least 3 individuals, ^{separately} not associated, & jumbled up together. The coffin is quite small & is in a family burial situation - a stack of 6 coffins on on top of another

Discussion Body / Skeleton

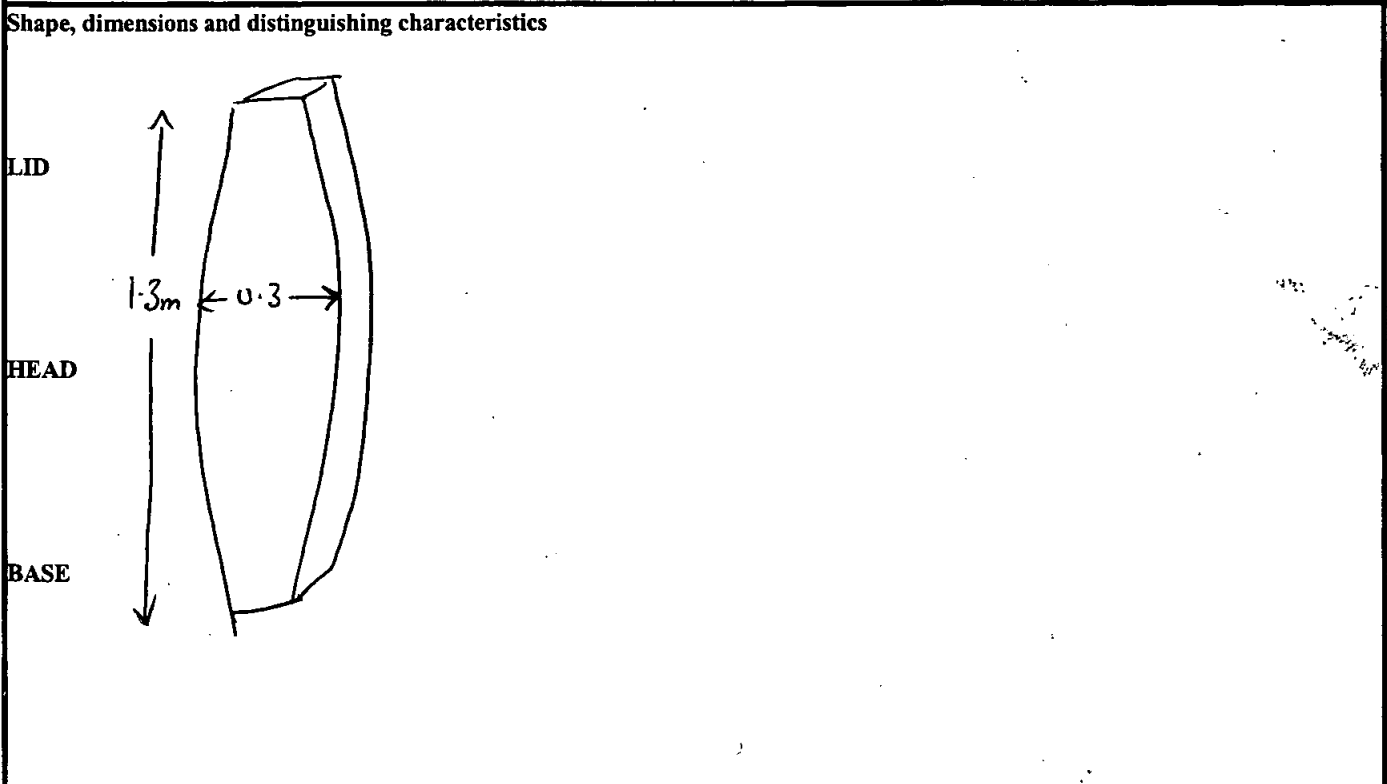

Recorder: *SM* Date: 12 9 00 Initials:

Outer Coffin

Sample Ret.

Site Code

Context

Recording Date 27/9/00

OLR00

222

Associated Numbers

Condition

Dep. Plate

Legible

Inscription

Fabric lead ormolou brass tin plated pewter gilt tin

iron silvered tin enamelled other Sample Ret.

Shape of dep. plate

square rectangle shield tapered lozenge

cartouche oval other

Upholstery

colour shoddy velvet other Sample Ret.

Construction butt joint mitred pitched other

Grip plate Fabric = ormolou brass tin plated pewter gilt tin

iron silvered tin enamelled other Sample Ret.

Grip Fabric = ormolou brass iron ~~X1~~ Sample Ret.

Design swag of rose horseshoe cherub's head plain

other *Spltds 30*

Grip bolts **Corner bolts** Type = gilt brass brass iron

other Sample Ret.

Lid motifs other Sample Ret.

Escutcheons other Sample Ret.

Upholstery ^{shuds} ~~nails~~ brass gilt brass silvered brass iron ^{pieces} enamelled

other *5 shuds in total* Sample Ret.

Fixings panel nails screws hinges lace Sample Ret.

Timber type Sample Ret.

Interpretation / Comments

.....

SITE <i>OLR00</i>	COFFIN RECORD SHEET	CONTEXT NO. <i>223</i>
Trench:	Additional sheets:	Treatment: <i>Bones collected</i>
Site sub-div: <i>NC</i>	Grave fills	
Plan no: <i>3</i>	Grave cut:	Finds None
Section no:	Skeleton: <i>223</i>	Breastplate Grip
Co-ordinates:	Matrix location:	Hinge Bracket
Levels	Preservation: <i>Good</i>	Fixing nails Shroud pins
Slide No.	Neg No:	Fabric Other finds
<p>Description <i>a small coffin (see 222) containing 223 skeleton + at least 2 other individuals (224 + 222). 3 skulls found + many long-bones</i></p>		
<p>Discussion <i>One of 3 bodies in one skeleton. coffin under 195 & over 226</i></p>		
<p>Shape, dimensions and distinguishing characteristics</p> <div style="text-align: center;"> </div> <p>LID</p> <p>HEAD</p> <p>BASE</p>		
Recorder: <i>JML</i>	Date: <i>12. 9. 00</i>	Initials:

SITE	COFFIN RECORD SHEET	CONTEXT NO.
OLR00		224
Trench:	Additional sheets:	Treatment: <i>Bones collected</i>
Site sub-div: <i>NC</i>	Grave fills <i>/</i>	
Plan no: <i>3</i>	Grave cut: <i>/</i>	Finds None
Section no:	Skeleton: <i>224</i>	Breastplate Grip
Co-ordinates:	Matrix location:	Hinge Bracket
Levels	Preservation: <i>Good, not necessarily complete</i>	Fixing nails Shroud pins
Slide No.	Neg No:	Fabric Other finds
Description <i>one of 3 bodies determined as individuals by skulls, within one small coffin i.e. a re-burial. not necessarily articulated.</i>		
Discussion <i>Disarticulated burial</i> <div style="text-align: center;"> </div>		
Shape, dimensions and distinguishing characteristics <i>See 222 for coffin description.</i>		
LID		
HEAD		
BASE		
Recorder: <i>DM</i>	Date: <i>12-9-2000</i>	Initials:

ADP

SITE OLR00	COFFIN RECORD SHEET	CONTEXT NO. 225
Trench:	Additional sheets: YES x1	Treatment: Bones collected with 196
Site sub-div: NC	Grave fills /	
Plan no: 3	Grave cut: /	Finds None
Section no:	Skeleton: 225	Breastplate <input checked="" type="checkbox"/> Grip
Co-ordinates:	Matrix location:	Hinge Bracket
Levels	Preservation: good, no coffin	Fixing nails Shroud pins
Slide No.	Neg No:	Fabric Other finds

Description
Skeleton hiked out with machine with another skeleton (196) and bagged up together.

Discussion
Rather deep section unsafe so not dug by hand.

Skeleton in coffin

196 225
227

Shape, dimensions and distinguishing characteristics

LID

HEAD

BASE

Readable Name plate found

Recorder: SMK	Date: 12. 9. 2000	Initials:
---------------	-------------------	-----------

Coffin Recording Sheet

Site Code

Context

Outer Coffin

Sample Ret.

OLR00

225

Recording Date 15/11/00

Associated Numbers

Condition

Dep. Plate

Legible

Inscription

Fabric lead ormolou brass tin plated pewter gilt tin
 iron silvered tin enamelled other Sample Ret.

Shape of dep. plate

square rectangle shield tapered lozenge
 cartouche oval other

Upholstery

colour shoddy velvet other Sample Ret.

Construction

butt joint mitred pitched other

Grip plate Fabric = ormolou brass tin plated pewter gilt tin
 iron silvered tin enamelled other Sample Ret.

Grip Fabric = ormolou brass iron x3 Sample Ret.

Design

swag of rose horseshoe cherub's head (4) 15 plain

other

Grip bolts Corner bolts Type = gilt brass brass iron

other Sample Ret.

Lid motifs other Sample Ret.

Escutcheons other Sample Ret.

Upholstery ^{studs} ~~nails~~ brass gilt brass silvered brass iron enamelled

other 1 peice ooooooo - 7 studs in total. Sample Ret.

Fixings panel nails screws hinges lace Sample Ret.

Timber type Sample Ret.

Interpretation / Comments

.....

boxed

SITE		COFFIN RECORD SHEET		CONTEXT NO.	
0LR00				226	
Trench:		Additional sheets: <i>YES x 1</i>		Treatment: <i>Bones collected excavated by machine</i>	
Site sub-div: <i>NC</i>		Grave fills: <i>/</i>			
Plan no: <i>3</i>		Grave cut: <i>/</i>		Finds	
				None	
Section no:		Skeleton: <i>226</i>		Breastplate	
				Grip x 2	
Co-ordinates:		Matrix location:		Hinge	
				Bracket	
Levels:		Preservation:		Fixing nails	
				Shroud pins	
Slide No.:		Neg No.:		Fabric	
				Other finds:	
Description <i>Body in wooden skeleton, situated at same level as just south of (196) + (225). Exc. by machine due to dangerous section.</i>					
Discussion					
Shape, dimensions and distinguishing characteristics					
LID					
HEAD					
BASE					
Recorder: <i>SMC</i>		Date: <i>12 9 2000</i>		Initials:	

Outer Coffin

Sample Ret.

Site Code

Context

Recording Date 21/9/00

OLR00

226

Associated Numbers

Condition

Dep. Plate

Legible

Inscription

Fabric lead ormolou brass tin plated pewter gilt tin
 iron silvered tin enamelled other Sample Ret.

Shape of dep. plate

square rectangle shield tapered lozenge
 cartouche oval other

Upholstery

colour shoddy velvet other Sample Ret.

Construction

butt joint mitred pitched other

Grip plate Fabric = ormolou brass tin plated pewter gilt tin
 iron silvered tin enamelled other Sample Ret.
frag. only.

Grip Fabric = ormolou brass iron **X2** Sample Ret.

Design

swag of rose horseshoe cherub's head plain
5 pths 1.

other

Grip bolts Corner bolts Type = gilt brass brass iron

other Sample Ret.

Lid motifs other Sample Ret.

Escutcheons other Sample Ret.

Upholstery nails brass gilt brass silvered brass iron enamelled

other Sample Ret.

Fixings panel nails screws hinges lace Sample Ret.

Timber type Sample Ret.

Interpretation / Comments

*fragments of grip plate on reverse of terminals -
 ferrous wood.*

db.

SITE <i>OLR00</i>	COFFIN RECORD SHEET	CONTEXT NO. <i>227</i>
Trench:	Additional sheets: <i>YES x 1</i>	Treatment: <i>Bones collected</i>
Site sub-div: <i>NC</i>	Grave fills <i>/</i>	<i>Machure occ.</i>
Plan no: <i>3</i>	Grave cut: <i>/</i>	Finds None
Section no:	Skeleton: <i>227</i>	Breastplate Grip
Co-ordinates:	Matrix location:	Hinge Bracket
Levels	Preservation:	Fixing nails Shroud pins
Slide No.	Neg No:	Fabric Other finds

Description *Burial underlying coffins 196 + 225* *196 225*
but not directly as it is further west than the latter *227*

Discussion *Burial in wooden coffin*

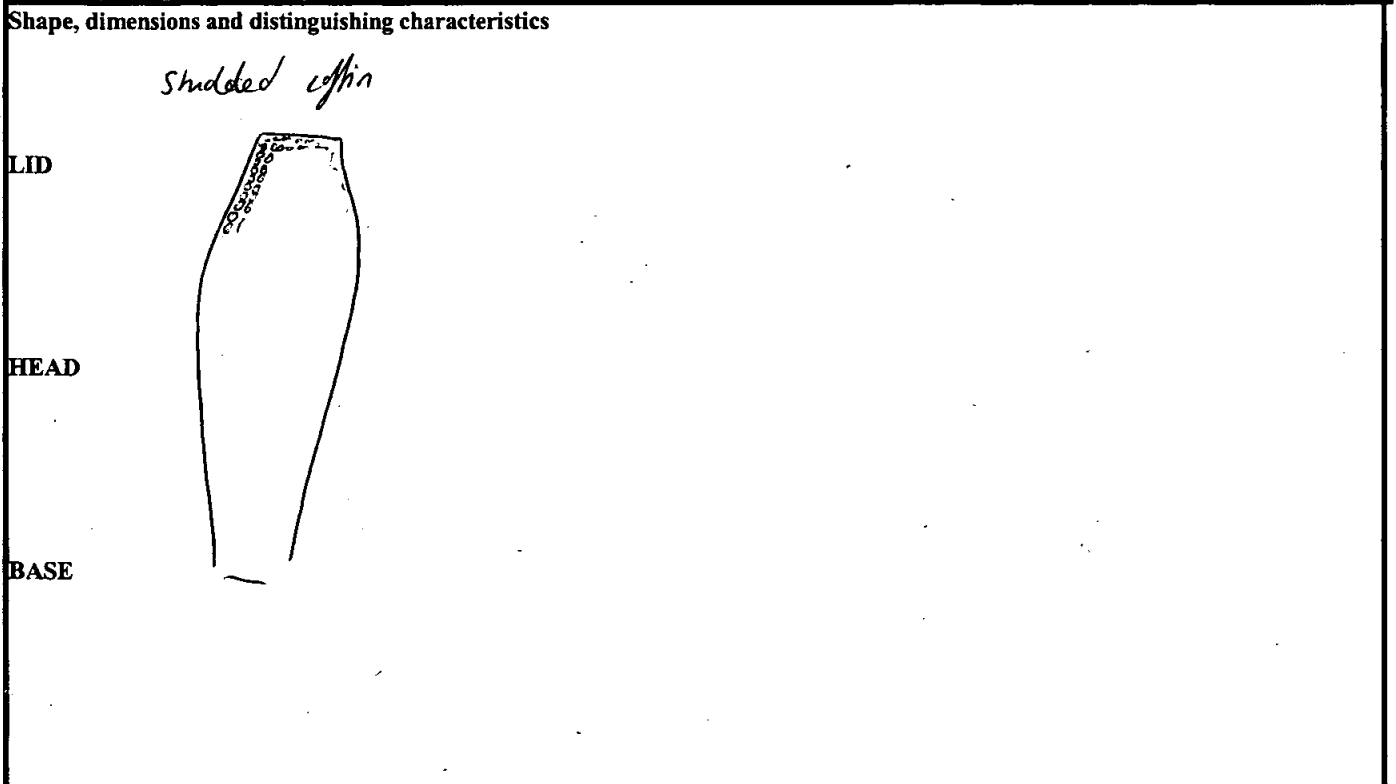

Recorder: <i>JML</i>	Date: <i>12.9.2000</i>	Initials:
-------------------------	---------------------------	-----------

Site Code

Context

OLK00

227

Outer Coffin

Sample Ret.

Recording Date 26/9/00

Associated Numbers

Condition

Dep. Plate

Legible

Inscription

Fabric lead ormolou brass tin plated pewter gilt tin
 iron silvered tin enamelled other Sample Ret.

Shape of dep. plate

square rectangle shield tapered lozenge
 cartouche oval other

Upholstery

colour shoddy velvet other *BATLE* Sample Ret.

Construction

butt joint mitred pitched other

Grip plate Fabric = ormolou brass tin plated pewter gilt tin
 iron silvered tin enamelled other Sample Ret.

Grip Fabric = ormolou brass iron *x1* Sample Ret.

Design swag of rose horseshoe cherub's head plain
 other *too badly conc. no returns or terminals - thick girth.*

Grip bolts Corner bolts Type = gilt brass brass iron
 other Sample Ret.

Lid motifs other Sample Ret.

Escutcheons other Sample Ret.

Upholstery ^{studs} ~~nails~~ brass gilt brass silvered brass iron enamelled
 other *1 x 000 | 1 x ~~888888~~ x 2 pieces Total of 11 studs* Sample Ret.

Fixings panel nails screws hinges lace Sample Ret.

Timber type Sample Ret.

Interpretation / Comments

.....

no.

SITE	COFFIN RECORD SHEET		CONTEXT NO.
01R00	Additional sheets: YES x2	228 Treatment: Bones collected	
Site sub-div: NC	Grave fills		
Plan no: 3	Grave cut:	Finds None	
Section no:	Skeleton:	Breastplate Grip	
Co-ordinates:	Matrix location:	Hinge Bracket	
Levels	Preservation:	Fixing nails Shroud pins	
Slide No.	Neg No:	Fabric Other finds: Some metal fittings	
Description: Skeleton with wooden coffin. Some fittings retrieved			
Discussion			
Shape, dimensions and distinguishing characteristics			
Recorder: SML. Date: 13. 9. 2000 Initials:			

Outer Coffin

Sample Ret.

Site Code

Context

On 100

228

Recording Date *26/9/00*

Associated Numbers

Condition

Dep. Plate

Legible

Inscription

Fabric lead ormolou brass tin plated pewter gilt tin
 iron silvered tin enamelled other Sample Ret.

Shape of dep. plate

square rectangle shield tapered lozenge
 cartouche oval other

Upholstery

colour shoddy *ferrous velvet* other Sample Ret.
attaching to fe. plate frag

Construction

butt joint mitred pitched other

Grip plate

Fabric = ormolou brass tin plated pewter gilt tin

iron silvered tin enamelled other Sample Ret.
x 1 complete + grip

Grip

Fabric = ormolou brass iron Sample Ret.
x 1 complete + plate + 3 frags

Design

swag of rose horseshoe cherub's head plain

other

Grip bolts

Corner bolts Type = gilt brass brass iron

other Sample Ret.

Lid motifs other

x 1 fe plate frag - dec - unid. Sample Ret.

Escutcheons other

Sample Ret.

Upholstery nails

brass gilt brass silvered brass iron enamelled

other Sample Ret.

Fixings

panel nails screws hinges lace Sample Ret.

Timber type

Sample Ret.

Interpretation / Comments

.....

db.

SITE		COFFIN RECORD SHEET		CONTEXT NO.	
02R00				229	
Trench:		Additional sheets:		Treatment: Bones collected	
Site sub-div: NC		Grave fills			
Plan no: 3		Grave cut:		Finds	
				None	
Section no:		Skeleton:		Breastplate	
				Grip	
Co-ordinates:		Matrix location:		Hinge	
				Bracket	
Levels		Preservation:		Fixing nails	
				Shroud pins	
Slide No.		Neg No:		Fabric	
				Other finds	
				:	
Description <i>Wooden coffin, bones retrieved in 2 different episodes of the same day. First right hand ^{leg} of body was retrieved from N. section face, later 2 skulls came from this area - both put into coffin.</i>					
Discussion <i>Skeleton in wood coffin. not complete, 2 heads.</i>					
Shape, dimensions and distinguishing characteristics					
LID					
HEAD					
BASE					
Recorder: <i>SML</i>		Date: <i>13. 9. 2000</i>		Initials:	

SITE	COFFIN RECORD SHEET		CONTEXT NO. 230
Trench: 04200	Additional sheets:	Treatment: Bones collected.	
Site sub-div: NC	Grave fills		
Plan no: 3	Grave cut:	Finds None	
Section no:	Skeleton:	Breastplate lead plate Grip / lead,	
Co-ordinates:	Matrix location:	Hinge Bracket	
Levels	Preservation: Good	Fixing nails Shroud pins	
Slide No.	Neg No:	Fabric Other finds Studs.	
Description Wooden coffin with lead name plate			
Discussion Body in NW corner.			
Shape, dimensions and distinguishing characteristics <div style="display: flex; justify-content: space-between;"> <div data-bbox="148 1411 196 1444">LID</div> <div data-bbox="148 1612 227 1646">HEAD</div> <div data-bbox="148 1814 227 1848">BASE</div> </div>			
Recorder: JML	Date: 13. 9. 2000	Initials:	

db .

SITE		COFFIN RECORD SHEET		CONTEXT NO.	
OLR00				231	
Trench:		Additional sheets:		Treatment: Bones collected with 232 Augeres.	
Site sub-div: NU		Grave fills			
Plan no: 3		Grave cut:		Finds None	
Section no:		Skeleton: 231		Breastplate Grip ✓	
Co-ordinates:		Matrix location:		Hinge Bracket	
Levels		Preservation:		Fixing nails Shroud pins	
Slide No.		Neg No:		Fabric Other finds brass studs	
Description Woodsen coffin with 2 skulls and at least 2 individuals present - all put into one bag under (231) & (232).					
Discussion 2 bodies? in one coffin, or one displaced extra skull.					
Shape, dimensions and distinguishing characteristics					
LID					
HEAD					
BASE					
Recorder: JMC.		Date: 13. 9. 2000		Initials:	

db.

SITE		COFFIN RECORD SHEET		CONTEXT NO.	
ULR 00				232	
Trench:		Additional sheets:		Treatment: Bones collected, will	
Site sub-div: NU		Grave fills		(231) in same bag.	
Plan no:		Grave cut:		Finds	
				None	
Section no:		Skeleton:		Breastplate	
				Grip <input checked="" type="checkbox"/>	
Co-ordinates:		Matrix location:		Hinge	
				Bracket	
Levels		Preservation:		Fixing nails	
				Shroud pins	
Slide No.		Neg No:		Fabric	
				Other finds brass studs	
<p>Description</p> <p>2 bones collected under numbers 231 + 232 from same coffin (seemingly). Coffin ^{was in} quite good condition for a wooden casket.</p> <p>Discussion</p> <p>furniture not retrieved / not seen by MR.</p>					
<p>Shape, dimensions and distinguishing characteristics</p> <p>LID</p> <p>HEAD</p> <p>BASE</p>					
Recorder: B.M.		Date: 13. 9. 2000		Initials:	

Islington, Old Street, St Lukes
OLROD

Box 2 File 4

B. PRIMARY CONTACT RECORDS - NO 233 - 364

SCAN PDF

FILMING INSTRUCTIONS

Submitter OASouth

No. of CD copies: 2

Headings

Site information

Line 1: [OASouth] County:[Greater London] Parish:[Islington] Site:[Old Street, St Lukes]

Site code[OLR00]

Line 2: Excavators name[A. Boyle]

Line 3:

Classification of material

Tick if present

Index to archive	
Introduction	
A:Final Report	
A:Publication Report	
B:Site Data – Text: Diary/Daybook/Fieldnotes	
B: Site Data – Text: General Summaries	
B: Site Data – Text: Primary Context Records <i>nº 233-364</i>	<input checked="" type="checkbox"/>
B: Site Data – Text: Synthesised Context Records	
B: Site Data – Text: Survey Reports	
B: Site Data – Text: Catalogue of Drawings	
B: Site Data – Text: Primary Drawings	
B: Site Data – Text: Synthesised Drawings	
C: Finds Data – Text: Primary Finds Data	
C: Finds Data – Text: Synthesised Finds Data	
C: Finds Data – Text: Specialist Reports	
C: Finds Data – Text: Box/Bag List	
D: Catalogue of Photos/Slides/Videos/X--rays	
E: Environmental/Ecofact Data: Primary Records	
E: Environmental/Ecofact Data: Synthesised Records	
E: Environmental/Ecofact Data: Specialist Reports	
F: Documentary	
F: Press and Publicity	
G: Correspondence	
H: Miscellaneous	

SITE		CONTEXT				SITE ST LUGES CHURCH,		
CODE: OLROO		CHECKLIST				NAME: ISLINGTON		
Context No	Type	Excavated with Segments	Relationships	Dug	Drawn		MATRIX MAILED?	Comments
					Section	Plan		
B	233	Burial	NC	over 234	8MCL		3	Burial (baby)
B	✓234	Burial	NC	under 233 over 236	8MCL		3	Burial
B	✓235	Burial	NC	over 237	8MCL		3	Burial.
B	✓236	Burial	NC	under 234	8MCL		3	lead coffin burial
B	✓237	Burial	NC	under 235	8MCL		3	child burial
	238	M STRUC	SC		DS		4	Reclumbant headstone
	239	M STRUC	SC		DS		4	Stone slab - ledger.
	240	M STRUC	CRYPT	bag 1	DS		5/7	Vault - Iron rail mgs revealed behind blockwork.
B	✓241	BURIAL	NC	over 242	DS		3	Burial
B	✓242	BURIAL	NC	over 243	DS		↓	Burial
B	✓243	BURIAL	NC	over 249	DS		↓	Burial
B	244	BURIAL	NC		DS		3	Burial.
B	245	BURIAL	NC		BF			Burial.
B	✓246	BURIAL	NC		BF			Burial
B	247	BURIAL	NC	} together	BF			Burial
B	248	BURIAL	NC		BF			
B	✓249	BURIAL	NC	over 250	BF			Burial
B	✓250	BURIAL	NC	under 249	BF		✓	Burial
	251	M STRUC	CRYPT	(Bag 1) ^{contains 253-255} ₂₄₃₋₂₄₅	DS		5/7	Vault. (6 pb coffins)
	✓252	BURIAL	NC		DS		3	Burial.
	253	BURIAL	CRYPT	[Vault 251] over 254	MJR		7	Y pb. coffin
DVA/B	254	BURIAL	CRYPT	under 253	MJR		7	Y pb. coffin
DVA/B	255	BURIAL	CRYPT	adj. to 254	MJR		7	Y pb. coffin
B	✓256	Burial	CRYPT	Bag 3 (W) over 336	DS/MR		7	Y p.b. coffin/infant
B	✓257	Burial	CRYPT	over 336	DS/MR		7	p.b. coffin/infant
DVA/B	✓258	Burial	CRYPT	over 336	DS/MR		7	Y p.b. coffin/infant
	259	Burial	CRYPT	over 336	DS/MR		7	Y p.b. coffin/infant
B	260	BURIAL	NC		DS		3	Burial
B	✓261	BURIAL	NC		DS		3	Burial
DVA/B	✓262	BURIAL	CRYPT	Bag 3 adj. to 263	MJR		7	Y lead coffin Burial
	263	BURIAL	CRYPT	adj. to 262 ie 264	↓		7	Y lead coffin - intact.
DVA/B	✓264	BURIAL	CRYPT	adj. to 263	↓		7	Y lead coffin Burial
B	✓265	BURIAL	NC		DS		3	Burial.

SITE		CONTEXT			SITE ST LUKES CHURCH			
CODE: OL200		CHECKLIST			NAME: ISLINGTON			
Context No	Type	Excavated with Segments	Relationships	Dug	Drawn		Matrix NAMED?	Comments
					Section	Plan		
B ✓ 266	BURIAL	NC	o/lies 268	SR/0H		3		Burial
B 267		NC	O/L BY 265 + o/lies 264			3		Burial
B 268		NC	O/L BY 266 266			3		Burial
B 269		NC	O/L BY 268 267	↓		3		Burial
- 270	BURIAL	CRYPT		DS		7		crushed lead coffin.
B ✓ 271	BURIAL	NC	NONE	DH		3		Burial
B ✓ 272	BURIAL	NC	NONE	↓				Burial
B ✓ 273	BURIAL	NC	WT INTO MAT.	↓		↓		Burial
B 274	BURIAL		O/L by 275 + o/lies 276 277					Burial in lead coffin.
B ✓ 275	BURIAL		O/Lies 274					Burial
B ✓ 276	BURIAL		O/L by 275					Burial. } Poss. mixing.
B ✓ 277	BURIAL		Lead with 276 O/L by 275					Burial. }
B ✓ 278	BURIAL		O/Lies 277					Burial } Poss. mixing
B ✓ 279	BURIAL		U/Lies 278					Burial }
B ✓ 280	BURIAL		NONE					Poss. mixing with Charnal.
DATA B 281	BURIAL		O/Lies 282				Y	Lead Coffin - Nameplate.
B ✓ 282	BURIAL		O/Lain by 281					Burial - good collection quality
B ✓ 283	BURIAL		O/Lies 284					Burial - child
DATA B 284	BURIAL		U/Lies 283				Y	Burial in ^{wood} coffin + nameplate
B 285	BURIAL		U/Lies 286					Burial - Trunc. by 286
B ✓ 286	BURIAL		O/Lies 285					Burial - child v. little remains.
B ✓ 287	BURIAL		O/Lies 284					Burial - child
B ✓ 288	BURIAL		O/Lies 284					Burial - child.
B 289	BURIAL		O/Lies 290					Burial - wood coffin.
B 290	BURIAL		O/Lies 291					Burial - wood + nameplate
B 291	BURIAL		O/L - 292 O/L - 290					Burial - wood + nameplate
B ✓ 292	BURIAL		O/L - 291					Baby - poss. truncating 291 etc
B ✓ 293	BURIAL		Assoc with 280 + 294					Baby / child
B ✓ 294	BURIAL		Assoc with 280 + 294					Baby / child
B ✓ 295	BURIAL		Trunc. by 297					Artic. skull 2 burials
B ✓ 296	BURIAL		Trunc. by 297					Artic. skull
B ✓ 297	BURIAL		Truncates 295 + 296					Burial.
B 298	BURIAL	✓	O/Lies 312	✓		✓		Burial.

BURIALS THIS SHEET = 33

SITE		CONTEXT				SITE		ST LUKE'S CHURCH	
CODE: OLLOO		CHECKLIST				NAME: ISLINGTON			
Context No	Type	Excavated with Segments	Relationships	Dug	Drawn		Matrix NAMED?	Comments	
					Section	Plan			
B 299	BURIAL	CRYPT		MYR		7		INTACT p.b. coffin.	
B 300	BURIAL	CRYPT		MYR		7	Y	INTACT p.b. coffin	
- 301	BURIAL	CRYPT	In vault 112 over 303	DS/MJR		7	Y	EMPTY	
- 302	BURIAL	CRYPT	over 304				Y	INTACT p.b. coffin	
B 303	BURIAL	CRYPT	under 301, 302, 304				Y	p.b. coffin	
DNAIB 304	BURIAL	CRYPT	under 302, adj. to 303				Y	p.b. coffin	
B 305	BURIAL	CRYPT	In vault 115 over 308	DS/MJR		7		p.b. coffin	
- 306	BURIAL	CRYPT	over 308					INTACT p.b. coffin	
DNAIB 307	BURIAL	CRYPT	over 302				Y	p.b. coffin	
- 308	BURIAL	CRYPT	under 306					INTACT p.b. coffin	
B 309	BURIAL	CRYPT	Bay 3	DS		7		lead coffin, displaced	
B 310	BURIAL	CRYPT	Bay 3					lead coffin, displaced.	
- 311	BURIAL	CRYPT	Bay 3					lead coffin - vandalised	
B 312	BURIAL	NC	o/lies 298 o/lies 316	DH		3		lead coffin + name.	
B 313	BURIAL		o/lies 314					Burial - wood coffin	
B 314	BURIAL		o/lies 314					Burial - wood coffin	
B 315	BURIAL		NONE					Skull + Jaw.	
B 316	BURIAL		o/l by 312					Burial - wood coffin	
B 317	BURIAL		NONE					TRUNCATED BY VAULT LOWER LEG + FEET ONLY.	
B 318	BURIAL		o/lies 368					Burial	
B 319	BURIAL		under 366 over 367					Burial	
B 320	BURIAL		o/lies 321					BURIAL	
B 321	BURIAL		o/lies 320					BURIAL	
B 322	BURIAL		o/lies 321					BURIAL	
B 323	BURIAL		legs trunc by 320 + 321					BURIAL	
B 324	BURIAL		o/lies 325					BURIAL - Baby.	
B 325	BURIAL		o/lies 324, 326					BURIAL - Juvenile	
B 326	BURIAL		o/lies 325					BURIAL - Baby/child	
B 327	BURIAL		Poss. trunc. by 328					BURIAL	
B 328	BURIAL		Poss. truncating 327					BURIAL	
B 329	BURIAL		Truncates 330					BURIAL	
B 330	BURIAL		Trunc. by 329					BURIAL	
B 331	BURIAL	▽	NONE	▽		▽		BURIAL	

BURIALS THIS SHEET = 33

SITE CODE: OLROO		CONTEXT CHECKLIST				SITE ST LUKES CHURCH NAME: ISLINGTON		
Context No	Type	Excavated with Segments	Relationships	Dug	Drawn		Matrix NAMED?	Comments
					Section	Plan		
332	LOWER STRUC	S.C.	under modern Pathway	DS		4		old paved churchyard Path to SE door of church.
333	Burial	Crypt	in Boy 3 (w) OVER 335	DS/MR		7	Y	intact infant pb
334	Burial	Crypt	over 335	DS/MR		7	Y	Intact infant pb
335	Burial	Crypt	under 334 & 333	DS/MR		7	Y	intact adult p.b.
336	Burial	Crypt	under 236; 257; 258; 259	DS/MR		7	Y	intact adult p.b.
337	Burial	Crypt	in vault 11	DS/MR		7	Y	intact infant pb
338	Burial	Crypt	Boy 3	DS/MR		7	Y	p.b. coffin
339	Burial	Crypt	in vault 17 over 340	DS/MR		7	Y	p.b. coffin - trig
340	Burial	Crypt	under 339	DS/MR		7	Y	intact p.b. coffin
341	Burial	Crypt	under 340	DS/MR		7	Y	wooden coffin.
342	Burial	Crypt	in vault 15 under 307	DS/MR		7	Y	intact adult p.b.
343	Burial	Crypt	under 305	DS/MR		7	Y	p.b. coffin
344	Burial	Crypt	under 308	DS/MR		7	Y	intact infant p.b.
345	Burial	N.C.	bagged as part of 243	DS		3		2 individuals in 1 bag - assoc. w/ 243.
346	Burial	N.C.	bagged as part of 228	SML		3		2 individuals in 1 bag - assoc. w/ 228.
347	Burial	N.C.	bagged with 222, 223	SML		3		in w/ 222/223/224
348	Burial	N.C.	224 - moss	SML		3		in w/ 222/223/224
349	Burial	N.C.	reburied in coffin 222	SML		3		in w/ 222/223/224
350	Burial	Crypt	in vault 13	MR/DS		7	Y	p.b. coffin - skull destroyed.
351	Burial	Crypt	in Boy 3	MR/DS		7		p.b. coffin
352	Burial	Crypt		MR/DS		7	Y	p.b. coffin
353	Burial	Crypt		MR/DS		7	Y	p.b. coffin
354	Burial	Crypt		MR/DS		7		p.b. coffin
355	Burial	Crypt		MR/DS		7	Y	p.b. coffin
356	Burial	Crypt		MR/DS		7	Y	p.b. coffin
357	Burial	Crypt		MR/DS		7		p.b. coffin.
358	LAYER	N.C.	under 205	DS	10			Part NATURAL Brickwork?
359	Burial	Crypt	In Boy 3	MR/DS		7		2 in coffin
360	Burial	Crypt	under 358	MR/DS		7	Y	p.b. coffin
361	Burial	Crypt	in vault 12 over 303	MR/DS		7	Y	p.b. coffin
362	Burial	Crypt	in vault 16 over 363	MR/DS		7	Y	p.b. coffin
363	Burial	Crypt	under 362	MR/DS		7	Y	p.b. coffin
364	Burial	Crypt	under 465 & 466	MR/DS		7	Y	p.b. coffin.

BURIALS THIS PAGE = 31

add to list

SITE	COFFIN RECORD SHEET		CONTEXT NO.
02R00	Additional sheets:	233	
Trench:	Grave fills	Treatment: <i>Bones collected</i>	
Site sub-div: <i>NC</i>	Grave cut:	Finds	
Plan no: <i>3</i>	Skeleton:	None	
Section no:	Matrix location:	Breastplate	
Co-ordinates:	Preservation:	Grip <input checked="" type="checkbox"/>	
Levels	Slide No.:	Hinge	
Slide No.	Neg No:	Bracket	
Description		Fixing nails	
Discussion		Shroud pins	
Shape, dimensions and distinguishing characteristics		Fabric	
LID		Other finds	
HEAD			
BASE			
Recorder: <i>SMC</i>	Date: <i>13. 9. 2000</i>	Initials:	

Powdery skeleton - only a skull fragment returned because the rest turned to dust. Coffin shape was in good condition.

Baby burial.

d.b.

SITE		COFFIN RECORD SHEET	CONTEXT NO.
OLR00			234
Trench:		Additional sheets: YES x 2.	Treatment: Bones collected
Site sub-div:	NC	Grave fills	
Plan no:	3	Grave cut:	Finds None
Section no:		Skeleton:	Breastplate Grip
Co-ordinates:		Matrix location:	Hinge Bracket
Levels		Preservation:	Fixing nails Shroud pins
Slide No.		Neg No:	Fabric Other finds

Description
 Wooden coffin containing skeleton,
 retrieved by hand - underlying baby coffin & overlying
 the possible shadow of another small coffin but unsure - disappeared
 & may have been part of 236.

Discussion
 Coffin + body.

233
 1
 234
 shadow of baby coffin underneath
 fragmentary - not recorded
 236

Shape, dimensions and distinguishing characteristics

LID

HEAD

BASE

Recorder: SMU.	Date: 13. 7. 00	Initials:
----------------	-----------------	-----------

Coffin Recording Sheet

Outer Coffin

Sample Ret.

Site Code

Context

Recording Date 21/9/00

OLR00

234

Associated Numbers under 233

Condition Poor

Dep. Plate

Legible

Inscription

Fabric lead ormolou brass tin plated pewter gilt tin
 iron silvered tin enamelled other Sample Ret.

Shape of dep. plate

square rectangle shield tapered lozenge
 cartouche oval other

Upholstery

colour shoddy velvet other Sample Ret.

Construction

butt joint mitred pitched other

Grip plate Fabric = ormolou brass tin plated pewter gilt tin
 iron 2 x flags silvered tin enamelled other Sample Ret.

Grip Fabric = ormolou brass iron x2 Sample Ret.

Design

swag of rose horseshoe cherub's head plain

other

Grip bolts Corner bolts Type = gilt brass brass iron

other Sample Ret.

Lid motifs other

Sample Ret.

Escutcheons other

Sample Ret.

Upholstery nails brass gilt brass silvered brass iron enamelled

other Sample Ret.

Fixings panel nails screws hinges lace Sample Ret.

Timber type Sample Ret.

Interpretation / Comments

.....

grips: 1 w/ fe. plate frags on rev. - partial small oval
 concave; v. badly concasted. Grips are small & similar
 to Spttds 2a. Most complete one measures
 0.13 m from terminal to terminal w/ drop of c. 0.05 m.

plate: Flatish frag of dec plate maybe from grip plate or lid motif.
 fe. with  visible on rev. so viewed from obverse
 would appear as sunken relief. c. 0.05 x 0.035 m.

up. studs: fe; 5 x frags - 3 of which are single row lengths
 the other 2 being groups of 4 studs conc. to nails.

strip a) - 5 x studs
 strip b) - 3 x studs
 strip c) - 6 x studs.

nail a) - 

nail b) -  - poss. corner
 piece.

d.b.

SITE		COFFIN RECORD SHEET		CONTEXT NO.	
ORL00				235	
Trench:		Additional sheets: YES x 2		Treatment: Bones collected	
Site sub-div: NL		Grave fills		with machine.	
Plan no: 3		Grave cut:		Finds	
				None	
Section no:		Skeleton:		Breastplate	
				Grip	
Co-ordinates:		Matrix location:		Hinge	
				Bracket	
Levels		Preservation:		Fixing nails	
				Shroud pins	
Slide No.		Neg No:		Fabric	
				Other finds	
				:	
Description					
Body see found in N. edge of excavation. unsafe: machined & collected from bucket					
Discussion					
235 1 237 - child burial					
Shape, dimensions and distinguishing characteristics					
LID					
HEAD					
BASE					
Recorder: JML.		Date: 13. 9. 00.		Initials:	

Coffin Recording Sheet

Site Code

Context

Outer Coffin

Sample Ret.

OLR00

235

Recording Date 21/9/00

Associated Numbers

Condition Pool.

Dep. Plate

Legible

Inscription

Fabric lead ormolou brass tin plated pewter gilt tin
 iron silvered tin enamelled other Sample Ret.

Shape of dep. plate

square rectangle shield tapered lozenge
 cartouche oval other

Upholstery

colour shoddy velvet other Sample Ret.

Construction

butt joint mitred pitched other

Grip plate Fabric = ormolou brass tin plated pewter gilt tin
 iron ~~Fe~~ silvered tin enamelled other Sample Ret.

Grip Fabric = ormolou brass iron x 3 Sample Ret.

Design swag of rose horseshoe cherub's head plain
 other

Grip bolts Corner bolts Type = gilt brass brass iron
 other Sample Ret.

Lid motifs ? other Sample Ret.

Escutcheons ? other Sample Ret.

} dec. plate - Fe.

Upholstery ^{studs} nails brass gilt brass silvered brass iron enamelled
 other Sample Ret.

Fixings panel nails screws hinges lace Sample Ret.

Timber type Sample Ret.

Interpretation / Comments

.....

Fe. nails x 6.

Grips: x 3 - infant grips, 2 w/ frags of Fe. grip plate
conc. to reverse - visible dec. in form of sketch below.



From most complete example
measurements are as follows:
terminal to terminal = 0.09 m
drop = c. 0.04 m.

Up. studs: strip of 4; Fe.

Dec. plate: 2 x frags; one of which is the corner of a bordered
plaque-type plate (see sketch below) w/ ferrous fabric
adhering to rev-course weave. Other unident.

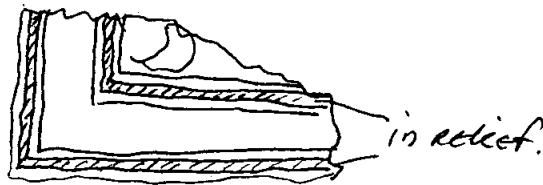

d.p.

SITE		COFFIN RECORD SHEET		CONTEXT NO.	
02000 02000				236	
Trench:		Additional sheets:		Treatment: Bones collected.	
Site sub-div: NC		Grave fills			
Plan no: 3		Grave cut:		Finds	
				None	
Section no:		Skeleton:		Breastplate	
				Grip ✓	
Co-ordinates:		Matrix location:		Hinge	
				Bracket	
Levels		Preservation:		Fixing nails	
				Shroud pins	
Slide No.		Neg No:		Fabric ✓	
				Other finds	
Description		Intact skeleton within almost perfect but perforated lead coffin.		233 1 234 1 236 1	
Discussion		skeleton in lead coffin. In sequence of →			
Shape, dimensions and distinguishing characteristics					
lead coffin with wood outer coffin & anchor wooden lid under the lead, covering body.					
LID					
HEAD					
BASE					
Recorder: SM.		Date: 13. 9. 00		Initials:	

Outer Coffin

Sample Ret.

Site Code

Context

Recording Date 19/9

06200

236

Associated Numbers

Condition Poor

Dep. Plate

Legible

Inscription

Fabric lead ormolou brass tin plated pewter gilt tin
 iron silvered tin enamelled other Sample Ret.

Shape of dep. plate

square rectangle shield tapered lozenge
 cartouche oval other

Upholstery

colour shoddy velvet other Sample Ret.

Construction butt joint mitred pitched other

Grip plate Fabric = ormolou brass tin plated pewter gilt tin
 iron silvered tin enamelled other Sample Ret.

Grip Fabric = ormolou brass iron Sample Ret.

Design swag of rose horseshoe cherub's head plain
 other *poor/plain sptfdo*

Grip bolts **Corner bolts** **Type =** gilt brass brass iron

other Sample Ret.

Lid motifs other Sample Ret.

Escutcheons other Sample Ret.

Upholstery nails brass gilt brass silvered brass iron enamelled
 other Sample Ret.

Fixings panel nails screws hinges lace Sample Ret.

Timber type Sample Ret.

Interpretation / Comments

..... *upholstery can be implied by presence of*
 *fe. up. stud.*

db.

SITE		COFFIN RECORD SHEET		CONTEXT NO.	
0LR00				237	
Trench:		Additional sheets: YES x 1		Treatment: Bones collected.	
Site sub-div: NC		Grave fills			
Plan no: 3		Grave cut:		Finds	
				None	
Section no:		Skeleton:		Breastplate	
				Grip <input checked="" type="checkbox"/>	
Co-ordinates:		Matrix location:		Hinge	
				Bracket	
Levels		Preservation:		up studs <input checked="" type="checkbox"/>	
				Fixing nails <input checked="" type="checkbox"/>	
Slide No.		Neg No:		Shroud pins	
				Fabric	
				Other finds Bronze ring (in green box)	
Description		Small wooden coffin at bottom of family grave.		235 237 Base of excavation. no more graves.	
Discussion		Child burial.			
Shape, dimensions and distinguishing characteristics					
LID					
HEAD					
BASE					
Recorder: PML.		Date: 13. 9. 2000		Initials:	

Site Code

Context

Outer Coffin

Sample Ret.

02R00

237

Recording Date 22/9/00

Associated Numbers

Condition 1

Dep. Plate

Legible

Inscription

Fabric lead ormolou brass tin plated pewter gilt tin
 iron silvered tin enamelled other Sample Ret.

Shape of dep. plate

square rectangle shield tapered lozenge
 cartouche oval other

Upholstery

colour shoddy velvet other Sample Ret.

Construction

butt joint mitred pitched other

Grip plate Fabric = ormolou brass tin plated pewter gilt tin
 iron silvered tin enamelled other Sample Ret.

Grip Fabric = ormolou brass iron Sample Ret.

Design swag of rose horseshoe cherub's head plain

other *from terminal to break @ centre of grip = 0.06, estm. deep = 0.04*

Grip bolts Corner bolts Type = gilt brass brass iron

other Sample Ret.

Lid motifs other Sample Ret.

Escutcheons other Sample Ret.

Upholstery nails brass gilt brass silvered brass iron 3 pieces enamelled

other *3 strips - a) x 3 b) x 3 c) x 2 = total studs 8* Sample Ret.

Fixings panel nails screws hinges lace Sample Ret.

Timber type Sample Ret.

Interpretation / Comments

.....

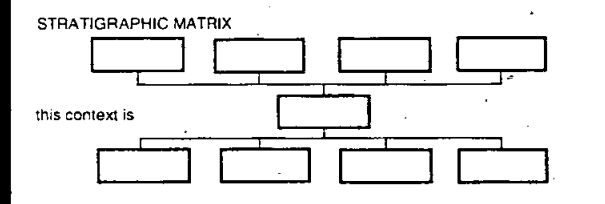
SITE	CONTEXT RECORD	Context No.
OLR00	Additional Sheets:	238
Trench	Context Type: Deposit / Cut / <u>Structure</u>	Type STRUC
Site sub-div S.C.	Overlain by:	Check Lists:
Structure No.	Abuted by:	DEPOSIT:
Plan No. 4	Cut by:	1.compaction 2.colour 3.composition 4.inclusions 5.thickness 6.extent 7.comments 8.method & conditions
	Filled by:	CUT:
Section No.	Same as:	1.shape in plan 2.base/sides/top profile 3.dimension and depth 4.sketch 5.truncation 6.fill nos 7.other comments
Co-Ordinates	Part of:	MASONRY:
	Consists of:	1.materials 2.size of bricks etc 3.finish of stones 4.coursing/bond 5.form 6.faces 7.bond 8.dimensions as found 9.other comments
	Overlies:	
Level	Butts:	
Slide No.	Cuts:	
Neg No.	Fill of:	
Matrix location	Relationships uncertain	
Description (See check lists):		STRATIGRAPHIC MATRIX 
Slate recumbent headstone.		
1.90 x 0.92 x 0.15m		
Inscription:- In memory of Mrs		
JOHANNAH WATTS, who died 6 Jan 1810 Aged 73 years, ROSEANNA		
CHISLETT, daughter of the above & wife of ISAAC CHISLETT Junr died		
Nov 27 th 1812 in her 37 th year. JOHN CHISLETT died April 14 th 1825		
Aged 20 years. ELEANOR CHISLETT, died April 4 th 1832 Aged 57 years. ISAAC		
Interpretation/Discussion: CHISLETT died Feb 12 th 1851 aged 76 years.		
<u>Recumbent headstone.</u>		
Finds (tick): None <input type="checkbox"/> Pot <input type="checkbox"/> Bone <input type="checkbox"/> Flint <input type="checkbox"/> Stone <input type="checkbox"/> Burnt stone <input type="checkbox"/> Glass <input type="checkbox"/> Metal <input type="checkbox"/>		
CBM <input type="checkbox"/> Wood <input type="checkbox"/> Leather <input type="checkbox"/>		
ΔSmall Finds	Recorder DS	
◇Samples	Date 14/1	
△Building Materials	Initials	

SITE		CONTEXT RECORD		Context No.
0L200		Additional Sheets:		239
Trench	Context Type: Deposit / Cut / <u>Structure</u>			Check Lists:
Site sub-div	SC	Overlain by:	DEPOSIT:	
Structure No.		Abutted by:	1.compaction 2.colour	
Plan No.	4	Cut by:	3.composition	
Section No.		Filled by: <u>Back of 809 & local coff: 15 808 & 807</u>	4.inclusions 5.thickness	
Co-Ordinates		Same as:	6.extent 7.comments	
Level		Part of:	8.method & conditions	
Slide No.		Consists of:	CUT:	
Neg No.		Overlies:	1.shape in plan	
Matrix location		Butts:	2.base/sides/top profile	
Description (See check lists):		Cuts:	3.dimension and depth	
<p>Stone slab 1.90 x 0.95 x 0.08m (the top of a battle tomb - smooth finish with beveled edge.)</p>		Fill of:	4.sketch 5.truncation	
		Relationships uncertain	6.fill nos 7.other comments	
		Relationships uncertain	MASONRY:	
			1.materials 2.size of bricks etc 3.finish of stones 4.coursing/bond	
			5.form 6.faces 7.bond	
			8.dimensions as found	
			9.other comments	
			STRATIGRAPHIC MATRIX 	
<p>over 2nd slab 1.80 x 0.90 x 0.08m</p>			Covers bich grave with	
<p>interior dimensions 2.30 x 0.80m and 2.80m deep.</p>			bich walls are 0.30m thick. Contains burial 809 below	
<p>local coffins 808 & 807</p>				
Interpretation/Discussion:			2x <u>Stone Slab</u> - monument base?	
Finds (tick): None <input type="checkbox"/> Pot <input type="checkbox"/> Bone <input type="checkbox"/> Flint <input type="checkbox"/> Stone <input type="checkbox"/> Burnt stone <input type="checkbox"/> Glass <input type="checkbox"/> Metal <input type="checkbox"/> CBM <input type="checkbox"/> Wood <input type="checkbox"/> Leather <input type="checkbox"/>				
ΔSmall Finds			Recorder DS	
◇Samples			Date 14/9	
ΔBuilding Materials			Initials	

SITE OLR00		CONTEXT RECORD		Context No. 240
Trench		Additional Sheets:		Type STRUCTURE
Site sub-div CRYPT	Context Type: Deposit / Cut / Structure	Check Lists:		
Structure No.	Overlain by:	DEPOSIT:		
Plan No. 5 / 7	Abutted by:	1.compaction 2.colour 3.composition 4.inclusions 5.thickness 6.extent 7.comments 8.method & conditions		
Section No.	Cut by:	CUT:		
Co-Ordinates	Filled by:	1.shape in plan 2.base/sides/top profile 3.dimension and depth 4.sketch 5.truncation 6.fill nos 7.other comments		
Level	Same as:	MASONRY:		
Slide No.	Part of:	1.materials 2.size of bricks etc 3.finish of stones 4.coursing/bond 5.form 6.faces 7.bond 8.dimensions as found 9.other comments		
Neg No.	Consists of: COFFINS 725-728 & 762-764			
Matrix location	Overlies:			
	Butts:			
	Cuts:			
	Fill of:			
	Relationships uncertain			
Description (See check lists):		STRATIGRAPHIC MATRIX		
Vault - 2.20 x 1.60m framed of iron railings with 'spear' tops, set on stone kerbs c. 0.30m above floor of Bay 1 of crypt. Corner railings set into roof of crypt - railing shaped to follow curve of crypt arch. Front $\rightarrow \frac{1}{2}$ is a hinged door with 2 locks & a plaque - iron - inscription: - "The Family Vault of John Gardner, City Road". This vault enclosed by single skin breeze block wall.				
Interpretation/Discussion:				
Vault with iron railings revealed behind latter block wall in Bay 1 of crypt. presumably blocked in when Bay 1, plastered/decorated for alternative use. Initially no coffins visible \rightarrow but excavation below level of Bay 1 floor revealed coffins (CONTAINED) COFFINS 725-728 AND 762-764. 762 HAD VAULT WALL AND WAS BUILT OVER IT - see loss. 762-764 WERE BUILT WITHIN LARGER CUT & THEN VAULT CONSTRUCTED AT LATER DATE?				
Finds (tick): None <input type="checkbox"/> Pot <input type="checkbox"/> Bone <input type="checkbox"/> Flint <input type="checkbox"/> Stone <input type="checkbox"/> Burnt stone <input type="checkbox"/> Glass <input type="checkbox"/> Metal <input type="checkbox"/> CBM <input type="checkbox"/> Wood <input type="checkbox"/> Leather <input type="checkbox"/>				
Small Finds			Recorder: DS	
Samples			Date 15/9	
Building Materials			Initials	

db.

SITE OLR 00		COFFIN RECORD SHEET		CONTEXT NO. 241	
Trench:		Additional sheets:		Treatment: Bones collected	
Site sub-div: NC		Grave fills			
Plan no: 3		Grave cut:		Finds None	
Section no: -		Skeleton: Arms at sides		Breastplate Grip	
Co-ordinates:		Matrix location: over 242 (241, 242 243 - in same grave location)		Hinge Bracket	
Levels		Preservation:		Fixing nails Shroud pins	
Slide No.		Neg No:		Fabric Other finds	
Description					
Discussion					
Shape, dimensions and distinguishing characteristics					
LID					
HEAD					
BASE					
Recorder: DS		Date: 14/9		Initials:	

db.

SITE	COFFIN RECORD SHEET		CONTEXT NO.
02R00	Additional sheets: YES X 2	242 Treatment: Bones collected	
Trench:	Grave fills		
Site sub-div: NC	Grave cut:	Finds None	
Plan no: 3	Skeleton: Arms at sides	Breastplate Grip	
Section no:	Matrix location: over 243	Hinge Bracket up studs	
Co-ordinates:	Preservation:	Fixing nails ✓ Shroud pins	
Levels	Neg No:	Fabric Other finds	
Slide No.			
Description			
Discussion			
Shape, dimensions and distinguishing characteristics			
LID HEAD BASE			
Recorder: SS	Date: 14/9	Initials:	

Coffin Recording Sheet

Site Code

Context

Outer Coffin

Sample Ret.

OLR00

242

Recording Date 21/9/00

Associated Numbers

Condition /

Dep. Plate

Legible

Inscription

Fabric lead ormolou brass tin plated pewter gilt tin
 iron silvered tin enamelled other Sample Ret.

Shape of dep. plate

square rectangle shield tapered lozenge
 cartouche oval other

Upholstery

colour shoddy velvet other Sample Ret.

Construction

butt joint mitred pitched other

Grip plate Fabric = ormolou brass tin plated pewter gilt tin
 iron silvered tin enamelled other Sample Ret.

Grip Fabric = ormolou brass iron Sample Ret.

Design swag of rose horseshoe cherub's head plain

other

Grip bolts Corner bolts Type = gilt brass brass iron

other Sample Ret.

Lid motifs other Sample Ret.

Escutcheons other Sample Ret.

Upholstery ^{studs} nails brass gilt brass silvered brass iron ^{x4 STRIPS.} enamelled

other Sample Ret.

Fixings panel nails screws hinges lace Sample Ret.

Timber type Sample Ret.

Interpretation / Comments

.....

Fe. Up. studs: x 4 strips. w/ ferrous wood

- a) x 4 studs c. 0.055 m
- b) x 7 studs c. 0.11 m
- c) x 13 studs c. 0.21 m
- d) x 14 studs

} single length strips.

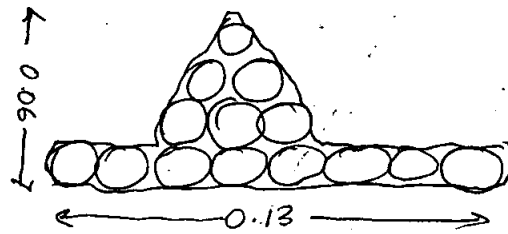

poss. part of
 Studs 3/4/7/11 etc.

db

SITE OLROD		COFFIN RECORD SHEET		CONTEXT NO. 243	
Trench:		Additional sheets: YES X1		Treatment: Bones collected.	
Site sub-div: NC		Grave fills			
Plan no: 3		Grave cut:		Finds None	
Section no:		Skeleton: Arms at sides.		Breastplate Grip	
Co-ordinates:		Matrix location: over 249 but 249 separate grave.		Hinge Bracket	
Levels		Preservation:		Fixing nails Shroud pins	
Slide No.		Neg No:		Fabric Other finds	
Description					
Discussion					
Shape, dimensions and distinguishing characteristics					
LID					
HEAD					
BASE					
Recorder: DS		Date: 14/9		Initials:	

Coffin Recording Sheet

Site Code

Context

Outer Coffin

Sample Ret.

02R00

243

Recording Date 26/9/00

Associated Numbers

Condition

Dep. Plate

Legible

Inscription

Fabric lead ormolou brass tin plated pewter gilt tin
 iron silvered tin enamelled other Sample Ret.

Shape of dep. plate

square rectangle shield tapered lozenge
 cartouche oval other

Upholstery

colour shoddy velvet other Sample Ret.

Construction

butt joint mitred pitched other

Grip plate Fabric = ormolou brass tin plated pewter gilt tin
 iron silvered tin enamelled other Sample Ret.

Grip Fabric = ormolou brass iron Sample Ret.

Design swag of rose horseshoe cherub's head plain
 other

Grip bolts Corner bolts Type = gilt brass brass iron

other Sample Ret.

Lid motifs other Sample Ret.

Escutcheons other Sample Ret.

Upholstery nails brass gilt brass silvered brass iron x 3, enamelled
 other Total = 21 studs
 1x 0000 | 1x 00000 | 1x 0000

Fixings panel nails screws hinges lace Sample Ret.

Timber type Sample Ret.

Interpretation / Comments

.....

db

SITE	COLR 00	COFFIN RECORD SHEET	CONTEXT NO.
Trench:		Additional sheets: YES x1	Treatment: Bones Collected
Site sub-div:	NC	Grave fills	
Plan no:	3	Grave cut:	Finds None
Section no:	-	Skeleton: 244	Breastplate Grip ✓
Co-ordinates:		Matrix location:	Hinge Bracket
Levels		Preservation:	Fixing nails Shroud pins
Slide No.		Neg No:	Fabric Other finds
<p>Description: Wooden coffin badly decayed. Some truncation of the remains no cranium or mandible. Body E-W, feet to east.</p> <p>Discussion: individual burial, quite high-up, disturbance at feet end by vault 208</p>			
Shape, dimensions and distinguishing characteristics			
LID			
HEAD			
BASE			
Recorder:	BERO	Date:	14-9-00
		Initials:	Biford

Site Code

Context

Outer Coffin

Sample Ret.

01R00

244

Recording Date

Associated Numbers

Condition

Dep. Plate

Legible

Inscription

Fabric lead ormolou brass tin plated pewter gilt tin
 iron silvered tin enamelled other Sample Ret.

Shape of dep. plate

square rectangle shield tapered lozenge
 cartouche oval other

Upholstery

colour shoddy velvet other Sample Ret.

Construction

butt joint mitred pitched other

Grip plate

Fabric = ormolou brass tin plated pewter gilt tin

iron silvered tin enamelled other Sample Ret.

knags on rev. of grip - unid.

Grip

Fabric = ormolou brass iron Sample Ret.

x 1 knag - unid.

Design

swag of rose horseshoe cherub's head plain

other

Grip bolts

Corner bolts Type = gilt brass brass iron

other Sample Ret.

Lid motifs

other Sample Ret.

Escutcheons

other Sample Ret.

Upholstery nails

brass gilt brass silvered brass iron enamelled

other Sample Ret.

Fixings

panel nails screws hinges lace Sample Ret.

Timber type

Sample Ret.

Interpretation / Comments

.....

db.

SITE		COFFIN RECORD SHEET		CONTEXT NO. 245	
Trench:		Additional sheets:	YES x 1	Treatment:	Bones collected Part of coffin wood with brass tacks
Site sub-div:	NC	Grave fills:		Finds:	None
Plan no:	3	Grave cut:		Breastplate:	
Section no:		Skeleton:	245	Grip:	
Co-ordinates:		Matrix location:		Hinge:	
Levels:		Preservation:		Bracket:	
Slide No.:		Neg No.:		Fixing nails:	
				Shroud pins:	
				Fabric:	
				Other finds:	Brass tacks.
<p>Description Wooden coffin, with brass tacks. E-W body feet to East latest in sequence & 3 at higher level (others are 247/248)</p> <p>Discussion coffin & skeleton possibly partly disturbing 247/248</p>					
<p>Shape, dimensions and distinguishing characteristics</p> <p>LID</p> <p>HEAD</p> <p>BASE</p>					
Recorder:	B. Ford	Date:	14.9.00	Initials:	

Site Code

Context

Outer Coffin

Sample Ret.

OLROO

~~245~~
245

Recording Date 13/10

Associated Numbers

Condition

Dep. Plate

Legible

Inscription

Fabric lead ormolou brass tin plated pewter gilt tin
 iron silvered tin enamelled other Sample Ret.

Shape of dep. plate

square rectangle shield tapered lozenge
 cartouche oval other

Upholstery

colour shoddy velvet other Sample Ret.

Construction

butt joint mitred pitched other

Grip plate

Fabric = ormolou brass tin plated pewter gilt tin
frag on rev. of grip
 iron silvered tin enamelled other Sample Ret.

Grip

Fabric = ormolou brass iron ^{x 4} _(3b) Sample Ret.

Design

swag of rose horseshoe cherub's head plain

other

Grip bolts

Corner bolts Type = gilt brass brass iron

other Sample Ret.

Lid motifs

other Sample Ret.

Escutcheons

other Sample Ret.

Upholstery

studs
 nails brass ^{x 1 piece} gilt brass silvered brass iron enamelled

other *1 X* Sample Ret.

Fixings

panel nails screws hinges lace Sample Ret.

Timber type

Sample Ret.

Interpretation / Comments

.....

dhb.

SITE	COFFIN RECORD SHEET		CONTEXT NO.
OLR 00	Additional sheets: YES x 2		246 Treatment: Bones collected
Trench:	Grave fills		
Site sub-div: NC	Grave cut:		Finds None
Plan no: 3	Skeleton: 246		Breastplate Grip
Section no:	Matrix location:		Hinge Bracket
Co-ordinates:	Preservation:		Fixing nails ✓ Shroud pins
Levels	Neg No:		Fabric Other finds
Slide No.			
<p>Description</p> <p>Feet + lower legs? only truncated by later grave cuts</p> <p>Discussion</p>			
<p>Shape, dimensions and distinguishing characteristics</p> <p>LID</p> <p>HEAD</p> <p>BASE</p>			
Recorder: B. Ford	Date: 14.09.00		Initials:

Site Code

Context

Outer Coffin

Sample Ret.

OLROO

246

Recording Date 20/9/00

Associated Numbers

Condition poor

Dep. Plate

Legible

Inscription

Fabric lead ormolou brass tin plated pewter gilt tin
 iron silvered tin enamelled other Sample Ret.

Shape of dep. plate

square rectangle shield tapered lozenge
 cartouche oval other

Upholstery

colour shoddy velvet other Sample Ret.

Construction

butt joint mitred pitched other

Grip plate Fabric = ormolou brass tin plated pewter gilt tin
 iron silvered tin enamelled other Sample Ret.

Grip Fabric = ormolou brass iron Sample Ret.

Design swag of rose horseshoe cherub's head plain

other

Grip bolts Corner bolts Type = gilt brass brass iron

other Sample Ret.

Lid motifs other see following page Sample Ret.

Escutcheons other Sample Ret.

Upholstery nails brass gilt brass silvered brass iron enamelled

other see following page Sample Ret.

Fixings panel nails screws hinges lace Sample Ret.

Timber type Sample Ret.

Interpretation / Comments

.....

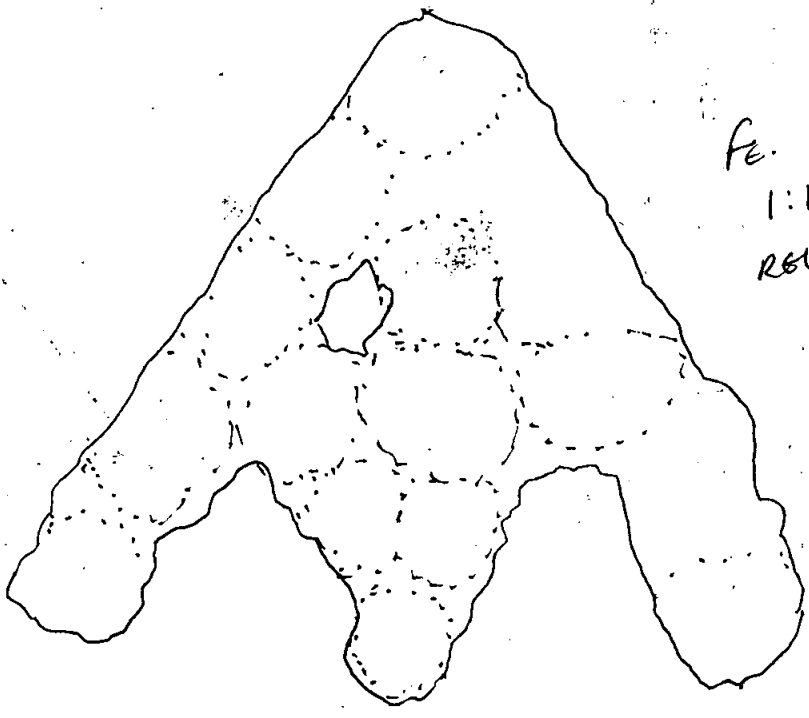

Fe. up stud design connected
~~together~~ together
 1:1 sketch
 Rev. has c. 18
 Fe. pins with ferrous
 wood attached
~~part of design which~~
~~could match sptds 3/~~
~~4/5/7 etc.~~
 part of design which
 could match sptds 3/
 4/5/7 etc.

Ab

SITE OLR 00	COFFIN RECORD SHEET	CONTEXT NO. 247
Trench:	Additional sheets: YES XI.	Treatment: Bones collected along with 248
Site sub-div: NC	Grave fills	Finds None
Plan no: 3	Grave cut:	
Section no:	Skeleton: 247	Breastplate Grip
Co-ordinates:	Matrix location:	Hinge Bracket
Levels	Preservation:	Fixing nails Shroud pins
Slide No.	Neg No:	Fabric Other finds
<p>Description 247 near complete skeleton but lower skeletal remains doubled 248. bagged together. E-W burial feet to east.</p> <p>Discussion 247 was more complete once upper skeleton bagged 248 became apparent from pelvis down. ∴ double set of lower skeletal bones - legs lying v. close to each other pelvis within pelvis. result of collapse of later burial²⁴⁸ onto 247.</p>		
<p>Shape, dimensions and distinguishing characteristics</p> <p>LID</p> <p>HEAD</p> <p>BASE</p>		
Recorder: B. GRD	Date: 14.09.00	Initials:

Coffin Recording Sheet

Site Code

Context

Outer Coffin

Sample Ret.

OL100

247

Recording Date 13/10

Associated Numbers

Condition

Dep. Plate

Legible

Inscription

Fabric lead ormolou brass tin plated pewter gilt tin
 iron silvered tin enamelled other Sample Ret.

Shape of dep. plate

square rectangle shield tapered lozenge
 cartouche oval other

Upholstery

colour shoddy velvet other Sample Ret.

Construction

butt joint mitred pitched other

Grip plate

Fabric = ormolou brass tin plated pewter gilt tin
leags on rev. of grip
 iron silvered tin enamelled other Sample Ret.

Grip

Fabric = ormolou brass iron ^{x 4} (36) Sample Ret.

Design

swag of rose horseshoe cherub's head plain

other

Grip bolts

Corner bolts Type = gilt brass brass iron

other Sample Ret.

Lid motifs

other Sample Ret.

Escutcheons

other Sample Ret.

Upholstery nails

brass gilt brass silvered brass iron enamelled

other Sample Ret.

Fixings

panel nails screws hinges lace Sample Ret.

Timber type

..... Sample Ret.

Interpretation / Comments

.....

db.

SITE		COFFIN RECORD SHEET		CONTEXT NO.	
OLR 00				248	
Trench:		Additional sheets:		Treatment: Bones collected together with 247	
Site sub-div: NC		Grave fills			
Plan no: 3		Grave cut:		Finds	
				None	
Section no:		Skeleton: 248		Breastplate	
				Grip	
Co-ordinates:		Matrix location:		Hinge	
				Bracket	
Levels		Preservation:		Fixing nails	
				Shroud pins	
Slide No.		Neg No:		Fabric	
				Other finds	
				:	
Description lower skeletal remains only to Pelvis to feet. Truncated by unknown agent.					
Discussion					
Shape, dimensions and distinguishing characteristics					
LID					
HEAD					
BASE					
Recorder: B. Ford		Date: 14-09-00		Initials:	

00

SITE OLR 00	COFFIN RECORD SHEET	CONTEXT NO. 249
Trench:	Additional sheets: YES x 1	Treatment: Bones collected
Site sub-div: NC	Grave fills	
Plan no: 3	Grave cut:	Finds None
Section no:	Skeleton: 249 (under 243 but over 250. in sep grave location)	Breastplate Grip
Co-ordinates:	Matrix location: ↓	Hinge
Levels	Preservation:	Bracket Fixing nails Shroud pins
Slide No.	Neg No:	Fabric Other finds
<p>Description Wooden coffin + skeleton. partly collapsing into 250 at head end. 'Partly' truncated, E-W feet at E end.</p> <p>Discussion Individual burial in wooden coffin.</p>		
<p>Shape, dimensions and distinguishing characteristics</p> <p>LID</p> <p>HEAD</p> <p>BASE</p>		
Recorder:	Date:	Initials:

Outer Coffin

Sample Ret.

Site Code

Context

Recording Date 18/10

0200

248

Associated Numbers

Condition

Dep. Plate

Legible

Inscription

Fabric lead ormolou brass tin plated pewter gilt tin
 iron silvered tin enamelled other Sample Ret.

Shape of dep. plate

square rectangle shield tapered lozenge
 cartouche oval other

Upholstery

colour shoddy velvet other Sample Ret.

Construction

butt joint mitred pitched other

Grip plate Fabric = ormolou brass tin plated pewter gilt tin
 iron silvered tin enamelled other Sample Ret.
frag. on rev. of grip.

Grip Fabric = ormolou brass iron ^{x3} Sample Ret.

Design swag of rose horseshoe cherub's head plain
 other *bodily conc. (2b)'s.*

Grip bolts Corner bolts Type = gilt brass brass iron
 other Sample Ret.

Lid motifs other Sample Ret.

Escutcheons other Sample Ret.

Upholstery ^{sheds} ^{nails} brass ^{x 1 pieces} gilt brass silvered brass iron enamelled
 other *3 x sheeps + 1 x ~~8000~~ = stud total 20.*

Fixings panel nails screws hinges lace Sample Ret.

Timber type Sample Ret.

Interpretation / Comments

.....

16

SITE		COFFIN RECORD SHEET		CONTEXT NO.	
OLR 00				250	
Trench:		Additional sheets:		Treatment:	
		YES X1		Bones collected	
Site sub-div:		Grave fills			
NC					
Plan no:		Grave cut:		Finds	
3				None	
Section no:		Skeleton:		Breastplate	
		250 cuts		Grip	
Co-ordinates:		Matrix location:		Hinge	
		under 249.		Bracket	
Levels		Preservation:		Fixing nails	
		Good		Shroud pins	
Slide No.		Neg No:		Fabric	
				Other finds	
Description					
Wooden coffin + skeleton E-W with feet at East. Skeleton near complete some truncation on south side (ie the right side).					
Discussion					
Shape, dimensions and distinguishing characteristics					
LID					
HEAD					
BASE					
Recorder:		Date:		Initials:	
B. Ford		14-09-00			

Site Code

Context

ORL00

250

Outer Coffin

Sample Ret.

Recording Date

Associated Numbers

Condition

Dep. Plate

Legible

Inscription

Fabric lead ormolou brass tin plated pewter gilt tin
 iron silvered tin enamelled other Sample Ret.

Shape of dep. plate

square rectangle shield tapered lozenge
 cartouche oval other

Upholstery

colour shoddy velvet other Sample Ret.

Construction

butt joint mitred pitched other

Grip plate Fabric = ormolou brass tin plated pewter gilt tin
 iron silvered tin enamelled other Sample Ret.

Grip Fabric = ormolou brass iron Sample Ret.

Design swag of rose horseshoe cherub's head plain
 other

Grip bolts **Corner bolts** **Type =** gilt brass brass iron
 other Sample Ret.

Lid motifs other Sample Ret.

Escutcheons other Sample Ret.

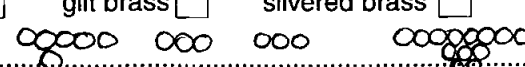
Upholstery ^{studs} ~~nails~~ brass gilt brass silvered brass iron ^{x4} ~~peaks~~ enamelled
 other *Total of 25 studs:*  Sample Ret.

Fixings panel nails screws hinges lace Sample Ret.

Timber type Sample Ret.

Interpretation / Comments

.....

SITE OLROO		CONTEXT RECORD		Context No. 251
Trench		Additional Sheets: YES 1		Type STRUCTURE
Site sub-div. CRYPT		Context Type: Deposit / Cut / (Structure)		Check Lists:
Structure No.		Overlain by:		DEPOSIT: 1.compaction 2.colour 3.composition 4.inclusions 5.thickness 6.extent 7.comments 8.method & conditions
Plan No. 5/7		Abutted by:		
Section No.		Cut by:		CUT: 1.shape in plan 2.base/sides/top profile 3.dimension and depth 4.sketch 5.truncation 6.fill nos 7.other comments
Co-Ordinates		Fill of: Contains burials 253-255, 493-495		
Level		Same as:		MASONRY: 1.materials 2.size of bricks etc 3.finish of stones 4.coursing/bond 5.form 6.faces 7.bond 8.dimensions as found 9.other comments
Slide No.		Part of:		
Neg No.		Consists of:		
Matrix location		Overlies:		
		Butts:		
		Cuts:		
		Fill of:		
		Relationships uncertain		

Description (See check lists):

Brick vault measuring: - 2.40 x 1.40m (internal)

Bricks: - 0.22 x 0.105 x 0.065m

Mortar: - Hard, grey with lime? inclusions.

Arched entrance (blocked with brick) in W facing wall.

Small stone plaque in north wall: - Inscription → W. WOOD Gent. 1756
contained 6 burials in lead coffins

Walls 0.33m thick - west wall incl a single 'skin' which sealed entrance.

'Raised' floor (above main floor of Bay 1) of brick.

Interpretation/Discussion:

Brick vault in SE corner of Bay 1 of crypt.

- Walls tied in to main crypt structure - prob constructed at same time as main crypt - uses other walls of crypt / roof to form vault.

- vault wall had into 'blocking' to 'arch' in line with passageway across this crypt bays - this prob similar to corresponding feature in N wall of church i.e. an arch intended to be knocked out to an outer vault/crypt but never actually completed.

Finds (tick): None Pot Bone Flint Stone Burnt stone Glass Metal
CBM Wood Leather

△ Small Finds

Recorder DS

◇ Samples

Date 15/9

△ Building Materials

Initials

STRATIGRAPHIC MATRIX

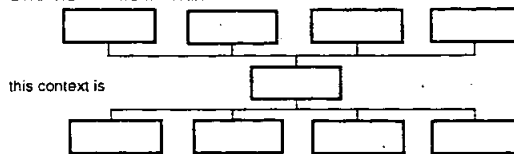

SITE
OLR00

CONTEXT RECORD ADDITIONAL SHEET

Context No.
251

BURIALS

In Vault 251: 6 lead coffin burials:-
253 → 255, 493 → 495

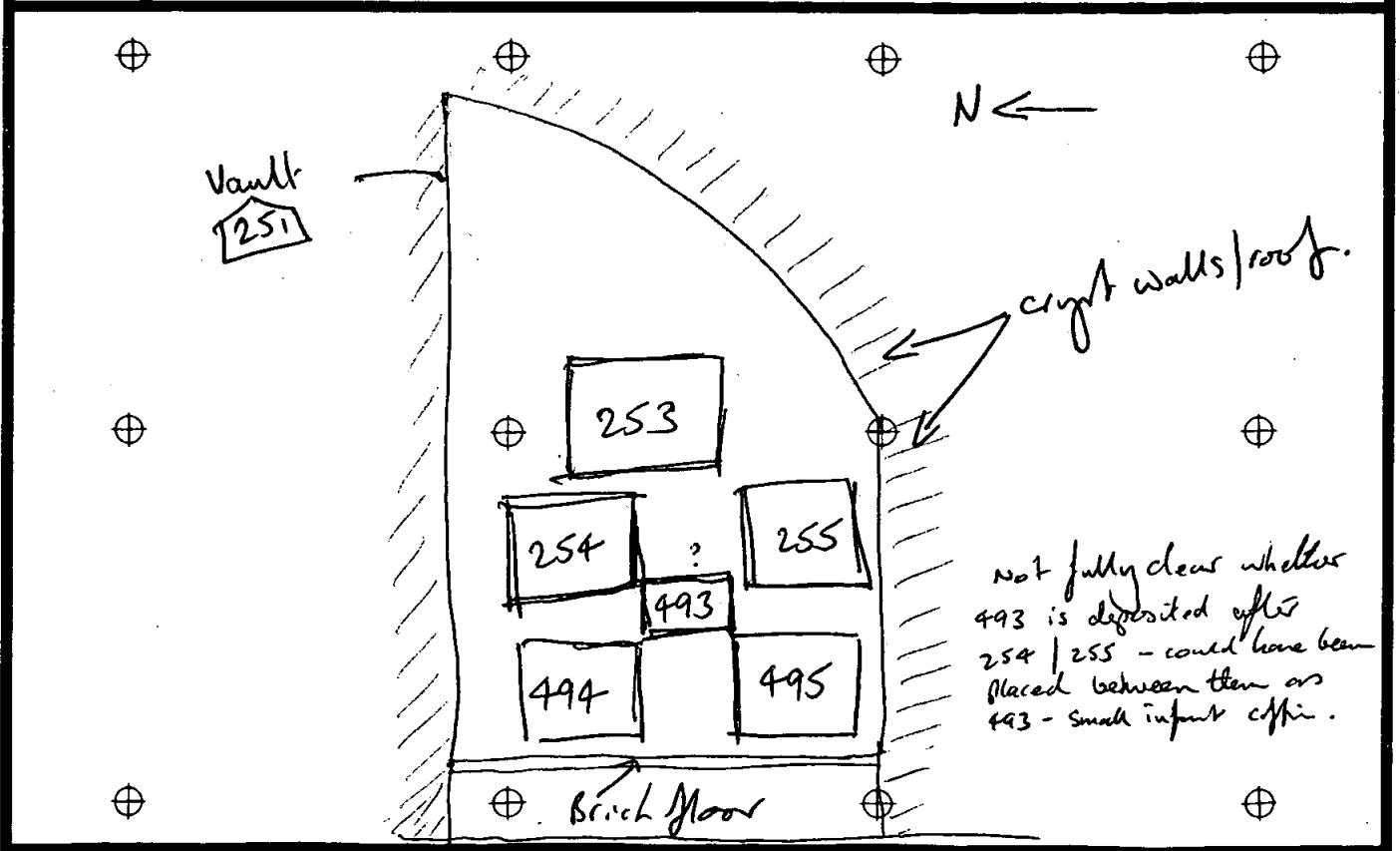

db

SITE <i>OLR00</i>		COFFIN RECORD SHEET	CONTEXT NO. <i>252</i>
Trench:	Additional sheets: <i>YES x 2</i>	Treatment: <i>Bones collected</i>	
Site sub-div: <i>NC</i>	Grave fills		
Plan no: <i>3</i>	Grave cut:	Finds None	
Section no:	Skeleton:	Breastplate Grip <input checked="" type="checkbox"/>	
Co-ordinates:	Matrix location:	Hinge Bracket <i>up. studs</i> Fixing nails <input checked="" type="checkbox"/>	
Levels	Preservation:	Shroud pins	
Slide No.	Neg No:	Fabric Other finds	
Description <i>Burial.</i>			
Discussion			
Shape, dimensions and distinguishing characteristics			
LID			
HEAD			
BASE			
Recorder:	Date:	Initials:	

Outer Coffin

Sample Ret.

Site Code

Context

Recording Date 21/9/00

orkoo

252

Associated Numbers

Condition 1

Dep. Plate

Legible

Inscription

Fabric lead ormolou brass tin plated pewter gilt tin
 iron silvered tin enamelled other Sample Ret.

Shape of dep. plate

square rectangle shield tapered lozenge
 cartouche oval other

Upholstery

colour shoddy velvet other Sample Ret.

Construction

butt joint mitred pitched other

Grip plate Fabric = ormolou brass tin plated pewter gilt tin

iron silvered tin enamelled other Sample Ret.
flag on rev. of grip - poss. part of spiffels 13?

Grip Fabric = ormolou brass iron *x 1* Sample Ret.

Design

swag of rose horseshoe cherub's head plain

other prob. spiffels 20.

Grip bolts **Corner bolts** **Type =** gilt brass brass iron

other Sample Ret.

Lid motifs other Sample Ret.

Escutcheons other Sample Ret.

Upholstery ^{studs} ~~nails~~ *x 8* brass gilt brass silvered brass iron enamelled

other Sample Ret.

Fixings panel nails screws hinges lace Sample Ret.

Timber type Sample Ret.

Interpretation / Comments

.....

OLR00

fe. up. studs.

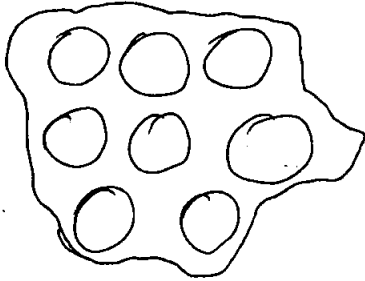

SITE: <u>OLR90</u>		COFFIN RECORD SHEET	CONTEXT NO. <u>253</u>
Trench: <u>251 vault</u>	Additional sheets: <u>Yes x 2(3)</u>	Treatment: <u>INTACT.</u> <u>NO SAMPLES TAKEN</u>	
Site sub-div: <u>CRYPT.</u>	Grave fills	Finds	
Plan no: <u>7</u>	Grave cut:	None	
Section no:	Skeleton:	Breastplate	
		Grip	
Co-ordinates:	Matrix location: <u>253 over 254 (in vault 251)</u>	Hinge	
		Bracket	
Levels	Preservation: <u>good.</u>	Fixing nails	
		Shroud pins	
Slide No.	Neg No:	Fabric	
		Other finds	

Description
 triple w/ up. stud dec on lid/ head dep. plates + fe lid motif. pb shell diag. scored/ no grips intact, some dec fallen on to 254 beneath/ fe up studs in double row - lid only

Discussion
 intact - 2 x grips & plates resting on lid of 254 prob. from 253 - samples taken. pb reinforcing strip on LHS shoulder soldered flush.

Shape, dimensions and distinguishing characteristics

LID

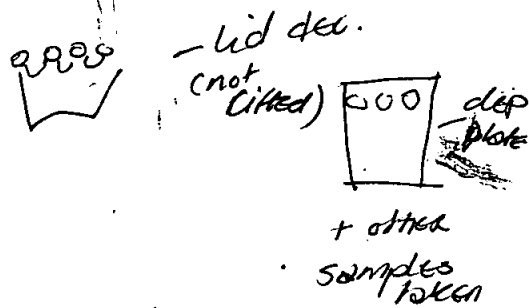
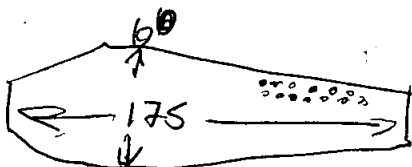

HEAD

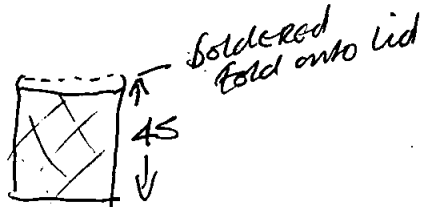

BASE

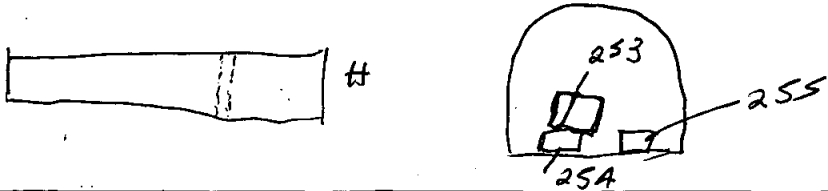

Recorder: _____ Date: _____ Initials: _____

db.

SITE OLR00	COFFIN RECORD SHEET	CONTEXT NO. 254 254
Trench: crypt.	Additional sheets: YES x 2	Treatment: SKULL LIFTED & DNA TAKEN.
Site sub-div:	Grave fills	
Plan no: 7	Grave cut:	Finds None
Section no:	Skeleton:	dep plate (Anatomical) Breastplate Grip + plate - hanger to plate
Co-ordinates:	Matrix location: under 253 251 (in vault) 251 251	Hinge Bracket upstuds - fe
Levels	Preservation: 2 2 (body 1)	Shroud pins
Slide No.	Neg No:	Fabric Other finds

Description
keiple shell
1 x head fe grip & plate - no match
~~handgrip plate~~
6 x escutcheons observed (3 lifted)

Discussion
p.b. mandible
Bonnet
frill
up-studs
body beamed w/ coarse weave textile lining on inner surface of wood case & linen? bonnet frags - perf. euffle meeting under chin. 7 x keft cuts.

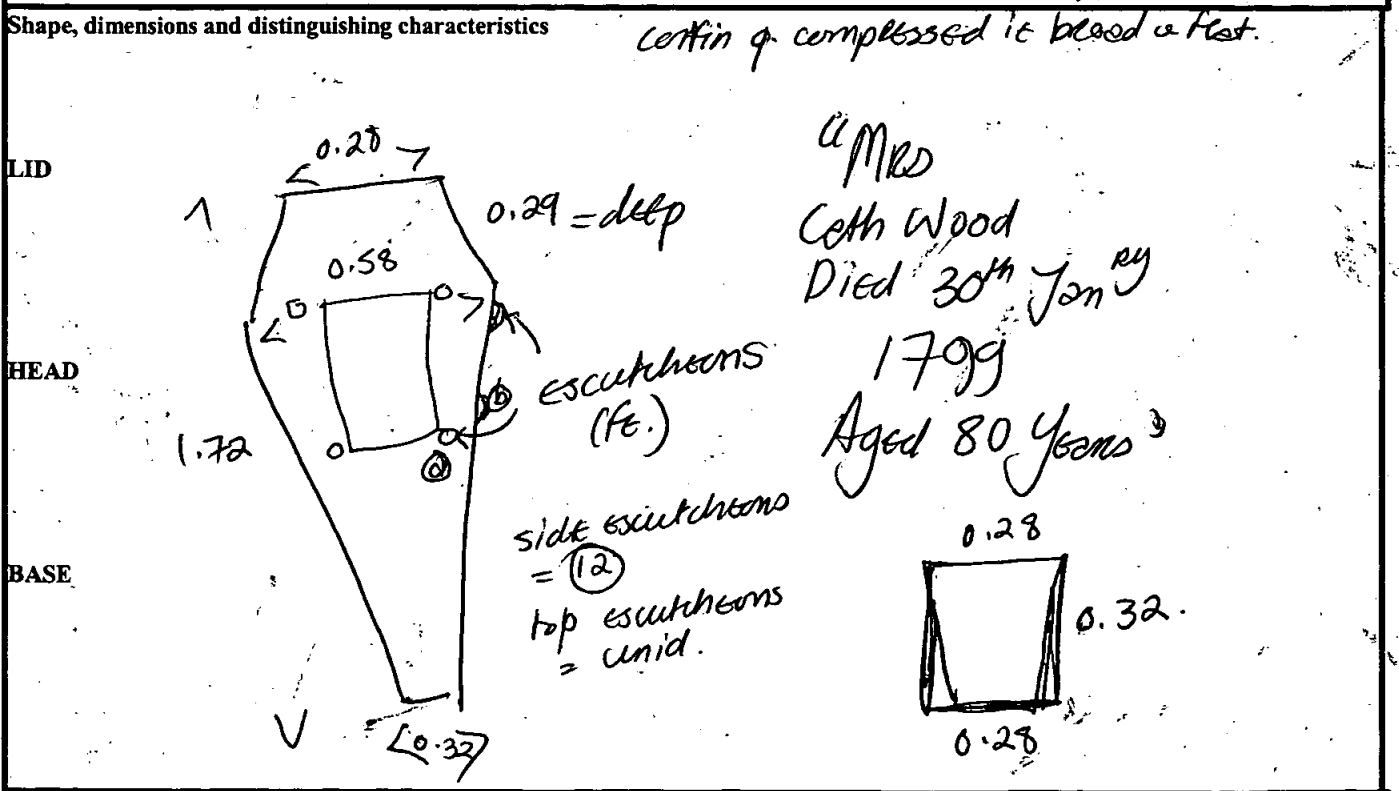

Recorder: _____ Date: 4/15 Initials: MR

Site Code

Context

ORLOO

254

Outer Coffin

Sample Ret.

Recording Date 4/10

Associated Numbers 253

Condition 3

Dep. Plate

Legible

Inscription

Fabric lead

ormolou

brass

tin plated pewter

gilt tin

iron

silvered tin

enamelled

other

Sample Ret.

black polished

Shape of dep. plate

square

rectangle

shield

tapered

lozenge

cartouche

oval

other

= 5 pths (9) w/out outer border

Upholstery

colour

shoddy

velvet

other *BAIZE*

Sample Ret.

Construction

butt joint

mitred

pitched

other

Grip plate

Fabric = ormolou

brass

tin plated pewter

gilt tin

iron

silvered tin

enamelled

other

Sample Ret.

Grip

Fabric = ormolou

brass

iron

Sample Ret.

Design

swag of rose

horseshoe

cherub's head

plain

other

Grip bolts

Corner bolts

Type = gilt brass

brass

iron

other Sample Ret.

Lid motifs

other Sample Ret.

Escutcheons

other *fe. x 6 seen - 3 lifted (2 of which are) (12) & 1 unid* Sample Ret.

Upholstery nails

brass

gilt brass

silvered brass

iron

enamelled

other *800* Sample Ret.

Fixings

panel nails

screws

hinges

lace

Sample Ret.

Timber type

Sample Ret.

Interpretation / Comments

.....

db

SITE	COFFIN RECORD SHEET	CONTEXT NO.
OL 200		254
Trench: CRYPT	Additional sheets: YES x 3	Treatment: SKEL Y LIFTED u DNA TAKEN BONES ROOR
Site sub-div:	Grave fills	(inc. vertebrae)
Plan no: 7	Grave cut:	Finds None dep plate (B) still in situ ? redeposited?
Section no:	Skeleton:	Grip x 5
Co-ordinates:	Matrix location: (RHS) adjacent to 254 (in vault 251)	Hinge
Levels	Preservation: 3 (BODY 1)	Bracket up studs Firing nails
Slide No.	Neg No:	Shroud pins Fabric Other finds

Description
triple shell w/ intact ^{pb} dep plate (base) + 5 x grips (1 @ head -) wood 1" thick, scored pb for wood steel, + lid motif. 5x kerf cuts. Coarse lining material

Discussion
w/ finer (linen?) ruffle running length of inner lid edge.

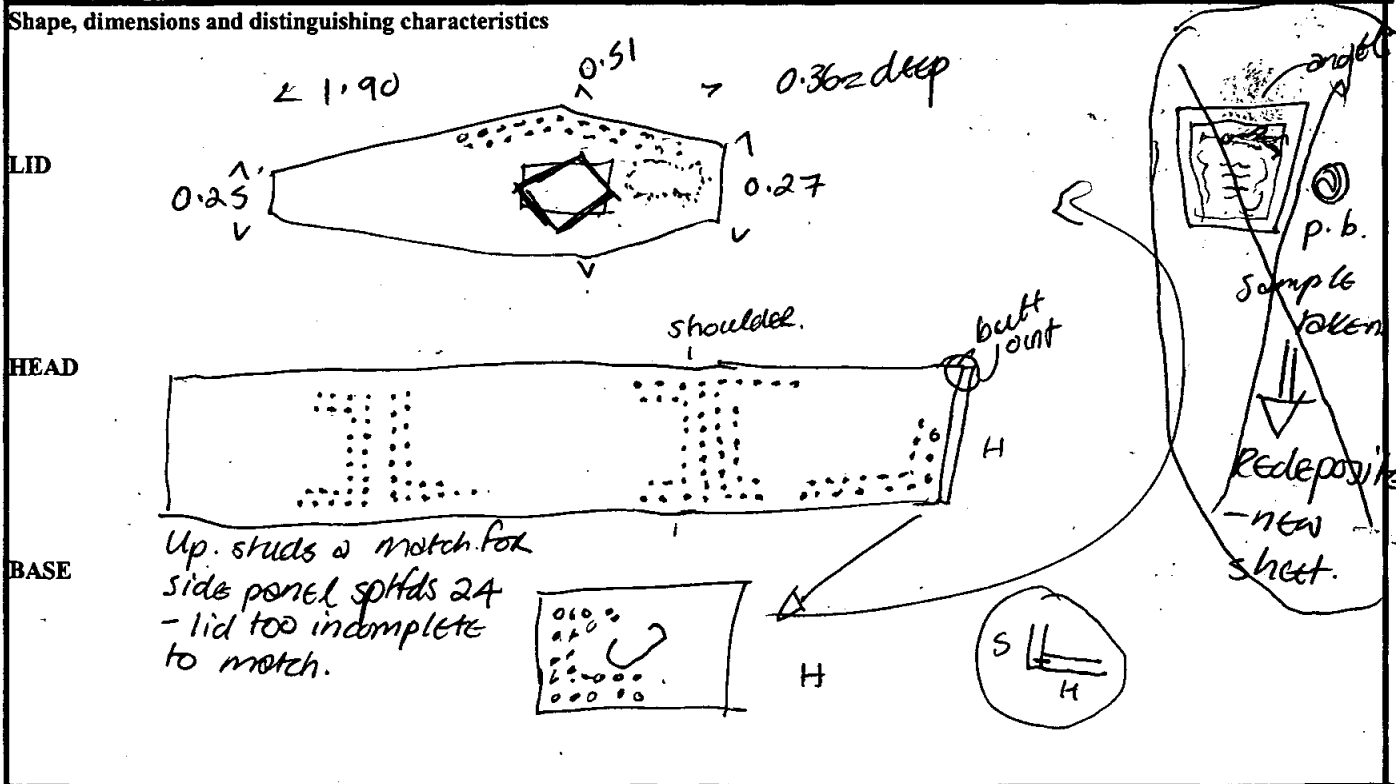

Recorder: _____ Date: A/10 Initials: MR

Site Code

Context

Outer Coffin

Sample Ret.

ORL00

255

Recording Date 1980/9/100

Associated Numbers in vault

Condition fair

Dep. Plate

Legible

Inscription

(see following page - no marks in Spt Hds compas - redeposited. - new number.)

Fabric lead ~~iron~~ ormolou brass tin plated pewter gilt tin
iron silvered tin enamelled other Sample Ret.

Shape of dep. plate

square rectangle shield tapered lozenge
cartouche oval other

Upholstery

colour shoddy velvet other Sample Ret.

Construction

butt joint *outer wooden case.* mitred pitched other

Grip plate Fabric = ormolou brass tin plated pewter gilt tin
iron silvered tin enamelled other Sample Ret.

Grip Fabric = ormolou brass iron *S Spt Hds 5.* Sample Ret.

Design

swag of rose horseshoe cherub's head plain

other

Grip bolts Corner bolts Type = gilt brass brass iron

other Sample Ret.

Lid motifs other *'flaming urn' Spt Hds 2* Sample Ret.

Escutcheons other Sample Ret.

Upholstery nails brass *double row* gilt brass silvered brass iron enamelled

other Sample Ret.

Fixings panel nails screws hinges lace Sample Ret.

Timber type Sample Ret.

Interpretation / Comments

.....
.....

~~dep~~ 'Flaming urn' - c. 32 x 20 cm (⊙ widest point)

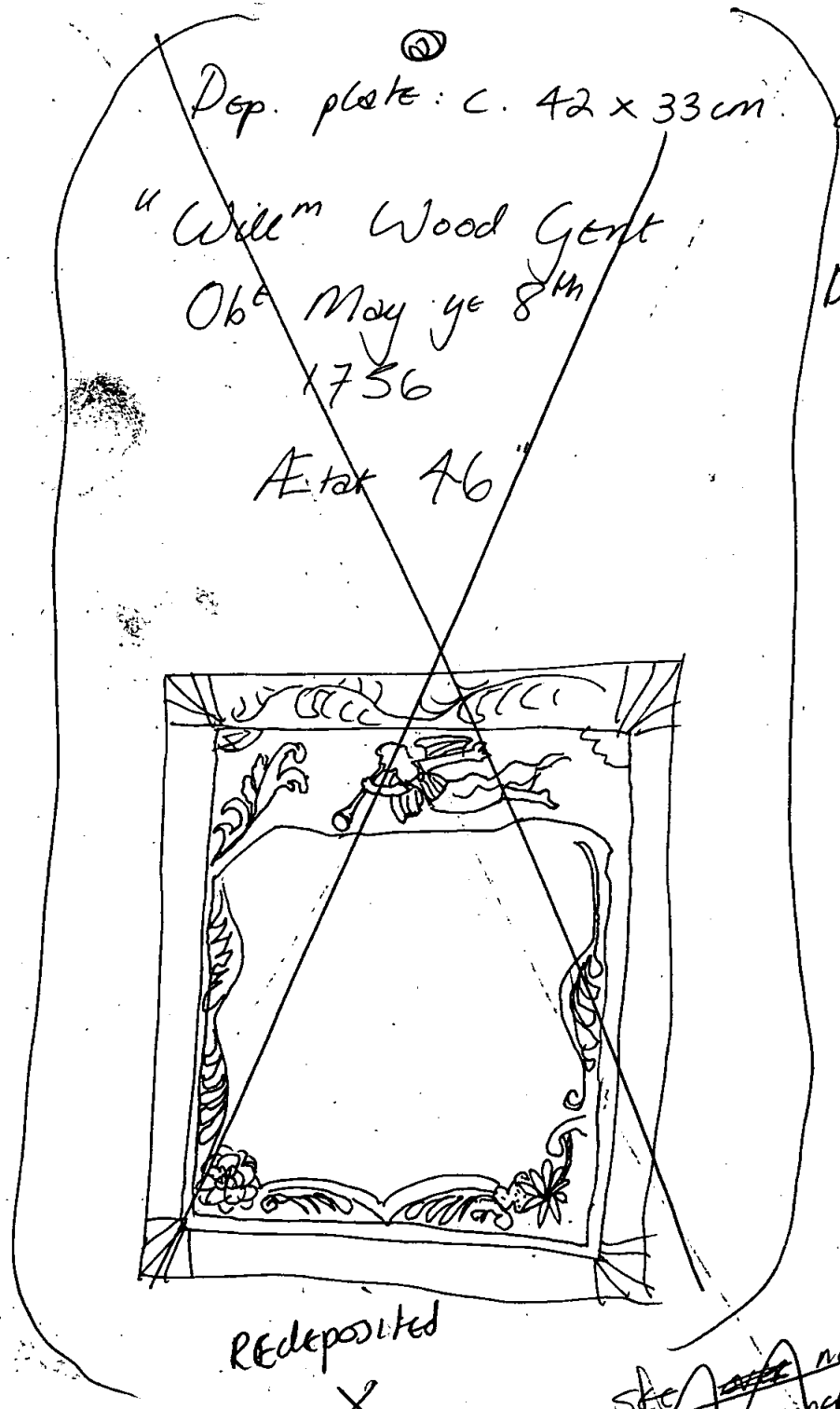

⊙ pinned to
p.b. lid.
"Miss
Cath Forbes
Died 11th May
1796
In her 17th year
of her Age"

Redeposited
X

see ~~next page~~
for ~~proper~~ sketch.

db

301-304-V12
305-308-V15

SITE	COFFIN RECORD SHEET	CONTEXT NO.
OLR00		256
Trench: CRYPT	Additional sheets:	Treatment: SKELETON LIFTED
Site sub-div:	Grave fills	
Plan no: 7	Grave cut:	Finds None <input checked="" type="checkbox"/> dep. inscription dep. brass
Section no:	Skeleton:	Bronzplate <input checked="" type="checkbox"/> Grip
Co-ordinates:	Matrix location: in box 182 Box 3 OVER 336 (W)	Hinge Bracket
Levels	Preservation:	Fixing nails Shroud pins
Slide No.	Neg No:	Fabric Other finds

Description: infant p.p coffin

Discussion: " Miss Stevens
Ester Stephens
Died 7th February
1839
Aged 5 Month
& 2 Weeks"

PRE-modern redeposited
- remains @
one end of
COFFIN
- upside down.

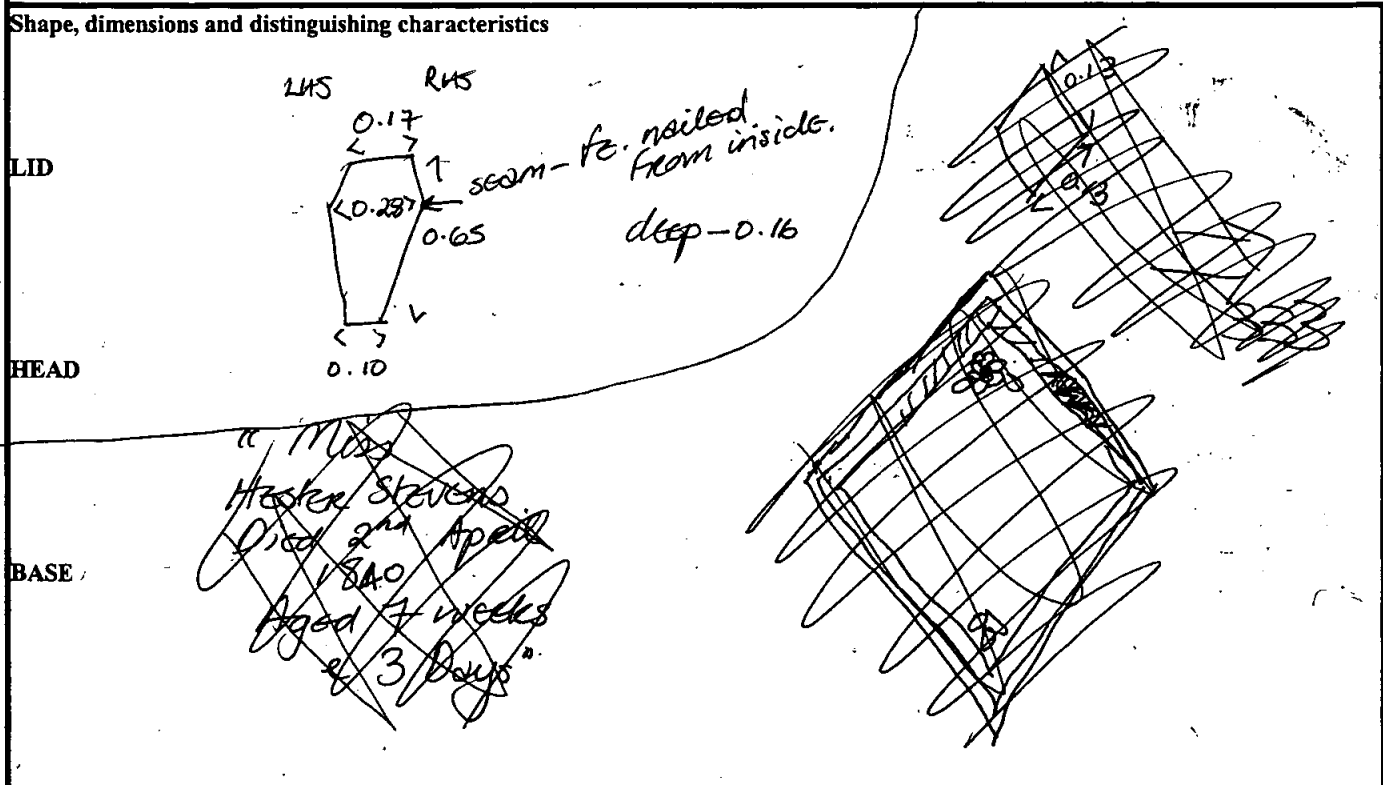

Recorder: _____ Date: _____ Initials: _____

db

SITE OLR00	COFFIN RECORD SHEET	CONTEXT NO. By 257
Trench:	Additional sheets:	Treatment: SKELELY LIFTED
Site sub-div:	Grave fills	
Plan no:	Grave cut:	Finds None
Section no:	Skeleton:	Breastplate Grip
Co-ordinates:	Matrix location: in box 12 OVER 336 Box 3 (W)	Hinge Bracket
Levels	Preservation:	Fixing nails Shroud pins
Slide No.	Neg No:	Fabric Other finds
Description infant p.b. coffin		Pre-modern Redeeposited-remains @ one end of coffin
Discussion		
Shape, dimensions and distinguishing characteristics		
LID		no dep. plots but fe nail marks suggest <input type="checkbox"/>
HEAD		
BASE		
Recorder:	Date:	Initials:

depth = 0.20

dh

SITE OLR00	COFFIN RECORD SHEET	CONTEXT NO. 258
Trench: CRMP7	Additional sheets:	Treatment: SKELLY LIFTED.
Site sub-div:	Grave fills	ALL BONES & COFFIN LID FOR DNA TAKEN FROM GRAVE - MT.
Plan no: 7	Grave cut:	Finds None
Section no:	Skeleton:	Breastplate <input checked="" type="checkbox"/> <input type="checkbox"/> p.b. Grip
Co-ordinates:	Matrix location: in box 12 over 330. Bay 3 (W)	Hinge Bracket
Levels	Preservation:	Fixing nails Shroud pins
Slide No.	Neg No:	Fabric Other finds

Description: infant p.b. coffin - Pre-modern. Redeposited - remains

Discussion:

Shape, dimensions and distinguishing characteristics

LID

HEAD

BASE

depth = 0.25.

Coffin surface lid diagonally scored under dep. plate.

"Master
Nicholas Stevens
Died 9th August
1836
Aged 3 Years
11 Months & 13 Days"

Recorder:	Date:	Initials:
-----------	-------	-----------

db

SITE OLR00	COFFIN RECORD SHEET	CONTEXT NO. 259
Trench: CRYPT	Additional sheets:	Treatment: INTACT. NO SAMPLES TAKEN.
Site sub-div:	Grave fills	
Plan no: 7	Grave cut:	Finds None
Section no:	Skeleton:	Breastplate <input checked="" type="checkbox"/> <input type="checkbox"/> dir. inscription Grip
Co-ordinates:	Matrix location: Box 3 (W) in vault, over 336 OVER 336	Hinge Bracket
Levels	Preservation:	Fixing nails Shroud pins
Slide No.	Neg No:	Fabric Other finds

Description: infant p.b. coffin

Discussion:

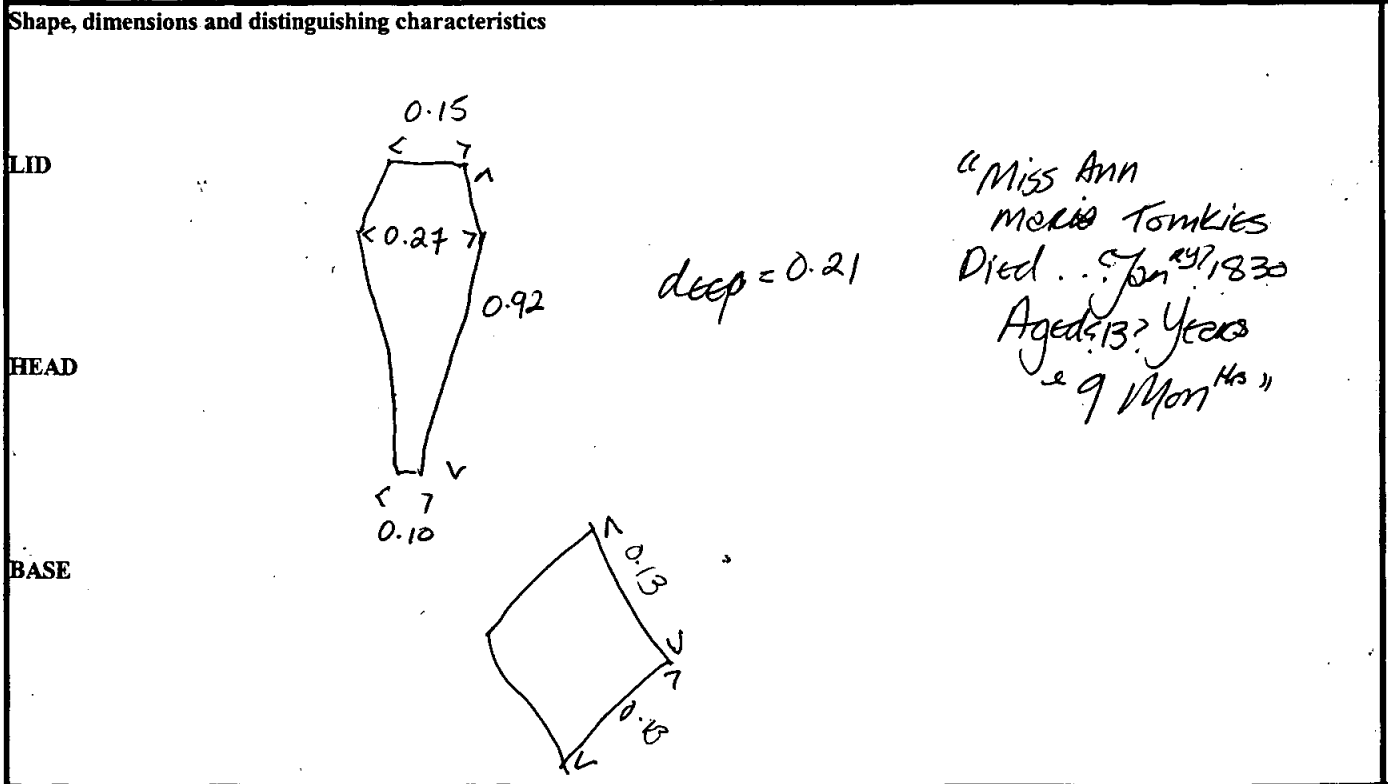

Recorder:	Date:	Initials:
-----------	-------	-----------

Coffin Recording Sheet

Site Code

Context

OH100

260

Outer Coffin

Sample Ret.

Recording Date 18/10

Associated Numbers

Condition

Dep. Plate

Legible

Inscription

Fabric lead ormolou brass tin plated pewter gilt tin
 iron silvered tin enamelled other Sample Ret.

Shape of dep. plate

square rectangle shield tapered lozenge
 cartouche oval other

Upholstery

colour shoddy velvet other Sample Ret.

Construction

butt joint mitred pitched other

Grip plate Fabric = ormolou brass tin plated pewter gilt tin
 iron silvered tin enamelled other Sample Ret.

Grip Fabric = ormolou brass iron ^{x2} 3 @ Sample Ret.

Design swag of rose horseshoe cherub's head plain
 other

Grip bolts Corner bolts Type = gilt brass brass iron

other Sample Ret.

Lid motifs other Sample Ret.

Escutcheons other Sample Ret.

Upholstery ^{shds} ~~nails~~ brass gilt brass silvered brass iron ^{x 6 pieces} enamelled

other ^{4 x strips + 1 x / 1 x} Sample Ret.

Fixings panel nails screws hinges lace Sample Ret.

Timber type Sample Ret.

Interpretation / Comments

.....

db

SITE		COFFIN RECORD SHEET		CONTEXT NO.	
OLR00				261	
Trench:	NC	Additional sheets:	NO NO.	Treatment:	
Site sub-div:		Grave fills			
Plan no:	3	Grave cut:		Finds	
Section no:		Skeleton:		None	
Co-ordinates:		Matrix location:		Breastplate	
Levels		Preservation:		Grip x 1	
Slide No.		Neg No:		Hinge	
Description		grip v. poor - concreted & returns missing.		Bracket	
Discussion		Decorative peice = fragmented & concreted Fe (poss tin-dipped) too poor to identify.		Fixing nails	
Shape, dimensions and distinguishing characteristics				Shroud pins	
LID				Fabric	
HEAD				Other finds 6x Fe nails 1x dec.	
BASE					
Recorder:	Date:	Initials:			

db

SITE O.L.R.O.O.	COFFIN RECORD SHEET	CONTEXT NO. 262
Trench: CRYPT;	Additional sheets: YES x 2	Treatment: bones collected & DNA samples taken
Site sub-div:	Grave fills	
Plan no: 7	Grave cut:	Finds None
Section no:	Skeleton:	Breastplate Grip
Co-ordinates:	Matrix location: adj. to 263 Bay 3	Hinge Bracket
Levels	Preservation: fair	Fixing nails Shroud pins
Slide No.	Neg No:	Fabric Other finds

Description

Discussion

Shape, dimensions and distinguishing characteristics

LID

HEAD

BASE

N (Crypt End)

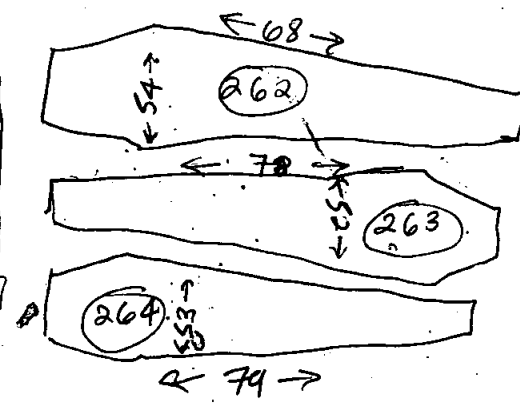

262
pb coffin
non-metallic
brass deep plate (b)
on outside wood casing
+ pb. deep plate (a)
soldered onto lid
- removed

262
264
c. 40 cm deep

Recorder:	Date:	Initials:
-----------	-------	-----------

Coffin Recording Sheet

Site Code

Context

Outer Coffin

Sample Ret.

OL200

262

Recording Date 19/9

Associated Numbers adj. to 263

Condition fair

Dep. Plate 1 of 2

Legible

Inscription

Fabric lead ~~x2~~ 1 ormolou brass x1 tin plated pewter gilt tin
 iron silvered tin enamelled other Sample Ret.

Shape of dep. plate

square rectangle shield tapered x2 lozenge
 cartouche oval other *i.e. both lid plates.*

Upholstery

colour? shoddy velvet other BALZE Sample Ret.

Construction

butt joint mitred pitched other

Grip plate Fabric = ormolou brass tin plated pewter gilt tin
 iron silvered tin enamelled other Sample Ret.

Grip Fabric = ormolou brass iron Sample Ret.

Design swag of rose horseshoe cherub's head plain
 other

Grip bolts Corner bolts Type = gilt brass brass iron
 other Sample Ret.

Lid motifs other Sample Ret.

Escutcheons other Sample Ret.

Upholstery nails brass gilt brass silvered brass iron enamelled
 other Sample Ret.

Fixings panel nails screws hinges lace Sample Ret.

Timber type Sample Ret.

Interpretation / Comments

.....

p6. plate a - similar to sptfds 20 except
border - detail 

" Mrs
Sarah Hathorn
Died 6th Dec^r:

1843
Aged 84 years "

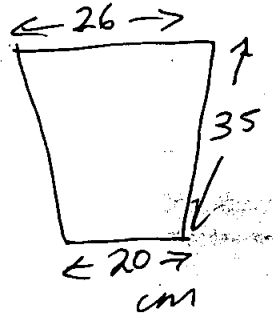

brass plate b - bordered w/ beize; sptfds 20.

" Mrs
SARAH HATHORN
Died 6th DECEMBER
1843
Aged 84 years "

lettering is block etched.

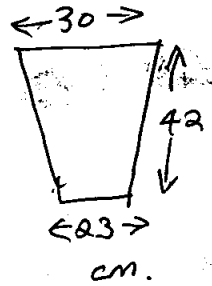

db

SITE	COFFIN RECORD SHEET	CONTEXT NO.
OLR00		263
Trench: CRYPT	Additional sheets: YES x 2	Treatment: sealed - not opened
Site sub-div:	Grave fills	
Plan no: 7	Grave cut:	Finds None
Section no:	Skeleton:	Breastplate Grip
Co-ordinates:	Matrix location: Bay 3 adj. to 262 & 264	Hinge Bracket
Levels	Preservation: intact	Fixing nails Shroud pins
Slide No.	Neg No:	Fabric Other finds

Description SEE 262 sheet.

Discussion

Shape, dimensions and distinguishing characteristics For dimensions
SEE SHEET 262

LID

HEAD

BASE

dep plate a. brass
w/ bronze on Rev.
(orig. from wooden outer case)

dep plate b. pb.
under plate a
orig. on pb coffin

dep plate c. pb.
(under coffin - face down)

Recorder: _____ Date: _____ Initials: _____

Coffin Recording Sheet

Site Code

Context

Outer Coffin

Sample Ret.

OH100

263

Recording Date 19/9

Associated Numbers adj. to 262 & 264

Condition INTACT

Dep. Plate x 3

Legible

Inscription see following sheets

Fabric lead 2 ormolou brass 1 tin plated pewter gilt tin
 iron silvered tin enamelled other Sample Ret.

Shape of dep. plate ^{ix pb} square 2 ^{ix brass} rectangle shield tapered 1 pb. lozenge
 cartouche oval other

Upholstery
 colour shoddy velvet other ~~BATZ~~ Sample Ret.

Construction butt joint mitred pitched other

Grip plate Fabric = ormolou brass tin plated pewter gilt tin
 iron silvered tin enamelled other Sample Ret.

Grip Fabric = ormolou brass iron Sample Ret.

Design swag of rose horseshoe cherub's head plain
 other

Grip bolts Corner bolts Type = gilt brass brass iron
 other

Lid motifs other

Escutcheons other

Upholstery nails brass gilt brass silvered brass iron enamelled
 other

Fixings panel nails screws hinges lace Sample Ret.

Timber type Sample Ret.

Interpretation / Comments

.....

Dep. plate c.

p. b

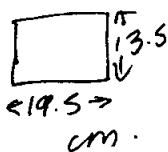

"Henry Cheape
Esq^r"

Died 15th March 1840
Aged 50 years"

Brass

Dep. plate d.

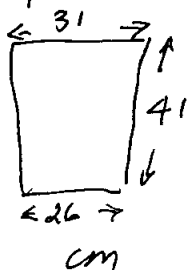

packed w/ brize.

" HENRY CHEAPE
ESQR.

Died 15th March,
1840

AGED 50 YEARS"
black etched.

Dep plate b.

p. b

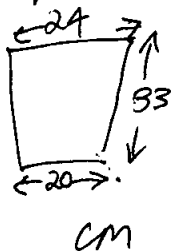

" Henry Cheape
Esq^r"

Died 15th March
1840

Aged 50 Yr^s"

dlb

SITE	COFFIN RECORD SHEET	CONTEXT NO.
OLROO		264
Trench: CRYPT	Additional sheets:	Treatment: skelly collected & DNA samples taken.
Site sub-div:	Grave fills	
Plan no: 7	Grave cut:	Finds None
Section no:	Skeleton: sampled.	Breastplate Grip
Co-ordinates:	Matrix location: Bay 3 adj. to 263	Hinge Bracket
Levels	Preservation: Keil	Fixing nails Shroud pins
Slide No.	Neg No:	Fabric Other finds
Description		see 262 sheet.
Discussion		
Shape, dimensions and distinguishing characteristics		
LID	<p>(plate b "sept. 184 Aged...")</p> <p>dep plate (p.b.) with p.b. (b) beneath soldered onto lid - unremovable.</p>  <p>pb coffin</p>	
HEAD	<p>w/ 2 x frags Fe. brass up. studs - dbl row in wood w/ bronze backing.</p>	
BASE	<p>after opening pb. lid inner wooden case lid was intact - plain.</p> <p>dep plate a dep plate b dep. plate c.</p> <p>brass p.b. (p.b. (under coffin - face down))</p>	
Recorder:	Date:	Initials:

Outer Coffin

Sample Ret.

Site Code

Context

Recording Date 20/9/

OLR00

264

Associated Numbers adj. to 263

Condition GOOD

Dep. Plate X3

Legible

Inscription

see following sheet.

Fabric lead X7 ormolou brass X1 tin plated pewter gilt tin
 iron silvered tin enamelled other Sample Ret.

Shape of dep. plate

square pb. xl rectangle shield tapered brass lozenge
 cartouche oval other back of brass
+ xl p.b.

Upholstery

colour shoddy velvet other BAIZE Sample Ret.

Construction butt joint mitred pitched other

Grip plate Fabric = ormolou brass tin plated pewter gilt tin
 iron silvered tin enamelled other Sample Ret.

Grip Fabric = ormolou brass iron Sample Ret.

Design swag of rose horseshoe cherub's head plain
 other

Grip bolts **Corner bolts** Type = gilt brass brass iron
 other Sample Ret.

Lid motifs other Sample Ret.

Escutcheons other Sample Ret.

Upholstery nails brass gilt brass silvered brass iron enamelled
 other Sample Ret.

Fixings panel nails screws hinges lace Sample Ret.

Timber type Sample Ret.

Interpretation / Comments

.....

dep. plate (c) - p.b.

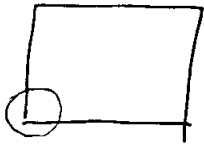

- no sptfals match.
detail.

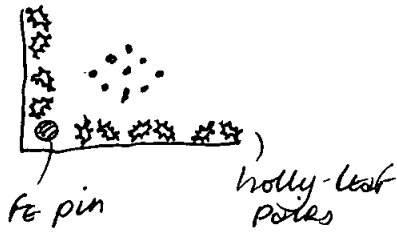

" Geo^g Hathorn
Esq^{re}
1848

dep. plate (d) - brass.
sptfals 20.

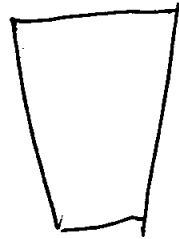

" George Hathorn
Esq^{re}
DIED 13th SEPT^r
1848
Aged 84 years"

Legend is raised etching

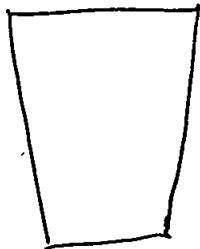

dep plate (b) p.b.
- too oxidised
- illegible

db

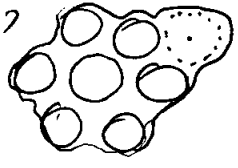
SITE	COFFIN RECORD SHEET	CONTEXT NO.
OLR00 Trench: NC	Additional sheets:	265 Treatment:
Site sub-div:	Grave fills	
Plan no:	Grave cut:	Finds None
Section no:	Skeleton:	Breastplate Grip x 3
Co-ordinates:	Matrix location:	Hinge Bracket up studs.
Levels	Preservation:	Fixing nails ✓ (x 8) Shroud pins
Slide No.	Neg No:	Fabric Other finds
<p>Description 3x grips - frag. & conc, one of which has traces of grip-plate on rev - poss Fe / tin dipped? too frag. to identify. fe. up. studs see sketch below</p> <p>Discussion poss. version of Spflds escutcheon 16?</p> 		
<p>Shape, dimensions and distinguishing characteristics</p> <p>LID</p> <p>HEAD</p> <p>BASE</p>		
Recorder:	Date:	Initials:

SITE		COFFIN RECORD SHEET		CONTEXT NO.	
OLR 00				265	
Trench:		Additional sheets:		Treatment: Bones collected.	
Site sub-div: NC		Grave fills /			
Plan no: 3		Grave cut: /		Finds None	
Section no: /		Skeleton: 265		Breastplate Grip	
Co-ordinates:		Matrix location: o/lies 267		Hinge Bracket	
Levels		Preservation: Fair		Fixing nails Shroud pins	
Slide No.		Neg No:		Fabric Other finds	
Description Wooden coffin. E-W					
Discussion Part of coffins on top of each other.					
Shape, dimensions and distinguishing characteristics					
LID					
HEAD					
BASE					
Recorder: D. H. A. G. L.		Date: 25.9.00		Initials: D.H.	

db.

SITE OLR 00	COFFIN RECORD SHEET	CONTEXT NO. 266
Trench:	Additional sheets: YES X1	Treatment: Bones Collected.
Site sub-div: NC	Grave fills	
Plan no: 3	Grave cut: /	Finds None
Section no:	Skeleton: 266	Breastplate Grip
Co-ordinates:	Matrix location: 0/ices 268	Hinge Bracket
Levels	Preservation: Fnr	Fixing nails Shroud pins
Slide No.	Neg No:	Fabric Other finds

Description
 Wooden coffin burial, E-W.

Discussion
 20 parts of coffins on top of each other, same cut.

Shape, dimensions and distinguishing characteristics

LID

HEAD

BASE

Recorder: D. Hane	Date: 25.9.00	Initials: DH.
--------------------------	----------------------	----------------------

Site Code

Context

Outer Coffin

Sample Ret.

OH200

26b

Recording Date 18/10

Associated Numbers

Condition

Dep. Plate

Legible

Inscription

Fabric lead ormolou brass tin plated pewter gilt tin
 iron silvered tin enamelled other Sample Ret.

Shape of dep. plate

square rectangle shield tapered lozenge
 cartouche oval other

Upholstery

colour shoddy velvet other *boize* Sample Ret.

Construction butt joint mitred pitched other

Grip plate Fabric = ormolou brass tin plated pewter gilt tin
 iron silvered tin enamelled other Sample Ret.







Grip Fabric = ormolou brass iron Sample Ret.

Design swag of rose horseshoe cherub's head plain
 other

Grip bolts **Corner bolts** Type = gilt brass brass iron
 other Sample Ret.

Lid motifs other Sample Ret.

Escutcheons other Sample Ret.

Upholstery nails brass gilt brass silvered brass iron enamelled
 other *1x*  *1x*  *1x*  *1x*  *1x*  *1x*  *could be. 3/4/5/7/8 etc.* Sample Ret.

Fixings panel nails screws hinges lace Sample Ret.

Timber type Sample Ret.

Interpretation / Comments

.....

studs
x 6 pieces. = total of 67 studs.
could be. 3/4/5/7/8 etc.

db

SITE <i>OL R 00</i>		COFFIN RECORD SHEET	CONTEXT NO. <i>267</i>
Trench:		Additional sheets: <i>4E&X1</i>	Treatment: <i>Bones collected.</i>
Site sub-div: <i>NC</i>		Grave fills <i>/</i>	
Plan no: <i>3</i>		Grave cut: <i>/</i>	Finds None
Section no:		Skeleton: <i>267</i>	Breastplate Grip <input checked="" type="checkbox"/>
Co-ordinates:		Matrix location: <i>0/lies 269, u/lies 265</i>	Hinge Bracket <i>up studs</i> Fixing nails
Levels		Preservation: <i>Fair.</i>	Shroud pins
Slide No.		Neg No:	Fabric Other finds :
Description <i>Wooden coffin burial E-W</i>			
Discussion <i>Part of coffin group using same cut.</i>			
Shape, dimensions and distinguishing characteristics			
LID			
HEAD			
BASE			
Recorder: <i>D. Hall</i>	Date: <i>25.9.00</i>	Initials: <i>DH</i>	

Outer Coffin

Sample Ret.

Site Code

Context

ORLOO

267

Recording Date 22/9/00

Associated Numbers

Condition 1

Dep. Plate

Legible

Inscription

Fabric lead ormolou brass tin plated pewter gilt tin
 iron silvered tin enamelled other Sample Ret.

Shape of dep. plate

square rectangle shield tapered lozenge
 cartouche oval other

Upholstery

colour shoddy velvet other Sample Ret.

Construction

butt joint mitred pitched other

Grip plate

Fabric = ormolou brass tin plated pewter gilt tin
frag on rev. of grip - unid.
 iron silvered tin enamelled other Sample Ret.

Grip

Fabric = ormolou brass iron Sample Ret.

Design

swag of rose horseshoe cherub's head plain
4 x fe. grips - split do 1. *ring - grip terminal*

Grip bolts

Corner bolts Type = gilt brass brass iron

other Sample Ret.

Lid motifs

other Sample Ret.

Escutcheons

other Sample Ret.

Upholstery

sheds
 nails brass gilt brass silvered brass iron *3* enamelled
 other Sample Ret.

Fixings

panel nails screws hinges lace Sample Ret.

Timber type

Sample Ret.

Interpretation / Comments

.....

SITE	OLR 00	COFFIN RECORD SHEET	CONTEXT NO.	268	
Trench:		Additional sheets:	YESX1.	Treatment:	Bones collected.
Site sub-div:	NZ	Grave fills	/		
Plan no:	3	Grave cut:	/	Finds	None
Section no:		Skeleton:	268	Breastplate	Grip
Co-ordinates:		Matrix location:	o/wies 266	Hinge	Bracket
Levels		Preservation:	Fair.	Fixing nails	Shroud pins
Slide No.		Neg No:		Fabric	Other finds

Description
 Wooden coffin burial. E-W

Discussion
 Part of coffins using same cut.

Shape, dimensions and distinguishing characteristics

LID

HEAD

BASE

Recorder:	D. Hall	Date:	25.9.00	Initials:	dh
-----------	---------	-------	---------	-----------	----

Coffin Recording Sheet

Site Code

Context

Outer Coffin

Sample Ret.

OH200

268

Recording Date 18/10

Associated Numbers

Condition

Dep. Plate

Legible

Inscription

Fabric lead ormolou brass tin plated pewter gilt tin
 iron silvered tin enamelled other Sample Ret.

Shape of dep. plate

square rectangle shield tapered lozenge
 cartouche oval other

Upholstery

colour shoddy velvet other *Boize* Sample Ret.

Construction butt joint mitred pitched other

Grip plate Fabric = ormolou brass tin plated pewter gilt tin
 iron silvered tin enamelled other Sample Ret.





Grip Fabric = ormolou brass iron Sample Ret.

Design swag of rose horseshoe cherub's head plain
 other

Grip bolts **Corner bolts** Type = gilt brass brass iron
 other

Lid motifs other

Escutcheons other

Upholstery nails brass gilt brass silvered brass iron enamelled
 other *shells* *2 x strips + 1 x  / 1 x  / 1 x  / 1 x  / 1 x * Sample Ret.
x 6 pieces - total studs = 69
could be spHds 3/4/5/7/8 etc.

Fixings panel nails screws hinges lace Sample Ret.

Timber type Sample Ret.

Interpretation / Comments

.....

db

SITE OL R00	COFFIN RECORD SHEET	CONTEXT NO. 269
Trench:	Additional sheets: 4E8X1	Treatment: Bones collected.
Site sub-div: NE	Grave fills -	
Plan no: 3	Grave cut: -	Finds None
Section no:	Skeleton: 269	Breastplate Grip
Co-ordinates:	Matrix location: 0/1ain by 266 , 267.	Hinge Bracket
Levels	Preservation: Fair.	Fixing nails Shroud pins
Slide No.	Neg No:	Fabric Other finds

Description
Wooden coffin burial. E-W

Discussion
Part of coffin burials using same cut, deepest of lot.

Shape, dimensions and distinguishing characteristics

LID

HEAD

BASE

Recorder: D. Howell Date: 25.9.00 Initials: DH

Coffin Recording Sheet

Site Code

Context

OL100

269

Outer Coffin

Sample Ret.

Recording Date 18/10

Associated Numbers

Condition

Dep. Plate

Legible

Inscription fe. x 4 frags - unid.

Fabric lead ormolou brass tin plated pewter gilt tin
 iron silvered tin enamelled other Sample Ret.

Shape of dep. plate

square rectangle shield tapered lozenge
 cartouche oval other

Upholstery

colour shoddy velvet other Beize Sample Ret.

Construction butt joint mitred pitched other

Grip plate Fabric = ormolou brass tin plated pewter gilt tin
 iron silvered tin enamelled other Sample Ret.

Frags on rev. of grip

Grip Fabric = ormolou brass iron x1 Sample Ret.

(30)

Design swag of rose horseshoe cherub's head plain
 other

Grip bolts **Corner bolts** **Type =** gilt brass brass iron
 other Sample Ret.

Lid motifs other Sample Ret.

Escutcheons other Sample Ret.

Upholstery brass gilt brass silvered brass iron enamelled
 other 1 x 88 main dec. pieces = 1 x 88 corner. 1 x 880 1 x 88000000 rest = strips x 12 pieces - total of c.120 Sample Ret.

Fixings panel nails screws hinges lace Sample Ret.

Timber type Sample Ret.

Interpretation / Comments

.....

110

SITE <i>OLR00</i>	COFFIN RECORD SHEET	CONTEXT NO. 270 <i>270</i>
Trench: <i>CRYPT</i>	Additional sheets: <i>NO</i>	Treatment:
Site sub-div:	Grave fills	
Plan no:	Grave cut:	Finds None
Section no:	Skeleton:	Breastplate Grip
Co-ordinates:	Matrix location:	Hinge Bracket
Levels	Preservation: <i>V. Poor</i>	Fixing nails Shroud pins
Slide No.	Neg No:	Fabric Other finds

Description

Discussion

Shape, dimensions and distinguishing characteristics

LID

HEAD

BASE



*disturbed, compacted
vandalised infant
pb. coffin (1.1m long).*

Recorder:

Date:

Initials:

dk.

SITE OLR 00	COFFIN RECORD SHEET	CONTEXT NO. 271
Trench:	Additional sheets:	Treatment: Bones collected.
Site sub-div: NC	Grave fills /	
Plan no: 3	Grave cut: /	Finds None
Section no:	Skeleton: 271	Breastplate Grip
Co-ordinates:	Matrix location: /	Hinge Bracket
Levels	Preservation: Fair.	Fixing nails Shroud pins
Slide No.	Neg No:	Fabric Other finds

Description
Wooden coffin burial. E-W
Top 1/2 only due to edge of section - to be recovered.
RECOVERED 25.9.00

Discussion

Shape, dimensions and distinguishing characteristics

LID

HEAD

BASE

Recorder: D. Hall	Date: 25.9.00	Initials: D.H.
-------------------	---------------	----------------

clb.

SITE <u>OLR00</u>		COFFIN RECORD SHEET	CONTEXT NO. <u>272</u>
Trench:	Additional sheets:	Treatment: <u>Bones collected.</u>	
Site sub-div: <u>NC</u>	Grave fills: <u>/</u>		
Plan no:	Grave cut: <u>/</u>	Finds None	
Section no:	Skeleton: <u>272</u>	Breastplate Grip	
Co-ordinates:	Matrix location: <u>/</u>	Hinge Bracket	
Levels:	Preservation: <u>Fair.</u>	Fixing nails Shroud pins	
Slide No.:	Neg No:	Fabric Other finds :	
Description <u>Wooden coffin burial - skull smashed. E-W</u>			
Discussion			
Shape, dimensions and distinguishing characteristics			
LID			
HEAD			
BASE			
Recorder: <u>D. Hall</u>	Date: <u>25.9.00</u>	Initials: <u>DH</u>	

db.

SITE OLR00	COFFIN RECORD SHEET	CONTEXT NO. 273
Trench:	Additional sheets: YES x1	Treatment: Bones collected.
Site sub-div: NC	Grave fills /	
Plan no: 3	Grave cut: /	Finds None
Section no:	Skeleton: 273	Breastplate Grip
Co-ordinates:	Matrix location: cut into Natural.	Hinge Bracket
Levels	Preservation: Fair.	Fixing nails Shroud pins
Slide No.	Neg No:	Fabric Other finds
Description Top 1/2 recovered at 20.9.00 - under section. E-W orientated		
Discussion		
Shape, dimensions and distinguishing characteristics		
LID		
HEAD		
BASE		
Recorder: D. Hall	Date: 25.9.00	Initials: DH

Site Code

Context

Outer Coffin

Sample Ret.

Orkoo

273

Recording Date *20/9/00*

Associated Numbers

Condition *1*

Dep. Plate

Legible

Inscription

Fabric lead ormolou brass tin plated pewter gilt tin
 iron silvered tin enamelled other Sample Ret.

Shape of dep. plate

square rectangle shield tapered lozenge
 cartouche oval other

Upholstery

colour shoddy velvet other Sample Ret.

Construction

butt joint mitred pitched other

Grip plate Fabric = ormolou brass tin plated pewter gilt tin
 iron silvered tin enamelled other Sample Ret.

Grip Fabric = ormolou brass iron Sample Ret.

Design swag of rose horseshoe cherub's head plain
 other

Grip bolts Corner bolts Type = gilt brass brass iron
 other Sample Ret.

Lid motifs other *fr. plate frag - portion of border area - unid.* Sample Ret.

Escutcheons other Sample Ret.

Upholstery nails brass gilt brass silvered brass iron *x 1 piece* enamelled
 other *corner piece conc. 90° together. Total of 6 studs. - corner 90°* Sample Ret.

Fixings panel nails screws hinges lace Sample Ret.

Timber type Sample Ret.

Interpretation / Comments

.....

db

SITE OLR00	COFFIN RECORD SHEET	CONTEXT NO. 274
Trench:	Additional sheets: YES x1	Treatment: Bones collected.
Site sub-div: NC	Grave fills /	
Plan no: 3	Grave cut: /	Finds None
Section no:	Skeleton: 274	Breastplate Grip
Co-ordinates:	Matrix location: o/L by 275 o/lies 276 + 277	Hinge Bracket
Levels	Preservation: Fair.	Fixing nails Shroud pins
Slide No.	Neg No:	Fabric Other finds

Description
 Brick in lead coffin - no name plate. E-W
 length - 1.5m width c 0.48m. in middle, 0.28m at head end.

Discussion

Shape, dimensions and distinguishing characteristics

LID

HEAD

BASE

Recorder: D. Hall	Date: 25.9.00	Initials: DH
-------------------	---------------	--------------

Coffin Recording Sheet

Site Code

Context

OLK00

274

Outer Coffin

Sample Ret.

Recording Date 17/10

Associated Numbers

Condition

Dep. Plate

Legible

Inscription

Fabric lead ormolou brass tin plated pewter gilt tin
 iron silvered tin enamelled other Sample Ret.

Shape of dep. plate

square rectangle shield tapered lozenge
 cartouche oval other

Upholstery

colour shoddy velvet other Sample Ret.

Construction

butt joint mitred pitched other

Grip plate Fabric = ormolou brass tin plated pewter gilt tin
 iron silvered tin enamelled other Sample Ret.

Grip Fabric = ormolou brass iron Sample Ret.

Design swag of rose horseshoe cherub's head plain
 other

Grip bolts Corner bolts Type = gilt brass brass iron

other Sample Ret.

Lid motifs other Sample Ret.

Escutcheons other Sample Ret.

Upholstery ^{studs} nails brass gilt brass silvered brass iron ^{x 1} _{perce} enamelled
 other ^{oo - 2 studs} Sample Ret.

Fixings panel nails screws hinges lace Sample Ret.

Timber type Sample Ret.

Interpretation / Comments

.....

db.

SITE - OLR 00		COFFIN RECORD SHEET		CONTEXT NO. 275	
Trench:		Additional sheets: YES X 1		Treatment: Bones collected.	
Site sub-div: NC		Grave fills: /			
Plan no: 3		Grave cut: /		Finds	
				None	
Section no:		Skeleton: 275		Breastplate	
				Grip	
Co-ordinates:		Matrix location: okes 274		Hinge	
				Bracket	
Levels		Preservation: good.		Fixing nails	
				Shroud pins	
Slide No.		Neg. No:		Fabric	
				Other finds	
<p>Description: Wooden coffin, buried directly above (274), squashing lead coffin of (274). Poss. mixing of 274 + 275 due to use of machine + proximity - but bones fairly different colours. E-W</p>					
Discussion					
Shape, dimensions and distinguishing characteristics					
LID					
HEAD					
BASE					
Recorder: D. Hall		Date: 25.9.00		Initials: DH	

db.

Coffin Recording Sheet

Site Code

Context

Outer Coffin

Sample Ret.

02100

275

Recording Date

Associated Numbers

Condition

Dep. Plate

Legible

Inscription

Fabric lead ormolou brass tin plated pewter gilt tin
 iron silvered tin enamelled other Sample Ret.

Shape of dep. plate

square rectangle shield tapered lozenge
 cartouche oval other

Upholstery

colour shoddy velvet other Sample Ret.

Construction

butt joint mitred pitched other

Grip plate Fabric = ormolou brass tin plated pewter gilt tin
 iron silvered tin enamelled other Sample Ret.

Grip Fabric = ormolou brass iron Sample Ret.

Design swag of rose horseshoe cherub's head plain

other

Grip bolts Corner bolts Type = gilt brass brass iron

other Sample Ret.

Lid motifs other Sample Ret.

Escutcheons other Sample Ret.

Upholstery ^{studs} nails brass gilt brass silvered brass iron ^{x 3} pieces enamelled
 other *10 studs in total - a db oooooo* Sample Ret.

Fixings panel nails screws hinges lace Sample Ret.

Timber type Sample Ret.

Interpretation / Comments

.....

db

SITE OLR 00		COFFIN RECORD SHEET		CONTEXT NO. 276	
Trench:		Additional sheets:		Treatment: <i>Bones collected.</i>	
Site sub-div: NC		Grave fills <i>—</i>			
Plan no: 3		Grave cut: <i>—</i>		Finds None	
Section no:		Skeleton: 276		Breastplate Grip	
Co-ordinates:		Matrix location: <i>0/6m by 275.</i>		Hinge Bracket	
Levels		Preservation: <i>Top half only at 20.9.00 to humeri. ALL COLLECTED ON 22.9.00.</i>		Fixing nails Shroud pins	
Slide No.		Neg No:		Fabric Other finds	
Description <i>Quite deep, some possible mixing with 277 due to removal by bucket. E-W</i>					
Discussion					
Shape, dimensions and distinguishing characteristics					
LID					
HEAD					
BASE					
Recorder: <i>D.Hall</i>		Date: <i>25.9.00</i>		Initials: <i>DH</i>	

db

SITE <u>OLR 00</u>		COFFIN RECORD SHEET	CONTEXT NO. <u>277</u>
Trench:	Additional sheets: <u>YES x 1</u>	Treatment: <u>Bones collected.</u>	
Site sub-div: <u>NC</u>	Grave fills: <u>—</u>		
Plan no: <u>3</u>	Grave cut: <u>—</u>	Finds None	
Section no:	Skeleton: <u>277</u>	Breastplate Grip <input checked="" type="checkbox"/>	
Co-ordinates:	Matrix location: OLR 275 <u>OLR by 275.</u>	Hinge Bracket	
Levels	Preservation: <u>ALL COLLECTED 22.9.00.</u> <u>Fair.</u>	Fixing nails Shroud pins	
Slide No.	Neg No:	Fabric Other finds	
Description <u>Poss. mingling with 276 due to removal by bucket.</u> <u>Top half of body only out 20.9.00. E-W.</u> <u>ALL COLLECTED 22.9.00</u>			
Discussion			
Shape, dimensions and distinguishing characteristics			
LID			
HEAD			
BASE			
Recorder: <u>O. Hall</u>	Date: <u>25.9.00</u>	Initials: <u>DA</u>	

Coffin Recording Sheet

Outer Coffin

Sample Ret.

Site Code

Context

01200

277

Recording Date 21/9/00

Associated Numbers

Condition 1

Dep. Plate

Legible

Inscription

Fabric lead ormolou brass tin plated pewter gilt tin
 iron silvered tin enamelled other Sample Ret.

Shape of dep. plate

square rectangle shield tapered lozenge
 cartouche oval other

Upholstery

colour shoddy velvet other Sample Ret.

Construction

butt joint mitred pitched other

Grip plate Fabric = ormolou brass tin plated pewter gilt tin

iron silvered tin enamelled other Sample Ret.

frag on rev. of grip - unid.

Grip Fabric = ormolou brass iron x 2 Sample Ret.

Design swag of rose horseshoe cherub's head plain

other *badly conc. perb. spltdo 1.*

Grip bolts **Corner bolts** **Type =** gilt brass brass iron

other Sample Ret.

Lid motifs other Sample Ret.

Escutcheons other Sample Ret.

Upholstery nails brass gilt brass silvered brass iron enamelled

other Sample Ret.

Fixings panel nails screws hinges lace Sample Ret.

Timber type Sample Ret.

Interpretation / Comments

.....

dbb

SITE OLR 00		COFFIN RECORD SHEET	CONTEXT NO. 278
Trench:		Additional sheets: YES x2	Treatment: Bones collected.
Site sub-div: NC		Grave fills /	
Plan no: 3		Grave cut: /	Finds None
Section no:		Skeleton: 278	Breastplate Grip <input checked="" type="checkbox"/>
Co-ordinates:		Matrix location: 0/wes 279	Hinge Bracket <i>up studs</i>
Levels		Preservation: Good.	Fixing nails <input checked="" type="checkbox"/> Shroud pins
Slide No.		Neg No:	Fabric Other finds
Description Wooden coffin, E-W. Poss. mixing due to proximity with 279.			
Discussion			
Shape, dimensions and distinguishing characteristics			
LID			
HEAD			
BASE			
Recorder: D. Hall		Date: 25.9.00	Initials: DB

Coffin Recording Sheet

Site Code

Context

Outer Coffin

Sample Ret.

OR00

278

Recording Date 21/9/00

Associated Numbers

Condition

Dep. Plate

Legible

Inscription

Fabric lead ormolou brass tin plated pewter gilt tin
 iron silvered tin enamelled other Sample Ret.

Shape of dep. plate

square rectangle shield tapered lozenge
 cartouche oval other

Upholstery

colour shoddy velvet other Sample Ret.

Construction

butt joint mitred pitched other

Grip plate Fabric = ormolou brass tin plated pewter gilt tin
 iron *fact.* silvered tin enamelled other Sample Ret.

Grip Fabric = ormolou brass iron 3 Sample Ret.

Design swag of rose horseshoe cherub's head plain
 other

Grip bolts Corner bolts Type = gilt brass brass iron
 other Sample Ret.

Lid motifs other Sample Ret.

Escutcheons other Sample Ret.

Upholstery ^{studs} nails brass gilt brass silvered brass iron enamelled
 other Sample Ret.

Fixings panel nails screws hinges lace Sample Ret.

Timber type Sample Ret.

Interpretation / Comments

.....

cont.

grips x 3 - fe w/ squared-off returns - too conc. to determine overall shape. Poss. similar to Spttds 3b? Traces of fe. grip plate adhering to reverse of one, but again too conc. to identify.

up. studs x 6 pieces: all still in situ in coffin wood.

piece a) 5 x studs



b) 10 x studs

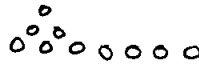

c) 2 x studs



d) 3 x studs



e) 30 x studs - Head/food lid corner?



f) 40 x studs - w/ fe nail - lid?

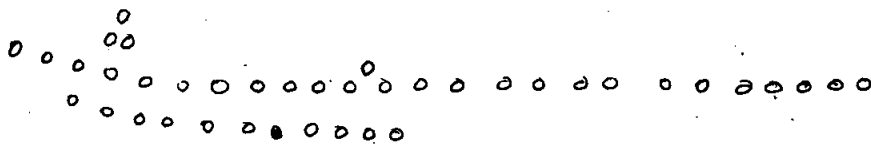

(
fe nail

db

SITE <i>06200</i>	COFFIN RECORD SHEET	CONTEXT NO. <i>279</i>
Trench:	Additional sheets: <i>YES x1.</i>	Treatment: <i>Bones collected.</i>
Site sub-div: <i>NC</i>	Grave fills <i>/</i>	
Plan no: <i>3</i>	Grave cut: <i>/</i>	Finds None
Section no:	Skeleton: <i>279</i>	Breastplate Grip
Co-ordinates:	Matrix location: <i>lies 278.</i>	Hinge Bracket
Levels	Preservation: <i>Good - largely complete.</i>	Fixing nails Shroud pins
Slide No.	Neg No:	Fabric Other finds

Description *E-W*

Discussion

Shape, dimensions and distinguishing characteristics

LID

HEAD

BASE

Recorder: <i>D. Hall</i>	Date: <i>25.9.00</i>	Initials: <i>DH</i>
--------------------------	----------------------	---------------------

Outer Coffin

Sample Ret.

Site Code

Context

OLR00

~~279~~
279

Recording Date

Associated Numbers

Condition

Dep. Plate

Legible

Inscription

Fabric lead ormolou brass tin plated pewter gilt tin
 iron silvered tin enamelled other Sample Ret.

Shape of dep. plate

square rectangle shield tapered lozenge
 cartouche oval other

Upholstery

colour shoddy velvet other Sample Ret.

Construction butt joint mitred pitched other

Grip plate Fabric = ormolou brass tin plated pewter gilt tin
frag on rev. of grip
 iron silvered tin enamelled other Sample Ret.

Grip Fabric = ormolou brass iron x 3 Sample Ret.

Design swag of rose horseshoe cherub's head plain
 other *Sprts 3b. badly conc.*

Grip bolts **Corner bolts** **Type =** gilt brass brass iron
 other Sample Ret.

Lid motifs other Sample Ret.

Escutcheons other Sample Ret.

Upholstery nails brass gilt brass silvered brass iron enamelled
 other Sample Ret.

Fixings panel nails screws hinges lace Sample Ret.

Timber type Sample Ret.

Interpretation / Comments

.....

db.

SITE 0L200		COFFIN RECORD SHEET	CONTEXT NO. 280.
Trench:	Additional sheets:	Treatment: All bones collected at 21.09.00	
Site sub-div: NC	Grave fills: /		
Plan no: 3	Grave cut: /	Finds None	
Section no:	Skeleton: 280	Breastplate Grip	
Co-ordinates:	Matrix location: None In association with 293 + 294.	Hinge Bracket	
Levels:	Preservation: Good - THIBS + FEET under section at 20.9.00	Fixing nails Shroud pins	
Slide No. film 20.	Neg No:	Fabric Other finds:	
Description E-W. Poss. some mixing with charnal remains. Wooden coffin.			
Discussion			
Shape, dimensions and distinguishing characteristics			
LID			
HEAD			
BASE			
Recorder: D. Hall	Date: 25.9.00	Initials: DH	

db.

SITE		COFFIN RECORD SHEET		CONTEXT NO.	
OLR00				281	
Trench:		Additional sheets: YES x 1.		Treatment: Bones collected.	
Site sub-div: NC		Grave fills: -			
Plan no: 3		Grave cut: -		Finds: None	
Section no:		Skeleton: 281		Breastplate: Grip	
Co-ordinates:		Matrix location: 0/ies 282		Hinge: Bracket	
Levels:		Preservation: Good. DNA Sampled.		Fixing nails: Shroud pins	
Slide No.:		Neg No.:		Fabric: Other finds:	
Description E-W. Lead Coffin with nameplate of Noah Nicholls. L-2m x W-0.4m D-unknown. 9 28.9.1837					
Discussion					
Shape, dimensions and distinguishing characteristics					
LID					
HEAD					
BASE					
Recorder: D Hall		Date: 25.9.02		Initials: DH	

Coffin Recording Sheet

Outer Coffin

Sample Ret.

Site Code

Context

Orloo

281

Recording Date *23/10*

Associated Numbers

Condition

Dep. Plate

Legible

Inscription *"Mr / Noah Nicholls / Died 28th Sept / 1837 / in his 57th year."*

Fabric lead ormolou brass tin plated pewter gilt tin
 iron silvered tin enamelled other Sample Ret.

Shape of dep. plate

square rectangle shield tapered lozenge
 cartouche oval other *Black polished (21) w/ 534 outer border.*

Upholstery

colour shoddy velvet other Sample Ret.

Construction

butt joint mitred pitched other

Grip plate

Fabric = ormolou brass tin plated pewter gilt tin
 iron silvered tin enamelled other Sample Ret.

Grip

Fabric = ormolou brass iron Sample Ret.

Design

swag of rose horseshoe cherub's head plain
 other

Grip bolts

Corner bolts Type = gilt brass brass iron
 other Sample Ret.

Lid motifs

other Sample Ret.

Escutcheons

other Sample Ret.

Upholstery nails

brass gilt brass silvered brass iron enamelled
 other Sample Ret.

Fixings

panel nails screws hinges lace Sample Ret.

Timber type

Sample Ret.

Interpretation / Comments

.....

db.

SITE	COFFIN RECORD SHEET	CONTEXT NO.
0LR00		282
Trench:	Additional sheets:	Treatment: Bones collected.
Site sub-div: Nc	Grave fills =	
Plan no: 3	Grave cut: —	Finds
Section no:	Skeleton: 282	None
Co-ordinates:	Matrix location: o/lain by 281	Breastplate
Levels	Preservation: Good	Grip
Slide No.	Neg No:	Hinge
Description E-W burial below 281, old person - good collection quality.		Bracket
Discussion		Fixing nails
Shape, dimensions and distinguishing characteristics		Shroud pins
Recorder: D. Hall		Fabric
Date: 25.9.00		Other finds
		:

Coffin Recording Sheet

Site Code

Context

OLR00

282

Outer Coffin

Sample Ret.

Recording Date 21/9/00

Associated Numbers

Condition

Dep. Plate

Legible

Inscription

Fabric lead ormolou brass tin plated pewter gilt tin
 iron silvered tin enamelled other Sample Ret.

Shape of dep. plate

square rectangle shield tapered lozenge
 cartouche oval other

Upholstery

colour shoddy velvet other *ferrous textile on REV. of grip plate frag.* Sample Ret.

Construction

butt joint mitred pitched other

Grip plate Fabric = ormolou brass tin plated pewter gilt tin
 iron silvered tin enamelled other Sample Ret.
1x frag on REV. of grip

Grip Fabric = ormolou brass iron X3 Sample Ret.

Design swag of rose horseshoe cherub's head plain

other *heavily conc. prob. plain sptfels 1.*

Grip bolts **Corner bolts** Type = gilt brass brass iron

other Sample Ret.

Lid motifs other Sample Ret.

Escutcheons other Sample Ret.

Upholstery nails brass gilt brass silvered brass iron X4 enamelled

other *4 x fe. up. studs in strip - no wood, conc. together.* Sample Ret.

Fixings panel nails screws hinges lace Sample Ret.

Timber type Sample Ret.

Interpretation / Comments

.....

db.

SITE	OLR 00	COFFIN RECORD SHEET	CONTEXT NO.	283
Trench:		Additional sheets:	Treatment: Bones collected.	
Site sub-div:	NC	Grave fills	-	
Plan no:	3	Grave cut:	-	
Section no:		Skeleton:	283	
Co-ordinates:		Matrix location:	o/wes 284, 287, 288.	
Levels		Preservation:		
Slide No.		Neg No:		
Description		& Child Skeleton, mixed parts with 293 + 294. No clear relationship between 283, 293 + 294, all mixed. But clearly separate interments + articulation.		
Discussion				
Shape, dimensions and distinguishing characteristics				
LID				
HEAD				
BASE				
Recorder:	D. Hall	Date:	25.9.00	Initials:
				dt

dp.

SITE OLR 00		COFFIN RECORD SHEET		CONTEXT NO. 284	
Trench:		Additional sheets: YES x2.		Treatment: Bones collected.	
Site sub-div: NC		Grave fills: -		DNA <input checked="" type="checkbox"/>	
Plan no: 3		Grave cut: -		Finds	
Section no:		Skeleton: 284		None	
Co-ordinates:		Matrix location: uplies 283 obtained by 287+288		Breastplate	
Levels		Preservation: Fair. DNA Sampled.		Grip	
Slide No.		Neg No:		Hinge	
Description		E-W. wooden coffin with nameplate Barbara Holyland aged 35.		Bracket	
Discussion				Fixing nails	
Shape, dimensions and distinguishing characteristics				Shroud pins	
LID				Fabric	
HEAD				Other finds	
BASE					
Recorder: D. Hall		Date: 25.9.00		Initials: DH	

Site Code

Context

Outer Coffin

Sample Ret.

OLR00

284

Recording Date 24/10

Associated Numbers

Condition *3*

Dep. Plate

Legible

Inscription *"Mrs/ Barbara Holyland / Died 29th July / 1783 / Aged 35 Years"*

Fabric lead ormolou brass tin plated pewter gilt tin
 iron silvered tin enamelled other Sample Ret.

Shape of dep. plate

square rectangle shield tapered lozenge
 cartouche oval other *Sptlds (64) w/ minor differences. (see over) (flowers)*

Upholstery

colour shoddy velvet other Sample Ret.

Construction

butt joint mitred pitched other

Grip plate

Fabric = ormolou brass tin plated pewter gilt tin
Flaps of Rev. on grips
 iron silvered tin enamelled other Sample Ret.

Grip

Fabric = ormolou brass iron *x3* Sample Ret.

Design

swag of rose horseshoe cherub's head plain

other *①'s*

Grip bolts

Corner bolts Type = gilt brass brass iron

other Sample Ret.

Lid motifs

other Sample Ret.

Escutcheons

other Sample Ret.

Upholstery *studs*

nails brass gilt brass silvered brass iron *x2 single studs.* enamelled

other Sample Ret.

Fixings

panel nails screws hinges lace Sample Ret.

Timber type

Sample Ret.

Interpretation / Comments

.....

< 0.33 >

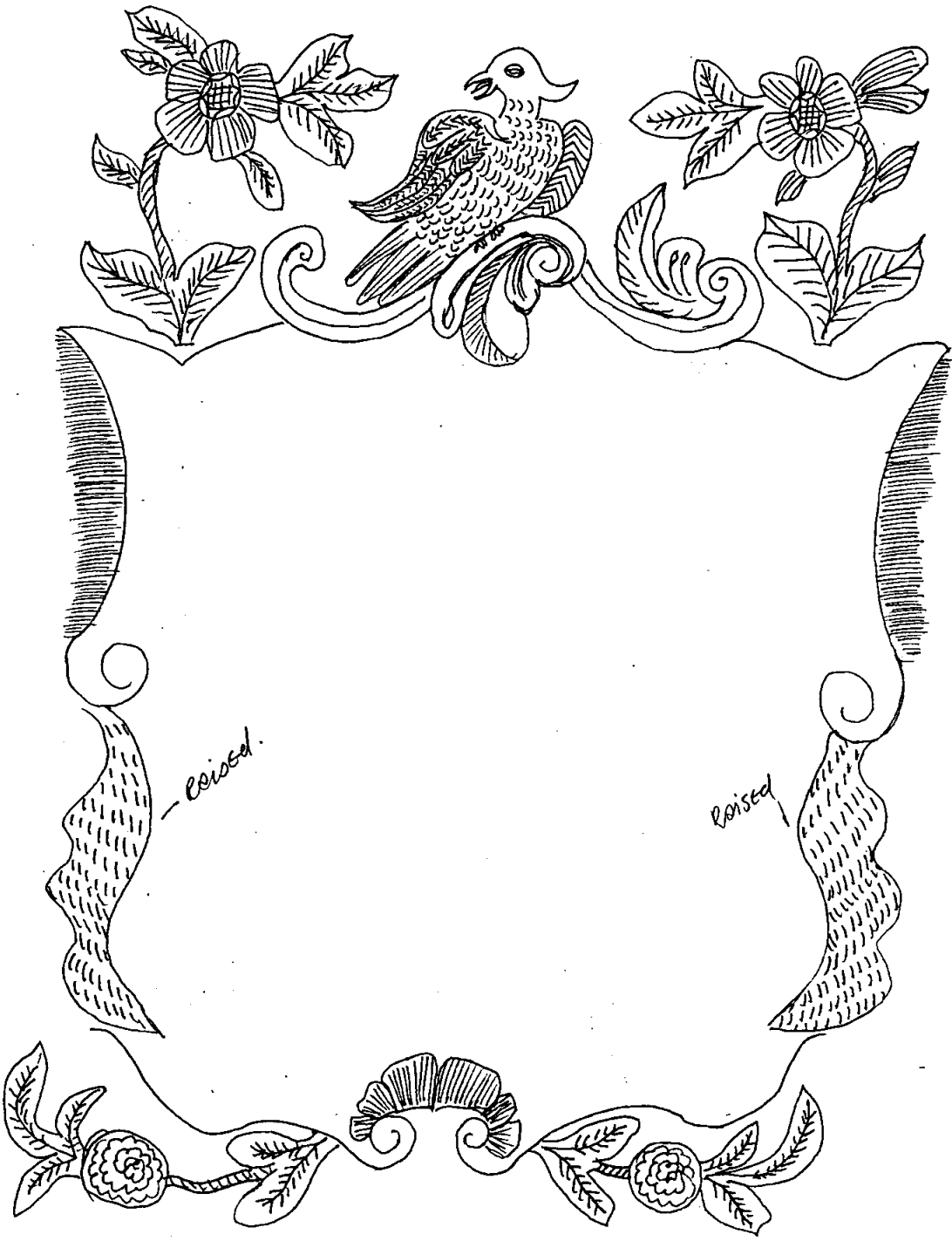

1

raised.

raised

0.44

both borders exactly the same as (rect) 64.

db.

SITE OLR 00		COFFIN RECORD SHEET		CONTEXT NO. 285	
Trench:		Additional sheets:		Treatment: Bones collected.	
Site sub-div: NC		Grave fills			
Plan no: 3		Grave cut: —		Finds None	
Section no:		Skeleton: —		Breastplate Grip	
Co-ordinates:		Matrix location: u/lies 286 + truncated by 286		Hinge Bracket	
Levels		Preservation: Good - legs to be collected at 22.9.00		Fixing nails Shroud pins	
Slide No.		Neg No:		Fabric Other finds	
Description E-W. skull + some upper body, truncated by 286 - rest of body to collect in next strip.					
Discussion					
Shape, dimensions and distinguishing characteristics					
LID					
HEAD					
BASE					
Recorder: D. Hall		Date: 25.9.00		Initials: DH	

clb

SITE OLR 00	COFFIN RECORD SHEET	CONTEXT NO. 286
Trench:	Additional sheets:	Treatment: Bones collected.
Site sub-div: NC	Grave fills: -	
Plan no: 3	Grave cut: -	Finds None
Section no:	Skeleton: 286	Breastplate Grip
Co-ordinates:	Matrix location: o/lies 285.	Hinge Bracket
Levels	Preservation: Poor.	Fixing nails Shroud pins
Slide No.	Neg No:	Fabric Other finds
<p>Description that Baby burial. truncating 285, only 2 bones present, rest presumably rotted away.</p> <p>Discussion</p>		
<p>Shape, dimensions and distinguishing characteristics</p> <p>LID</p> <p>HEAD</p> <p>BASE</p>		
Recorder: D. Hall	Date: 25.9.00	Initials: DH

db.

SITE OLR 50		COFFIN RECORD SHEET	CONTEXT NO. 287
Trench:	Additional sheets:	Treatment: <i>Bones collected.</i>	
Site sub-div: NC	Grave fills -		
Plan no: 3	Grave cut: ✓	Finds None	
Section no:	Skeleton: 287	Breastplate Grip	
Co-ordinates:	Matrix location: 0/Wes 284.	Hinge Bracket	
Levels	Preservation: Fair	Fixing nails Shroud pins	
Slide No.	Neg No:	Fabric Other finds	

Description *Baby burial.*

Discussion

Shape, dimensions and distinguishing characteristics

LID

HEAD

BASE

Recorder: *D Hall*

Date: *25.9.00*

Initials: *DH*

db

SITE		COFFIN RECORD SHEET		CONTEXT NO.	
OLR 00				288	
Trench:		Additional sheets:		Treatment: Bones collected.	
Site sub-div: NC		Grave fills: -			
Plan no: 3		Grave cut: -		Finds	
				None	
Section no:		Skeleton: 288		Breastplate	
				Grip	
Co-ordinates:		Matrix location: o/lies 284,		Hinge	
				Bracket	
Levels		Preservation: Rev.		Fixing nails	
				Shroud pins	
Slide No.		Neg No:		Fabric	
				Other finds	
				:	
Description: child burial.					
Discussion					
Shape, dimensions and distinguishing characteristics					
LID					
HEAD					
BASE					
Recorder: D. Hall		Date: 25.9.00		Initials: DH	

db

SITE OLR:00	COFFIN RECORD SHEET	CONTEXT NO. 289.
Trench:	Additional sheets: YES X1	Treatment: Bones collected.
Site sub-div: NC	Grave fills —	
Plan no: 3	Grave cut: —	Finds None
Section no:	Skeleton: 289	Breastplate Grip
Co-ordinates:	Matrix location: o/wes 290	Hinge Bracket
Levels	Preservation: Fair.	Fixing nails Shroud pins
Slide No.	Neg No:	Fabric Other finds

Description E-W. Wooden coffin, handles + nails retrieved.

Discussion

Shape, dimensions and distinguishing characteristics

LID

HEAD

BASE

Recorder: D. Hall	Date: 25.9.00	Initials: D.H.
-------------------	---------------	----------------

Site Code

Context

Sample Ret.

Recording Date 10/10

Associated Numbers

Condition Dep. Plate Legible

Inscription

Fabric lead ormolou brass tin plated pewter gilt tin
 iron silvered tin enamelled other Sample Ret.

Shape of dep. plate

square rectangle shield tapered lozenge
 cartouche oval other

Upholstery

colour shoddy velvet other Sample Ret.

Construction butt joint mitred pitched other

Grip plate Fabric = ormolou brass tin plated pewter gilt tin
 iron silvered tin enamelled other Sample Ret.

Grip Fabric = ormolou brass iron **3b** Sample Ret.

Design swag of rose horseshoe cherub's head plain
 other

Grip bolts **Corner bolts** **Type =** gilt brass brass iron
 other Sample Ret.

Lid motifs other Sample Ret.

Escutcheons other Sample Ret.

Upholstery ^{nails} brass gilt brass silvered brass iron enamelled
 other ^{sheds} 1 x 000 1 x 0000 ^{x 2 pieces} Sample Ret.

Fixings panel nails screws hinges lace Sample Ret.

Timber type Sample Ret.

Interpretation / Comments

.....

.....

289

db.

SITE OLR 00	COFFIN RECORD SHEET	CONTEXT NO. 290
Trench:	Additional sheets: YES x 2	Treatment: Bones collected.
Site sub-div: NC.	Grave fills —	
Plan no: 3	Grave cut: —	Finds None
Section no:	Skeleton: 290	Breastplate Grip
Co-ordinates:	Matrix location: u/lies 289 o/lies 291.	Hinge Bracket
Levels	Preservation: B Good.	Fixing nails Shroud pins
Slide No.	Neg No:	Fabric Other finds

Description E-W. Wooden coffin, nameplate. -illegible.

Discussion

Shape, dimensions and distinguishing characteristics

LID

HEAD

BASE

Recorder: D Hall	Date: 25.9.00	Initials: DH
------------------	---------------	--------------

Coffin Recording Sheet

Outer Coffin

Sample Ret.

Site Code

Context

Recording Date 29/9/00

61200

290

Associated Numbers

Condition 1

Dep. Plate

Legible

Inscription illegible - from N.C.

Fabric lead ormolou brass tin plated pewter gilt tin
 iron silvered tin enamelled other Sample Ret.
black.

Shape of dep. plate

square rectangle shield tapered lozenge
 cartouche oval other *prob. sptfds (21)*

Upholstery

colour shoddy velvet other Sample Ret.

Construction

butt joint mitred pitched other

Grip plate

Fabric = ormolou brass tin plated pewter gilt tin
 iron silvered tin enamelled other Sample Ret.
fraggs on rev. of grip

Grip

Fabric = ormolou brass iron 2 Sample Ret.

Design

swag of rose horseshoe cherub's head *sptfds (A)* plain

other

Grip bolts

Corner bolts Type = gilt brass brass iron

other Sample Ret.

Lid motifs

other Sample Ret.

Escutcheons

other Sample Ret.

Upholstery

studs nails brass gilt brass silvered brass iron *x3 pieces* enamelled
 other o oooo oooooooo Sample Ret.

Fixings

panel nails screws hinges lace Sample Ret.

Timber type

Sample Ret.

Interpretation / Comments

.....

dtb.

SITE OLR 00		COFFIN RECORD SHEET		CONTEXT NO. 291	
Trench:		Additional sheets: YES x 1.		Treatment: Bones collected.	
Site sub-div: NC		Grave fills: -			
Plan no: 3		Grave cut: -		Finds	
Section no:		Skeleton: 291		None	
Co-ordinates:		Matrix location: 0/wes 290 0/wes 292		Breastplate	
Levels:		Preservation: Good.		Grip	
Slide No.:		Neg No.:		Hinge	
				Bracket	
				Fixing nails	
				Shroud pins	
				Fabric	
				Other finds	
Description E-W, wooden coffin with nameplate.					
Discussion					
Shape, dimensions and distinguishing characteristics					
LID					
HEAD					
BASE					
Recorder: D. Hall		Date: 25.9		Initials: dtb	

Coffin Recording Sheet

Site Code

Context

Ohloo

291

Outer Coffin

Sample Ret.

Recording Date 18/10

Associated Numbers

Condition

Dep. Plate

Legible ? ish. - oxidised in middle

Inscription

p.b. Rect. (82)

"Mr/...n.../Died... Jan 25/ 1826/ In his 65th year"

Fabric lead ormolou brass tin plated pewter gilt tin
 iron silvered tin enamelled other Sample Ret.

Shape of dep. plate

square rectangle shield tapered lozenge
 cartouche oval other

Upholstery

colour shoddy velvet other Sample Ret.

Construction

butt joint mitred pitched other

Grip plate Fabric = ormolou brass tin plated pewter gilt tin
 iron silvered tin enamelled other Sample Ret.

Grip Fabric = ormolou brass iron Sample Ret.

Design swag of rose horseshoe cherub's head (4) spfils. plain
 other

Grip bolts Corner bolts Type = gilt brass brass iron
 other Sample Ret.

Lid motifs other Sample Ret.

Escutcheons other Sample Ret.

Upholstery nails brass gilt brass silvered brass iron enamelled
 other Sample Ret.

Fixings panel nails screws hinges lace Sample Ret.

Timber type Sample Ret.

Interpretation / Comments

.....

db

SITE OLR 00		COFFIN RECORD SHEET	CONTEXT NO. 292
Trench:	Additional sheets:		Treatment: <i>Bones collected.</i>
Site sub-div: NC	Grave fills —		
Plan no: 3	Grave cut: —		Finds None
Section no:	Skeleton: 292		Breastplate Grip
Co-ordinates:	Matrix location: u/ces 291		Hinge Bracket
Levels	Preservation: fair.		Fixing nails Shroud pins
Slide No.	Neg No:		Fabric Other finds

Description *Appears to be baby burial, but some adult remains also - perhaps truncating 291, 290 + 289 slightly? Or remains may be charnal from previous interments.*

Discussion

Shape, dimensions and distinguishing characteristics

LID

HEAD

BASE

Recorder: D. Hall	Date: 25-9	Initials: <i>[Signature]</i>
--------------------------	-------------------	------------------------------

db

SITE OLR 00	COFFIN RECORD SHEET	CONTEXT NO. 293
Trench:	Additional sheets:	Treatment: Bones collected.
Site sub-div: NC	Grave fills —	
Plan no: 3	Grave cut: —	Finds None
Section no:	Skeleton: 293	Breastplate Grip
Co-ordinates:	Matrix location: assoc. with 280. + 294	Hinge Bracket
Levels	Preservation: Fair.	Fixing nails Shroud pins
Slide No.	Neg No:	Fabric Other finds
Description Baby/child burial associated with 280 + 294, but exact relationship uncertain.		
Discussion		
Shape, dimensions and distinguishing characteristics		
LID		
HEAD		
BASE		
Recorder: D. Hall	Date: 25.9.	Initials: D.H.

db.

SITE		COFFIN RECORD SHEET		CONTEXT NO.	
02R 00				294	
Trench:	Additional sheets:		Treatment: Bones collected.		
Site sub-div: NZ	Grave fills /				
Plan no: 3	Grave cut: /		Finds		
Section no:	Skeleton: 294		None		
Co-ordinates:	Matrix location: Assoc. with 280 + 293.		Breastplate		
Levels	Preservation: Fair.		Grip		
Slide No.	Neg No:		Hinge		
Description		child/baby burial, associated with 280 + 294 - but relationship uncertain.			
Discussion					
Shape, dimensions and distinguishing characteristics					
LID					
HEAD					
BASE					
Recorder: D. Hall	Date: 25.9.		Initials: DH		

db

SITE	COFFIN RECORD SHEET	CONTEXT NO.
OLR 00		295
Trench:	Additional sheets:	Treatment: Bones collected.
Site sub-div: NC	Grave fills —	
Plan no: 3	Grave cut: —	Finds
Section no:	Skeleton: 295	None
Co-ordinates:	Matrix location: Truncated by 297	Breastplate
Levels	Preservation: Poor.	Grip
Slide No.	Neg No:	Hinge
Description	A skull skull, truncated by 297 + ended up in backfill.	
Discussion		
Shape, dimensions and distinguishing characteristics		
LID		
HEAD		
BASE		
Recorder: D. Hall	Date: 25.9.	Initials: DH

db

SITE OLR 00		COFFIN RECORD SHEET		CONTEXT NO. 296	
Trench:		Additional sheets:		Treatment: Bones collected.	
Site sub-div: NZ		Grave fills: —			
Plan no: 3		Grave cut: —		Finds None	
Section no:		Skeleton: 296		Breastplate Grip	
Co-ordinates:		Matrix location: Truncated by 297.		Hinge Bracket	
Levels:		Preservation: Poor.		Fixing nails Shroud pins	
Slide No.:		Neg No.:		Fabric Other finds	
Description Skull, truncated by 297, + ended up in backfill of this grave.					
Discussion					
Shape, dimensions and distinguishing characteristics					
LID					
HEAD					
BASE					
Recorder: D. Hall		Date: 25.9.00		Initials: DH	

db

SITE	COFFIN RECORD SHEET	CONTEXT NO.
OLR 00	Additional sheets: YES X 1	297 Treatment: Bones collected.
Trench:	Grave fills —	
Site sub-div: NL	Grave cut: —	Finds
Plan no: 3	Skeleton: 297	None
Section no:	Matrix location: Truncates/U/L 295 + 296.	Breastplate Grip ✓ e plate
Co-ordinates:	Preservation: lower legs + arms only.	Hinge Bracket up studs ✓ Fixing nails ✓
Levels	Neg No:	Shroud pins
Slide No.	Fabric	Other finds
Description E-W, possibly 295 or 296 is skull for this body - but no clear articulation of the two.		
Discussion		
Shape, dimensions and distinguishing characteristics		
LID		
HEAD		
BASE		
Recorder: D. Hall	Date: 25.9.00	Initials: OA

Site Code

Context

Outer Coffin

Sample Ret.

Orloo

297

Recording Date *22/9/00*

Associated Numbers

Condition *1*

Dep. Plate

Legible

Inscription

Fabric lead ormolou brass tin plated pewter gilt tin
 iron silvered tin enamelled other Sample Ret.

Shape of dep. plate

square rectangle shield tapered lozenge
 cartouche oval other

Upholstery

colour shoddy velvet other Sample Ret.

Construction

butt joint mitred pitched other

Grip plate

Fabric = ormolou brass tin plated pewter gilt tin

iron silvered tin enamelled other Sample Ret.

fraggs on rev. of grip - unid.

Grip

Fabric = ormolou brass iron 2 Sample Ret.

Design

swag of rose horseshoe cherub's head 1 plain 1

other *1 x sptbld 1 + 1 x sptbld A - v. conc.*

Grip bolts

Corner bolts Type = gilt brass brass iron

other Sample Ret.

Lid motifs

other Sample Ret.

Escutcheons

other Sample Ret.

Upholstery

studs
 nails brass gilt brass silvered brass iron enamelled

other *1 x piece - strip of 5 x studs* Sample Ret.

Fixings

panel nails screws hinges lace Sample Ret.

Timber type

Sample Ret.

Interpretation / Comments

.....

db

SITE OLR 00		COFFIN RECORD SHEET		CONTEXT NO. 298	
Trench:		Additional sheets: YES x1.		Treatment: Bones collected.	
Site sub-div: NC		Grave fills —			
Plan no: 3		Grave cut: —		Finds	
Section no:		Skeleton: 298		None	
Co-ordinates:		Matrix location: o/hes 312		Breastplate	
Levels:		Preservation: Fair/Good.		Grip	
Slide No.:		Neg No.:		Hinge	
				Bracket	
				Fixing nails	
				Shroud pins	
				Fabric	
				Other finds	
Description Much charred remains around this burial - 3 skulls, 3 femurs, 2 Tibiae.					
Discussion					
Shape, dimensions and distinguishing characteristics					
LID					
HEAD					
BASE					
Recorder: D. H. M.		Date: 25.9.		Initials: DH	

Site Code

Context

Outer Coffin

Sample Ret.

ORCOO

298

Recording Date 19/10

Associated Numbers

Condition

Dep. Plate

Legible

Inscription

Fabric lead ormolou brass tin plated pewter gilt tin
 iron silvered tin enamelled other Sample Ret.

Shape of dep. plate

square rectangle shield tapered lozenge
 cartouche oval other

Upholstery

colour shoddy velvet other Sample Ret.

Construction

butt joint mitred pitched other

Grip plate

Fabric = ormolou brass tin plated pewter gilt tin
 iron silvered tin enamelled other Sample Ret.
Fraggs on Rev. of grip

Grip

Fabric = ormolou brass iron *x4* Sample Ret.

Design

swag of rose horseshoe cherub's head plain

other *boddy conc. plain grips ①.*

Grip bolts

Corner bolts Type = gilt brass brass iron

other Sample Ret.

Lid motifs

other Sample Ret.

Escutcheons

other Sample Ret.

Upholstery

sheds nails brass gilt brass silvered brass iron *x2 peints* enamelled
 other *1x 000 / 1x 000000* Sample Ret.

Fixings

panel nails screws hinges lace Sample Ret.

Timber type

Sample Ret.

Interpretation / Comments

.....

db

SITE <i>02800</i>	COFFIN RECORD SHEET	CONTEXT NO. <i>299</i>
Trench: <i>crypt</i>	Additional sheets: <i>NO</i>	Treatment:
Site sub-div:	Grave fills	
Plan no: <i>7</i>	Grave cut:	Finds None
Section no:	Skeleton:	Breastplate <input checked="" type="checkbox"/> Grip
Co-ordinates:	Matrix location:	Hinge Bracket
Levels	Preservation: <i>INTACT</i>	Fixing nails Shroud pins
Slide No.	Neg No:	Fabric Other finds

Description

Discussion

Shape, dimensions and distinguishing characteristics

intact p.b. coffin.

299 - 2 x p.b. dep. plates

- a. - orig. on. outer case.*
- b. - soldered onto p.b. coff.*

*"Miss Margaret
Willemine Choape
born 6th July
1836
died 3rd April
1838"*

LID

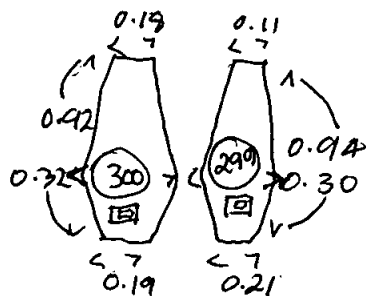

HEAD

BASE

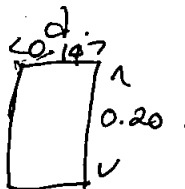

~~300~~
299 0.22 deep
300 0.20 deep

Recorder:	Date:	Initials:
-----------	-------	-----------

db

SITE	COFFIN RECORD SHEET	CONTEXT NO.
OLR00		300
Trench: <i>CRYPT</i>	Additional sheets: <i>No</i>	Treatment: <i>INTACT</i>
Site sub-div:	Grave fills	
Plan no: <i>7</i>	Grave cut:	Finds None
Section no:	Skeleton:	Breastplate <input checked="" type="checkbox"/> Grip
Co-ordinates:	Matrix location:	Hinge Bracket
Levels	Preservation: <i>INTACT</i>	Fixing nails Shroud pins
Slide No.	Neg No:	Fabric Other finds

Description

Discussion

Shape, dimensions and distinguishing characteristics

LID

See 299
for sketch

2 x plates

a - p.b. origin outer wooden case.

b - p.b. soldered into p.b.

HEAD

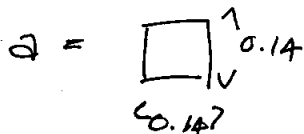

"Lindsey Saesh
Cheape.

Born 28th Sep
1839

Died 1st Nov
1841"

BASE

Recorder:

Date:

Initials:

db

SITE	COFFIN RECORD SHEET	CONTEXT NO.
OLR00		301
Trench: crypt	Additional sheets:	Treatment:
Site sub-div:	Grave fills:	EMPTY
Plan no: 7	Grave cut:	Finds None
Section no:	Skeleton: NONE	Breastplate Grip
Co-ordinates:	Matrix location: in vault 012	Hinge Bracket
Levels	Preservation: POOR	Fixing nails Shroud pins
Slide No.	Neg No:	Fabric Other finds

Description disturbed & redeposited infants coffin (pb.) w/ traces of wooden inner case. upside down w/ top 'top' opened - bodily vandalised

Discussion

Shape, dimensions and distinguishing characteristics

LID

2 Fe nails - head on inner surface
Lead fold seam - not soldered
p.b dep plate on bottom

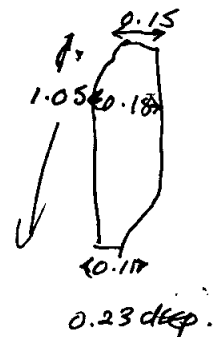

HEAD

"~~Henry~~"
"Mort" Henry Budd
Died 27th July 1814
Aged 4 Years
" " " " "

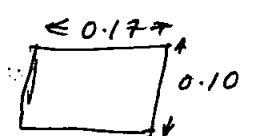

BASE

Recorder:	Date:	Initials:
-----------	-------	-----------

db

SITE 02L00	COFFIN RECORD SHEET	CONTEXT NO. 302
Trench: crypt	Additional sheets:	Treatment: INTACT
Site sub-div:	Grave fills	
Plan no: 7	Grave cut:	Finds None
Section no:	Skeleton:	Breastplate Grip
Co-ordinates:	Matrix location: in vault 012	Hinge Bracket
Levels	Preservation:	Fixing nails Shroud pins
Slide No.	Neg No:	Fabric Other finds

Description

Discussion

Shape, dimensions and distinguishing characteristics

LID

HEAD

BASE

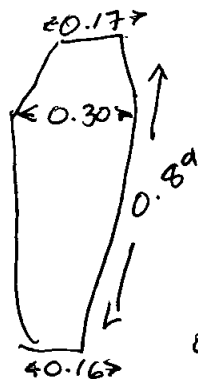

no dep. plate.
no such. inscription

63 ← detail repeated stamped design to form bordered decoration p.b. coffin - inscription straight on also. i.e. no dep. plate no such. - diff undertaking.

" Miss Emma Sawyer
Died Nov^r 22nd 1817
Aged 17 Mon^{ths} "

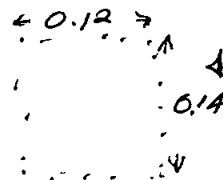

Recorder:

Date:

Initials:

db

SITE	COFFIN RECORD SHEET	CONTEXT NO.
04200		303
Trench: CRYPT	Additional sheets: YES x 2.	Treatment: Skeleton lifted - no DNA possible.
Site sub-div:	Grave fills	
Plan no: 7	Grave cut:	Finds None
Section no:	Skeleton:	Breastplate Grip ✓
Co-ordinates:	Matrix location: in vault 012	Hinge Bracket
Levels	Preservation:	Fixing nails Shroud pins
Slide No.	Neg No:	Fabric Other finds

Description p.b. coffin v. badly vandalised - top ripped open, interior waterlogged - con of 'Budweiser' beer & burnt-down candle on lid & newspaper. (modern).
+ 3 x grips.

Discussion

Shape, dimensions and distinguishing characteristics

LID



p. hole plate

"Mrs Re... coo
Sow.ber
Died 5th December
1853
Aged 74 Years"

HEAD

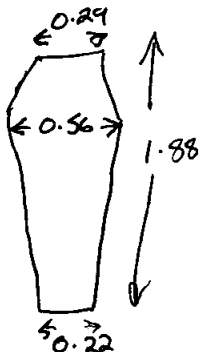

0.38 deep

BASE

Recorder:

Date:

Initials:

Site Code

Context

OLR00

303

Outer Coffin

Sample Ret.

Recording Date 21/9/00

Associated Numbers

Condition FAIR

Dep. Plate

Legible

Inscription see previous sheet. no match for sptfcls. 'sunburst' in top RHS corner & zigzag border visible, see sketch for detail.

Fabric lead ormolou brass tin plated pewter gilt tin
 iron silvered tin enamelled other Sample Ret.

Shape of dep. plate

square rectangle shield tapered lozenge
 cartouche oval other

Upholstery

colour shoddy velvet other BAIZE Sample Ret.

Construction

butt joint mitred pitched other

Grip plate ^{ROSETTES} Fabric = ormolou brass tin plated pewter gilt tin
 iron ^{x 2 + 1 x frog.} silvered tin enamelled other Sample Ret.

Grip Fabric = ormolou brass iron Sample Ret.

Design

swag of rose horseshoe cherub's head plain

other dec. grip w/ rosette @ each terminal between bolt & wood. no match for sptfcls.

Grip bolts **Corner bolts** **Type =** gilt brass brass iron

other Sample Ret.

Lid motifs other Sample Ret.

Escutcheons other Sample Ret.

Upholstery nails brass gilt brass silvered brass iron enamelled
 other Sample Ret.

Fixings panel nails screws hinges lace Sample Ret.

Timber type Sample Ret.

Interpretation / Comments

.....

db

SITE OLR00	COFFIN RECORD SHEET	CONTEXT NO. 304
Trench: CRYPT	Additional sheets:	Treatment: Skeleton Lifted - DNA taken
Site sub-div:	Grave fills	
Plan no: 7	Grave cut:	Finds None
Section no:	Skeleton:	Breastplate Grip ✓
Co-ordinates:	Matrix location: in Vault 12	Hinge Bracket up studs Fixing nails ✓
Levels	Preservation:	Shroud pins
Slide No.	Neg No:	Fabric Other finds

Description p.b. coffin vandalized & top ripped ~~off~~ open. Studwork keels. head missing

Discussion

Shape, dimensions and distinguishing characteristics

LID

HEAD

BASE

p.b. dep. ~~plate~~ " inscription. " Mrs
 (V-chiseled) Joseph Stockall
 with some stamped Died Jan⁴ 23rd 1821
 border as 302 8Ath Year"

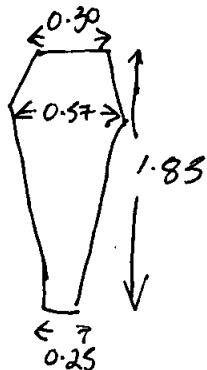

Recorder:	Date:	Initials:
-----------	-------	-----------

db

SITE OLR00	COFFIN RECORD SHEET	CONTEXT NO. 305
Trench: CRYPT	Additional sheets: YES x1	Treatment: skeleton lifted
Site sub-div:	Grave fills	- NO DNA -
Plan no: 7	Grave cut:	Finds None
Section no:	Skeleton:	Breastplate Grip
Co-ordinates:	Matrix location: in vault 15	Hinge Bracket
Levels	Preservation: POOR	Fixing nails Shroud pins
Slide No.	Neg No:	Fabric Other finds

Description
p.b. coffin - no dep plate - destroyed/vandalised - no name

Discussion

Shape, dimensions and distinguishing characteristics

LID

HEAD

BASE

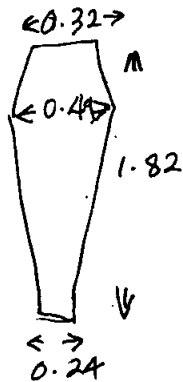

GA
0.38 deep

Recorder:	Date:	Initials:
-----------	-------	-----------

Coffin Recording Sheet

Site Code

Context

Outer Coffin

Sample Ret.

04200

305

Recording Date 19/10

Associated Numbers

Condition

Dep. Plate

Legible

Inscription

Fabric lead ormolou brass tin plated pewter gilt tin
 iron silvered tin enamelled other Sample Ret.

Shape of dep. plate

square rectangle shield tapered lozenge
 cartouche oval other

Upholstery

colour shoddy velvet other Sample Ret.

Construction

butt joint mitred pitched other

Grip plate Fabric = ormolou brass tin plated pewter gilt tin
 iron silvered tin enamelled other *p.b. x 3 (31)'s* Sample Ret.
Block

Grip Fabric = ormolou brass iron *x 3 (1)'s* Sample Ret.

Design swag of rose horseshoe cherub's head plain
 other

Grip bolts Corner bolts Type = gilt brass brass iron
 other Sample Ret.

Lid motifs other Sample Ret.

Escutcheons other Sample Ret.

Upholstery ^{*studs*} ~~nails~~ brass gilt brass silvered brass iron *x 1 piece* enamelled
 other *strip of A attached to LHS of grip plate* Sample Ret.

Fixings panel nails screws hinges lace Sample Ret.

Timber type Sample Ret.

Interpretation / Comments

.....

db

SITE OLR00	COFFIN RECORD SHEET	CONTEXT NO. 306
Trench: CRYPT	Additional sheets:	Treatment: NOT OPENED NO SAMPLES
Site sub-div:	Grave fills	
Plan no: 7	Grave cut:	Finds None
Section no:	Skeleton:	Breastplate Grip
Co-ordinates:	Matrix location: IN VAULT 15	Hinge Bracket
Levels	Preservation: INTACT	Fixing nails Shroud pins
Slide No.	Neg No:	Fabric Other finds :

Description
infant p.b. coffin. intact -

Discussion

Shape, dimensions and distinguishing characteristics

LID

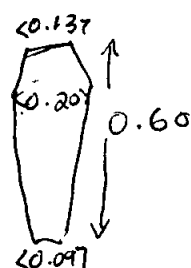

0.15 deep.

HEAD

BASE

Recorder:	Date:	Initials:
-----------	-------	-----------

db

SITE	COFFIN RECORD SHEET	CONTEXT NO.
0LR00		307
Trench: CRYPT	Additional sheets: YES x 3	Treatment: DNA samples taken & skull removed
Site sub-div:	Grave fills	
Plan no: 7	Grave cut:	Finds: None Inscription Breastplate + plates x 2 Grip ✓ + plates ✓
Section no:	Skeleton:	
Co-ordinates:	Matrix location: IN VAULT 15.	Hinge Bracket
Levels	Preservation: POOR OUTSIDE GOOD INSIDE FOR TEXTILES - SKULLY FAIR	Fixing nails Shroud pins
Slide No.	Neg No:	Fabric ✓ Other finds

Description Interior - pillow @ head end; poss. horse hair filling - thin cheap cotton/linen w/ brian underneath. Wooden inner case preserved & 6x keel cuts visible. 1" thick wood w/ v. thin plain ^{silks} lining surviving @ head in nec panel. Mattress - silk? w/ ~~wool~~ horse - kapok? stuffing

Discussion

Shape, dimensions and distinguishing characteristics

pb. dep. inscription on p-b coffin

LID

" Thomas Hughes
Esq "

Died 30 June
1831

In his 59th year "

HEAD

BASE



0.37 deep.

Recorder:

Date:

Initials:

Site Code

Context

OLR00

307

Outer Coffin

Sample Ret.

Recording Date 21/9/00

Associated Numbers

Condition poor 1

Dep. ~~Plate~~ ^{inscription}

Legible

Inscription

+ 2 x plates.
~~SKA inscription sheet = inscription directly on the coffin, no plate or sects.~~

Fabric lead (x3) ormolou brass tin plated pewter gilt tin
iron silvered tin enamelled other Sample Ret.

Shape of dep. plate

square ^{small} rectangle shield tapered 1 ⁽⁸⁴⁾ lozenge
cartouche oval other NA ^{inscip x1} black.

Upholstery

colour shoddy velvet other Sample Ret.

Construction

butt joint mitred pitched other

Grip plate

^{x2} Fabric = ormolou brass tin plated pewter x1 gilt tin
iron silvered tin x1 enamelled ^{Block - both} other Sample Ret.

Grip

Fabric = ormolou brass iron x3 Sample Ret.

Design

swag of rose horseshoe cherub's head ^(4s) plain
other

Grip bolts

Corner bolts Type = gilt brass brass iron

other Sample Ret.

Lid motifs

other Sample Ret.

Escutcheons

other Sample Ret.

Upholstery nails

brass gilt brass silvered brass iron enamelled
other Sample Ret.

Fixings

panel nails screws hinges lace Sample Ret.

Timber type

Sample Ret.

Interpretation / Comments

.....
.....

a) = pewter; tin dipped.

AR00

307

grip plate

a) - almost complete except grip is missing. Fixed w/ small Fe screws/nails. Block enamelled obverse. measures 0.23 x 0.16 m. ~~Similar to~~ (Sptfdo 31) see below.

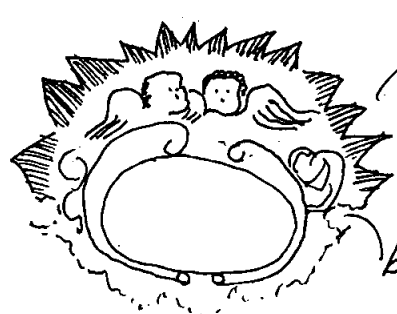

'sun rays' instead of husk flower goeland border.

bolt hole for grip

b) = silvered tin.

grip plate

b) - poorer condition & also grip missing but bolt-holes & Fe. skining on obverse show where it was. Velvet still sticking to reverse. different fabric & design from grip plate a) - perhaps mixed set for head & foot / side panels? Block enamelled obverse. Velvet is double thickness round remaining Fe. fixing pin. measures 0.21 x 0.13 m. 'Kidney' shaped cartouche. Similar to Sptfdo 6, but no winged cherubs head, with rococo type design round cartouche. (no match)

see next page for proper sketch.

1 x badly conc. grip

plate (b)
Sptfdo 84

"Thomas Hughes
Esq"

Died 30th June

1831

In his 59th year

plate (a)
(foot plate?)

"Tho^s Hughes

Esq^r

1831

In his 59th year

ORROO

307
cont

(~~part~~ spiffels 31)

307a

black enamelled
silvered tin

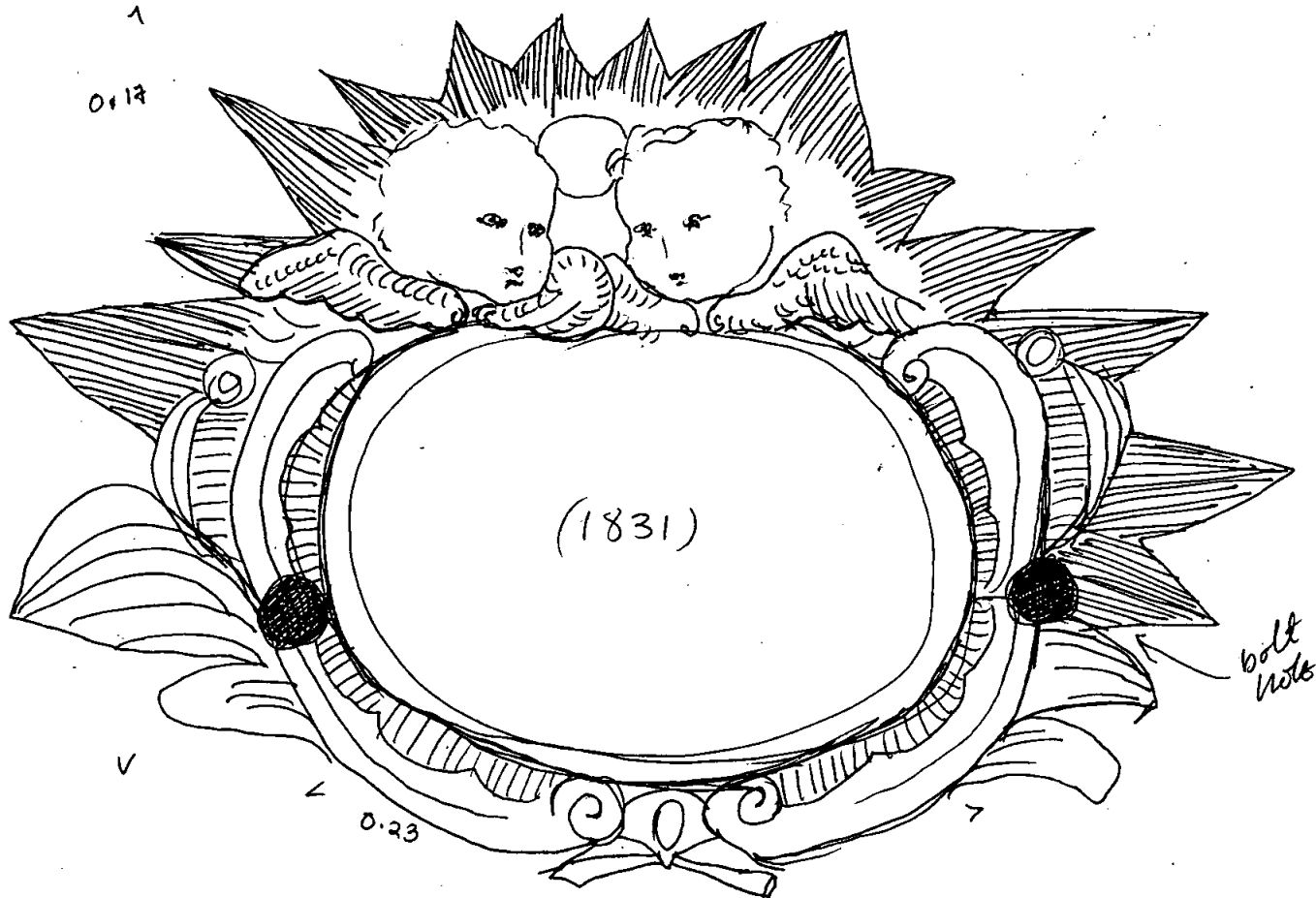

307b.

black enamelled
tin pewter



poss.

307 a = side panel
grips

307 b = head or foot
panel grips

?

dh

SITE OLR00	COFFIN RECORD SHEET	CONTEXT NO. 308
Trench: C0MPT	Additional sheets:	Treatment: INTACT no samples taken
Site sub-div:	Grave fills:	
Plan no: 7	Grave cut:	Finds None
Section no:	Skeleton:	Breastplate Grip
Co-ordinates:	Matrix location: in vault 15. under 306	Hinge Bracket
Levels:	Preservation: INTACT	Fixing nails Shroud pins
Slide No.:	Neg No.:	Fabric Other finds

Description
 intact p.b. coffin - dep. inscription illegible due to lead oxidation, but stamped (directly onto lid) border just visible.

Discussion

Shape, dimensions and distinguishing characteristics

LID

HEAD

BASE

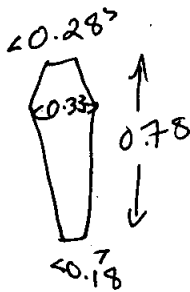

deep = 0.28

Recorder:	Date:	Initials:
-----------	-------	-----------

db.

SITE OLR00		COFFIN RECORD SHEET		CONTEXT NO. 309	
Trench:		Additional sheets: -		Treatment: Bones collected	
Site sub-div: CRYPT		Grave fills			
Plan no: 7		Grave cut:		Finds None	
Section no:		Skeleton: 309		Breastplate Grip	
Co-ordinates:		Matrix location: Bay 3.		Hinge Bracket	
Levels		Preservation: cut open lead coffin foot.		Fixing nails Shroud pins	
Slide No.		Neg No:		Fabric Other finds	
<p>Description vandalised / displaced lead coffin. Size! - length 0.86m Head, 0.16m foot 0.09m Shoulder, 0.26m depth. 0.23m</p> <p>Discussion lead nailed at head end, no plate or inscription, interior wood coffin (plain) partly preserved. Bones disturbed but sig. amount collected. coffin - cut open / partly crushed.</p>					
<p>Shape, dimensions and distinguishing characteristics</p> <p>lead coffin burial - displaced & vandalised but bones still present.</p>					
LID					
HEAD					
BASE					
Recorder: DS		Date: 21/9/00		Initials:	

db.

SITE		COFFIN RECORD SHEET		CONTEXT NO.	
OLR00				310	
Trench:		Additional sheets:		Treatment: Bones collected.	
Site sub-div: cxypt		Grave fills			
Plan no: 7		Grave cut:		Finds	
				None	
Section no:		Skeleton: 310		Breastplate	
				Grip	
Co-ordinates:		Matrix location: Bag 3.		Hinge	
				Bracket	
Levels		Preservation: cut open lead coffin, roof.		Fixing nails	
				Shroud pins	
Slide No.:		Neg No:		Fabric	
				Other finds:	
<p>Description Vandalised / crushed lead coffin Size: length 1.10m x shoulder c. 0.20m inner wood coffin - frags remain. Some bone collected.</p> <p>Discussion Displaced from original position. Lead nailed in at least 2 places on the seams. no plate or inscription.</p>					
<p>Shape, dimensions and distinguishing characteristics</p> <p>Vandalised lead coffin burial - bones collected.</p>					
LID					
HEAD					
BASE					
Recorder: DS		Date: 21/9		Initials:	

110.

SITE <u>OLR00</u>		COFFIN RECORD SHEET		CONTEXT NO. 311 <u>311</u>	
Trench:		Additional sheets:		Treatment: <u>NO bones collected.</u>	
Site sub-div: <u>CRYPT</u>		Grave fills			
Plan no: <u>7</u>		Grave cut:		Finds None	
Section no:		Skeleton: <u>NO.</u>		Breastplate Grip	
Co-ordinates:		Matrix location: <u>bag 3.</u>		Hinge Bracket	
Levels		Preservation: <u>crushed/opened lead coffin - only frags of bone present. V. poor</u>		Fixing nails Shroud pins	
Slide No.		Neg No:		Fabric Other finds	
<p>Description <u>lead coffin - lid completely removed but present (had torn along seams) no wood coffin seen. frags of cranium / vertebrae but not kept.</u></p> <p>Discussion <u>- displaced / vandalised. - no plate or inscription etc. Size:- 0.70 x C.O. 20.</u></p>					
<p>Shape, dimensions and distinguishing characteristics</p> <p><u>vandalised lead coffin - bones not not kept as only frags.</u></p>					
LID					
HEAD					
BASE					
Recorder: <u>DS</u>		Date: <u>2/9/00</u>		Initials:	

db

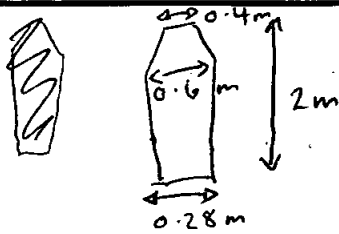
SITE		COFFIN RECORD SHEET		CONTEXT NO.	
OLR 00				312	
Trench:		Additional sheets: YES x 1		Treatment: Bones collected.	
Site sub-div: NC		Grave fills: -			
Plan no: 3		Grave cut: -		Finds: None	
Section no:		Skeleton: 312		Breastplate: Grip	
Co-ordinates:		Matrix location: o/lies 316 u/lies 298		Hinge: Bracket	
Levels:		Preservation: Good.		Fixing nails: Shroud pins	
Slide No.:		Neg No.:		Fabric: Other finds:	
<p>Description: E-W. Lead Coffin, Disturbed by later burials on top, lid collapsed etc.</p>  <p>Depth of coffin - 0.5m.</p>					
Discussion					
Shape, dimensions and distinguishing characteristics					
LID					
HEAD					
BASE					
Recorder: D. Hall		Date: 25.9.00		Initials: DA	

Coffin Recording Sheet

Outer Coffin

Sample Ret.

Site Code

Context

OLR00

312

Recording Date 19/10

Associated Numbers

Condition 1

Dep. Plate

Legible

Inscription

ILLEGIBLE

Fabric lead ormolou brass tin plated pewter gilt tin
 iron silvered tin enamelled other Sample Ret.

Shape of dep. plate

square rectangle shield tapered lozenge
 cartouche oval other

Upholstery

colour shoddy velvet other Sample Ret.

Construction

butt joint mitred pitched other

Grip plate Fabric = ormolou brass tin plated pewter gilt tin
 iron silvered tin enamelled other Sample Ret.

Grip Fabric = ormolou brass iron Sample Ret.

Design swag of rose horseshoe cherub's head plain
 other

Grip bolts **Corner bolts** Type = gilt brass brass iron
 other Sample Ret.

Lid motifs other Sample Ret.

Escutcheons other Sample Ret.

Upholstery nails brass gilt brass silvered brass iron enamelled
 other Sample Ret.

Fixings panel nails screws hinges lace Sample Ret.

Timber type Sample Ret.

Interpretation / Comments

.....

db

SITE	0 LR 50	COFFIN RECORD SHEET	CONTEXT NO.	313(b)	
Trench:		Additional sheets:	YES x 1	Treatment:	Bones collected.
Site sub-div:	NC	Grave fills	-	Finds	None
Plan no:	3	Grave cut:	-	Breastplate	Grip
Section no:		Skeleton:	313	Hinge	Bracket
Co-ordinates:		Matrix location:	a/lies 314 WITH 1316	Fixing nails	Shroud pins
Levels		Preservation:	Good.	Fabric	Other finds
Slide No.		Neg No:			

Description E-W. wooden coffin. with studs in lining.
 EXTRA BODY ASSIGNED NO. 3136 SO 313a-15
 Discussion Now 1315 (NOT NOTED SO DONT KNOW WHAT'S GOING ON)
 JH

Shape, dimensions and distinguishing characteristics

LID

HEAD

BASE

Recorder:	D. Hall	Date:	25.9.00	Initials:	DA
-----------	---------	-------	---------	-----------	----

Coffin Recording Sheet

Site Code

Context

0200

313

Outer Coffin

Sample Ret.

Recording Date 29/9/00

Associated Numbers

Condition

Dep. Plate

Legible

Inscription

Fabric lead ormolou brass tin plated pewter gilt tin
 iron silvered tin enamelled other Sample Ret.

Shape of dep. plate

square rectangle shield tapered lozenge
 cartouche oval other

Upholstery

colour shoddy velvet other BAIZE Sample Ret.

Construction butt joint mitred pitched other

Grip plate Fabric = ormolou brass tin plated pewter gilt tin
fasts on rev. of grip - untd
 iron silvered tin enamelled other Sample Ret.

Grip Fabric = ormolou brass iron x2 Sample Ret.

Design swag of rose horseshoe cherub's head plain
 other SAME as 0200 228a, conc.

Grip bolts **Corner bolts** **Type =** gilt brass brass iron
 other Sample Ret.

Lid motifs other Sample Ret.

Escutcheons other Sample Ret.

Upholstery ^{studs} nails brass gilt brass silvered brass iron black enamelled
 other 19 studs in total - 1 piece could be split into 3/4/5/7/11 etc. Sample Ret.

Fixings panel nails screws hinges lace Sample Ret.

Timber type Sample Ret.

Interpretation / Comments

.....

db.

SITE OLR 50		COFFIN RECORD SHEET		CONTEXT NO. 314	
Trench:		Additional sheets:		Treatment: Bones collected	
Site sub-div: NZ		Grave fills: -			
Plan no: 3		Grave cut: -		Finds None	
Section no:		Skeleton: 314		Breastplate Grip	
Co-ordinates:		Matrix location: u/wes 313		Hinge Bracket	
Levels:		Preservation: Good		Fixing nails Shroud pins	
Slide No.:		Neg No.:		Fabric Other finds	

Description **E-W. wooden coffin, studs in lining.**

Discussion

Shape, dimensions and distinguishing characteristics

LID

HEAD

BASE

Recorder: **D. Hall**

Date: **25.9.**

Initials: **DH**

Site Code

Context

Outer Coffin

Sample Ret.

OHRCO

314

Recording Date 22/9/00

Associated Numbers

Condition

Dep. Plate

Legible

Inscription

Fabric lead ormolou brass tin plated pewter gilt tin
 iron silvered tin enamelled other Sample Ret.

Shape of dep. plate

square rectangle shield tapered lozenge
 cartouche oval other

Upholstery

colour shoddy velvet other BAZZE Sample Ret.

Construction butt joint mitred pitched other

Grip plate Fabric = ormolou brass tin plated pewter gilt tin
 iron silvered tin enamelled other Sample Ret.

Press on rev. of grip-unid.

Grip Fabric = ormolou brass iron x1 Sample Ret.

Design swag of rose horseshoe cherub's head plain

other poss. type 3b (5 pths)

Grip bolts **Corner bolts** **Type =** gilt brass brass iron

other Sample Ret.

Lid motifs other Sample Ret.

Escutcheons other Sample Ret.

Upholstery *shudo* nails brass x1 *PELLS* gilt brass silvered brass iron enamelled

other Sample Ret.

Fixings panel nails screws hinges lace Sample Ret.

Timber type Sample Ret.

Interpretation / Comments

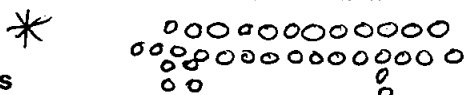

SITE	COFFIN RECORD SHEET	CONTEXT NO.
OLR 00		315
Trench:	Additional sheets:	Treatment: Bones collected.
Site sub-div: NC	Grave fills —	
Plan no: 3	Grave cut: —	Finds
Section no:	Skeleton: 315	None
Co-ordinates:	Matrix location: None.	Breastplate
Levels:	Preservation: Poor.	Grip
Slide No.:	Neg No:	Hinge
Description		Bracket
Articulated skull + Jaw - rest truncated away.		Fixing nails
Discussion		Shroud pins
Shape, dimensions and distinguishing characteristics		Fabric
LID		Other finds
HEAD		:
BASE		
Recorder: D Hall	Date: 25.9.	Initials: DH

Ab.

SITE OLR 00		COFFIN RECORD SHEET		CONTEXT NO. 316	
Trench:		Additional sheets: YES x 1		Treatment: bones collected.	
Site sub-div: NZ		Grave fills —			
Plan no: 3		Grave cut: —		Finds	
Section no:		Skeleton: 316		None	
Co-ordinates:		Matrix location: u/kes 312.		Breastplate	
Levels		Preservation: Good.		Grip	
Slide No.		Neg No:		Hinge	
				Bracket	
				Fixing nails	
				Shroud pins	
				Fabric	
				Other finds	
Description E-W coffin, handles retrieved, good collection rate.					
Discussion					
Shape, dimensions and distinguishing characteristics					
LID					
HEAD					
BASE					
Recorder:		Date:		Initials:	

298
312
316

Site Code

Context

Outer Coffin

Sample Ret.

OR00

316

Recording Date 26/9/00

Associated Numbers

Condition

Dep. Plate

Legible

Inscription

Fabric lead ormolou brass tin plated pewter gilt tin
 iron silvered tin enamelled other Sample Ret.

Shape of dep. plate

square rectangle shield tapered lozenge
 cartouche oval other

Upholstery

colour shoddy velvet other Sample Ret.

Construction

butt joint mitred pitched other

Grip plate Fabric = ormolou brass tin plated pewter gilt tin
FRAYS ON REV. OF GRIPS. iron silvered tin enamelled other Sample Ret.

Grip Fabric = ormolou brass iron 5
one of which is poss. + Sample Ret.

Design swag of rose horseshoe cherub's head plain
 other *v. conc. - poss 4x ① & 1x ④ - plain on side panels w/ 'fancy' head & foot?*

Grip bolts Corner bolts Type = gilt brass brass iron

other Sample Ret.

Lid motifs other Sample Ret.

Escutcheons other Sample Ret.

Upholstery *sheds* nails brass gilt brass silvered brass iron 2 pieces enamelled
 other *8 in total 0000 + 800* Sample Ret.

Fixings panel nails screws hinges lace Sample Ret.

Timber type Sample Ret.

Interpretation / Comments

.....

SITE		COFFIN RECORD SHEET		CONTEXT NO.	
OLR 00				317	
Trench:		Additional sheets:		Treatment: bones collected.	
Site sub-div: NC		Grave fills: —			
Plan no: 3		Grave cut: —		Finds	
				None	
Section no:		Skeleton: 317		Breastplate	
				Grip	
Co-ordinates:		Matrix location: NONE.		Hinge	
				Bracket	
Levels:		Preservation: POOR.		Fixing nails	
				Shroud pins	
Slide No.:		Neg No.:		Fabric	
				Other finds:	
<p>Description HEAVILY truncated by vault, only 1 Tib, 2 Fib + feet remaining.</p> <p>Discussion</p>					
<p>Shape, dimensions and distinguishing characteristics</p> <p>LID</p> <p>HEAD</p> <p>BASE</p>					
Recorder: D. Hall		Date: 25.9.00		Initials: DH	

db-

SITE OLR 00		COFFIN RECORD SHEET		CONTEXT NO. 318	
Trench:		Additional sheets: UES X1		Treatment: Bones collected	
Site sub-div: NC		Grave fills -			
Plan no: 3		Grave cut: -		Finds None	
Section no:		Skeleton: 318		Breastplate Grip	
Co-ordinates:		Matrix location: o/lies 368		Hinge Bracket	
Levels		Preservation: Good.		Fixing nails Shroud pins	
Slide No.		Neg No:		Fabric Other finds	
Description E-W. Directly overlying 368, possibly some mixing with 368.					
Discussion					
Shape, dimensions and distinguishing characteristics					
LID TWO OSTEO. RECORDS					
HEAD AS 318. 566					
BASE ALSO 1318.					
Recorder: D. Hall		Date: 25.9.00		Initials:	

Coffin Recording Sheet

Outer Coffin

Sample Ret.

Site Code

Context

Recording Date 6/12/00

02200

318
318

Associated Numbers

Condition

Dep. Plate

Legible

Inscription

Fabric lead ormolou brass tin plated pewter gilt tin
 iron silvered tin enamelled other Sample Ret.

Shape of dep. plate

square rectangle shield tapered lozenge
 cartouche oval other

Upholstery

colour shoddy velvet other Sample Ret.

Construction

butt joint mitred pitched other

Grip plate

Fabric = ormolou brass tin plated pewter gilt tin
fraggs on REV of grip - unid.
 iron silvered tin enamelled other Sample Ret.

Grip

Fabric = ormolou brass iron *x2* Sample Ret.

Design

swag of rose horseshoe cherub's head plain

other *too conc. to id.*

Grip bolts

Corner bolts Type = gilt brass brass iron

other Sample Ret.

Lid motifs

other Sample Ret.

Escutcheons

other Sample Ret.

Upholstery

stud
 nails brass gilt brass silvered brass iron enamelled

other *1 x stud* Sample Ret.

Fixings

panel nails screws hinges lace Sample Ret.

Timber type

Sample Ret.

Interpretation / Comments

.....

db.

SITE OLR 00	COFFIN RECORD SHEET	CONTEXT NO. 319
Trench:	Additional sheets: 4E5x1	Treatment: Bones collected.
Site sub-div: NC	Grave fills	
Plan no: 3	Grave cut:	Finds None
Section no:	Skeleton: 319	Breastplate Grip
Co-ordinates:	Matrix location: under 366 over 367.	Hinge Bracket
Levels	Preservation:	Fixing nails Shroud pins
Slide No.	Neg No:	Fabric Other finds:
Description <p>('V' close together with 366/367 - difficult to identify spec' coffins of each sep' burial.)</p>		
Discussion		
Shape, dimensions and distinguishing characteristics <p>319 mixed with 367 & 366 sacrum from 367 Left radius 1 lumbar 5 lumbar - poss SE 367</p>		
LID		
HEAD		
BASE		
Recorder: DS	Date: 25/9	Initials:

Coffin Recording Sheet

Site Code

Context

02/00

314
~~12~~

Outer Coffin

Sample Ret.

Recording Date 5/12/00

Associated Numbers

Condition

Dep. Plate

Legible

Inscription

Fabric lead ormolou brass tin plated pewter gilt tin
 iron silvered tin enamelled other Sample Ret.

Shape of dep. plate

square rectangle shield tapered lozenge
 cartouche oval other

Upholstery

colour shoddy velvet other Sample Ret.

Construction

butt joint mitred pitched other

Grip plate Fabric = ormolou brass tin plated pewter gilt tin
 iron *Feas on rev of grip-unid.* silvered tin enamelled other Sample Ret.

Grip Fabric = ormolou brass iron *conc. (A)* Sample Ret.

Design swag of rose horseshoe cherub's head plain
 other

Grip bolts Corner bolts Type = gilt brass brass iron

other Sample Ret.

Lid motifs other Sample Ret.

Escutcheons other Sample Ret.

Upholstery nails brass gilt brass silvered brass iron enamelled
 other Sample Ret.

Fixings panel nails screws hinges lace Sample Ret.

Timber type Sample Ret.

Interpretation / Comments

.....

SITE OLR 00		COFFIN RECORD SHEET		CONTEXT NO. 320	
Trench:		Additional sheets:		Treatment: <i>Bones collected.</i>	
Site sub-div: NC		Grave fills: -			
Plan no: 3		Grave cut: -		Finds	
Section no:		Skeleton: 320		None	
Co-ordinates:		Matrix location: o/les 321		Breastplate	
Levels		Preservation: Fair. <i>Skull, part spine + both humeri at 22.9.</i>		Grip	
Slide No.		Neg No:		Hinge	
Description		E-W. Close proximity to 321 + 322 -		Bracket	
Discussion				Fixing nails	
Shape, dimensions and distinguishing characteristics				Shroud pins	
LID				Fabric	
HEAD				Other finds	
BASE					
Recorder: D Hall		Date: 25.9.00		Initials: DH	

110

SITE OLR 00		COFFIN RECORD SHEET		CONTEXT NO. 321	
Trench:		Additional sheets: YES x 1		Treatment: Bones collected.	
Site sub-div: NC		Grave fills: —			
Plan no: 3		Grave cut: —		Finds None	
Section no:		Skeleton: 321		Breastplate Grip	
Co-ordinates:		Matrix location: o/wes 320, o/wes 322		Hinge Bracket	
Levels:		Preservation: Fair/good - skull, part spine + humeri at 22.9.00		Fixing nails Shroud pins	
Slide No.:		Neg No:		Fabric Other finds	
Description E-U, wood coffin, rest to be collected later.					
Discussion					
Shape, dimensions and distinguishing characteristics					
LID					
HEAD					
BASE					
Recorder: D Harker		Date: 25.9.		Initials: DH	

Coffin Recording Sheet

Outer Coffin

Sample Ret.

Site Code

OLR00

Context

321

Recording Date

Associated Numbers

Condition

Dep. Plate

Legible

Inscription

Fabric lead ormolou brass tin plated pewter gilt tin
 iron silvered tin enamelled other Sample Ret.

Shape of dep. plate

square rectangle shield tapered lozenge
 cartouche oval other

Upholstery

colour shoddy velvet other Sample Ret.

Construction

butt joint mitred pitched other

Grip plate Fabric = ormolou brass tin plated pewter gilt tin
 iron silvered tin enamelled other Sample Ret.

Grip Fabric = ormolou brass iron *x 1 v. badly conc. - unid.* Sample Ret.

Design swag of rose horseshoe cherub's head plain

other

Grip bolts **Corner bolts** **Type =** gilt brass brass iron

other Sample Ret.

Lid motifs other Sample Ret.

Escutcheons other Sample Ret.

Upholstery ^{studs} nails brass gilt brass silvered brass iron *2' piece* enamelled

other *∞ 2x studs* Sample Ret.

Fixings panel nails screws hinges lace Sample Ret.

Timber type Sample Ret.

Interpretation / Comments

.....

db.

SITE		COFFIN RECORD SHEET		CONTEXT NO.	
OLR 00				322	
Trench:		Additional sheets: YES x 1		Treatment: Bones collected.	
Site sub-div: NC		Grave fills /			
Plan no: 3		Grave cut: /		Finds	
Section no:		Skeleton: 322		None	
Co-ordinates:		Matrix location: U/Les 321		Breastplate	
Levels		Preservation: Good - partial collection at 22.9.00.		Grip	
Slide No.		Neg No:		Hinge	
Description E-W				Bracket	
Discussion				Fixing nails	
Shape, dimensions and distinguishing characteristics				Shroud pins	
LID				Fabric	
HEAD				Other finds	
BASE					
Recorder: O Hall		Date: 25.9.		Initials: OH	

Coffin Recording Sheet

Site Code

Context

OLR00

322

Outer Coffin

Sample Ret.

Recording Date 18/10

Associated Numbers

Condition

Dep. Plate

Legible

Inscription

Fabric lead ormolou brass tin plated pewter gilt tin
 iron silvered tin enamelled other Sample Ret.

Shape of dep. plate

square rectangle shield tapered lozenge
 cartouche oval other

Upholstery

colour shoddy velvet other Sample Ret.

Construction

butt joint mitred pitched other

Grip plate Fabric = ormolou brass tin plated pewter gilt tin
 iron silvered tin enamelled other Sample Ret.

Grip Fabric = ormolou brass iron ^{x1} Sample Ret.

Design swag of rose horseshoe cherub's head plain
 other *1 x spHds ①*

Grip bolts Corner bolts Type = gilt brass brass iron
 other Sample Ret.

Lid motifs other

Escutcheons other

Upholstery nails brass gilt brass silvered brass iron enamelled
 other Sample Ret.

Fixings panel nails screws hinges lace Sample Ret.

Timber type

Interpretation / Comments

.....

db

SITE OLR 00	COFFIN RECORD SHEET	CONTEXT NO. 323
Trench:	Additional sheets: YES x1	Treatment: Bones collected.
Site sub-div: NC	Grave fills: —	
Plan no: 3	Grave cut: —	Finds None
Section no:	Skeleton: 323	Breastplate Grip
Co-ordinates:	Matrix location: Truncated by 320 + 321	Hinge Bracket
Levels	Preservation: Poor - legs truncated away, bone v. fragile	Fixing nails Shroud pins
Slide No.	Neg No:	Fabric Other finds
Description E-W. wooden coffin, poor bone quality.		
Discussion		
Shape, dimensions and distinguishing characteristics		
LID		
HEAD		
BASE		
Recorder: D. Hall	Date: 25.9.00	Initials: DH

Coffin Recording Sheet

Site Code

Context

OK100

323

Outer Coffin

Sample Ret.

Recording Date 14/10

Associated Numbers

Condition

Dep. Plate

Legible

Inscription

Fabric lead ormolou brass tin plated pewter gilt tin
 iron silvered tin enamelled other Sample Ret.

Shape of dep. plate

square rectangle shield tapered lozenge
 cartouche oval other

Upholstery

colour shoddy velvet other Sample Ret.

Construction

butt joint mitred pitched other

Grip plate Fabric = ormolou brass tin plated pewter gilt tin
 iron silvered tin enamelled other Sample Ret.

FRAGS on rev. of grip.

Grip Fabric = ormolou brass iron Sample Ret.

Design swag of rose horseshoe cherub's head plain
 other *conc. unid.*

Grip bolts Corner bolts Type = gilt brass brass iron
 other Sample Ret.

Lid motifs other Sample Ret.

Escutcheons other Sample Ret.

Upholstery ~~nails~~ studs brass gilt brass silvered brass iron x 5 enamelled
 other *all strips (A)=8 (B)=6 (C)=7 (D)=7 (E)=7 ∴ 35 total studs* *PELLES* Sample Ret.

Fixings panel nails screws hinges lace Sample Ret.

Timber type Sample Ret.

Interpretation / Comments

.....

db

SITE <i>OLR 00</i>		COFFIN RECORD SHEET	CONTEXT NO. <i>324</i>
Trench:	Additional sheets:	Treatment: <i>Bones collected.</i>	
Site sub-div: <i>NC</i>	Grave fills: <i>—</i>		
Plan no: <i>3</i>	Grave cut: <i>—</i>	Finds	
Section no:	Skeleton: <i>324</i>	None	
Co-ordinates:	Matrix location: <i>o/lies 325</i>	Breastplate	
Levels	Preservation: <i>Fair.</i>	Grip	
Slide No.	Neg No:	Hinge	
		Bracket	
		Fixing nails	
		Shroud pins	
		Fabric	
		Other finds	
Description <i>E-W. Spine, humeri + radius, ulna of L arm at 22-9-00.</i>			
Discussion			
Shape, dimensions and distinguishing characteristics			
LID			
HEAD			
BASE			
Recorder: <i>D. Hall</i>	Date: <i>25-9-00</i>	Initials: <i>DH</i>	

db -

SITE OLR 50	COFFIN RECORD SHEET	CONTEXT NO. 325
Trench:	Additional sheets: /	Treatment: <i>Bones collected.</i>
Site sub-div: NZ	Grave fills /	
Plan no: 3	Grave cut: /	Finds None
Section no:	Skeleton: 325	Breastplate Grip
Co-ordinates:	Matrix location: 324 325 326	Hinge Bracket
Levels	Preservation: <i>Good</i>	Fixing nails Shroud pins
Slide No.	Neg No:	Fabric Other finds

Description **JUVENILE. E-W.**

Discussion

Shape, dimensions and distinguishing characteristics

LID

HEAD

BASE

Recorder: <i>D. H. M.</i>	Date: 25-9.	Initials:
---------------------------	--------------------	-----------

SITE <i>OLR 00</i>		COFFIN RECORD SHEET	CONTEXT NO. <i>326</i>
Trench:		Additional sheets:	Treatment: <i>Bones collected.</i>
Site sub-div: <i>NC</i>		Grave fills: <i>/</i>	
Plan no: <i>3</i>		Grave cut: <i>/</i>	Finds None
Section no:		Skeleton: <i>326</i>	Breastplate Grip
Co-ordinates:		Matrix location: <i>325</i> <i>326</i>	Hinge Bracket
Levels		Preservation: <i>Good</i>	Fixing nails Shroud pins
Slide No.		Neg No:	Fabric Other finds
Description <i>E-W - child/teenite.</i>			
Discussion			
Shape, dimensions and distinguishing characteristics			
LID			
HEAD			
BASE			
Recorder: <i>D. Hall</i>	Date: <i>25.9.</i>	Initials:	

db.

SITE	COFFIN RECORD SHEET	CONTEXT NO.
OLR 00	Additional sheets: YES x1	327 Treatment: Bones collected.
Trench:	Grave fills /	
Site sub-div: NC	Grave cut: /	Finds
Plan no: 3	Skeleton: 327	None
Section no:	Matrix location: Truncated by 328 or possibly both trunc. by other feature - appear contemporary.	Breastplate
Co-ordinates:	Preservation: Fair.	Grip
Levels	Neg No:	Hinge
Slide No.	Description	Bracket
Discussion	E-W. Child/Juvenile.	Fixing nails
Shape, dimensions and distinguishing characteristics	Discussion	Shroud pins
LID	Shape, dimensions and distinguishing characteristics	Fabric
HEAD	LID	Other finds
BASE	HEAD	
Recorder: D. Hall	Date: 25-9.	Initials:

Site Code

Context

Outer Coffin

Sample Ret.

OLR00

327

Recording Date 26/9/00

Associated Numbers

Condition

Dep. Plate

Legible

Inscription

Fabric lead ormolou brass tin plated pewter gilt tin
 iron silvered tin enamelled other Sample Ret.

Shape of dep. plate

square rectangle shield tapered lozenge
 cartouche oval other

Upholstery

colour shoddy velvet other Sample Ret.

Construction

butt joint mitred pitched other

Grip plate

tags on lev. of grip
iron

Fabric = ormolou silvered tin brass tin plated pewter gilt tin
 enamelled other Sample Ret.

Grip

Fabric = ormolou brass iron 2 Sample Ret.

Design

swag of rose horseshoe cherub's head plain

other v. badly conc. peop. spit. ①

Grip bolts

Corner bolts Type = gilt brass brass iron

other Sample Ret.

Lid motifs

other Sample Ret.

Escutcheons

other Sample Ret.

Upholstery nails

brass gilt brass silvered brass iron enamelled

other Sample Ret.

Fixings

panel nails screws hinges lace Sample Ret.

Timber type

Sample Ret.

Interpretation / Comments

.....

db

SITE OLR 00		COFFIN RECORD SHEET		CONTEXT NO. 328	
Trench:		Additional sheets:		Treatment: <i>Bones collected.</i>	
Site sub-div: NZ		Grave fills: -			
Plan no: 3		Grave cut: -		Finds None	
Section no:		Skeleton: 328		Breastplate Grip	
Co-ordinates:		Matrix location: <i>poss. truncates 327, possibly contemporary + both truncated by other feature.</i>		Hinge Bracket	
Levels:		Preservation: <i>Fair.</i>		Fixing nails Shroud pins	
Slide No.:		Neg No.:		Fabric Other finds:	
Description E-W.					
Discussion					
Shape, dimensions and distinguishing characteristics					
LID					
HEAD					
BASE					
Recorder: Datum		Date: 25.9.		Initials:	

SITE	COFFIN RECORD SHEET	CONTEXT NO.
OLR 00		329
Trench:	Additional sheets: YESX1.	Treatment: Bones collected.
Site sub-div: NZ	Grave fills /	
Plan no: 3	Grave cut: /	Finds
Section no:	Skeleton: 329	None
Co-ordinates:	Matrix location: Truncates 330	Breastplate
Levels	Preservation: Good.	Grip
Slide No.	Neg No:	Hinge
Description	E-W	Bracket
Discussion		Fixing nails
Shape, dimensions and distinguishing characteristics		Shroud pins
LID		Fabric
HEAD		Other finds
BASE		
Recorder: D. Ham	Date: 25-9.	Initials:

Outer Coffin

Sample Ret.

Site Code

Context

Recording Date 1/12/00

ALCO

329

Associated Numbers

Condition

Dep. Plate

Legible

Inscription

Fabric lead ormolou brass tin plated pewter gilt tin
 iron silvered tin enamelled other Sample Ret.

Shape of dep. plate

square rectangle shield tapered lozenge
 cartouche oval other

Upholstery

colour shoddy velvet other Sample Ret.

Construction

butt joint mitred pitched other

Grip plate

Fabric = ormolou brass tin plated pewter gilt tin
 iron silvered tin enamelled other Sample Ret.
Frogs on rev of grip - unid

Grip

Fabric = ormolou brass iron *α1* Sample Ret.

Design

swag of rose horseshoe cherub's head plain

other 36

Grip bolts

Corner bolts Type = gilt brass brass iron

other Sample Ret.

Lid motifs

other Sample Ret.

Escutcheons

other Sample Ret.

Upholstery nails

brass gilt brass silvered brass iron enamelled

other Sample Ret.

Fixings

panel nails screws hinges lace Sample Ret.

Timber type

Sample Ret.

Interpretation / Comments

.....

SITE <i>OLR 00</i>	COFFIN RECORD SHEET	CONTEXT NO. <i>330</i>
Trench:	Additional sheets:	Treatment: <i>Bones collected.</i>
Site sub-div: <i>NC</i>	Grave fills <i>/</i>	
Plan no: <i>3</i>	Grave cut: <i>/</i>	Finds None
Section no:	Skeleton: <i>330</i>	Breastplate Grip
Co-ordinates:	Matrix location: <i>Truncated by 329</i>	Hinge Bracket
Levels	Preservation: <i>Good</i>	Fixing nails Shroud pins
Slide No.	Neg No:	Fabric Other finds
Description <i>E-W.</i>		
Discussion		
Shape, dimensions and distinguishing characteristics		
LID		
HEAD		
BASE		
Recorder: <i>D. Hum</i>	Date: <i>25-9.</i>	Initials:

SITE <i>OLR 00</i>		COFFIN RECORD SHEET		CONTEXT NO. <i>331</i>	
Trench:		Additional sheets: <i>YES</i>		Treatment: <i>Bones collected.</i>	
Site sub-div: <i>NZ</i>		Grave fills: <i>/</i>			
Plan no: <i>3</i>		Grave cut: <i>/</i>		Finds None	
Section no:		Skeleton: <i>331</i>		Breastplate Grip	
Co-ordinates:		Matrix location:		Hinge Bracket	
Levels:		Preservation: <i>GOOD</i>		Fixing nails Shroud pins	
Slide No.:		Neg No.:		Fabric Other finds	
Description <i>E-W, young adult.</i>					
Discussion					
Shape, dimensions and distinguishing characteristics					
LID					
HEAD					
BASE					
Recorder: <i>D.H.M.</i>		Date: <i>25-9.</i>		Initials:	

Coffin Recording Sheet

Site Code

Context

04200

331

Outer Coffin

Sample Ret.

Recording Date 29/11/00

Associated Numbers

Condition

Dep. Plate

Legible

Inscription

Fabric lead ormolou brass tin plated pewter gilt tin
iron silvered tin enamelled other Sample Ret.

Shape of dep. plate

square rectangle shield tapered lozenge
cartouche oval other

Upholstery

colour shoddy velvet other Sample Ret.

Construction

butt joint mitred pitched other

Grip plate

Fabric = ormolou brass tin plated pewter gilt tin
Flags on REV of grip
iron silvered tin enamelled other Sample Ret.

Grip

Fabric = ormolou brass iron x2 Sample Ret.

Design

swag of rose horseshoe cherub's head *① conc. plain x1*
other *② conc. x 1 small*

Grip bolts

Corner bolts Type = gilt brass brass *↕ 0.04* iron

other Sample Ret.

Lid motifs

other Sample Ret.

Escutcheons

other Sample Ret.

Upholstery

studs
nails brass gilt brass silvered brass iron enamelled
egg
other *9 in total, 1 x piece* Sample Ret.

Fixings

panel nails screws hinges lace Sample Ret.

Timber type

Sample Ret.

Interpretation / Comments

.....
.....

SITE		CONTEXT RECORD		Context No. 332		
OLR00		Additional Sheets:		Type STRUC		
Trench	Context Type: Deposit / Cut / <u>Structure</u>		Check Lists:			
Site sub-div S.C.	Overlain by:		DEPOSIT:			
Structure No.	Abutted by:		1.compaction 2.colour 3.composition 4.inclusions 5.thickness 6.extent 7.comments 8.method & conditions			
Plan No. 4.	Cut by:		CUT:			
Section No. 14.	Filled by:		1.shape in plan 2.base/sides/top profile 3.dimension and depth 4.sketch 5.truncation 6.fill nos 7.other comments			
Co-Ordinates	Same as:		MASONRY:			
Level	Part of:		1.materials 2.size of bricks etc 3.finish of stones 4.coursing/bond 5.form 6.faces 7.bond 8.dimensions as found 9.other comments			
Slide No.	Consists of:					
Neg No.	Overlies:					
Matrix location	Butts:					
	Cuts:					
	Fill of:					
	Relationships uncertain					
Description (See check lists):			STRATIGRAPHIC MATRIX			
<p>Paved pathway running N-S from old st? to SE door of church. - under modern concrete work tarmac</p> <p>↳ to the south also paved path.</p> <p>Slabs :- 1.63 x 0.75 x 0.08m laid across path with edging slabs :- various lengths but c. 0.60m x 0.17 x 0.08m</p> <p>Not bedded on any specific make up - straight into unimproved soil & no mortar</p>						
			<p>Interpretation/Discussion:</p>			
			<p>Finds (tick): None <input type="checkbox"/> Pot <input type="checkbox"/> Bone <input type="checkbox"/> Flint <input type="checkbox"/> Stone <input type="checkbox"/> Burnt stone <input type="checkbox"/> Glass <input type="checkbox"/> Metal <input type="checkbox"/> CBM <input type="checkbox"/> Wood <input type="checkbox"/> Leather <input type="checkbox"/></p>			
			<p>△Small Finds</p>		Recorder DS	
			<p>◇Samples</p>		Date 2/9	
<p>△Building Materials</p>		Initials				

dk

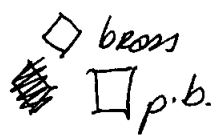
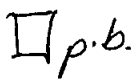
SITE	COFFIN RECORD SHEET	CONTEXT NO.
0L60		333
Trench: CRYPT	Additional sheets:	Treatment: intact - no samples taken
Site sub-div:	Grave fills	
Plan no:	Grave cut:	Finds
		None
Section no:	Skeleton:	Breastplate ✓ x2  brass
		Grip  p.b.
Co-ordinates:	Matrix location: in trough over 335 Box 3 (W)	Hinge
		Bracket
Levels	Preservation:	Fixing nails
		Shroud pins
Slide No.	Neg No:	Fabric
		Other finds:

Description infant p.b. coffin. intact.

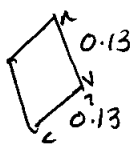

"Miss Hester Stevens
Died 2nd April
1840
Aged 7 weeks
& 3 Days"

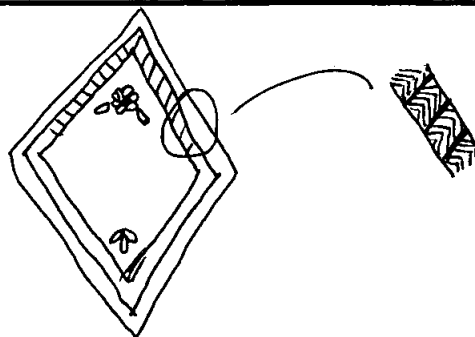

Discussion

Shape, dimensions and distinguishing characteristics

LID

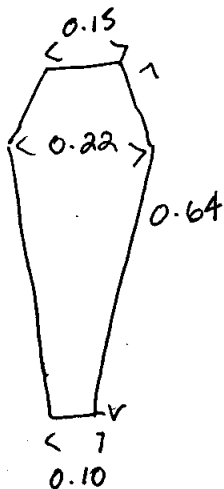

deep = 0.17

"Miss Hester
Stevens
Died 2 April
1840
Aged 7 weeks
& 3 days"

HEAD

BASE

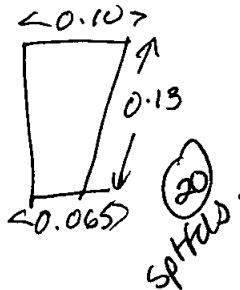

Recorder:

Date:

Initials:

db

SITE OR 200	COFFIN RECORD SHEET	CONTEXT NO. 334
Trench: crypt	Additional sheets:	Treatment: intact - no samples taken.
Site sub-div:	Grave fills	
Plan no: 7	Grave cut:	Finds None
Section no:	Skeleton:	Breastplate <input checked="" type="checkbox"/> <input type="checkbox"/> p.b. Grip
Co-ordinates:	Matrix location: in section 15 box 3 (CW) over 335	Hinge Bracket
Levels	Preservation:	Fixing nails Shroud pins
Slide No.	Neg No:	Fabric Other finds

Description intact p.b. coffin

Discussion

Shape, dimensions and distinguishing characteristics

LID

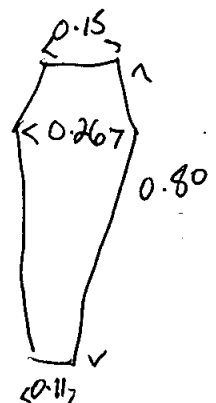

HEAD

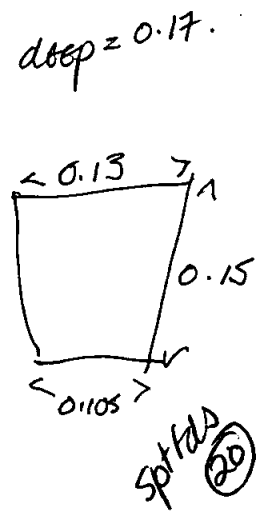

BASE

deep = 0.17.

^a John Muresey
Hunter
Died 5th March
1842
Aged 14 Months^y

spots (20)

Recorder:	Date:	Initials:
-----------	-------	-----------

Ab.

SITE	COFFIN RECORD SHEET	CONTEXT NO.
OL600		335
Trench: CRYPT	Additional sheets:	Treatment: REMOVED GRAVES TAKEN INTACT - NO SAMPLES
Site sub-div:	Grave fills	
Plan no: 7	Grave cut:	Finds TAKEN
Section no:	Skeleton:	Breastplate <input checked="" type="checkbox"/> 2 + mscrp. <input type="checkbox"/> pb - both
Co-ordinates:	Matrix location: in excavation Box 3 under 334 & 333 (W)	Hinge
Levels	Preservation: 4	Bracket
Slide No.	Neg No:	Fixing nails
		Shroud pins
		Fabric
		Other finds

Description: p.b. adult coffin.

Discussion:

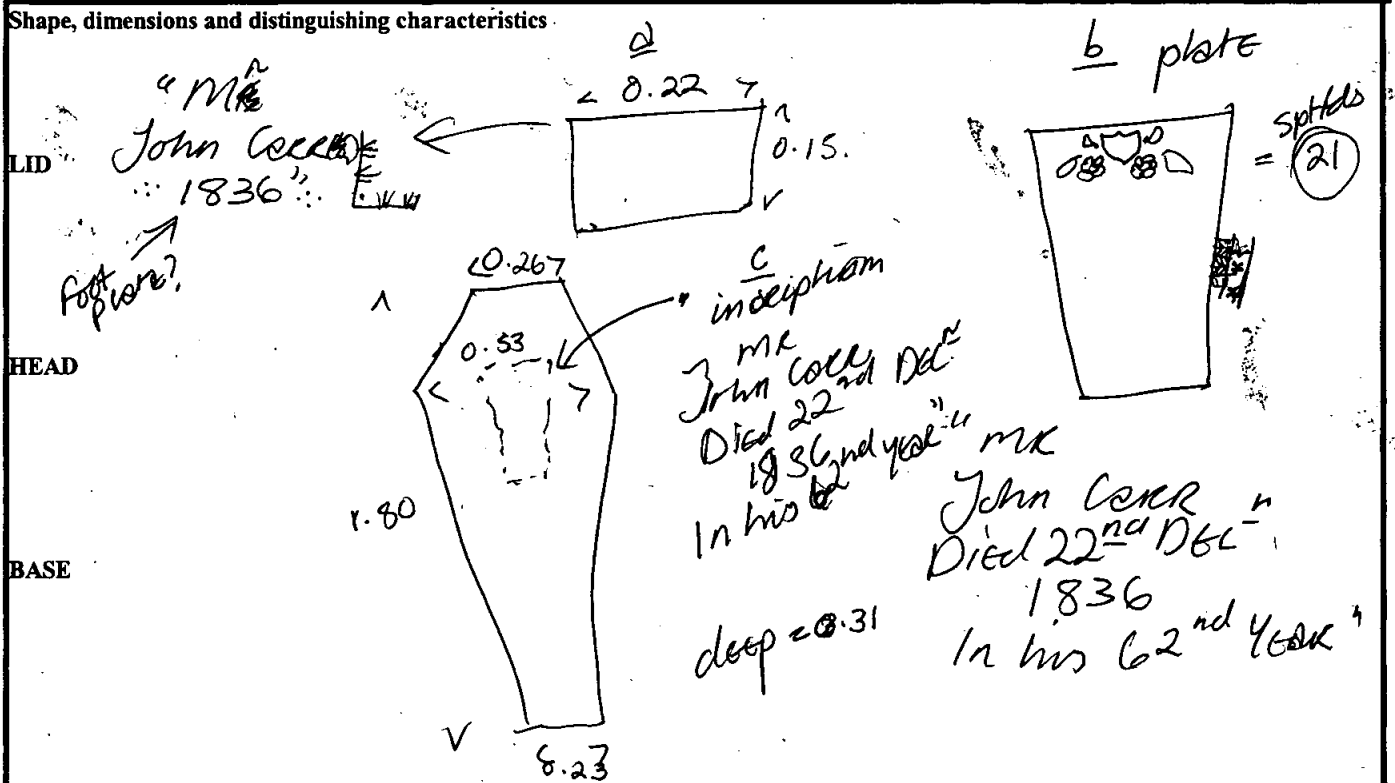

Recorder:	Date:	Initials:
-----------	-------	-----------

db.

SITE		COFFIN RECORD SHEET		CONTEXT NO.	
OL200				336	
Trench: CRMP7		Additional sheets: YES X1		Treatment: INTACT	
Site sub-div:		Grave fills		NO DNA SAMPLES TAKEN.	
Plan no: 7		Grave cut:		Finds	
				None	
Section no:		Skeleton:		Breastplate	
				Grip	
Co-ordinates:		Matrix location: in excavation Bay 3 under 256, 257, 258 & 259. (W)		Hinge	
				Bracket	
Levels		Preservation: 4		Fixing nails	
				Shroud pins	
Slide No.		Neg No:		Fabric	
				Other finds	

Description: adult p.b. coffin w/ black painted dec boarded on lid

Discussion:

Shape, dimensions and distinguishing characteristics

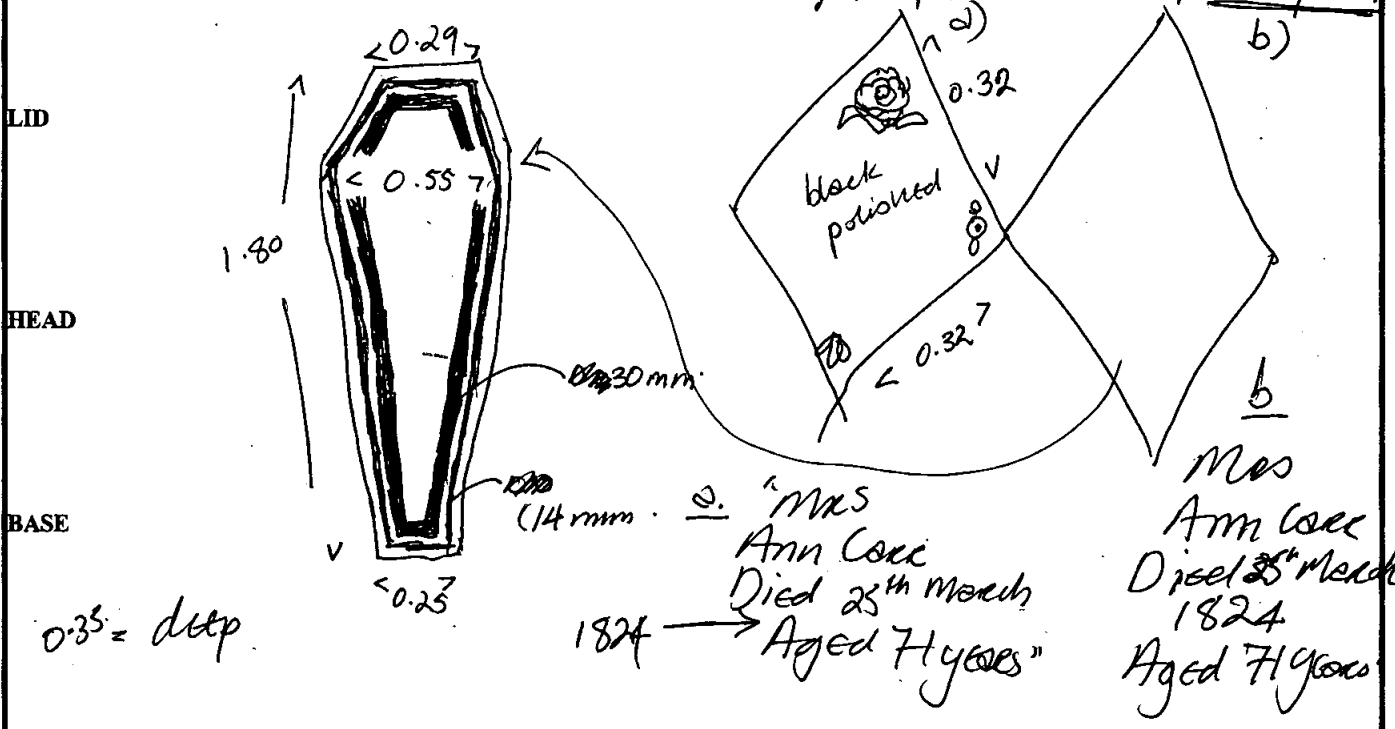

Recorder:	Date:	Initials:
-----------	-------	-----------

dp

SITE <i>OR 200</i>	COFFIN RECORD SHEET	CONTEXT NO. <i>337</i>
Trench: <i>CRYPT</i>	Additional sheets: <i>YES x 1</i>	Treatment: <i>INTACT.</i>
Site sub-div:	Grave fills	
Plan no: <i>7</i>	Grave cut:	Finds None
Section no:	Skeleton:	Breastplate <input checked="" type="checkbox"/> Grip <input checked="" type="checkbox"/> <i>x2</i>
Co-ordinates:	Matrix location: <i>in vault 11</i>	Hinge Bracket <i>up studs</i>
Levels	Preservation: <i>2.</i>	Fixing nails Shroud pins
Slide No.	Neg No:	Fabric Other finds

Description *infant p.b. coffin - intact, resting on bricks*

Discussion *- dekil single row in wood.*

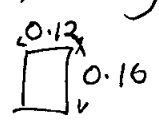

Shape, dimensions and distinguishing characteristics

LID *"Master Matthew"*

Died ... March 1808

HEAD *Aged 6 Mon ^{4 1/2}"*

BASE

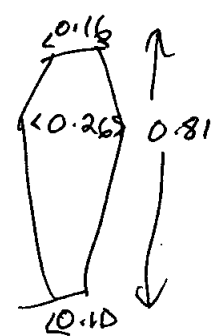

Full details on  sheet.

Recorder:	Date:	Initials:
-----------	-------	-----------

Coffin Recording Sheet

Site Code

Context

OHROO

337

Outer Coffin

Sample Ret.

Recording Date 25/7/00

Associated Numbers

Condition

Dep. Plate

Legible ish.

Inscription

Fabric lead ormolou brass tin plated pewter gilt tin
 iron silvered tin enamelled other Sample Ret.

Shape of dep. plate

square rectangle shield tapered lozenge
 cartouche oval other

Upholstery

colour shoddy velvet other Sample Ret.

Construction

butt joint mitred pitched other

Grip plate Fabric = ormolou brass tin plated pewter gilt tin
 iron silvered tin enamelled other Sample Ret.

Grip Fabric = ormolou brass iron x2 Sample Ret.

Design swag of rose horseshoe cherub's head plain

other *infant grips: term. to term = 0.08; ~~swag~~ drop = 0.04*

Grip bolts Corner bolts Type = gilt brass brass iron

other Sample Ret.

Lid motifs other Sample Ret.

Escutcheons other Sample Ret.

Upholstery ^{studs} nails brass gilt brass silvered brass iron enamelled

other Sample Ret.

Fixings panel nails screws hinges lace Sample Ret.

Timber type Sample Ret.

Interpretation / Comments

.....

dp.

SITE OLROO	COFFIN RECORD SHEET	CONTEXT NO. 338
Trench: CRYPT	Additional sheets:	Treatment: SKELLY LIFTED & DNA SAMPLE TAKEN.
Site sub-div:	Grave fills	
Plan no: 7	Grave cut:	Finds None dep. inscription.
Section no:	Skeleton:	Breastplate Grip ✓ x 1 fe. spit 4.
Co-ordinates:	Matrix location: Bay 3.	Hinge Bracket
Levels	Preservation:	Fixing nails up. studs. fe x 13 Shroud pins single row.
Slide No.	Neg No:	Fabric Other finds

Description adult p.b. coffin w/ dep. inscription.
pieces of silk? ruffe in chest area - shroud.

Discussion

Shape, dimensions and distinguishing characteristics

LID

HEAD

BASE

Lg. no. of bolts
fe. extent 3.5 cm x 5

p.b.

"Mr
~~Henry~~
Henry Stevens
Died 27th September
1826.
In his 23rd year

dep = 0.38.



broader detail
onto lid.

Recorder:	Date:	Initials:
-----------	-------	-----------

db

SITE	COFFIN RECORD SHEET	CONTEXT NO.
0LR00		339
Trench: CRYPT	Additional sheets: YES x 21	Treatment: SKULLY LIFTED - DNA TAKEN - NO SKULL = NO TEETH.
Site sub-div:	Grave fills	Finds None Inscription Breastplate ✓ x 1 p.b. Grip x 1, Fe. plate = grip ✓
Plan no: 7	Grave cut:	
Section no:	Skeleton:	Hinge Bracket + escutcheon ✓ up studs Fixing nails ✓ attached Shroud pins
Co-ordinates:	Matrix location: in vault 17 over 340	Fabric
Levels	Preservation: 2	Other finds
Slide No.	Neg No:	

Description sm. brick vault - 3 single deep w/ fe. spacer bases intact (x 4 orig - 3 remaining)
pb. lid completely destroyed - inner wooden case surviving.

Discussion ~~no trace of any of the plates~~ - no head
(5x keels:) $3\frac{1}{2} \times 3\frac{1}{2}$ cm
escutcheon: $8\frac{1}{2} \times 8\frac{1}{2}$ cms
spacers (13) in 2 sizes.

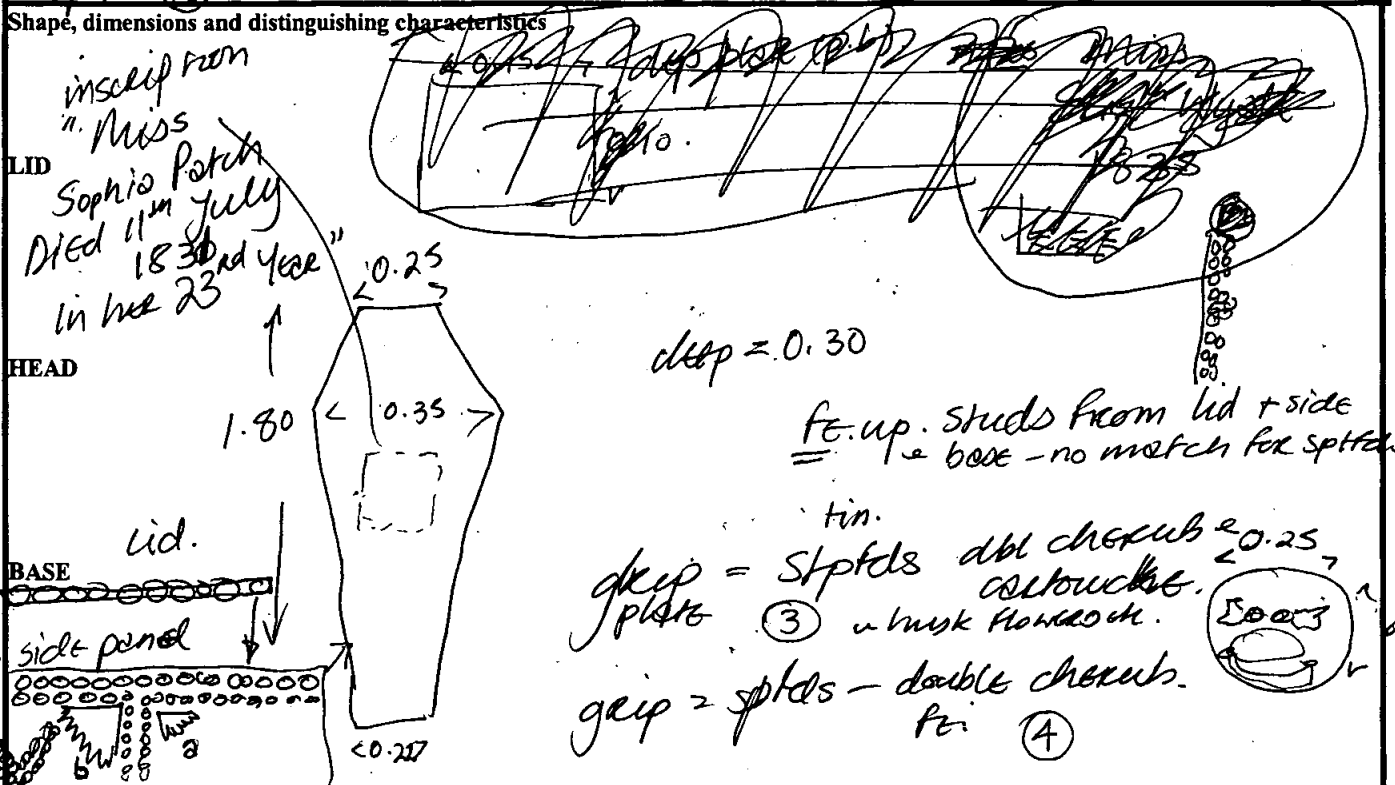

Recorder: _____ Date: _____ Initials: _____

base based. — base & lid studs bigger.

0200

339

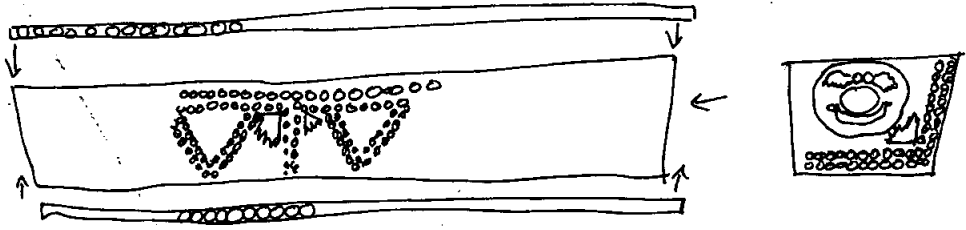

contd



40.

SITE	COFFIN RECORD SHEET	CONTEXT NO.
OLR00		341
Trench: CRYPT	Additional sheets:	Treatment: SKELETON DISINTEGRATED - NO DNA - LIFTED WHAT WAS POSS.
Site sub-div:	Grave fills	
Plan no: 7	Grave cut:	Finds None
Section no:	Skeleton:	Breastplate ✓ x 1 p. A ② Grip ✓ p. x 3 spit. ① - no plates, grips in situ
Co-ordinates:	Matrix location: in vault 17 under 340	Hinge - 1 x escutcheon in situ ① Bracket
Levels	Preservation: Skelly v. poor cond. w/ salts visible. due to beam & wood coffin?	Fixing nails Shroud pins
Slide No.	Neg No:	Fabric Other finds

Description ~~single~~ wooden coffin - butt joint fixed
single ~~beam~~ wood w/ hession? lining.
beam in bottom. 6x keel luts resting on brick floor in vault
17. 340 above resting on 3x Fe. bars muckered into vault walls &
339 above that resting on 3x Fe. bars.

Shape, dimensions and distinguishing characteristics

LID

HEAD

BASE

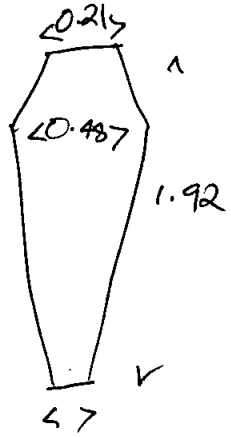
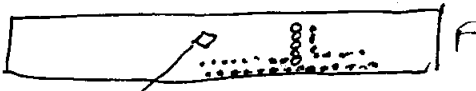
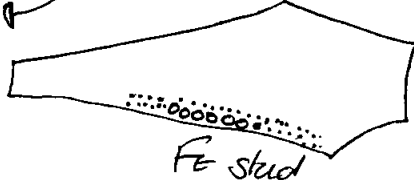

plate is some 20 340. (92) w/out shield
"Mr George
Patch Wyatt
Died 19th Sept^r
1809
In the 19th Year
of his wife"

stamped tin
broken
corroded

0.05
0.05
spits
escutcheon ①

Fe stud

Recorder:	Date:	Initials:
-----------	-------	-----------

db.

SITE	COFFIN RECORD SHEET	CONTEXT NO.
04200		342
Trench: CRMPT	Additional sheets:	Treatment: INTACT.
Site sub-div:	Grave fills	NO SAMPLES TAKEN.
Plan no: 7	Grave cut:	Finds
Section no:	Skeleton:	None
Co-ordinates:	Matrix location: in vault 15 under 307	Breastplate ✓ p.b. $\diamond \times 2 \diamond$
Levels	Preservation: 4	Grip
Slide No.	Neg No:	Hinge
		Bracket
		Fixing nails
		Shroud pins
		Fabric
		Other finds

Description p.b. adult coffin + 1 x soldered on dep "Miss
Discussion Martha Hughes
 Died 5th Dec
 1821
 In hex 17th year

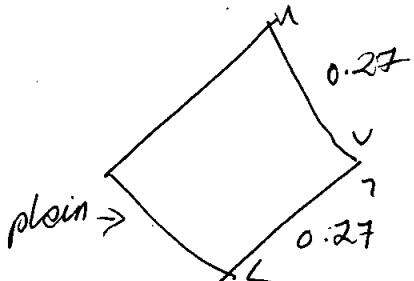

Shape, dimensions and distinguishing characteristics

LID

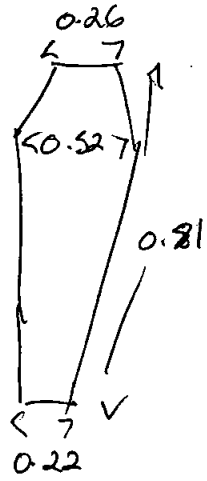

HEAD

BASE

deep = 0.36

"Miss
 Martha Hughes
 Died 5th Dec
 1821
 In Hex 17th year"

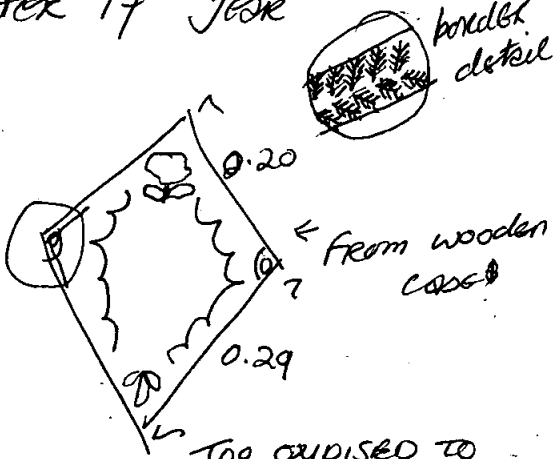

border detail

From wooden case

too oxidised to
 COMPLETELY I-D.

Recorder:	Date:	Initials:
-----------	-------	-----------

db

SITE OLR00	COFFIN RECORD SHEET	CONTEXT NO. 343
Trench: CRYPT	Additional sheets:	Treatment: SKELETON UPTED & DNA SAMPLES TAKEN
Site sub-div:	Grave fills	
Plan no: 7	Grave cut:	Finds None
Section no:	Skeleton:	Breastplate <input checked="" type="checkbox"/> BONES Grip
Co-ordinates:	Matrix location: IN VAULT 15 URAGE 305	Hinge Bracket up studs - Fe, frogs Fixing nails
Levels	Preservation: 1.	Shroud pins
Slide No.	Neg No:	Fabric Other finds

Description
p.b. skull coffin. "CHARLES STOKES
ESQ^{RE}
Died: 28th Dec.
1853
In his 70th year"

Discussion

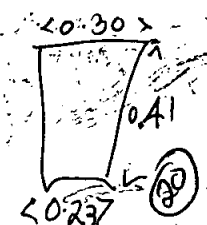

Shape, dimensions and distinguishing characteristics

inscription on p.b. lid - too oxidised & damaged to read.

LID

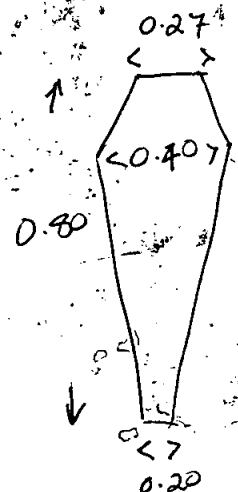

HEAD

BASE

Recorder:	Date:	Initials:
-----------	-------	-----------

db.

SITE	COFFIN RECORD SHEET	CONTEXT NO.
OLR00		344 344
Trench:	Additional sheets:	Treatment:
Site sub-div:	Grave fills	INTACT. NO SAMPLES TAKEN.
Plan no:	Grave cut:	Findings
Section no:	Skeleton:	None inscription on lid Breastplate Grip
Co-ordinates:	Matrix location: in vault 15 between 342 & 343; under 308?	Hinge Bracket
Levels	Preservation:	Fixing nails Shroud pins
Slide No.	Neg No:	Fabric Other finds

Description infant p.b. coffin on brick floor of vault

Discussion

Shape, dimensions and distinguishing characteristics

Diagram labels: LID (0.14), HEAD (0.77), BASE (0.09), depth = 0.22, deep = 0.20

" Mast^{er} David Hokes Hughes Died 22nd July 1818 Aged 8 weeks"

Recorder:	Date:	Initials:
-----------	-------	-----------

SITE <i>0200</i>		COFFIN RECORD SHEET	CONTEXT NO. <i>345</i>
Trench: <i>NL.</i>	Additional sheets:	Treatment:	
Site sub-div:	Grave fills		
Plan no: <i>3</i>	Grave cut:	Finds None	
Section no:	Skeleton:	Breastplate Grip	
Co-ordinates:	Matrix location: <i>'extras' body parts from BATS. 243</i>	Hinge Bracket	
Levels	Preservation:	Fixing nails Shroud pins	
Slide No.	Neg No:	Fabric Other finds :	
Description <i>only found when 345 analysed.</i>			
Discussion			
Shape, dimensions and distinguishing characteristics			
LID			
HEAD			
BASE			
Recorder:	Date:	Initials:	

SITE <i>OH200</i>	COFFIN RECORD SHEET		CONTEXT NO. <i>346</i>
Trench: <i>N.C.</i>	Additional sheets:		Treatment:
Site sub-div:	Grave fills		
Plan no: <i>3</i>	Grave cut:		Finds None
Section no:	Skeleton:		Breastplate Grip
Co-ordinates:	Matrix location: <i>adj. to 228 under 209</i>		Hinge Bracket
Levels	Preservation:		Fixing nails Shroud pins
Slide No.	Neg No:		Fabric Other finds :
Description <i>orig. bagged as part of 228 - different individual (m) - 228-f.</i>			
Discussion			
Shape, dimensions and distinguishing characteristics LID HEAD BASE			
Recorder:	Date:	Initials:	

SITE	COFFIN RECORD SHEET	CONTEXT NO.
0L200 Trench: N.C.	Additional sheets:	347 Treatment:
Site sub-div:	Grave fills	
Plan no: 3	Grave cut:	Finds None
Section no:	Skeleton:	Breastplate Grip
Co-ordinates:	Matrix location: <i>adj. to 222; 223 e 224. also to 348 e 349</i>	Hinge Bracket
Levels	Preservation:	Fixing nails Shroud pins
Slide No.	Neg No:	Fabric Other finds :
Description		
Discussion		
Shape, dimensions and distinguishing characteristics		
<i>mass buccial in coffin 222.</i>		
LID		
HEAD		
BASE		
Recorder:	Date:	Initials:

SITE <i>OH100</i>	COFFIN RECORD SHEET	CONTEXT NO. <i>348</i>
Trench: <i>N.C.</i>	Additional sheets:	Treatment:
Site sub-div:	Grave fills	
Plan no: <i>3</i>	Grave cut:	Finds None
Section no:	Skeleton:	Breastplate Grip
Co-ordinates:	Matrix location:	Hinge Bracket
Levels	Preservation: <i>adj. to 222, 223, 224, 347 & 349</i>	Fixing nails Shroud pins
Slide No.	Neg. No:	Fabric Other finds
Description		
Discussion		
Shape, dimensions and distinguishing characteristics <i>mass burial in coffin 222</i>		
LID		
HEAD		
BASE		
Recorder:	Date:	Initials:

SITE	COFFIN RECORD SHEET		CONTEXT NO.
0200	Additional sheets:		349
Trench: N.C.	Grave fills		Treatment:
Site sub-div:	Grave cut:		Finds
Plan no: 3	Skeleton:		None
Section no:	Matrix location: Adj. to 222, 223, 224, 347, 348		Breastplate
Co-ordinates:	Preservation:		Grip
Levels	Neg No:		Hinge
Slide No.	Shape, dimensions and distinguishing characteristics		Bracket
Description <i>mass burial in coffin 222.</i>			Fixing nails
			Shroud pins
Discussion			Fabric
			Other finds
LID			
HEAD			
BASE			
Recorder:	Date:	Initials:	

db.

SITE	COFFIN RECORD SHEET	CONTEXT NO.
02R00		744 350
Trench: CRMP1	Additional sheets:	Treatment: TOO POORLY PRESERVED - NO DNA POSS - BONES LEFT IN COFFIN - CANT LEFT
Site sub-div:	Grave fills	
Plan no: 7	Grave cut:	Findings
		None
Section no:	Skeleton:	Breastplate ✓ x 1 p.b. (a)
		Grip + plate x 1 grip = sword pommel plate = abdominal plate
Co-ordinates:	Matrix location: in vault 13	Hinge (Fe) (11A)
		Bracket (3) (3)
Levels	Preservation: v. poor	up studs ✓
		Fixing nails
Slide No.	Neg No:	Shroud pins
		Fabric
		Other finds

Description Vault 13 has 2 x brick runners w/ wooden timber on top
hession-timbered, full of beam, s'kelly destroyed.



— viewing window

Discussion

S.F. Δ

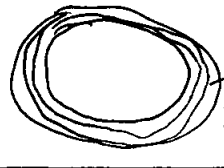

black bordered w/ gilt inner band glass

Shape, dimensions and distinguishing characteristics

LID

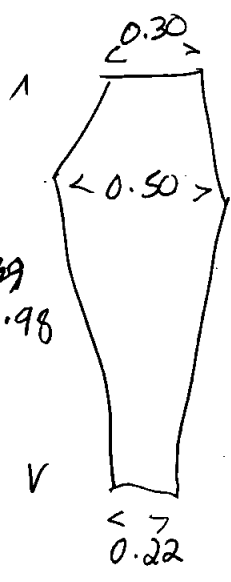

depth = 0.35.



Fe up sword
brass up hilt

"Mr Bowes Todd
Died 8th Augst
1800
Aged 32 Years"
us shield

HEAD

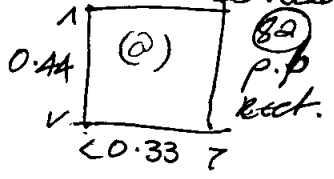
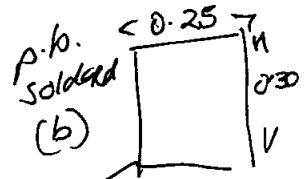

BASE

"Mr Bowes Todd
Died 8th Aug
1800
Aged 32 years"

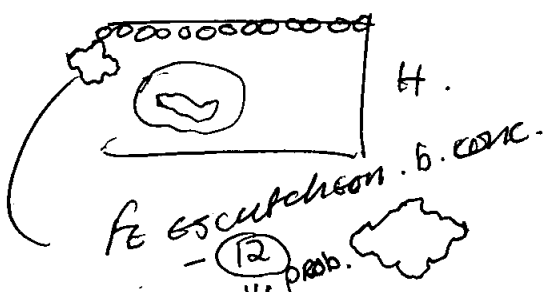

Recorder:	Date:	Initials:
-----------	-------	-----------

db

SITE OLR00	COFFIN RECORD SHEET	CONTEXT NO. 351
Trench: CRYPT	Additional sheets:	Treatment: SKELETON LIFTED - NO SKULL - NO DNA - - NO NAME,
Site sub-div:	Grave fills	
Plan no: 7	Grave cut:	Finds None
Section no:	Skeleton:	Breastplate Grip
Co-ordinates:	Matrix location: in Box 3	Hinge Bracket
Levels	Preservation: 2	Fixing nails Shroud pins
Slide No.	Neg No:	Fabric Other finds

Description
p.b. coffin, poor condition. opened.
no plate on lid, on side - 6x keef cuts
on inner wooden case.

Discussion

Shape, dimensions and distinguishing characteristics

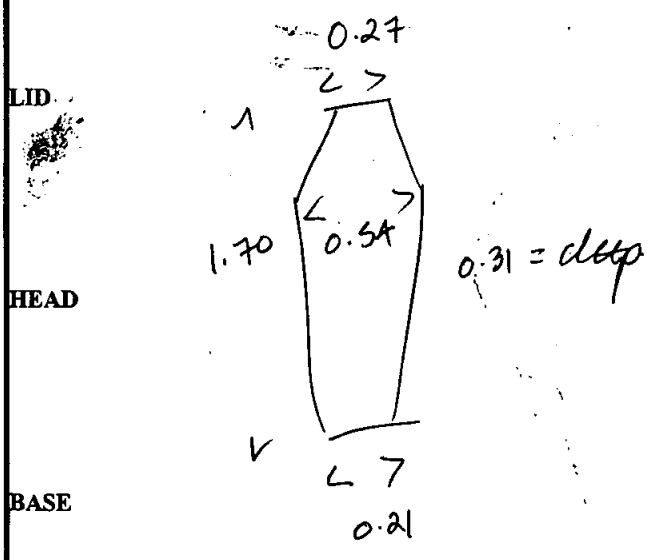

Recorder:	Date:	Initials:
-----------	-------	-----------

110

SITE OLR00	COFFIN RECORD SHEET	CONTEXT NO. 352
Trench: CRYPT	Additional sheets: YES X1	Treatment: SKELETON DISINTEGRATED ON HANDLING - NO DNA - V. POOR. BONES NOT KEPT.
Site sub-div:	Grave fills	
Plan no: 7	Grave cut:	Findings
Section no:	Skeleton:	None dep. inscrip. + dep. plate p.k. Breastplate (x2) Grip 
Co-ordinates:	Matrix location: m Bay 3 adj. to 353	Hinge Bracket
Levels	Preservation: 1-	Fixing nails Shroud pins
Slide No.	Neg No:	Fabric Other finds

Description sub adult p.b coffin - bones ruptured; v. little left inside except coffin lid (upside down) ~~the~~ some hair.

Discussion

Shape, dimensions and distinguishing characteristics

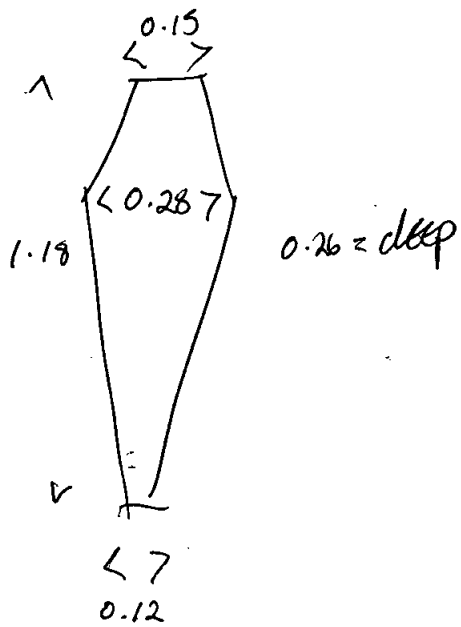

LID

HEAD

BASE

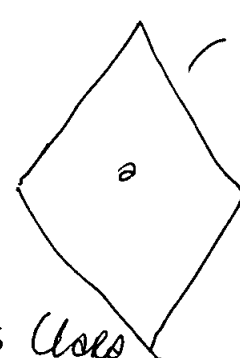

double punched design border on lid

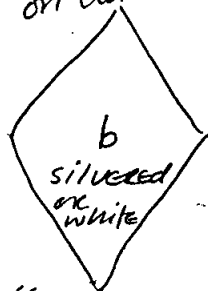

b
silvered
or white

"Miss Udo
Matilda ~~Dea~~ Cuerton
Died 12th May
1830
Aged 4 years"

"Miss Udo
Matilda Cuerton
Died 12th May
1830
Aged 4 years"

Recorder:	Date:	Initials:
-----------	-------	-----------

db.

SITE	COFFIN RECORD SHEET	CONTEXT NO.
04200		353
Trench: <i>CRYPT</i>	Additional sheets:	Treatment: <i>SKELETON LIFTED - DISTURBED - NO DNA TAKEN.</i>
Site sub-div:	Grave fills	
Plan no: <i>7</i>	Grave cut:	Finds None <i>dep. inscription.</i>
Section no:	Skeleton:	Breastplate Grip
Co-ordinates:	Matrix location: <i>in Bay 3. adj. to 352 & 354</i>	Hinge Bracket
Levels	Preservation:	Fixing nails Shroud pins
Slide No.	Neg No:	Fabric Other finds

Description *infant p.p. coffin - ruptured - found up side down. hessian-lined in near wood case*

Discussion

Shape, dimensions and distinguishing characteristics

inscription on lid.

LID

HEAD

BASE

Thomas Mast^s
Thomas Cuckton
Son of
Charles & Clara
Died 13 Dec^r
∴ 1814 ∴
Aged 12 Months.

border detail

Recorder:	Date:	Initials:
-----------	-------	-----------

db

SITE <i>02100</i>	COFFIN RECORD SHEET	CONTEXT NO. <i>354</i>
Trench: <i>CRYPT.</i>	Additional sheets:	Treatment: <i>SKELETON LIFTED.</i> <i>- NO DNA (UNNAMED.)</i>
Site sub-div:	Grave fills	
Plan no: <i>7.</i>	Grave cut:	Finds None
Section no:	Skeleton:	Breastplate Grip
Co-ordinates:	Matrix location: <i>adj. to 353 Boy 3.</i>	Hinge Bracket
Levels	Preservation:	Fixing nails Shroud pins
Slide No.	Neg No:	Fabric Other finds

Description *infant p-b. coffin - on top of spoil heap - no named. bottom ruptured. Poss. in wadded shroud or lining used as shroud i.e.*

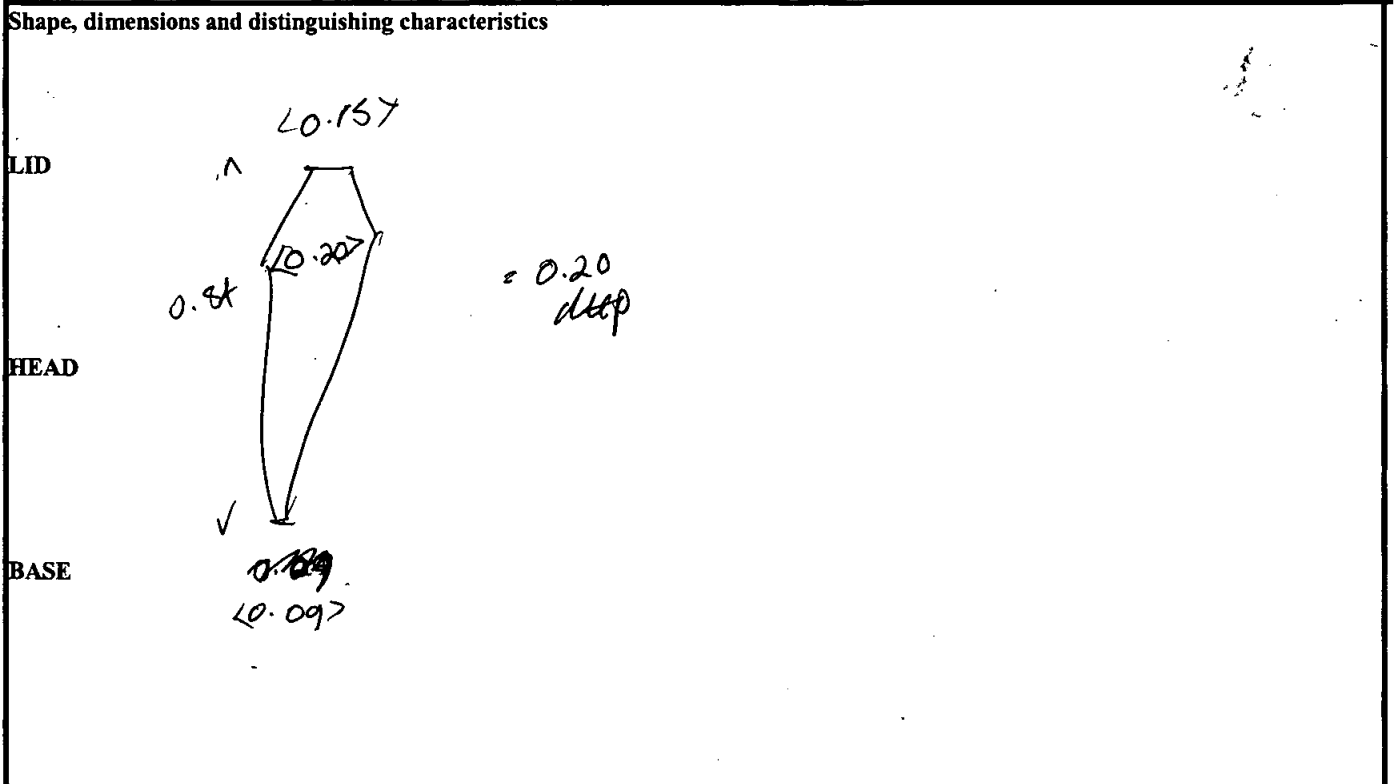

Recorder:	Date:	Initials:
-----------	-------	-----------

db

SITE	COFFIN RECORD SHEET	CONTEXT NO.
OHROO		355
Trench: CRYPT	Additional sheets:	Treatment: SKELETON LIFTED - DNA TAKEN.
Site sub-div:	Grave fills	
Plan no: 7	Grave cut:	Finds None dep plate soldered. p.b.
Section no:	Skeleton:	Braceplate Grip
Co-ordinates:	Matrix location: in Bay 3	Hinge Bracket
Levels	Preservation: 2	Fixing nails Shroud pins
Slide No.	Neg No:	Fabric Other finds

Description: adult p.b. coffin

Discussion: a Charles Cuerton
Esq^r
Died 10th March
∴ 1842 ∴
Aet 60

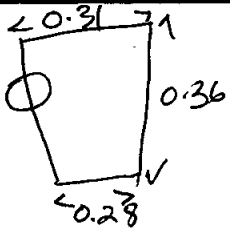

Shape, dimensions and distinguishing characteristics

LID

HEAD

BASE

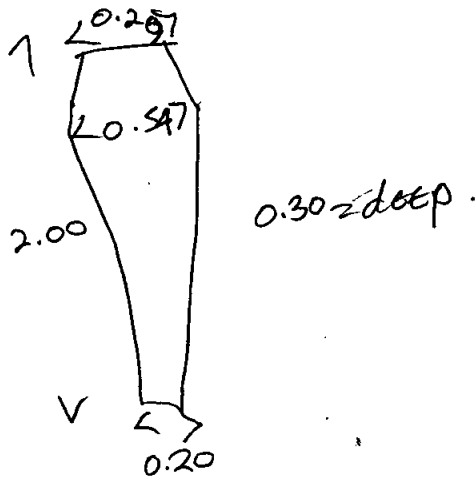

0.30 = deep.

Recorder:	Date:	Initials:
-----------	-------	-----------

db

SITE OLR00	COFFIN RECORD SHEET	CONTEXT NO. 356
Trench: CRMPT	Additional sheets:	Treatment: BONED TOO DEGRADED TO LIFT-ONLY FRAGS RECOVERED
Site sub-div:	Grave fills	
Plan no: 7	Grave cut:	Finds None dep plate p.b. ect. soldered
Section no:	Skeleton:	Breastplate Grip
Co-ordinates:	Matrix location: in Bay 3	Hinge Bracket
Levels	Preservation: 1	Fixing nails Shroud pins
Slide No.	Neg No:	Fabric Other finds

Description *Adult p.b. coffin*

Discussion *Skeleton poorly preserved; coffin ruptured.
in nec wooden case, 6 x keels.*

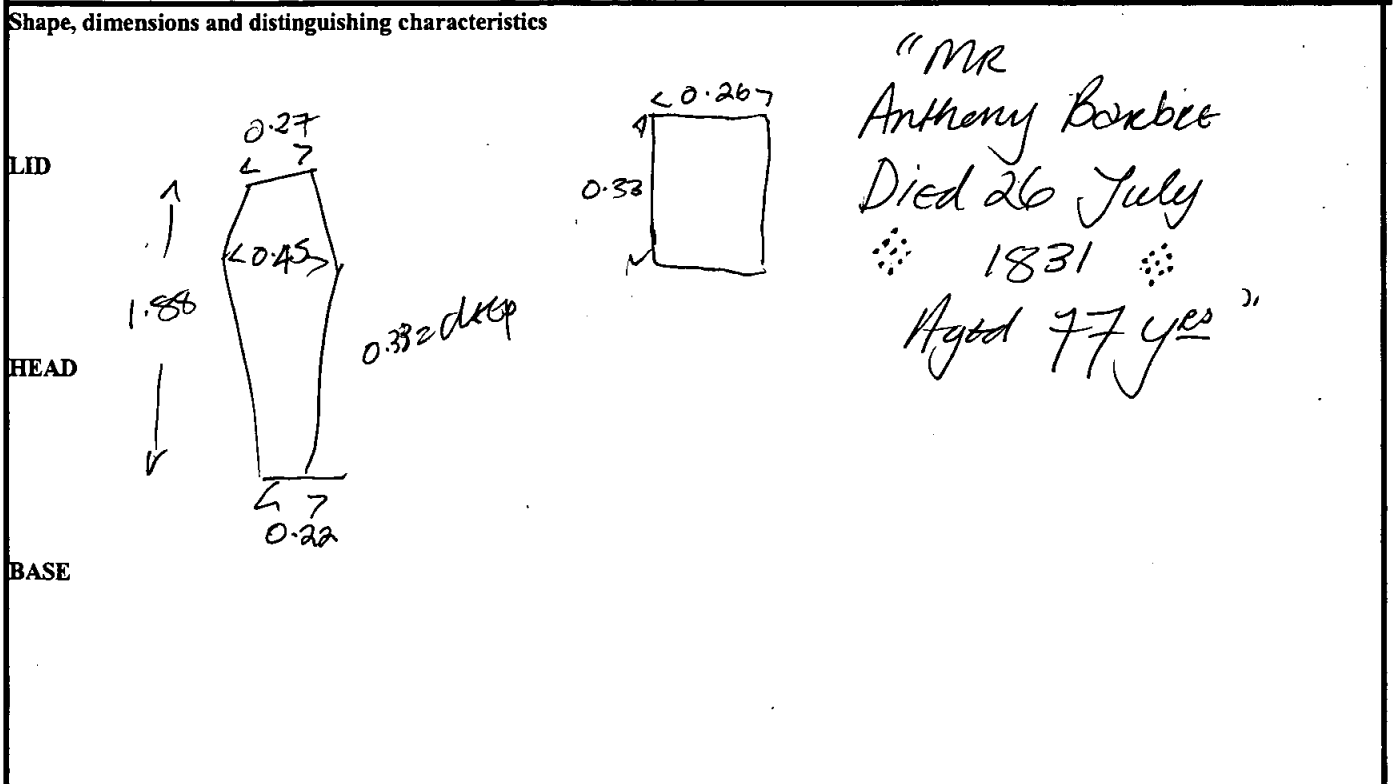

Recorder:	Date:	Initials:
-----------	-------	-----------

db

SITE OLR00	COFFIN RECORD SHEET	CONTEXT NO. 357
Trench: CRYPT	Additional sheets:	Treatment: SKELETON LIFTED.
Site sub-div:	Grave fills	
Plan no: 7	Grave cut:	Finds None
Section no:	Skeleton:	Breastplate Grip
Co-ordinates:	Matrix location: in bay 3	Hinge Bracket
Levels	Preservation: 0.5!	Fixing nails Shroud pins
Slide No.	Neg No:	Fabric Other finds

Description
 v. poor cond. adult p.b. coffin - lid destroyed - no name.
 interior full of soil - was closed?

Discussion

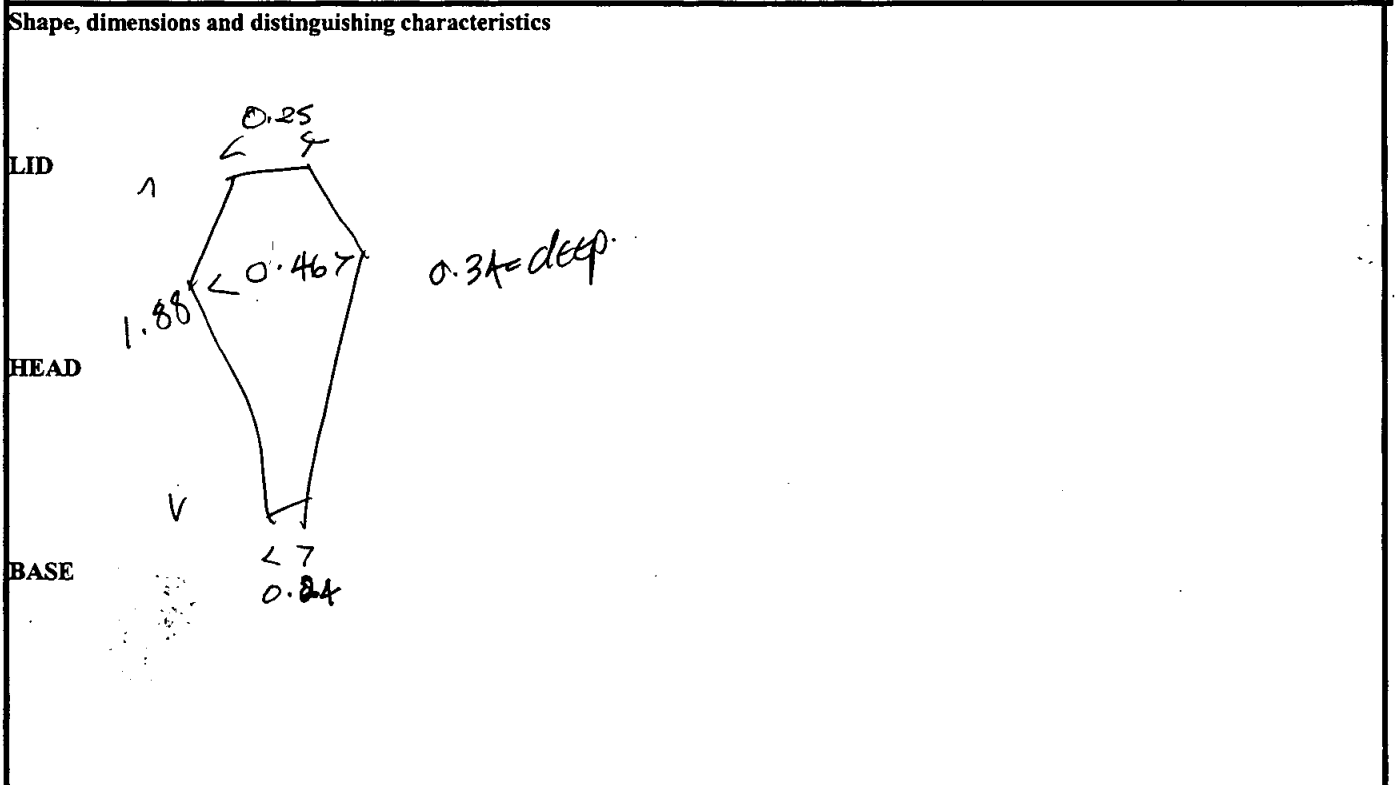

Recorder:	Date:	Initials:
-----------	-------	-----------

SITE OLR00	CONTEXT RECORD	Context No. 358
	Additional Sheets:	Type LAYER
Trench	Context Type: Deposit / Cut / Structure	Check Lists:
Site sub-div NC.	Overlain by:	DEPOSIT: 1.compaction 2.colour 3.composition 4.inclusions 5.thickness 6.extent 7.comments 8.method & conditions
Structure No.	Abutted by:	
Plan No.	Cut by:	CUT: 1.shape in plan 2.base/sides/top profile 3.dimension and depth 4.sketch 5.truncation 6.fill nos 7.other comments
	Filled by:	
Section No. 10	Same as:	MASONRY: 1.materials 2.size of bricks etc 3.finish of stones 4.coursing/bond 5.form 6.faces 7.bond 8.dimensions as found 9.other comments
	Part of:	
Co-Ordinates	Consists of:	
	Overlies:	
Level	Butts:	
Slide No.	Cuts:	
Neg No.	Fill of:	
Matrix location	Relationships uncertain	
Description (See check lists):		<p style="text-align:center;">STRATIGRAPHIC MATRIX</p>
① Friable		
② Light buff brown		
③ Sandy silt/clay.		
④ -		
⑤ ?		
⑥ ?		
⑧ machined.		
Interpretation/Discussion: Brickearth? Probable <u>NATURAL</u> .		
Finds (tick): None <input type="checkbox"/> Pot <input type="checkbox"/> Bone <input type="checkbox"/> Flint <input type="checkbox"/> Stone <input type="checkbox"/> Burnt stone <input type="checkbox"/> Glass <input type="checkbox"/> Metal <input type="checkbox"/> CBM <input type="checkbox"/> Wood <input type="checkbox"/> Leather <input type="checkbox"/>		
ΔSmall Finds	Recorder JS	
◇Samples	Date 27/9	
△Building Materials	Initials	

dp

SITE <i>02R00</i>	COFFIN RECORD SHEET	CONTEXT NO. <i>359</i>
Trench: <i>CRYPT</i>	Additional sheets:	Treatment: <i>SKELETON LIFTED</i> <i>-NO DNA - TOO BADLY PRESERVED:</i>
Site sub-div:	Grave fills	
Plan no: <i>7</i>	Grave cut:	Finds None
Section no:	Skeleton:	Breastplate Grip
Co-ordinates:	Matrix location:	Hinge Bracket
Levels	Preservation:	Fixing nails Shroud pins
Slide No.	Neg No:	Fabric Other finds

Description *adult ~~box~~ coffin: ~~wood~~; rectangular (no shoulders) w/ inner shouldered wooden ^{zn} box. Poss. re-contained burial. Slightly twisted/buckled. Wooden base board (on which poorly preserved remains sat) w/*

Discussion *2nd wooden board underneath (w/ keel cuts) - 3rd wooden board (w/ keel cuts) with thick bed of wood shavings which looks like straw.*

Shape, dimensions and distinguishing characteristics

LID

HEAD

BASE

On surface of redeposited soil.

Interpretation: wooden coffin collapsed in crypt, zn box to contain it - put sides in first, then remains on base board put in on top of that - zn box soldered.

Recorder:	Date:	Initials:
-----------	-------	-----------

dp

SITE	COFFIN RECORD SHEET	CONTEXT NO.
OLR00		360
Trench:	Additional sheets:	Treatment: SKELETON LIFTED - NO NAME - NO DNA.
Site sub-div:	Grave fills	
Plan no:	Grave cut:	Finds None inscription 
Section no:	Skeleton:	Breastplate Grip
Co-ordinates:	Matrix location: in Bay 3	Hinge Bracket
Levels	Preservation:	Fixing nails Shroud pins
Slide No.	Neg No:	Fabric Other finds

Description infant p.b. coffin. badly mangled. inner wooden case. Upside down - opened through bottom

Discussion

Shape, dimensions and distinguishing characteristics

LID

HEAD

BASE

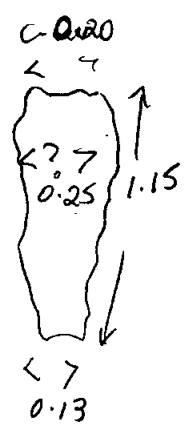

0.262 deep

" Miss
Emma Goedner
Died 20th May
1825
Aged 5 Years
11 Months "
w/ plain punched border.

Recorder:	Date:	Initials:
-----------	-------	-----------

NP

SITE	COFFIN RECORD SHEET	CONTEXT NO.
ORL00		361
Trench: CRYPT	Additional sheets: YES x 1	Treatment: SKELETON LIFTED ✓ DNA TAKEN
Site sub-div:	Grave fills	
Plan no: 7	Grave cut:	Finds None
Section no:	Skeleton:	Breastplate ✓ p.p. tapered + inscrip. (top) Grip
Co-ordinates:	Matrix location: in vault 12 adj. to 30A, over 303	Hinge Bracket
Levels:	Preservation:	Fixing nails Shroud pins
Slide No.	Neg No:	Fabric Other finds

Description named adult p.b. coffin. v. good preservation of facial hair - i.e. sideburns & head hair.

Discussion

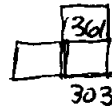

Shape, dimensions and distinguishing characteristics

LID

HEAD

BASE

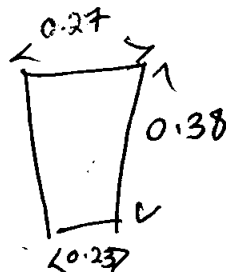
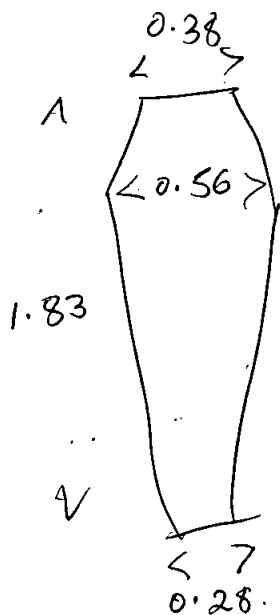

inscription

"Thomas Sowler
Esq"
Died 11th April
1845
in his 76th yr"
plate
black enamelled
"Thomas Sowler
Esq^r Died 11th April
1845
in his 76th year"

Recorder:

Date:

Initials:

db.

SITE	COFFIN RECORD SHEET	CONTEXT NO.
02100		362
Trench: <i>CRYPT</i>	Additional sheets: <i>YES X 2</i>	Treatment: <i>SKELLY LIFTED</i>
Site sub-div:	Grave fills	<i>DNA SAMPLES</i> <i>(NO TEETH) TAKEN</i>
Plan no: <i>7</i>	Grave cut:	Finds None <i>10.257</i>
Section no:	Skeleton:	Breastplate <input checked="" type="checkbox"/> <i>0.267</i> <i>a</i> plain Grip <input checked="" type="checkbox"/> <i>2</i> <input checked="" type="checkbox"/> <i>b</i> (<i>top</i>)
Co-ordinates:	Matrix location: <i>in bay 3</i> <i>over 363</i> <i>in vault 16</i>	Hinge
Levels	Preservation: <i>2</i>	Bracket
Slide No.	Neg No:	Fixing nails
		Shroud pins
		Fabric
		Other finds

Description *adult p.b. coffin w/ large perforation in pb head panel:*
(vault has brick floor, was 1/2 filled w/ spoil)

Discussion

Shape, dimensions and distinguishing characteristics

① Miss Ann Brown
Died 9th Dec. 1823
Aged ~~83~~ 83 Years

② Miss Ann Brown
Died 9th Dec^R 1823
Aged 83 Years

Recorder:	Date:	Initials:
-----------	-------	-----------

db

SITE	COFFIN RECORD SHEET	CONTEXT NO.
CRAPT or 100		363
Trench: CRAPT	Additional sheets: YES x 1	Treatment: SKELLY LIFTED DNA SAMPLES TAKEN.
Site sub-div:	Grave fills	
Plan no: 7	Grave cut:	Finds None dep plate Breastplate Grip
Section no:	Skeleton: under 362 in vault 16 - Bay 3	dep plate inscription dep plate p.b. (b)
Co-ordinates:	Matrix location:	Hinge Bracket
Levels	Preservation: 3	Fixing nails Shroud pins
Slide No.	Neg No:	Fabric Other finds

Description: adult p.b. coffin / w traces of wood f.c. up. shuds. Plate (b)

sub adult. ~~inscription~~ "Master Keith Stewart
Died 29th April 1822
In his 13th Year"

Discussion: "Master Keith Stewart
Died 29th April 1822
In the 13th Year of his Age"

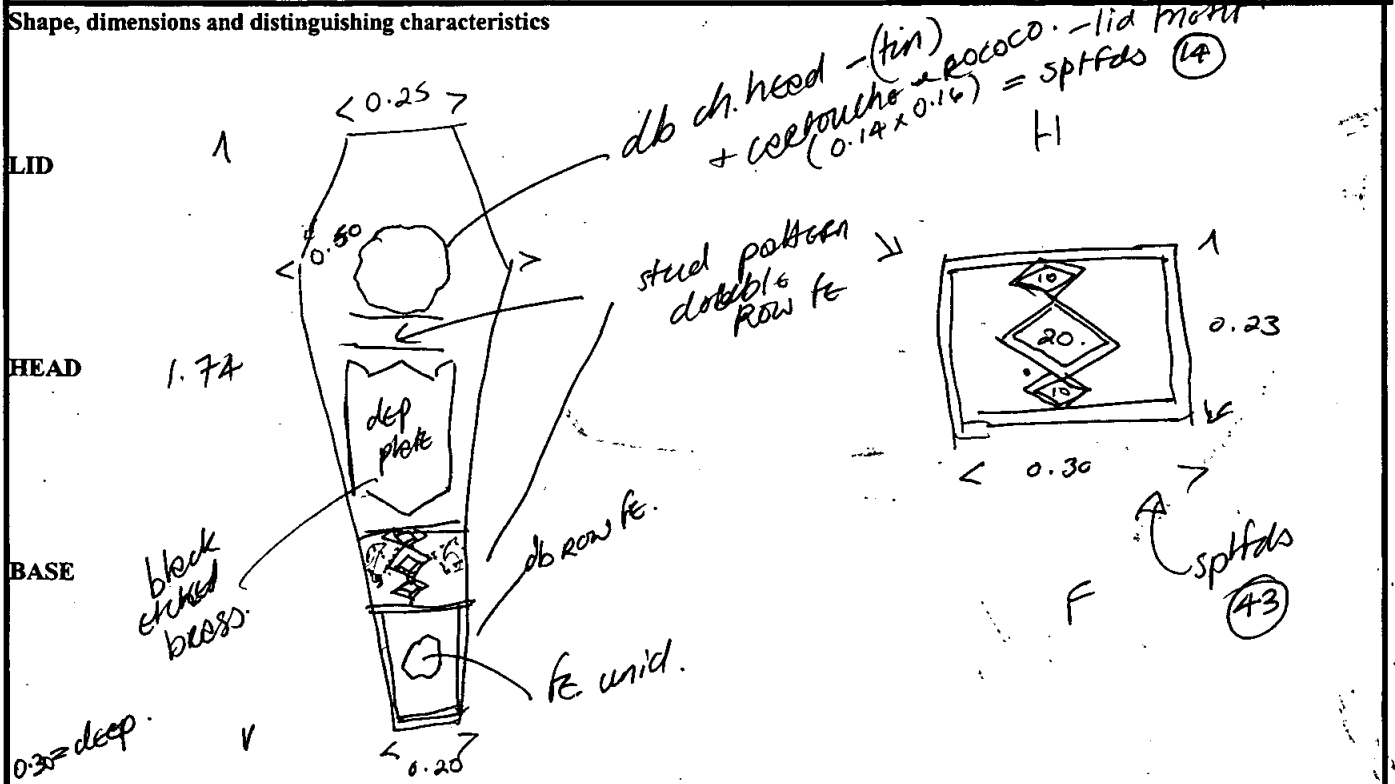

Recorder: _____ Date: _____ Initials: _____

db.

SITE	COFFIN RECORD SHEET	CONTEXT NO.
OLR00		36A
Trench: CRYPT	Additional sheets:	Treatment: SKELETON WATED & DNATAKEN.
Site sub-div:	Grave fills	
Plan no: 7	Grave cut:	Finds None
Section no:	Skeleton:	Breastplate x1 p.b. <input type="checkbox"/> x1 p.b. <input type="checkbox"/> soldered. Grip x2 p.e. sptfds (4) b
Co-ordinates:	Matrix location: under 465, 466. adj. to 363. vault 16 - not tied into	Hinge Bracket up-studs - p.e. strips.
Levels	Preservation: 1 crypt well & casing	Fixing nails Shroud pins
Slide No.	Neg No:	Fabric Other finds

Description Adult p.b. Coffin - shrouded remains - linen? in the wooden case has 5x kerf cuts: - appeared to have horse hair mattress.

Discussion

Shape, dimensions and distinguishing characteristics

LID

0.26
0.22
1.78
0.34 = depth

HEAD

⑤ "Mrs Sarah Hathorn
Died 4th April 1807
Aged 35 Years"

BASE

⑥ "Mrs Sarah Hathorn
Died 4th April 1807
Aged 35 Years"

plate ③ = sptfds ⑥ what over boarder.

0.41
0.31

coffins sitting on timber runnes on brick floor.

Recorder:	Date:	Initials:
-----------	-------	-----------

Islington, Old Street, St Lukes
CLROD

Box 2 File 5

B. PRIMARY CONTEXT RECORDS - N^o 365-497

SCAN PDF

FILMING INSTRUCTIONS

Submitter OASouth

No. of CD copies: 2

Headings

Site information

Line 1: [OASouth] County:[Greater London] Parish:[Islington] Site:[Old Street, St Lukes]

Site code[OLR00]

Line 2: Excavators name[A. Boyle]

Line 3:

Classification of material

Tick if present

Index to archive	
Introduction	
A:Final Report	
A:Publication Report	
B:Site Data – Text: Diary/Daybook/Fieldnotes	
B: Site Data – Text: General Summaries	
B: Site Data – Text: Primary Context Records <i>no 365-497</i>	<input checked="" type="checkbox"/>
B: Site Data – Text: Synthesised Context Records	
B: Site Data – Text: Survey Reports	
B: Site Data – Text: Catalogue of Drawings	
B: Site Data – Text: Primary Drawings	
B: Site Data – Text: Synthesised Drawings	
C: Finds Data – Text: Primary Finds Data	
C: Finds Data – Text: Synthesised Finds Data	
C: Finds Data – Text: Specialist Reports	
C: Finds Data – Text: Box/Bag List	
D: Catalogue of Photos/Slides/Videos/X--rays	
E: Environmental/Ecofact Data: Primary Records	
E: Environmental/Ecofact Data: Synthesised Records	
E: Environmental/Ecofact Data: Specialist Reports	
F: Documentary	
F: Press and Publicity	
G: Correspondence	
H: Miscellaneous	

SITE CODE: OLR00		CONTEXT CHECKLIST			SITE: ST LUKES CHURCH NAME: ISLINGTON			
Context No	Type	Excavated with Segments	Relationships	Dug	Drawn		Matrix NAMED	Comments
					Section	Plan		
B 365	BURIAL	NC		DH/AN DS.		3		Burial
B 366	BURIAL		over 319					Burial
B 367	BURIAL		u/lies 366 319					BURIAL
B 368	BURIAL		u/lies 318					BURIAL
B 369	"							"
B 370	"		over 371					"
B 371	"		u/lies 370					"
B 372	"							"
B 373	"		u/lies 374					"
B 374	"							In lead coffin
B 375	"		o/lies 376					Burial
B 376	"		u/lies 375					Burial
B 377	"		o/lies 378					Burial - child
B 378	"		o/lies 381 u/lies 377					BURIAL
B 379	"		u/lies 382 o/lies 380					BURIAL
B 380	"		u/lies 379					BURIAL
B 381	"		u/lies 378 o/lies 384					BURIAL
B 382	"		o/lies 379					BURIAL - child
B 383	"		o/lies 385					BURIAL
B 384	"		below 381					BURIAL
B 385	"		o/lies 383 ASSOC WITH 388					BURIAL IN LEAD COFFIN
B 386	"		o/lies 387		10			"
B 387	"		386 u/lies 386		10			"
B 388	"		ASSOC WITH 385					CHILD BURIAL RELATIONSHIP UNUSUAL
B 389	"		u/lies 384 u/lies 390					BURIAL
B 390	"		o/lies 387					"
B 391	"		o/lies 392					" CRANIOTOMY
B 392	"		u/lies 391 o/lies 393					"
B 393	"		u/lies 392 o/lies 394				Y	"
B 394	"		u/lies 393					"
B 395	"		o/lies 396					"
B 396	"		u/lies 395 u/lies 397					" LEAD COFFIN
B 397	"	V	u/lies 396				V	" LEAD COFFIN

SITE		CONTEXT			SITE STRUKES CHURCH			
CODE: OL200		CHECKLIST			NAME: SELINGTON			
Context No	Type	Excavated with Segments	Relationships	Dug	Drawn		Matrix NAMED?	Comments
					Section	Plan		
B 398	Burial	NC	o/lies 399	DIFF/AN		3		Burial
B 399	Burial		u/lies 399					BURIAL
B 400	Burial		u/lies 399 o/lies 403/4					BURIAL
B 401	Burial		o/lies 402					CHILD BURIAL
B 402	Burial		u/lies 401					ADULT BURIAL
B 403	Burial		u/lies 400					CHILD
B 404	Burial		u/lies 400					CHILD
B 405	Burial		o/lies 406					Baby BURIAL
B 406	Burial		u/lies 405					Juvenile Burial.
B 407	"		o/lies 408					BURIAL
B 408	"		u/lies 407					"
B 409	"		Truncated by 410 + vault.					" Bad leg.
B 410	"		Truncates 409 u/lies 412 - o/lies 414.					Adult Burial.
B 411	"		u/lies 412 SITE. NONE					Adult Burial.
B 412	"		o/lies 410					Baby
B 413	"		u/lies 399					legs - rest truncated.
B 414	"		u/lies 410					Adult Burial.
B 415	"							" "
B 416	"							" "
B 417	"							" "
B 418	"		o/lies 421					" "
B 419	"							" "
B 420	"		u/lies 422					" "
B 421	"		u/lies 418					" "
B 422	"		u/lies 420 o/lies 423					" "
B 423	"		u/lies 422 u/lies 425					BABY BURIAL
B 424	"		u/lies 425 o/lies 426					ADULT BURIAL
B 425	"		u/lies 423 o/lies 424					BABY BURIAL
B 426	"		u/lies 424					ADULT BURIAL
B 427	"							" "
B 428	"		o/lies 429					" "
B 429	"		o/lies 428 o/lies 433					" "
B 430	"		u/lies 431 o/lies 435					" "

Valuation 29/9/00

BURIALS THIS SHEET = 33

SITE		CONTEXT				SITE		NAME:	
CODE: <i>OR00</i>		CHECKLIST				ST. LUKE'S CHURCH			
Context No	Type	Excavated with Segments	Relationships	Dug	Drawn		Matrix	Comments	
					Section	Plan			
<i>* 464</i>	<i>VOIDED</i>								
<i>- 465</i>	<i>Burial</i>	<i>CRYPT</i>	<i>in vault 16 over 364</i>	<i>MR/D</i>		<i>7</i>		<i>intact infant p.b coffin</i>	
<i>- 466</i>	<i>Burial</i>	<i>CRYPT</i>	<i>over 364</i>	<i>MR/D</i>		<i>7</i>	<i>Y</i>	<i>" " "</i>	
<i>DNA/B 467</i>	<i>Burial</i>	<i>CRYPT</i>	<i>Bay 3/4 far end</i>	<i>MR/D</i>		<i>7</i>	<i>Y</i>	<i>adult p.b coffin</i>	
<i>DNA/B 468</i>	<i>Burial</i>	<i>CRYPT</i>		<i>MR/D</i>		<i>7</i>	<i>Y</i>	<i>adult p.b coffin</i>	
<i>DNA/B 469</i>	<i>Burial</i>	<i>CRYPT</i>		<i>MR/D</i>		<i>7</i>	<i>Y</i>	<i>adult p.b coffin</i>	
<i>470</i>	<i>MOD STRUCTURE</i>	<i>CRYPT</i>	<i>BAY 1 contains 471-474</i>	<i>DS</i>		<i>7</i>		<i>Probable vault (dismantled) at east end of Bay 1</i>	
<i>- 471</i>	<i>BURIAL</i>	<i>CRYPT</i>	<i>BAY 1 VAULT 470.</i>	<i>MR/DS</i>		<i>7</i>	<i>Y</i>	<i>Pb coffin burial.</i>	
<i>DNA/B 472</i>	<i>BURIAL</i>	<i>CRYPT</i>				<i>7</i>	<i>Y</i>	<i>Pb coffin burial.</i>	
<i>B 473</i>	<i>BURIAL</i>	<i>CRYPT</i>				<i>7</i>		<i>Pb coffin burial</i>	
<i>B 474</i>	<i>BURIAL</i>	<i>CRYPT</i>				<i>7</i>		<i>Pb coffin burial.</i>	
<i>DNA 475</i>	<i>Burial</i>	<i>CRYPT</i>	<i>Bay 3</i>	<i>MR/DS</i>		<i>7</i>	<i>Y</i>	<i>p.b coffin</i>	
<i>- 476</i>	<i>Burial</i>	<i>CRYPT</i>				<i>7</i>	<i>Y</i>	<i>intact p.b. coffin</i>	
<i>DNA/B 477</i>	<i>Burial</i>	<i>CRYPT</i>				<i>7</i>	<i>Y</i>	<i>p.b coffin</i>	
<i>DNA/B 478</i>	<i>Burial</i>	<i>CRYPT</i>	<i>under 356</i>			<i>7</i>	<i>Y</i>	<i>p.b coffin</i>	
<i>DNA/B 479</i>	<i>Burial</i>	<i>CRYPT.</i>	<i>under 355+356</i>			<i>7</i>	<i>Y</i>	<i>p.b. coffin</i>	
<i>- 480</i>	<i>Burial</i>	<i>CRYPT</i>	<i>Bay 4</i>	<i>M/D/D</i>		<i>7</i>	<i>Y</i>	<i>intact infant pb</i>	
<i>- 481</i>	<i>Burial</i>	<i>CRYPT</i>		<i>M/D/D</i>		<i>7</i>	<i>Y</i>	<i>intact infant pb</i>	
<i>B 482</i>	<i>Burial</i>	<i>CRYPT</i>		<i>M/D/D</i>		<i>7</i>		<i>p.b coffin.</i>	
<i>483</i>	<i>SKETCHED</i>	<i>S.C.</i>	<i>contains:-</i>	<i>DS</i>		<i>6.</i>		<i>VAULT.</i>	
<i>B 484</i>	<i>Burial</i>	<i>S.C.</i>	<i>in vault 483 under 489 of 485</i>	<i>M/D</i>		<i>6</i>		<i>wood coffin</i>	
<i>B 485</i>	<i>Burial</i>	<i>S.C.</i>	<i>U/484 O/490</i>	<i>M/D</i>		<i>6</i>		<i>p.b. coffin</i>	
<i>B 486</i>	<i>Burial</i>	<i>S.C.</i>	<i>O/487</i>	<i>M/D</i>		<i>6</i>		<i>wood coffin</i>	
<i>B 487</i>	<i>Burial</i>	<i>S.C.</i>	<i>U/486 O/488</i>	<i>M/D</i>		<i>6</i>		<i>wood coffin</i>	
<i>DNA/B 488</i>	<i>Burial</i>	<i>S.C.</i>	<i>U/487</i>	<i>M/D</i>		<i>6</i>	<i>Y</i>	<i>p.b. coffin (B)</i>	
<i>B 489</i>	<i>Burial</i>	<i>S.C.</i>	<i>O/484</i>	<i>M/D</i>		<i>6</i>		<i>wood coffin</i>	
<i>B 490</i>	<i>Burial</i>	<i>S.C.</i>	<i>U/485 O/491</i>	<i>M/D</i>		<i>6</i>		<i>p.b. coffin</i>	
<i>DNA/B 491</i>	<i>Burial</i>	<i>S.C.</i>	<i>U/490</i>	<i>M/D</i>		<i>6</i>	<i>Y</i>	<i>p.b. coffin</i>	
<i>DNA/B 492</i>	<i>Burial</i>	<i>CRYPT</i>	<i>in Bay 3</i>	<i>M/D/D</i>		<i>7</i>	<i>Y</i>	<i>p.b coffin</i>	
<i>- 493</i>	<i>Burial</i>	<i>CRYPT</i>	<i>in vault 551</i>	<i>M/D/D</i>		<i>7</i>	<i>Y</i>	<i>intact infant p.b.</i>	
<i>DNA/B 494</i>	<i>Burial</i>	<i>CRYPT</i>	<i>U/</i>	<i>M/D/D</i>		<i>7</i>	<i>Y</i>	<i>p.b. coffin</i>	
<i>DNA/B 495</i>	<i>Burial</i>	<i>CRYPT</i>	<i>U/</i>	<i>M/D/D</i>		<i>7</i>	<i>Y</i>	<i>p.b coffin</i>	
<i>DNA/B 496</i>	<i>MOD STRUCTURE</i>	<i>S.C.</i>				<i>6</i>		<i>VAULT</i>	
<i>DNA/B 497</i>	<i>BURIAL</i>	<i>SC</i>	<i>in vault 496</i>	<i>M/D</i>		<i>6</i>	<i>Y</i>	<i>p.b. coffin</i>	

dp

SITE OLR00	COFFIN RECORD SHEET	CONTEXT NO. 365
Trench:	Additional sheets: YES X1.	Treatment: Bones collected (upper body).
Site sub-div: N.C.	Grave fills	
Plan no: 3.	Grave cut:	Finds ✓ None
Section no:	Skeleton: 365.	Breastplate Frags. Grip
Co-ordinates:	Matrix location:	Hinge Bracket
Levels	Preservation: Truncated at waist. upper body retrieved.	Fixing nails Shroud pins
Slide No.	Neg No:	Fabric Other finds

Description E-W skeleton - truncated at waist - upper body retrieved.

Discussion Coffin wood seen. Some furniture found.

Shape, dimensions and distinguishing characteristics

LID

HEAD

BASE

Recorder: SR	Date: 25/9	Initials:
-----------------	---------------	-----------

Coffin Recording Sheet

Site Code

Context

02200

365

Outer Coffin

Sample Ret.

Recording Date 5/12/00

Associated Numbers

Condition

Dep. Plate *Poss.*

Legible *NO.*

Inscription *1 x fe frag, poss from dep. plate.*

Fabric lead ormolou brass tin plated pewter gilt tin
 iron silvered tin enamelled other Sample Ret.

Shape of dep. plate

square rectangle shield tapered lozenge
 cartouche oval other

Upholstery

colour shoddy velvet other Sample Ret.

Construction

butt joint mitred pitched other

Grip plate

Fabric = ormolou brass tin plated pewter gilt tin
frags on rev. of grip.
 iron silvered tin enamelled other Sample Ret.

Grip

Fabric = ormolou brass iron *x1* Sample Ret.

Design

swag of rose horseshoe cherub's head *20* plain

other

Grip bolts

Corner bolts Type = gilt brass brass iron

other Sample Ret.

Lid motifs

other Sample Ret.

Escutcheons

other Sample Ret.

Upholstery nails

brass gilt brass silvered brass iron enamelled

other Sample Ret.

Fixings

panel nails screws hinges lace Sample Ret.

Timber type

..... Sample Ret.

Interpretation / Comments

.....

db.

SITE 01200	COFFIN RECORD SHEET	CONTEXT NO. 366
Trench:	Additional sheets: YES x1.	Treatment: Bones collected.
Site sub-div: NC.	Grave fills	
Plan no: 3	Grave cut:	Finds None
Section no:	Skeleton: 366.	Breastplate Grip
Co-ordinates:	Matrix location: under 331.	Hinge Bracket
Levels	Preservation:	Fixing nails Shroud pins
Slide No.	Neg No:	Fabric Other finds

Description

Extra bones:

Discussion

sacrum
 Right radius + ulna
 Right patella
 Right 2nd + 3rd MC
 Right scaphoid, hamate, lunate + capitate.
 All adult & from SK 319

Shape, dimensions and distinguishing characteristics

LID

HEAD

BASE

Recorder: DS	Date: 25/9	Initials:
--------------	------------	-----------

Outer Coffin

Sample Ret.

Site Code

Context

OH200

366

Recording Date 4/12/00

Associated Numbers

Condition

Dep. Plate

Legible

Inscription

Fabric lead ormolou brass tin plated pewter gilt tin
 iron silvered tin enamelled other Sample Ret.

Shape of dep. plate

square rectangle shield tapered lozenge
 cartouche oval other

Upholstery

colour shoddy velvet other Sample Ret.

Construction

butt joint mitred pitched other

Grip plate

Fabric = ormolou brass tin plated pewter gilt tin
 iron silvered tin enamelled other Sample Ret.
Frags on rev of grip - ~~cartouche~~ cartouche, but not enough to id.

Grip

Fabric = ormolou brass iron ^{X3} _{20's} Sample Ret.

Design

swag of rose horseshoe cherub's head plain
 other

Grip bolts

Corner bolts Type = gilt brass brass iron

other Sample Ret.

Lid motifs

other Sample Ret.

Escutcheons

other Sample Ret.

Upholstery nails

brass gilt brass silvered brass iron enamelled

other Sample Ret.

Fixings

panel nails screws hinges lace Sample Ret.

Timber type

Sample Ret.

Interpretation / Comments

.....

db.

SITE OLR00	COFFIN RECORD SHEET	CONTEXT NO. 367
Trench:	Additional sheets: YES x 1	Treatment: Bones collected
Site sub-div: NC	Grave fills	
Plan no: 3	Grave cut:	Finds None
Section no:	Skeleton: 367	Breastplate Grip
Co-ordinates:	Matrix location: under 319	Hinge Bracket
Levels	Preservation:	Fixing nails Shroud pins
Slide No.	Neg No:	Fabric Other finds

Description

Discussion

Shape, dimensions and distinguishing characteristics

Poss mixing with 366 / 319

LID

A second burial rep. by L + R CLAVICLES (MEDIAL END FUSE)

HEAD

ALSO ? M2 - roots in completely fused

Also cervical vertebral elements from 2 individuals & Thoracic vertebral elements from 2 individuals.

BASE

Recorder: DS	Date: 25/9	Initials:
-----------------	---------------	-----------

Site Code

Context

OK100

367

Outer Coffin

Sample Ret.

Recording Date *11/12/00*

Associated Numbers

Condition

Dep. Plate

Legible

Inscription

Fabric lead ormolou brass tin plated pewter gilt tin
 iron silvered tin enamelled other Sample Ret.

Shape of dep. plate

square rectangle shield tapered lozenge
 cartouche oval other

Upholstery

colour shoddy velvet other Sample Ret.

Construction

butt joint mitred pitched other

Grip plate

Fabric = ormolou brass tin plated pewter gilt tin
 iron *Reason KEV of grip, unid.* silvered tin enamelled other Sample Ret.

Grip

Fabric = ormolou brass iron *x1* Sample Ret.

Design

swag of rose horseshoe cherub's head plain

other

Grip bolts

Corner bolts Type = gilt brass brass iron

other Sample Ret.

Lid motifs

other

Sample Ret.

Escutcheons

other

Sample Ret.

Upholstery

studs *nails* brass gilt brass silvered brass iron *x1 piece* enamelled

other *oo = 3 studs in total.* Sample Ret.

Fixings

 panel nails screws hinges lace Sample Ret.

Timber type

..... Sample Ret.

Interpretation / Comments

.....

db

SITE		COFFIN RECORD SHEET		CONTEXT NO.	
OL200		Additional sheets: 4E5X1.		368	
Trench:		Grave fills		Treatment: BONES COLLECTED	
Site sub-div: NL		Grave cut:		Finds ✓	
Plan no: 3		Skeleton: 368		None	
Section no:		Matrix location: 318		Breastplate	
Co-ordinates:		368 UNDER 318		Grip ✓	
Levels		Preservation: FAIR		Hinge	
Slide No.		Neg No:		Bracket	
				Fixing nails	
				Shroud pins	
				Fabric	
				Other finds	
Description					
G-W SKELETON					
COFFIN WOOD JGWN					
Discussion					
Shape, dimensions and distinguishing characteristics					
LID					
HEAD					
BASE					
Recorder:		Date:		Initials:	

Coffin Recording Sheet

Outer Coffin

Sample Ret.

Site Code

Context

Recording Date 29/11/00

OR00

368

Associated Numbers

Condition

Dep. Plate

Legible

Inscription

Fabric lead ormolou brass tin plated pewter gilt tin
 iron silvered tin enamelled other Sample Ret.

Shape of dep. plate

square rectangle shield tapered lozenge
 cartouche oval other

Upholstery

colour shoddy velvet other Sample Ret.

Construction

butt joint mitred pitched other

Grip plate

Fabric = ormolou brass tin plated pewter gilt tin
keys on rev. of grip.

iron silvered tin enamelled other Sample Ret.

Grip

Fabric = ormolou brass iron *x2* Sample Ret.

Design

swag of rose horseshoe cherub's head plain

other *conc. ①'s*

Grip bolts

Corner bolts Type = gilt brass brass iron

other Sample Ret.

Lid motifs

other

Sample Ret.

Escutcheons

other

Sample Ret.

Upholstery nails

brass gilt brass silvered brass iron enamelled

other Sample Ret.

Fixings

panel nails screws hinges lace Sample Ret.

Timber type

Sample Ret.

Interpretation / Comments

.....

SITE		COFFIN RECORD SHEET		CONTEXT NO.	
CH 2500				369	
Trench:		Additional sheets:		Treatment:	
Site sub-div: NC		Grave fills		BONES COLLECTED	
Plan no: 3		Grave cut:		Finds None	
Section no:		Skeleton: 369		Breastplate Grip	
Co-ordinates:		Matrix location:		Hinge Bracket	
Levels		Preservation: Poor		Fixing nails Shroud pins	
Slide No.		Neg No:		Fabric Other finds	
Description Truncated down left side no L arm or leg. Coff: wood seen but no fittings					
Discussion					
Shape, dimensions and distinguishing characteristics					
LID					
HEAD					
BASE					
Recorder: JH		Date: 26/7/02		Initials:	

R. Leg needs collecting

db

SITE OLR00	COFFIN RECORD SHEET	CONTEXT NO. 370
Trench:	Additional sheets: YES x2.	Treatment:
Site sub-div: NC	Grave fills	Bones (collected)
Plan no: 3	Grave cut:	Finds None
Section no:	Skeleton: 370	Breastplate Grip
Co-ordinates:	Matrix location: Over 371	Hinge Bracket
Levels	Preservation:	Fixing nails Shroud pins
Slide No.	Neg No:	Fabric Other finds
Description Lower legs missing. Large adult		
Discussion		
Shape, dimensions and distinguishing characteristics		
LID		
HEAD		
BASE		
Recorder:	Date:	Initials:

Outer Coffin

Sample Ret.

Site Code

Context

OL200

370

Recording Date 29/11/00

Associated Numbers

Condition 1

Dep. Plate

Legible No

Inscription ✓ 2 x Pb frags, when viewed from REV. traces of lettering can be seen. "Died" see following sheet.

Fabric lead ormolou brass tin plated pewter gilt tin
 iron silvered tin enamelled other Sample Ret.

Shape of dep. plate

square rectangle shield tapered lozenge
 cartouche oval other

Upholstery

colour shoddy velvet other Sample Ret.

Construction butt joint mitred pitched other

Grip plate Fabric = ormolou brass tin plated pewter gilt tin
 iron silvered tin enamelled other Sample Ret.

Grip Fabric = ormolou brass iron Sample Ret.

Design swag of rose horseshoe cherub's head plain
 other

Grip bolts **Corner bolts** **Type =** gilt brass brass iron
 other Sample Ret.

Lid motifs other Sample Ret.

Escutcheons other Sample Ret.

Upholstery nails brass gilt brass silvered brass iron enamelled
 other Sample Ret.

Fixings panel nails screws hinges lace Sample Ret.

Timber type Sample Ret.

Interpretation / Comments

.....

OLROD

370

cont.

Scale 1:1

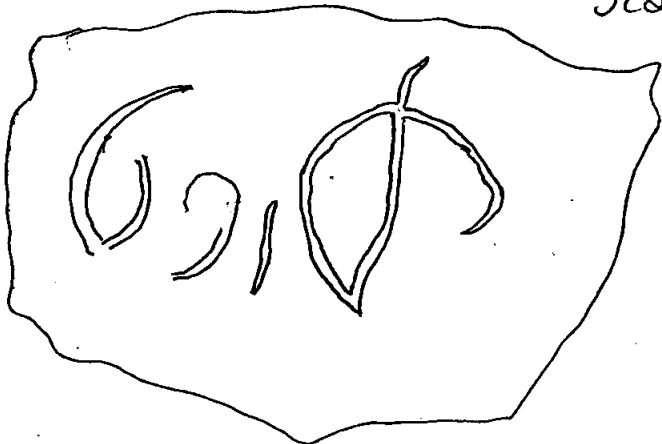

Scale 1:1.

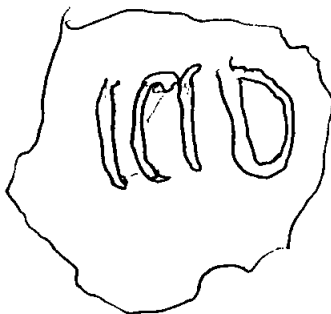

db.

SITE AL200		COFFIN RECORD SHEET	CONTEXT NO: 371
Trench:	Additional sheets: YES x 1	Treatment: Bones collected	
Site sub-div: NC	Grave fills		
Plan no: 3	Grave cut:	Finds None	
Section no:	Skeleton: 371	Breastplate Grip	
Co-ordinates:	Matrix location: below 370	Hinge Bracket	
Levels	Preservation:	Fixing nails Shroud pins	
Slide No.	Neg No:	Fabric Other finds	
Description Burial E-W Young adult/Juvenile			
Discussion			
Shape, dimensions and distinguishing characteristics			
LID			
HEAD			
BASE			
Recorder: A. H. U. A. Norton	Date: 26.9.	Initials:	

Coffin Recording Sheet

Site Code

Context

Outer Coffin

Sample Ret.

OL600

371

Recording Date 5/12/00

Associated Numbers

Condition

Dep. Plate

Legible

Inscription

Fabric lead ormolou brass tin plated pewter gilt tin
 iron silvered tin enamelled other Sample Ret.

Shape of dep. plate

square rectangle shield tapered lozenge
 cartouche oval other

Upholstery

colour shoddy velvet other Sample Ret.

Construction

butt joint mitred pitched other

Grip plate Fabric = ormolou brass tin plated pewter gilt tin
 iron silvered tin enamelled other Sample Ret.
Flags on lev of grip-wood.

Grip Fabric = ormolou brass iron x2 Sample Ret.

Design swag of rose horseshoe cherub's head (3b) plain

other

Grip bolts Corner bolts Type = gilt brass brass iron

other Sample Ret.

Lid motifs other Sample Ret.

Escutcheons other Sample Ret.

Upholstery nails brass gilt brass silvered brass iron enamelled

other Sample Ret.

Fixings panel nails screws hinges lace Sample Ret.

Timber type Sample Ret.

Interpretation / Comments

.....

SITE		COFFIN RECORD SHEET		CONTEXT NO. 372	
Trench:	AL 200	Additional sheets:		Treatment:	Bones Collected
Site sub-div:	NC	Grave fills		Finds	None
Plan no:	3	Grave cut:		Breastplate	
Section no:		Skeleton:	372	Grip	
Co-ordinates:		Matrix location:		Hinge	
Levels		Preservation:	GOOD	Bracket	
Slide No.		Neg No:		Fixing nails	
				Shroud pins	
				Fabric	
				Other finds	
Description					
ONLY 1. LEG & FEET V. TRUNCATED					
Discussion					
Shape, dimensions and distinguishing characteristics					
LID					
HEAD					
BASE					
Recorder:		Date:		Initials:	

db

SITE OL200		COFFIN RECORD SHEET	CONTEXT NO. 373
Trench:		Additional sheets: YES x1.	Treatment: BONES COLLECTED
Site sub-div: NC		Grave fills	
Plan no: 3		Grave cut:	Finds None
Section no:		Skeleton: 373	Breastplate Grip
Co-ordinates:		Matrix location: over 374	Hinge Bracket
Levels		Preservation: Poor	Fixing nails Shroud pins
Slide No.		Neg No:	Fabric Other finds
Description DECAYED ADULT OVER Pb coffin no head spine ribs -			
Discussion			
Shape, dimensions and distinguishing characteristics			
LID			
HEAD			
BASE			
Recorder:		Date:	Initials:

Outer Coffin

Sample Ret.

Site Code

Context

Recording Date 28/11/00

06200

373

Associated Numbers

Condition

Dep. Plate

Legible

Inscription

Fabric lead ormolou brass tin plated pewter gilt tin
 iron silvered tin enamelled other Sample Ret.

Shape of dep. plate

square rectangle shield tapered lozenge
 cartouche oval other

Upholstery

colour shoddy velvet other Sample Ret.

Construction

butt joint mitred pitched other

Grip plate

Fabric = ormolou brass tin plated pewter gilt tin
 iron silvered tin enamelled other Sample Ret.

fibres on rev of grip - unid.

Grip

Fabric = ormolou brass iron 4 x 5 Sample Ret.

Design

swag of rose horseshoe cherub's head 45 plain

other

Grip bolts

Corner bolts Type = gilt brass brass iron

other Sample Ret.

Lid motifs

other Sample Ret.

Escutcheons

other Sample Ret.

Upholstery nails

brass gilt brass silvered brass iron enamelled

other Sample Ret.

Fixings

panel nails screws hinges lace Sample Ret.

Timber type

Sample Ret.

Interpretation / Comments

.....

SITE		COFFIN RECORD SHEET		CONTEXT NO.	
04200				374	
Trench:		Additional sheets:		Treatment:	
Site sub-div: NC		Grave fills		BONES COLLECTED	
Plan no: 3		Grave cut:		Finds	
Section no:		Skeleton: 374		None	
Co-ordinates:		Matrix location: UNDER 373		Breastplate	
Levels		Preservation: V. GOOD		Grip ✓	
Slide No.		Neg No:		Hinge	
				Bracket	
				Fixing nails	
				Shroud pins	
				Fabric ✓	
				Other finds LEAD COFFIN	
Description					
V. Old arthritic man? in Lead coffin					
Discussion					
Coffin 2m long but squashed in at sides, very decayed.					
Shape, dimensions and distinguishing characteristics					
LID					
HEAD					
BASE					
Recorder: A. Nelson		Date: 26.9.		Initials:	

SITE	COFFIN RECORD SHEET	CONTEXT NO.
OLR 00		375
Trench:	Additional sheets:	Treatment: Bones collected.
Site sub-div: NC	Grave fills —	
Plan no: 3	Grave cut: —	Finds
Section no:	Skeleton: 375	None
Co-ordinates:	Matrix location: o/lcs 376	Breastplate
Levels	Preservation: Good.	Grip
Slide No.	Neg No:	Hinge
Description	E-W. Directly overlying 376, possible mixing. keys Some legs missing - possibly truncated by 376?	Bracket
Discussion		Fixing nails
Shape, dimensions and distinguishing characteristics		Shroud pins
LID		Fabric
HEAD		Other finds
BASE		
Recorder: D. Hall	Date: 26.9.	Initials:

db.

SITE <i>OLR 50</i>	COFFIN RECORD SHEET	CONTEXT NO. <i>376</i>
Trench:	Additional sheets: <i>YES x 1</i>	Treatment: <i>Bones collected.</i>
Site sub-div: <i>NC</i>	Grave fills: <i>-</i>	
Plan no: <i>3</i>	Grave cut: <i>-</i>	Finds None
Section no:	Skeleton: <i>376</i>	Breastplate Grip
Co-ordinates:	Matrix location: <i>U/LOS 375</i>	Hinge Bracket
Levels	Preservation: <i>GOOD/FAIR.</i>	Fixing nails Shroud pins
Slide No.	Neg No:	Fabric Other finds

Description *E-W directly underlying 375 - poss. mixing.*

Discussion

<ul style="list-style-type: none"> <i>3 cervical</i> <i>2 Thoracic</i> <i>1 head of femur</i> <i>2 ischial tuberosities</i> <i>1 capitata; right</i> 	} likely to be from <i>375</i>
---	--------------------------------

Shape, dimensions and distinguishing characteristics

LID

HEAD

BASE

Recorder: <i>D. How</i>	Date: <i>26.9.</i>	Initials:
-------------------------	--------------------	-----------

Coffin Recording Sheet

Site Code

Context

Outer Coffin

Sample Ret.

OR 200

376

Recording Date 6/12/00

Associated Numbers

Condition

Dep. Plate

Legible

Inscription

Fabric lead ormolou brass tin plated pewter gilt tin
 iron silvered tin enamelled other Sample Ret.

Shape of dep. plate

square rectangle shield tapered lozenge
 cartouche oval other

Upholstery

colour shoddy velvet other Sample Ret.

Construction

butt joint mitred pitched other

Grip plate Fabric = ormolou brass tin plated pewter gilt tin
 iron *Feeds on rev of grip-wood.* silvered tin enamelled other Sample Ret.

Grip Fabric = ormolou brass iron *x5* Sample Ret.

Design swag of rose horseshoe cherub's head *(36)* plain
 other

Grip bolts Corner bolts Type = gilt brass brass iron
 other Sample Ret.

Lid motifs other Sample Ret.

Escutcheons other Sample Ret.

Upholstery nails brass gilt brass silvered brass iron enamelled
 other Sample Ret.

Fixings panel nails screws hinges lace Sample Ret.

Timber type Sample Ret.

Interpretation / Comments

.....

db.

SITE <i>OLR 00</i>		COFFIN RECORD SHEET	CONTEXT NO. <i>377</i>
Trench:	Additional sheets: <i>YES X1</i>		Treatment: <i>Bones collected.</i>
Site sub-div: <i>NC</i>	Grave fills <i>-</i>		
Plan no: <i>3</i>	Grave cut: <i>-</i>		Finds None
Section no:	Skeleton: <i>377</i>		Breastplate Grip
Co-ordinates:	Matrix location: <i>o/lces 378</i>		Hinge Bracket
Levels	Preservation: <i>Fair.</i>		Fixing nails Shroud pins
Slide No.	Neg No:		Fabric Other finds
Description <i>E-W. Child burial some poss. mixing with 378 + 381</i>			
Discussion			
Shape, dimensions and distinguishing characteristics			
LID			
HEAD			
BASE			
Recorder: <i>D. Hall</i>	Date: <i>27.9.</i>		Initials:

Site Code

Context

Outer Coffin

Sample Ret.

02200

377

Recording Date 5/12/00

Associated Numbers

Condition

Dep. Plate

Legible

Inscription

Fabric lead ormolou brass tin plated pewter gilt tin
 iron silvered tin enamelled other Sample Ret.

Shape of dep. plate

square rectangle shield tapered lozenge
 cartouche oval other

Upholstery

colour shoddy velvet other Sample Ret.

Construction

butt joint mitred pitched other

Grip plate

Fabric = ormolou brass tin plated pewter gilt tin
fits on rev. of grip-wood
 iron silvered tin enamelled other Sample Ret.

Grip

Fabric = ormolou brass iron *x5* Sample Ret.

Design

swag of rose horseshoe cherub's head plain

other *4x ←→ 0.12 ↓ -0.05 1x → 0.09 ↓ 0.04*

Grip bolts

Corner bolts Type = gilt brass brass iron

other Sample Ret.

Lid motifs

other Sample Ret.

Escutcheons

other Sample Ret.

Upholstery nails

brass gilt brass silvered brass iron enamelled

other Sample Ret.

Fixings

panel nails screws hinges lace Sample Ret.

Timber type

Sample Ret.

Interpretation / Comments

.....

db

SITE OLR 50		COFFIN RECORD SHEET	CONTEXT NO. 378
Trench:	Additional sheets: YEDX1	Treatment: Bones collected.	
Site sub-div: NC	Grave fills: /		
Plan no: 3	Grave cut: /	Finds None	
Section no:	Skeleton: 378	Breastplate Grip	
Co-ordinates:	Matrix location: o/wes. 377 o/wes 381	Hinge Bracket	
Levels	Preservation: Fair.	Fixing nails Shroud pins	
Slide No.	Neg No:	Fabric Other finds:	
Description E-W adult burial poss. mixing with 381			
Discussion			
Shape, dimensions and distinguishing characteristics			
LID	Anterior portion of a mandible also present Right C, Pm1, Pm2 & M1 also present Aged between 18-24. Possibly part of 381?		
HEAD			
BASE			
Recorder: D. Hall	Date: 27.9.	Initials:	

Site Code

Context

Outer Coffin

Sample Ret.

6LR00

378

Recording Date 5/12/00

Associated Numbers

Condition

Dep. Plate

Legible

Inscription

Fabric lead ormolou brass tin plated pewter gilt tin
 iron silvered tin enamelled other Sample Ret.

Shape of dep. plate

square rectangle shield tapered lozenge
 cartouche oval other

Upholstery

colour shoddy velvet other Sample Ret.

Construction

butt joint mitred pitched other

Grip plate Fabric = ormolou brass tin plated pewter gilt tin
 iron silvered tin enamelled other *on rev of grip - poss. cherub (single) beneath poss cartouche. - unid.* Sample Ret.

Grip Fabric = ormolou brass iron X6 Sample Ret.

Design swag of rose horseshoe cherub's head ④'s plain
 other

Grip bolts Corner bolts Type = gilt brass brass iron
 other Sample Ret.

Lid motifs other Sample Ret.

Escutcheons other Sample Ret.

Upholstery nails brass gilt brass silvered brass iron enamelled
 other Sample Ret.

Fixings panel nails screws hinges lace Sample Ret.

Timber type Sample Ret.

Interpretation / Comments

.....

db.

SITE OLR 00		COFFIN RECORD SHEET		CONTEXT NO. 379	
Trench:		Additional sheets: 465x1		Treatment: Bones collected.	
Site sub-div: NC		Grave fills -			
Plan no: 3		Grave cut: -		Finds None	
Section no:		Skeleton: 379		Breastplate Grip	
Co-ordinates:		Matrix location: v/wes 382 o/wes 380		Hinge Bracket	
Levels		Preservation: Good.		Fixing nails Shroud pins	
Slide No.		Neg No:		Fabric Other finds	
Description E-W. Adult burial. Some chance of mixing with 380.					
Discussion					
Shape, dimensions and distinguishing characteristics					
LID					
HEAD					
BASE					
Recorder: D. Hall		Date: 27-9.		Initials:	

Coffin Recording Sheet

Site Code

Context

Outer Coffin

Sample Ret.

Orloo

379

Recording Date *20/11*

Associated Numbers

Condition

Dep. Plate

Legible

Inscription

Fabric lead ormolou brass tin plated pewter gilt tin
 iron silvered tin enamelled other Sample Ret.

Shape of dep. plate

square rectangle shield tapered lozenge
 cartouche oval other

Upholstery

colour shoddy velvet other Sample Ret.

Construction

butt joint mitred pitched other

Grip plate Fabric = ormolou brass tin plated pewter gilt tin
 iron silvered tin enamelled other Sample Ret.

frogs on rev of grip - unid.

Grip Fabric = ormolou brass iron x 3 Sample Ret.

Design

swag of rose horseshoe cherub's head plain

other *1 x 0.13 ←→ / ↓ 0.04 ~ 2 x 0.09 ~ / ↓ 0.03* *228a type.*

Grip bolts

Corner bolts Type = gilt brass brass iron

other Sample Ret.

Lid motifs

other Sample Ret.

Escutcheons

other Sample Ret.

Upholstery

studs

brass gilt brass silvered brass iron enamelled

other *1 x piece - 0.00 = 6 studs in total.* Sample Ret.

Fixings

panel nails screws hinges lace Sample Ret.

Timber type

Sample Ret.

Interpretation / Comments

.....

SITE	COFFIN RECORD SHEET	CONTEXT NO.
OLR 050	Additional sheets: YES x1.	380 Treatment: Bones collected.
Site sub-div: NC	Grave fills —	
Plan no: 3	Grave cut: —	Finds None
Section no:	Skeleton: 380	Breastplate Grip
Co-ordinates:	Matrix location: u/kes 379	Hinge Bracket
Levels	Preservation: Good.	Firing nails Shroud pins
Slide No.	Neg No:	Fabric Other finds
Description E-W. adult burial. Poss. mixing with 379.		
Discussion		
Shape, dimensions and distinguishing characteristics		
LID		
HEAD		
BASE		
Recorder: D. Hall	Date: 27.9.	Initials:

Coffin Recording Sheet

Site Code

Context

04200

380

Outer Coffin

Sample Ret.

Recording Date 28/11/00

Associated Numbers

Condition

Dep. Plate

Legible

Inscription

Fabric lead ormolou brass tin plated pewter gilt tin
 iron silvered tin enamelled other Sample Ret.

Shape of dep. plate

square rectangle shield tapered lozenge
 cartouche oval other

Upholstery

colour shoddy velvet other Sample Ret.

Construction

butt joint mitred pitched other

Grip plate

Fabric = ormolou brass tin plated pewter gilt tin
Feeds all rev of grips.
 iron silvered tin enamelled other Sample Ret.

Grip

Fabric = ormolou brass iron XI Sample Ret.

Design

swag of rose horseshoe cherub's head plain

other *1x 228 b.*

Grip bolts

Corner bolts Type = gilt brass brass iron

other Sample Ret.

Lid motifs

other

Sample Ret.

Escutcheons

other

Sample Ret.

Upholstery nails

brass gilt brass silvered brass iron enamelled

other Sample Ret.

Fixings

panel nails screws hinges lace Sample Ret.

Timber type

Sample Ret.

Interpretation / Comments

.....

db

SITE OLR 50		COFFIN RECORD SHEET		CONTEXT NO. 381	
Trench:		Additional sheets: YES x 1		Treatment: Bones collected.	
Site sub-div: NL		Grave fills: -			
Plan no: 3		Grave cut: -		Finds None	
Section no:		Skeleton: 381		Breastplate Grip	
Co-ordinates:		Matrix location: o/wes 378. o/wes 384		Hinge Bracket	
Levels:		Preservation: Fair/good		Fixing nails Shroud pins	
Slide No.:		Neg No.:		Fabric Other finds	
Description E-W. Adult. Much collapsing occurred here, poss. mixing with 378					
Discussion					
Shape, dimensions and distinguishing characteristics					
LID					
HEAD					
BASE					
Recorder: D. Ham		Date: 27.9.		Initials:	

Outer Coffin

Sample Ret.

Site Code

Context

02600

381

Recording Date 1/12/00

Associated Numbers

Condition

Dep. Plate

Legible

Inscription

Fabric lead ormolou brass tin plated pewter gilt tin
 iron silvered tin enamelled other Sample Ret.

Shape of dep. plate

square rectangle shield tapered lozenge
 cartouche oval other

Upholstery

colour shoddy velvet other Sample Ret.

Construction

butt joint mitred pitched other

Grip plate

Fabric = ormolou brass tin plated pewter gilt tin
 iron silvered tin enamelled other Sample Ret.
fregs of cartouches on rev of gap + 2 dec fregs, unid-sec sheet.

Grip

Fabric = ormolou brass iron x2 Sample Ret.

Design

swag of rose horseshoe cherub's head plain

other *smallish 20's ↔ 0.11 ↑ 0.04*

Grip bolts

Corner bolts Type = gilt brass brass iron

other Sample Ret.

Lid motifs

other Sample Ret.

Escutcheons

other Sample Ret.

Upholstery

studs brass gilt brass silvered brass iron enamelled

other *∞ = 2 studs* Sample Ret.

Fixings

panel nails screws hinges lace Sample Ret.

Timber type

Sample Ret.

Interpretation / Comments

.....

SITE <i>OLR 00</i>		COFFIN RECORD SHEET	CONTEXT NO. <i>382</i>
Trench:	Additional sheets:	Treatment: <i>Bones collected.</i>	
Site sub-div: <i>NC</i>	Grave fills: <i>/</i>		
Plan no: <i>3</i>	Grave cut: <i>/</i>	Finds	
Section no:	Skeleton: <i>382</i>	None	
Co-ordinates:	Matrix location: <i>o/wes 379.</i>	Breastplate	
Levels	Preservation: Good <i>FAIR.</i>	Grip	
Slide No.	Neg No:	Hinge	
Description <i>E-W. child burial on top of 379, in public region.</i>		Bracket	
Discussion		Fixing nails	
Shape, dimensions and distinguishing characteristics		Shroud pins	
LID		Fabric	
HEAD		Other finds	
BASE			
Recorder: <i>D. Hill</i>	Date: <i>27.9.</i>	Initials:	

db.

SITE <i>OLR 00</i>		COFFIN RECORD SHEET		CONTEXT NO. <i>383</i>	
Trench:		Additional sheets: <i>YES x2</i>		Treatment: <i>Bones collected</i>	
Site sub-div: <i>N2</i>		Grave fills: <i>-</i>			
Plan no: <i>3</i>		Grave cut: <i>-</i>		Finds None	
Section no:		Skeleton: <i>383</i>		Breastplate Grip	
Co-ordinates:		Matrix location: <i>0/465 385</i> <i>0/465 388</i>		Hinge Bracket	
Levels:		Preservation: <i>GOOD</i>		Fixing nails Shroud pins	
Slide No.:		Neg No.:		Fabric Other finds	
Description <i>E-W adult burial.</i>					
Discussion					
Shape, dimensions and distinguishing characteristics					
LID					
HEAD					
BASE					
Recorder: <i>D. HAM</i>		Date: <i>27.9.</i>		Initials:	

Outer Coffin

Sample Ret.

Site Code

Context

OR200

383

Recording Date 5/12/00

Associated Numbers

Condition

Dep. Plate

Legible **NO**

Inscription

*Fe frags which prob. form part of dep plate. see sheet.
x many.*

Fabric lead ormolou brass tin plated pewter gilt tin
 iron silvered tin enamelled other Sample Ret.

Shape of dep. plate

square rectangle shield tapered lozenge
 cartouche oval other

Upholstery

colour shoddy velvet other *Beize* Sample Ret.

Construction butt joint mitred pitched other

Grip plate Fabric = ormolou brass tin plated pewter gilt tin
frags see sheet. iron silvered tin enamelled other Sample Ret.
Block

Grip Fabric = ormolou brass iron *X 4* Sample Ret.

Design swag of rose horseshoe cherub's head *4's* plain
 other

Grip bolts **Corner bolts** Type = gilt brass brass iron
 other Sample Ret.

Lid motifs other Sample Ret.

Escutcheons other Sample Ret.

Upholstery *studs* brass gilt brass silvered brass iron *Block* enamelled
nails
 other *1 x 0000 / 1 x 0000000 / 1 x 000 = total 15 studs.* Sample Ret.

Fixings panel nails screws hinges lace Sample Ret.

Timber type Sample Ret.

Interpretation / Comments

.....

.....

grip plate frag: black enameled
tin pewter.

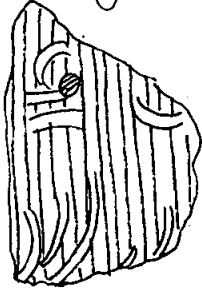

Scale 1:1.

dep? plate frags: Fe.

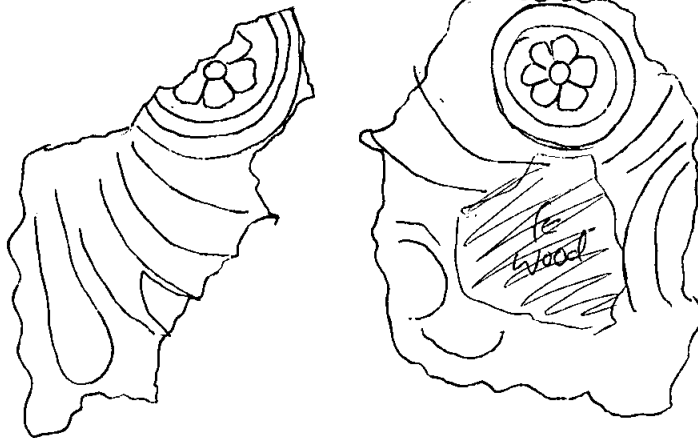

Scale 1:1.

SITE		COFFIN RECORD SHEET		CONTEXT NO.	
OLROU				384	
Trench:		Additional sheets:		Treatment:	
Site sub-div: NC		Grave fills		BONES COLLECTED	
Plan no: 3		Grave cut:		Finds	
Section no:		Skeleton: 384		None	
Co-ordinates:		Matrix location: 381 384 389		Breastplate	
Levels		Preservation: Good		Grip	
Slide No.		Neg No:		Hinge	
				Bracket	
				Fixing nails	
				Shroud pins	
				Fabric	
				Other finds	
Description					
One of many bodies in family group. Ⓢ					
Mixed with 381, 387, 390					
Discussion					
Mixed w.b.					
6-w Adult					
Shape, dimensions and distinguishing characteristics					
LID					
HEAD					
BASE					
Recorder:		Date:		Initials:	

210

SITE OLR00		COFFIN RECORD SHEET		CONTEXT NO. 385	
Trench:		Additional sheets: YES x 1.		Treatment:	
Site sub-div: NC		Grave fills		BONES COLLECTED	
Plan no: 3		Grave cut:		Finds	
Section no:		Skeleton: 385		None	
Co-ordinates:		Matrix location: U/465 383 UNCLEAR WITH 388		Breastplate	
Levels		Preservation: GOOD		Grip	
Slide No.		Neg No:		Hinge	
Description		IN LEAD COFFIN E-W ADULT		Bracket	
Discussion		MACHINED OUT. J. DEEP.		Fixing nails	
Shape, dimensions and distinguishing characteristics				Shroud pins	
LID				Fabric	
HEAD				Other finds	
BASE					
Recorder:		Date:		Initials:	

Coffin Recording Sheet

Site Code

Context

Outer Coffin

Sample Ret.

02200

385

Recording Date 6/12/00

Associated Numbers

Condition 1

Dep. Plate

Legible NO

Inscription *unidentifiable.*

Fabric lead ormolou brass tin plated pewter gilt tin
 iron silvered tin enamelled other Sample Ret.

Shape of dep. plate

square rectangle shield tapered lozenge
 cartouche oval other

Upholstery

colour shoddy velvet other Sample Ret.

Construction

butt joint mitred pitched other

Grip plate Fabric = ormolou brass tin plated pewter gilt tin
 iron silvered tin enamelled other Sample Ret.

Grip Fabric = ormolou brass iron Sample Ret.

Design swag of rose horseshoe cherub's head plain
 other

Grip bolts Corner bolts Type = gilt brass brass iron
 other Sample Ret.

Lid motifs other Sample Ret.

Escutcheons other Sample Ret.

Upholstery nails brass gilt brass silvered brass iron enamelled
 other Sample Ret.

Fixings panel nails screws hinges lace Sample Ret.

Timber type Sample Ret.

Interpretation / Comments

.....

SITE OLROD	COFFIN RECORD SHEET	CONTEXT NO. 386
Trench:	Additional sheets:	Treatment:
Site sub-div: NC	Grave fills	BONES COLLECTED
Plan no: 3	Grave cut:	Finds None
Section no:	Skeleton: 386	Breastplate Grip
Co-ordinates:	Matrix location: ON GALVIS 387	Hinge Bracket
Levels	Preservation: GOOD	Fixing nails Shroud pins
Slide No.	Neg No:	Fabric Other finds
<p>Description S-W ADULT FELL OUT OF N. SECTION</p> <p>Discussion</p>		
<p>Shape, dimensions and distinguishing characteristics</p> <p>LID</p> <p>HEAD</p> <p>BASE</p>		
Recorder:	Date:	Initials:

SITE		COFFIN RECORD SHEET		CONTEXT NO. 387	
Trench: 01200		Additional sheets:		Treatment:	
Site sub-div: NC		Grave fills:		BONES COLLECTED	
Plan no: 3		Grave cut:		Finds	
Section no:		Skeleton: 387		None	
Co-ordinates:		Matrix location: 0/465 386		Breastplate	
Levels:		Preservation: GOOD		Grip	
Slide No.:		Neg No.:		Hinge	
Description		6-W Adult (M) Fell out of N. section		Bracket	
Discussion				Fixing nails	
Shape, dimensions and distinguishing characteristics				Shroud pins	
LID				Fabric	
HEAD				Other finds	
BASE				:	
Recorder:		Date:		Initials:	

SITE		COFFIN RECORD SHEET		CONTEXT NO.	
OLROO				388	
Trench:		Additional sheets:		Treatment:	
Site sub-div: NC		Grave fills		BONES COLLECTED	
Plan no: 3		Grave cut:		Finds	
Section no:		Skeleton: 388		None	
Co-ordinates:		Matrix location: U/LISS 383 UNCLEAR WITH 385		Breastplate	
Levels		Preservation: GOOD		Grip	
Slide No.		Neg No:		Hinge	
Description				Bracket	
Discussion				Fixing nails	
Shape, dimensions and distinguishing characteristics				Shroud pins	
LID				Fabric	
HEAD				Other finds	
BASE					
Recorder:		Date:		Initials:	

db

SITE 02200	COFFIN RECORD SHEET	CONTEXT NO. 389
Trench:	Additional sheets VES x 1.	Treatment: BONES COLLECT
Site sub-div: NC	Grave fills	
Plan no: 3	Grave cut:	Finds None
Section no:	Skeleton: 389	Breastplate Grip
Co-ordinates:	Matrix location: 0/465 384 0/465 390	Hinge Bracket
Levels	Preservation: GOOD	Fixing nails Shroud pins
Slide No.	Neg No:	Fabric Other finds

Description
ADULT 6-W MIXED WITH 390, 384, 381
MACHINED OUT.

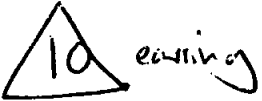
Discussion

Shape, dimensions and distinguishing characteristics

LID

HEAD

BASE

Recorder:	Date:	Initials:
-----------	-------	-----------

Coffin Recording Sheet

Site Code

Context

OLR00

389

Outer Coffin

Sample Ret.

Recording Date 1/12/00

Associated Numbers

Condition

Dep. Plate

Legible

Inscription

Fabric lead ormolou brass tin plated pewter gilt tin
 iron silvered tin enamelled other Sample Ret.

Shape of dep. plate

square rectangle shield tapered lozenge
 cartouche oval other

Upholstery

colour shoddy velvet other Sample Ret.

Construction

butt joint mitred pitched other

Grip plate Fabric = ormolou brass tin plated pewter gilt tin
 iron *resins on rev. of grip.* silvered tin enamelled other Sample Ret.

Grip Fabric = ormolou brass iron *x1* Sample Ret.

Design swag of rose horseshoe cherub's head plain
 other *Small ↔ 0.11 ↓ 0.04* ①

Grip bolts Corner bolts Type = gilt brass brass iron
 other Sample Ret.

Lid motifs other Sample Ret.

Escutcheons other Sample Ret.

Upholstery nails brass gilt brass silvered brass iron enamelled
 other Sample Ret.

Fixings panel nails screws hinges lace Sample Ret.

Timber type Sample Ret.

Interpretation / Comments

.....

db

SITE	02200	COFFIN RECORD SHEET	CONTEXT NO.	390
Trench:		Additional sheets:	YESX!	Treatment:
Site sub-div:	NC	Grave fills		BUNGS COLLECTED
Plan no:	3	Grave cut:		Finds
Section no:		Skeleton:	390	None
Co-ordinates:		Matrix location:	1/465 389	Breastplate
Levels		Preservation:	GOOD	Grip
Slide No.		Neg No:		Hinge
				Bracket
				Fixing nails
				Shroud pins
				Fabric
				Other finds

Description
 ANCI 6-W MACHINED OUT, MIXED WITH
 Discussion
 389, 394, 381

Shape, dimensions and distinguishing characteristics

LID

HEAD

BASE

Recorder:	Date:	Initials:
-----------	-------	-----------

Coffin Recording Sheet

Site Code

Context

Outer Coffin

Sample Ret.

AL00

390

Recording Date 4/12/00

Associated Numbers

Condition

Dep. Plate

Legible

Inscription

Fabric lead ormolou brass tin plated pewter gilt tin
 iron silvered tin enamelled other Sample Ret.

Shape of dep. plate

square rectangle shield tapered lozenge
 cartouche oval other

Upholstery

colour shoddy velvet other Sample Ret.

Construction

butt joint mitred pitched other

Grip plate **Fabric =** ormolou brass tin plated pewter gilt tin
 iron silvered tin enamelled other Sample Ret.

Grip **Fabric =** ormolou brass iron x1 Sample Ret.

Design swag of rose horseshoe cherub's head plain
 other *infant. (20) ← 0.11 ↓ 0.04.*

Grip bolts **Corner bolts** **Type =** gilt brass brass iron
 other Sample Ret.

Lid motifs other Sample Ret.

Escutcheons other Sample Ret.

Upholstery nails brass gilt brass silvered brass iron enamelled
 other Sample Ret.

Fixings panel nails screws hinges lace Sample Ret.

Timber type Sample Ret.

Interpretation / Comments

.....

db

SITE		COFFIN RECORD SHEET		CONTEXT NO. 391	
Trench: OLR00		Additional sheets: YESKI.		Treatment: BONES RECOVERED	
Site sub-div: NC		Grave fills			
Plan no: 3		Grave cut:		Finds None	
Section no:		Skeleton: 391		Breastplate Grip ✓	
Co-ordinates:		Matrix location: 391 392		Hinge Bracket	
Levels		Preservation: GOOD		Fixing nails Shroud pins	
Slide No.		Neg No:		Fabric Other finds	
Description 6-W Adult. 'CRANIOTOMY.'					
Discussion					
Shape, dimensions and distinguishing characteristics					
LID					
HEAD					
BASE					
Recorder:		Date:		Initials:	

Coffin Recording Sheet

Site Code

Context

07200

391

Outer Coffin

Sample Ret.

Recording Date 4/12/06

Associated Numbers

Condition

Dep. Plate

Legible

Inscription

Fabric lead ormolou brass tin plated pewter gilt tin
 iron silvered tin enamelled other Sample Ret.

Shape of dep. plate

square rectangle shield tapered lozenge
 cartouche oval other

Upholstery

colour shoddy velvet other Sample Ret.

Construction

butt joint mitred pitched other

Grip plate Fabric = ormolou brass tin plated pewter gilt tin
 iron silvered tin enamelled other Sample Ret.

Grip Fabric = ormolou brass iron ^{XA} Sample Ret.

Design swag of rose horseshoe cherub's head [⊕] _⊖ ^{+ x 1} ^{Ⓚ sm. plain}
 other _{↕ 0.10 ↔ 0.05}

Grip bolts Corner bolts Type = gilt brass brass iron
 other Sample Ret.

Lid motifs other

Escutcheons other

Upholstery nails brass gilt brass silvered brass iron enamelled
 other Sample Ret.

Fixings panel nails screws hinges lace Sample Ret.

Timber type

Interpretation / Comments

.....

SITE	COFFIN RECORD SHEET		CONTEXT NO.
OL/200	Additional sheets: 165 x 1.	392	
Trench:	Grave fills	Treatment: Bones Collected	
Site sub-div: NC	Grave cut:	Finds	
Plan no: 3	Skeleton: 392	None	
Section no:	Matrix location: UNDER 391 OVER 393	Breastplate ✓ Grip ✓	
Co-ordinates:	Preservation: Good.	Hinge Bracket	
Levels	Neg No:	Fixing nails Shroud pins	
Slide No.		Fabric Other finds	
Description: S-W Adult, head plate can't see name			
Discussion			
Shape, dimensions and distinguishing characteristics			
Recorder: Date: Initials:			

Site Code

Context

Outer Coffin

Sample Ret.

OLR00

392

Recording Date 20/11/00

Associated Numbers

Condition /

Dep. Plate

Legible ISH.

Inscription "Miss/Mary Sheppard? / Died 19th Sept^e? / 1808? / Aged 46 Years"

spltds. (82)

Fabric lead ormolou brass tin plated pewter gilt tin
 iron silvered tin enamelled other Sample Ret.

Shape of dep. plate

square rectangle shield tapered lozenge
 cartouche oval other

Upholstery

pieces of Swedish pitch.

colour shoddy velvet other Sample Ret.

Construction

butt joint mitred pitched other

Grip plate

Fabric = ormolou brass tin plated pewter gilt tin

iron silvered tin enamelled other Sample Ret.

keeps on ew. of grip

Grip

Fabric = ormolou brass iron x 7 Sample Ret.

Design

swag of rose horseshoe cherub's head + ix ① sm. plain

other *↓ 0.04 / 2 → 0.09*

Grip bolts

Corner bolts Type = gilt brass brass iron

other Sample Ret.

Lid motifs

other Sample Ret.

Escutcheons

other Sample Ret.

Upholstery nails

brass gilt brass silvered brass iron enamelled

other Sample Ret.

Fixings

panel nails screws hinges lace Sample Ret.

Timber type

Sample Ret.

Interpretation / Comments

.....

No

SITE 24200	COFFIN RECORD SHEET	CONTEXT NO. 373
Trench:	Additional sheets: YES x 2	Treatment:
Site sub-div: NC	Grave fills	BUNGS COLLECTED
Plan no: 3	Grave cut:	Finds
Section no:	Skeleton: 323	None
Co-ordinates:	Matrix location: 372 373	Breastplate ✓
Levels	Preservation: 374	Grip ✓
Slide No.	Neg No:	Hinge
		Bracket
		Fixing nails
		Shroud pins
		Fabric
		Other finds

Description
D.N.A d 6-w Adult

Discussion

Shape, dimensions and distinguishing characteristics

LID

HEAD

BASE

Recorder:	Date:	Initials:
-----------	-------	-----------

Site Code

Context

Outer Coffin

Sample Ret.

Ohloo

393

Recording Date 20/11/00

Associated Numbers

Condition 2

Dep. Plate

Legible LSH

Inscription "Mr/ John Sheppard/Died 2nd /1829?/In his 86^m? Yr"

Sptfals (82) w/ inscript. edges. see over.

Fabric lead ormolou brass tin plated pewter gilt tin
 iron silvered tin enamelled other Sample Ret.

black polished.

Shape of dep. plate

square rectangle shield tapered lozenge
 cartouche oval other

Upholstery

colour shoddy velvet other Sample Ret.

Construction

butt joint mitred pitched other

Grip plate Fabric = ormolou brass tin plated pewter gilt tin
 iron silvered tin enamelled other Sample Ret.

Grip Fabric = ormolou brass iron Sample Ret.

Design swag of rose horseshoe cherub's head plain
 other

Grip bolts Corner bolts Type = gilt brass brass iron
 other Sample Ret.

Lid motifs other Sample Ret.

Escutcheons other Sample Ret.

Upholstery studs brass gilt brass silvered brass iron enamelled
 other 1x 000 / 2x 0000 / 2x 00000 / 1x 000000 / 1x 0000000 = 30 studs in total. Sample Ret.

Fixings panel nails screws hinges lace Sample Ret.

Timber type Sample Ret.

Interpretation / Comments

.....

ab

SITE OLROO	COFFIN RECORD SHEET	CONTEXT NO. 394
Trench:	Additional sheets: YES x 1.	Treatment:
Site sub-div: NC	Grave fills	BONES COLLECTED
Plan no: 3	Grave cut:	Finds None
Section no:	Skeleton: 394	Breastplate Grip ✓
Co-ordinates:	Matrix location: 393 394 400	Hinge Bracket
Levels	Preservation: O.K. mouldy w/ 400	Fixing nails Shroud pins
Slide No.	Neg No:	Fabric Other finds
Description G-W ADULT		
Discussion		
Shape, dimensions and distinguishing characteristics		
LID		
HEAD		
BASE		
Recorder:	Date:	Initials:

Coffin Recording Sheet

Site Code

Context

Outer Coffin

Sample Ret.

OKR00

394

Recording Date 20/11/00

Associated Numbers

Condition 1

Dep. Plate

Legible 15H

Inscription "Mr / William H. ... ? / Died 23rd Nov^{er} 1761 / ... ?"
Unidentifiable - too oxidised.

Fabric lead ormolou brass tin plated pewter gilt tin
 iron silvered tin enamelled other Sample Ret.

Shape of dep. plate

square rectangle shield tapered lozenge
 cartouche oval other

Upholstery

colour shoddy velvet other Sample Ret.

Construction

butt joint mitred pitched other

Grip plate Fabric = ormolou brass tin plated pewter gilt tin
 iron silvered tin enamelled other Sample Ret.

Grip Fabric = ormolou brass iron 3 Sample Ret.

Design swag of rose horseshoe cherub's head (4's) plain
 other

Grip bolts Corner bolts Type = gilt brass brass iron
 other Sample Ret.

Lid motifs other Sample Ret.

Escutcheons other Sample Ret.

Upholstery ^{shuds} nails brass gilt brass silvered brass iron enamelled
 other *oooooo x 1 / ooooooo x 1 = 22 shuds in total.* Sample Ret.

Fixings panel nails screws hinges lace Sample Ret.

Timber type Sample Ret.

Interpretation / Comments

.....

db.

SITE OLR00		COFFIN RECORD SHEET		CONTEXT NO. 375	
Trench:		Additional sheets: YES x1		Treatment:	
Site sub-div: NC		Grave fills		BONE COLLECTED	
Plan no: 3		Grave cut:		Finds None	
Section no:		Skeleton: 375		Breastplate Grip ✓	
Co-ordinates:		Matrix location: 375 376		Hinge Bracket	
Levels		Preservation: GOOD		Fixing nails Shroud pins	
Slide No.		Neg No:		Fabric Other finds	
Description 6-W ADULT					
Discussion					
Shape, dimensions and distinguishing characteristics					
LID					
HEAD					
BASE					
Recorder:		Date:		Initials:	

Coffin Recording Sheet

Site Code

Context

Outer Coffin

Sample Ret.

OLR00

395

Recording Date 28/11

Associated Numbers

Condition

Dep. Plate

Legible

Inscription

Fabric lead ormolou brass tin plated pewter gilt tin
 iron silvered tin enamelled other Sample Ret.

Shape of dep. plate

square rectangle shield tapered lozenge
 cartouche oval other

Upholstery

colour shoddy velvet other Sample Ret.

Construction

butt joint mitred pitched other

Grip plate

Fabric = ormolou brass tin plated pewter gilt tin
 iron silvered tin enamelled other Sample Ret.
on rev of grip: bottom half of (13)

Grip

Fabric = ormolou brass iron x6 Sample Ret.

Design

swag of rose horseshoe cherub's head (20)'5 plain

other

Grip bolts

Corner bolts Type = gilt brass brass iron

other Sample Ret.

Lid motifs

other Sample Ret.

Escutcheons

other Sample Ret.

Upholstery nails

brass gilt brass silvered brass iron enamelled

other Sample Ret.

Fixings

panel nails screws hinges lace Sample Ret.

Timber type

..... Sample Ret.

Interpretation / Comments

.....

SITE <u>OROE</u>		COFFIN RECORD SHEET	CONTEXT NO. <u>396</u>
Trench:	Additional sheets:	Treatment: <u>BONE COLLECTED</u>	
Site sub-div: <u>NC</u>	Grave fills		
Plan no: <u>3</u>	Grave cut:	Finds None	
Section no:	Skeleton: <u>396</u>	Breastplate Grip <input checked="" type="checkbox"/>	
Co-ordinates:	Matrix location: <u>395</u> <u>396</u> <u>397</u>	Hinge Bracket	
Levels	Preservation: <u>GOOD</u>	Fixing nails Shroud pins	
Slide No.	Neg No:	Fabric Other finds :	
Description <u>6-w ADULT</u>			
Discussion			
Shape, dimensions and distinguishing characteristics			
LID			
HEAD			
BASE			
Recorder:	Date:	Initials:	

dk.

SITE 04200	COFFIN RECORD SHEET	CONTEXT NO. 397
Trench:	Additional sheets: YES x1	Treatment: BANKS COLLEGE
Site sub-div: NC	Grave fills	Finds None
Plan no: 3	Grave cut:	
Section no:	Skeleton: 397	Breastplate Grip
Co-ordinates:	Matrix location: 376 397	Hinge Bracket
Levels	Preservation:	Fixing nails Shroud pins
Slide No.	Neg No:	Fabric Other finds

Description
E-W ADULT IN LEAD COFFIN

Discussion

Shape, dimensions and distinguishing characteristics

LID

HEAD

BASE

Recorder: 	Date:	Initials:
---	-------	-----------

Coffin Recording Sheet

Site Code

Context

OLR00

397

Outer Coffin

Sample Ret.

Recording Date 29/11/00

Associated Numbers

Condition

Dep. Plate

Legible

Inscription

Fabric lead ormolou brass tin plated pewter gilt tin
 iron silvered tin enamelled other Sample Ret.

Shape of dep. plate

square rectangle shield tapered lozenge
 cartouche oval other

Upholstery

colour shoddy velvet other Boize Sample Ret.

Construction

butt joint mitred pitched other

Grip plate Fabric = ormolou brass tin plated pewter gilt tin
 iron silvered tin enamelled other Sample Ret.

Grip Fabric = ormolou brass iron x1 Sample Ret.

Design swag of rose horseshoe cherub's head plain
 other conc. (20)

Grip bolts **Corner bolts** **Type =** gilt brass brass iron
 other Sample Ret.

Lid motifs other Sample Ret.

Escutcheons other Sample Ret.

Upholstery ^{studs} ~~nails~~ brass gilt brass silvered brass iron enamelled
 other 2 pieces - 1x [drawing] / 1x [drawing] = 21 studs in total Sample Ret.

Fixings panel nails screws hinges lace Sample Ret.

Timber type Sample Ret.

Interpretation / Comments

.....

db

SITE <u>OLR00</u>		COFFIN RECORD SHEET	CONTEXT NO. <u>378</u>
Trench:	Additional sheets: <u>WES X1</u>	Treatment: <u>BONE COLLECTED</u>	
Site sub-div: <u>NC</u>	Grave fills		
Plan no: <u>3</u>	Grave cut:	Finds None	
Section no:	Skeleton: <u>378</u>	Breastplate Grip	
Co-ordinates:	Matrix location: <u>378</u> <u>377</u>	Hinge <input checked="" type="checkbox"/> Bracket	
Levels	Preservation: <u>Good</u>	Fixing nails Shroud pins	
Slide No.	Neg No:	Fabric Other finds:	
Description <u>G-W ADULT</u>			
Discussion			
Shape, dimensions and distinguishing characteristics			
LID			
HEAD			
BASE			
Recorder:	Date:	Initials:	

Coffin Recording Sheet

Site Code

Context

OR200

398

Outer Coffin

Sample Ret.

Recording Date 6/12/00

Associated Numbers

Condition

Dep. Plate

Legible

Inscription

Fabric lead ormolou brass tin plated pewter gilt tin
 iron silvered tin enamelled other Sample Ret.

Shape of dep. plate

square rectangle shield tapered lozenge
 cartouche oval other

Upholstery

colour shoddy velvet other Sample Ret.

Construction

butt joint mitred pitched other

Grip plate

Fabric = ormolou brass tin plated pewter gilt tin
 iron *frgs on rev of grip-wrid* silvered tin enamelled other Sample Ret.

Grip

Fabric = ormolou brass iron *x4* Sample Ret.

Design

swag of rose horseshoe cherub's head plain

other *conc @'s*

Grip bolts

Corner bolts Type = gilt brass brass iron

other Sample Ret.

Lid motifs

other Sample Ret.

Escutcheons

other Sample Ret.

Upholstery nails

brass gilt brass silvered brass iron enamelled

other Sample Ret.

Fixings

panel nails screws hinges lace Sample Ret.

Timber type

..... Sample Ret.

Interpretation / Comments

.....

db.

SITE OROO	COFFIN RECORD SHEET	CONTEXT NO. 399
Trench:	Additional sheets: YES X 1.	Treatment: BONE COLLECTED
Site sub-div: NC	Grave fills	
Plan no: 3	Grave cut:	Finds None
Section no:	Skeleton: 399	Breastplate Grip
Co-ordinates:	Matrix location: 278 379	Hinge <input checked="" type="checkbox"/> Bracket
Levels	Preservation: GOOD	Fixing nails Shroud pins
Slide No.	Neg No:	Fabric Other finds

Description
S-W ADULT

Discussion

Shape, dimensions and distinguishing characteristics

LID

HEAD

BASE

Recorder:	Date:	Initials:
-----------	-------	-----------

Coffin Recording Sheet

Site Code

Context

Outer Coffin

Sample Ret.

07200

399

Recording Date 1/12/00

Associated Numbers

Condition

Dep. Plate

Legible

Inscription

Fabric lead ormolou brass tin plated pewter gilt tin
 iron silvered tin enamelled other Sample Ret.

Shape of dep. plate

square rectangle shield tapered lozenge
 cartouche oval other

Upholstery

colour shoddy velvet other Sample Ret.

Construction

butt joint mitred pitched other

Grip plate Fabric = ormolou brass tin plated pewter gilt tin
 iron silvered tin enamelled other Sample Ret.

Grip Fabric = ormolou brass iron x1 Sample Ret.

Design swag of rose horseshoe cherub's head plain
 other *same as 2280*

Grip bolts Corner bolts Type = gilt brass brass iron
 other Sample Ret.

Lid motifs other Sample Ret.

Escutcheons other Sample Ret.

Upholstery nails brass gilt brass silvered brass iron enamelled
 other Sample Ret.

Fixings panel nails screws hinges lace Sample Ret.

Timber type Sample Ret.

Interpretation / Comments

.....

SITE	COFFIN RECORD SHEET		CONTEXT NO.
BLR00	Additional sheets: YES X 2		400
Trench:	Grave fills	Treatment: BONES COLLECTED	
Site sub-div: NC	Grave cut:	Finds	
Plan no: 3	Skeleton: 400	None	
Section no:	Matrix location: 394 400 74	Breastplate ✓	
Co-ordinates:	Preservation: 403 404	Grip ✓	
Levels	PUCL	Hinge	
Slide No.	Neg No:	Bracket	
Description		Fixing nails	
Discussion		Shroud pins	
Shape, dimensions and distinguishing characteristics		Fabric	
LID		Other finds	
HEAD			
BASE			
Recorder:	Date:	Initials:	

6-W Adult very mouldy at least two chernalised babies placed below 400 (403, 404)

Coffin Recording Sheet

Site Code

Context

OK200

400

Outer Coffin

Sample Ret.

Recording Date 13/2/01

Associated Numbers

Condition 1

Dep. Plate

Legible 1st

Inscription *"Mr James ... p'd? / Died 2? A? / ?? 07 / Aged 19? Yes"*
new type, see over.

Fabric lead ormolou brass tin plated pewter gilt tin
 iron silvered tin enamelled other Sample Ret.

Shape of dep. plate

square rectangle *(fragmented)* shield tapered lozenge
 cartouche oval other

Upholstery

colour shoddy velvet other Sample Ret.

Construction . butt joint mitred pitched other

Grip plate Fabric = ormolou brass tin plated pewter gilt tin
 iron silvered tin enamelled other Sample Ret.

Grip Fabric = ormolou brass iron x1 Sample Ret.

Design swag of rose horseshoe cherub's head (4) plain
 other

Grip bolts **Corner bolts** Type = gilt brass brass iron
 other Sample Ret.

Lid motifs other Sample Ret.

Escutcheons other Sample Ret.

Upholstery nails brass gilt brass silvered brass iron enamelled
 other Sample Ret.

Fixings panel nails screws hinges lace Sample Ret.

Timber type Sample Ret.

Interpretation / Comments

.....

db.

SITE <i>OLR 00</i>	COFFIN RECORD SHEET	CONTEXT NO. <i>401</i>
Trench:	Additional sheets: <i>YES x1</i>	Treatment: <i>Bones collected.</i>
Site sub-div: <i>NL</i>	Grave fills <i>-</i>	
Plan no: <i>3</i>	Grave cut: <i>-</i>	Finds None
Section no:	Skeleton: <i>401</i>	Breastplate Grip
Co-ordinates:	Matrix location: <i>401</i> <i>402</i>	Hinge Bracket
Levels	Preservation: <i>GOOD.</i>	Fixing nails Shroud pins
Slide No.	Neg No:	Fabric Other finds
Description <i>E-W. Child burial, with head placed on pelvis of adult 402.</i>		
Discussion		
Shape, dimensions and distinguishing characteristics		
LID		
HEAD		
BASE		
Recorder: <i>D. Hall</i>	Date: <i>28.9.</i>	Initials:

Coffin Recording Sheet

Site Code

Context

Outer Coffin

Sample Ret.

OKL00

40/1004

Recording Date 6/12/00

Associated Numbers

Condition

Dep. Plate

Legible

Inscription

Fabric lead ormolou brass tin plated pewter gilt tin
 iron silvered tin enamelled other Sample Ret.

Shape of dep. plate

square rectangle shield tapered lozenge
 cartouche oval other

Upholstery

colour shoddy velvet other Sample Ret.

Construction

butt joint mitred pitched other

Grip plate Fabric = ormolou brass tin plated pewter gilt tin
 iron *cartouche - not enough to id.* silvered tin enamelled other Sample Ret.

Grip Fabric = ormolou brass iron *x2 infant 0's* Sample Ret.

Design swag of rose horseshoe cherub's head plain
 other *↔ 0.09* *↑ 0.04*

Grip bolts Corner bolts Type = gilt brass brass iron

other Sample Ret.

Lid motifs other Sample Ret.

Escutcheons other Sample Ret.

Upholstery *studs* brass gilt brass silvered brass iron enamelled
 other *1 x piece - 6 studs in total.* Sample Ret.

Fixings panel nails screws hinges lace Sample Ret.

Timber type Sample Ret.

Interpretation / Comments

.....

db.

SITE <i>OLR 00</i>		COFFIN RECORD SHEET	CONTEXT NO. <i>402</i>
Trench:	Additional sheets: <i>YES x 1.</i>	Treatment:	
Site sub-div: <i>NC</i>	Grave fills: <i>-</i>	Finds	
Plan no: <i>3</i>	Grave cut: <i>-</i>	None	
Section no:	Skeleton: <i>402</i>	Breastplate	
Co-ordinates:	Matrix location: <i>401</i> <i>402</i>	Grip	
Levels	Preservation: <i>GOOD.</i>	Hinge	
Slide No.	Neg No:	Bracket	
Description: <i>E-W adult burial, with 401's skull over pelvis.</i>		Fixing nails	
Discussion		Shroud pins	
Shape, dimensions and distinguishing characteristics			
LID			
HEAD			
BASE			
Recorder: <i>D. Azum</i>	Date: <i>28.9.</i>	Initials:	

Coffin Recording Sheet

Outer Coffin

Sample Ret.

Site Code

Context

Recording Date 22/11/00

ORCO

402

Associated Numbers

Condition

Dep. Plate

Legible

Inscription

Fabric lead ormolou brass tin plated pewter gilt tin
 iron silvered tin enamelled other Sample Ret.

Shape of dep. plate

square rectangle shield tapered lozenge
 cartouche oval other

Upholstery

colour shoddy velvet other Sample Ret.

Construction

butt joint mitred pitched other

Grip plate

Fabric = ormolou brass tin plated pewter gilt tin

iron silvered tin enamelled other Sample Ret.

cartouche on rev of small grip.

Grip

Fabric = ormolou brass iron *x4* Sample Ret.

Design

swag of rose horseshoe cherub's head plain

other *20's. 3 x ordinary + 1 x small*

Grip bolts

Corner bolts Type = gilt brass brass iron

other Sample Ret.

Lid motifs

other Sample Ret.

Escutcheons

other Sample Ret.

Upholstery nails

brass gilt brass silvered brass iron enamelled

other Sample Ret.

Fixings

panel nails screws hinges lace Sample Ret.

Timber type

Sample Ret.

Interpretation / Comments

.....

SITE 04200		COFFIN RECORD SHEET	CONTEXT NO. 403
Trench:	Additional sheets: 403/291	Treatment: BONES COLLECTED	
Site sub-div: NC	Grave fills		
Plan no: 3	Grave cut:	Finds None ✓	
Section no:	Skeleton: 403	Breastplate Grip	
Co-ordinates:	Matrix location: 400 403 = 404	Hinge Bracket	
Levels	Preservation: GOOD	Fixing nails Shroud pins	
Slide No.	Neg No:	Fabric Other finds	
<p>Description NON ARTICULATED, CHILD BURIAL MIXED WITH 404 & MAYBE MORE NUMBERED BECAUSE DISPERSED</p> <p>Discussion REDEPOSITION BELOW 400</p>			
<p>Shape, dimensions and distinguishing characteristics</p> <p>LID</p> <p>HEAD</p> <p>BASE</p>			
Recorder:	Date:	Initials:	

SITE		COFFIN RECORD SHEET		CONTEXT NO.	
0LR00				404	
Trench:		Additional sheets:		Treatment:	
Site sub-div: 8NC		Grave fills		BONES COLLECTED	
Plan no: 3		Grave cut:		Finds	
Section no:		Skeleton: 404		None ✓	
Co-ordinates:		Matrix location: 400 ┌┐ └┘ 404 = 403		Breastplate	
Levels		Preservation: GOOD		Grip	
Slide No.		Neg No:		Hinge	
Description		NOW ARTICULATED CHILD BURIAL MIXED WITH 403 AND OTHER? PLACED BELOW		Bracket	
Discussion		400 SO NUMBERED		Fixing nails	
Shape, dimensions and distinguishing characteristics				Shroud pins	
LID				Fabric	
HEAD				Other finds	
BASE					
Recorder:		Date:		Initials:	

SITE OLR 00	COFFIN RECORD SHEET	CONTEXT NO. 405
Trench:	Additional sheets:	Treatment: Bones collected.
Site sub-div: NC	Grave fills ✓	
Plan no: 3	Grave cut: ✓	Finds None
Section no:	Skeleton: 405	Breastplate Grip
Co-ordinates:	Matrix location: 405 406	Hinge Bracket
Levels:	Preservation: Good.	Fixing nails Shroud pins
Slide No.	Neg No:	Fabric Other finds
<p>Description E-W child burial (baby), overlying 406. Mixing of both bodies.</p> <p>Discussion</p>		
<p>Shape, dimensions and distinguishing characteristics</p> <p>LID</p> <p>HEAD</p> <p>BASE</p>		
Recorder: D. Armstrong	Date: 28.9.	Initials:

SITE <i>OR SD</i>		COFFIN RECORD SHEET		CONTEXT NO. <i>406</i>	
Trench:		Additional sheets: <i>YES x 1.</i>		Treatment: <i>Bones collected.</i>	
Site sub-div: <i>NC</i>		Grave fills: <i>-</i>		Finds None	
Plan no: <i>3</i>		Grave cut: <i>-</i>			
Section no:		Skeleton: <i>406</i>		Breastplate	
Co-ordinates:		Matrix location: <i>405</i> <i>406</i>		Grip	
Levels:		Preservation: <i>Good.</i>		Hinge	
Slide No.:		Neg No.:		Bracket	
				Fixing nails	
				Shroud pins	
				Fabric	
				Other finds	
Description <i>E-W Juvinate burial, over underlies 405, mixed slightly.</i>					
Discussion					
Shape, dimensions and distinguishing characteristics					
LID					
HEAD					
BASE					
Recorder:		Date:		Initials:	

Coffin Recording Sheet

Site Code

Context

Outer Coffin

Sample Ret.

02R00

406

Recording Date 29/11/00

Associated Numbers

Condition

Dep. Plate

Legible

Inscription

Fabric lead ormolou brass tin plated pewter gilt tin
 iron silvered tin enamelled other Sample Ret.

Shape of dep. plate

square rectangle shield tapered lozenge
 cartouche oval other

Upholstery

colour shoddy velvet other Sample Ret.

Construction

butt joint mitred pitched other

Grip plate

Fabric = ormolou brass tin plated pewter gilt tin
 iron *frogs on rev. of grip* silvered tin enamelled other Sample Ret.

Grip

Fabric = ormolou brass iron *el* Sample Ret.

Design

swag of rose horseshoe cherub's head plain

other *① intents ←→ 0.09 ↓ 0.04*

Grip bolts

Corner bolts Type = gilt brass brass iron

other Sample Ret.

Lid motifs

other Sample Ret.

Escutcheons

other Sample Ret.

Upholstery nails

brass gilt brass silvered brass iron enamelled

other Sample Ret.

Fixings

panel nails screws hinges lace Sample Ret.

Timber type

..... Sample Ret.

Interpretation / Comments

.....

db.

SITE 02200	COFFIN RECORD SHEET	CONTEXT NO. 407
Trench:	Additional sheets: YES x 1.	Treatment:
Site sub-div: NC	Grave fills	Bones (all 506)
Plan no: 3	Grave cut:	Finds None
Section no:	Skeleton: 407	Breastplate Grip
Co-ordinates:	Matrix location: 407 408	Hinge <input checked="" type="checkbox"/> Bracket
Levels	Preservation: Good	Fixing nails Shroud pins
Slide No.	Neg No:	Fabric Other finds

Description

Adult GW

Discussion

Shape, dimensions and distinguishing characteristics

LID

HEAD

BASE

Recorder: <i>JW</i>	Date: 28/1/00	Initials:
---------------------	---------------	-----------

Coffin Recording Sheet

Site Code

Context

Outer Coffin

Sample Ret.

oh100

407

Recording Date 29/11/00

Associated Numbers

Condition

Dep. Plate

Legible

Inscription

Fabric lead ormolou brass tin plated pewter gilt tin
 iron silvered tin enamelled other Sample Ret.

Shape of dep. plate

square rectangle shield tapered lozenge
 cartouche oval other

Upholstery

colour shoddy velvet other *boize* Sample Ret.

Construction

butt joint mitred pitched other

Grip plate

Fabric = ormolou brass tin plated pewter gilt tin
 iron *rogs on rev of grip - unid.* silvered tin enamelled other Sample Ret.

Grip

Fabric = ormolou brass iron X2 Sample Ret.

Design

swag of rose horseshoe cherub's head plain
 other 228

Grip bolts

Corner bolts Type = gilt brass brass iron

other Sample Ret.

Lid motifs

other Sample Ret.

Escutcheons

other Sample Ret.

Upholstery nails

brass gilt brass silvered brass iron enamelled
 other *studs* *2x pieces - 1x* *ooooo / oooo* *1x ooooo = 14 studs in total.* Sample Ret.

Fixings

panel nails screws hinges lace Sample Ret.

Timber type

Sample Ret.

Interpretation / Comments

.....

SITE		COFFIN RECORD SHEET		CONTEXT NO.	
02200				408	
Trench:		Additional sheets:		Treatment:	
Site sub-div: NC		Grave fills		BONES COLLECTED	
Plan no: 3		Grave cut:		Finds	
Section no:		Skeleton: 408		None	
Co-ordinates:		Matrix location: 407 408		Breastplate	
Levels		Preservation: (good)		Grip	
Slide No.		Neg No:		Hinge	
				Bracket	
				Fixing nails	
				Shroud pins ✓	
				Fabric	
				Other finds	
				:	
Description					
6-W BURIAL					
Discussion					
Shape, dimensions and distinguishing characteristics					
LID					
HEAD					
BASE					
Recorder: JH		Date: 28/9/00		Initials:	

SITE		COFFIN RECORD SHEET		CONTEXT NO. 409	
Trench:	GL200	Additional sheets:		Treatment:	BONES COLLECTED
Site sub-div:	NC	Grave fills		Finds	None
Plan no:	3	Grave cut:		Breastplate	
Section no:		Skeleton:	409	Grip	
Co-ordinates:		Matrix location:	410 VAULT 409	Hinge	
Levels		Preservation:	GOOD	Bracket	
Slide No.		Neg No:		Fixing nails	
Description		6-W BURIAL			
Discussion					
Shape, dimensions and distinguishing characteristics					
LID					
HEAD					
BASE					
Recorder:	AH	Date:	28/9/00	Initials:	

SITE	COLLECTOR	CONTEXT NO.
OLR 00		410
Trench:	Additional sheets:	Treatment:
Site sub-div: NC	Grave fills ✓	Bones collected
Plan no: 3	Grave cut: ✓	Finds
Section no:	Skeleton: 410	None
Co-ordinates:	Matrix location: Truncates 409	Breastplate
Levels	Preservation: 409	Grip
Slide No.	Neg No:	Hinge
		Bracket
		Fixing nails
		Shroud pins
		Fabric
		Other finds

Description E-W adult burial.

Discussion

Shape, dimensions and distinguishing characteristics

LID

HEAD

BASE

Recorder: D. Hall	Date: 28.9.	Initials:
-------------------	-------------	-----------

SITE		COFFIN RECORD SHEET		CONTEXT NO.	
OLR 00				411	
Trench:		Additional sheets:		Treatment:	
Site sub-div: NC		Grave fills -		Bones collected.	
Plan no: 3		Grave cut: -		Finds	
Section no:		Skeleton: 411		None	
Co-ordinates:		Matrix location: 411		Breastplate	
Levels		Preservation: Good		Grip	
Slide No.		Neg No:		Hinge	
Description		E-W adult burial.		Bracket	
Discussion				Fixing nails	
Shape, dimensions and distinguishing characteristics				Shroud pins	
LID				Fabric	
HEAD				Other finds	
BASE				:	
Recorder:		Date:		Initials:	

SITE		COFFIN RECORD SHEET		CONTEXT NO.	
OLR 00				412	
Trench:		Additional sheets:		Treatment: Bones collected.	
Site sub-div: NC		Grave fills: —			
Plan no: 3		Grave cut: —		Finds	
				None	
Section no:		Skeleton: 412		Breastplate	
				Grip	
Co-ordinates:		Matrix location: 412 410		Hinge	
				Bracket	
Levels		Preservation: Fair.		Fixing nails	
				Shroud pins	
Slide No.		Neg No:		Fabric	
				Other finds	
Description: E-W neonate/baby burial. Head on pelvis of 410					
Discussion					
Shape, dimensions and distinguishing characteristics					
LID					
HEAD					
BASE					
Recorder: D. H. M.		Date: 28.9.		Initials:	

SITE <i>OLR 00</i>		COFFIN RECORD SHEET		CONTEXT NO. <i>413</i>	
Trench:		Additional sheets:		Treatment: <i>Bones collected.</i>	
Site sub-div: <i>NC</i>		Grave fills: <i>-</i>			
Plan no: <i>3</i>		Grave cut: <i>-</i>		Finds	
Section no:		Skeleton: <i>413</i>		None	
Co-ordinates:		Matrix location: <i>398</i> <i>399</i> <i>413</i>		Breastplate	
Levels		Preservation: <i>Fair.</i>		Grip	
Slide No.		Neg No:		Hinge	
				Bracket	
				Fixing nails	
				Shroud pins	
				Fabric	
				Other finds	
<p>Description <i>E-W adult, but only legs surviving - no feet or upper body. Feet presumably truncated by vault, upper body possibly truncated by 399, or unknown feature.</i></p> <p>Discussion</p>					
<p>Shape, dimensions and distinguishing characteristics</p> <p>LID</p> <p>HEAD</p> <p>BASE</p>					
Recorder: <i>D. Hall</i>		Date: <i>28.9.</i>		Initials:	

db.

SITE <u>OLR 00</u>		COFFIN RECORD SHEET	CONTEXT NO. <u>414</u>
Trench:	Additional sheets: <u>YES XI</u>	Treatment: <u>Bones collected.</u>	
Site sub-div: <u>NC</u>	Grave fills: <u>—</u>		
Plan no: <u>3</u>	Grave cut: <u>—</u>	Finds None	
Section no:	Skeleton: <u>414</u>	Breastplate Grip	
Co-ordinates:	Matrix location: <u>410</u> <u>414</u>	Hinge Bracket	
Levels	Preservation: <u>GOOD.</u>	Fixing nails Shroud pins	
Slide No.	Neg No:	Fabric Other finds	
Description <u>E-W adult burial underlying 410.</u>			
Discussion			
Shape, dimensions and distinguishing characteristics			
LID			
HEAD			
BASE			
Recorder: <u>D. Hall</u>	Date: <u>28.9.</u>	Initials:	

Outer Coffin

Sample Ret.

Site Code

Context

OLK00

A1A

Recording Date A12100

Associated Numbers

Condition

Dep. Plate

Legible

Inscription

Fabric lead ormolou brass tin plated pewter gilt tin
 iron silvered tin enamelled other Sample Ret.

Shape of dep. plate

square rectangle shield tapered lozenge
 cartouche oval other

Upholstery

colour shoddy velvet other Sample Ret.

Construction

butt joint mitred pitched other

Grip plate Fabric = ormolou brass tin plated pewter gilt tin
 iron *frag of cartouche on rev of grips* silvered tin enamelled other Sample Ret.

Grip Fabric = ormolou brass iron *x2* Sample Ret.

Design swag of rose horseshoe cherub's head *2015* plain
 other

Grip bolts Corner bolts Type = gilt brass brass iron

other Sample Ret.

Lid motifs other Sample Ret.

Escutcheons other Sample Ret.

Upholstery nails brass gilt brass silvered brass iron enamelled

other Sample Ret.

Fixings panel nails screws hinges lace Sample Ret.

Timber type Sample Ret.

Interpretation / Comments

.....

db

SITE	COFFIN RECORD SHEET	CONTEXT NO.
OLR00	Additional sheets: YES X1	415
Trench:	Grave fills	Treatment: BONES COLLECTED
Site sub-div: NC	Grave cut:	Finds
Plan no: 3	Skeleton: 415	None
Section no:	Matrix location: 415	Breastplate
Co-ordinates:	Preservation: FAIR	Grip
Levels	Slide No.	Hinge
Neg No:	Other finds	Bracket
Description	Discussion	Fixing nails
Shape, dimensions and distinguishing characteristics	LID	Shroud pins
HEAD	Recorder: JH	Fabric
BASE	Date: 29/9/00	Other finds
Recorder: JH	Date: 29/9/00	Initials:

6-W Adult TRUNCATED

Site Code

Context

Outer Coffin

Sample Ret.

OR 200

A15

Recording Date *4/12/00*

Associated Numbers

Condition

Dep. Plate

Legible

Inscription

Fabric lead ormolou brass tin plated pewter gilt tin
 iron silvered tin enamelled other Sample Ret.

Shape of dep. plate

square rectangle shield tapered lozenge
 cartouche oval other

Upholstery

colour shoddy velvet other Sample Ret.

Construction

butt joint mitred pitched other

Grip plate

Fabric = ormolou brass tin plated pewter gilt tin
frags on rev. of grip.
 iron silvered tin enamelled other Sample Ret.

Grip

Fabric = ormolou brass ^{x1} iron Sample Ret.

Design

swag of rose horseshoe cherub's head plain

other *too conc. to id.*

Grip bolts

Corner bolts Type = gilt brass brass iron

other Sample Ret.

Lid motifs

other Sample Ret.

Escutcheons

other Sample Ret.

Upholstery

studs brass *3 pieces* gilt brass silvered brass iron enamelled
 other *1x coverage / 1x oval / 1x ~~coverage~~ = 27 studs in total.* Sample Ret.

Fixings

panel nails screws hinges lace Sample Ret.

Timber type

Sample Ret.

Interpretation / Comments

.....

db

SITE OLR00	COFFIN RECORD SHEET	CONTEXT NO. 416
Trench:	Additional sheets: YES x 1	Treatment: BONES COLLECTED
Site sub-div: NC	Grave fills	
Plan no: 3	Grave cut:	Finds None
Section no:	Skeleton: 416	Breastplate Grip
Co-ordinates:	Matrix location: 416	Hinge Bracket
Levels	Preservation: FAIR	Fixing nails Shroud pins
Slide No.	Neg No:	Fabric Other finds

Description 6-W Adult TRUNCATED

Discussion

Shape, dimensions and distinguishing characteristics

LID

HEAD

BASE

Recorder: <i>[Signature]</i>	Date: 29/9/02	Initials:
------------------------------	---------------	-----------

Site Code

Context

Outer Coffin

Sample Ret.

02K00

416
~~2211/00~~

Recording Date 22/11/00

Associated Numbers

Condition

Dep. Plate

Legible

Inscription

Fabric lead ormolou brass tin plated pewter gilt tin
iron silvered tin enamelled other Sample Ret.

Shape of dep. plate

square rectangle shield tapered lozenge
cartouche oval other

Upholstery

colour shoddy velvet other Sample Ret.

Construction

butt joint mitred pitched other

Grip plate Fabric = ormolou brass tin plated pewter gilt tin
iron silvered tin enamelled other Sample Ret.

Grip Fabric = ormolou brass iron K3 Sample Ret.

Design swag of rose horseshoe cherub's head plain
other to conc. to id.

Grip bolts Corner bolts Type = gilt brass brass iron
other Sample Ret.

Lid motifs other Sample Ret.

Escutcheons other Sample Ret.

Upholstery nails brass gilt brass silvered brass iron enamelled
other Sample Ret.

Fixings panel nails screws hinges lace Sample Ret.

Timber type Sample Ret.

Interpretation / Comments

.....
.....

SITE	COFFIN RECORD SHEET	CONTEXT NO.
OLROW	Additional sheets:	417
Trench:	Grave fills	Treatment: BONES COLLECTED
Site sub-div: NZ	Grave cut:	Finds
Plan no: 3	Skeleton:	None
Section no:	417	Breastplate
Co-ordinates:	Matrix location: 417	Grip
Levels	Preservation: POOR	Hinge
Slide No.	Neg No:	Bracket
Description		Fixing nails
6-W Adult V. truncated.		Shroud pins
Discussion		Fabric
Shape, dimensions and distinguishing characteristics		Other finds
<p>LID</p> <p>HEAD</p> <p>BASE</p>		
Recorder: JW	Date: 29/1/02	Initials:

SITE	COFFIN RECORD SHEET		CONTEXT NO. 418
Trench: <i>nr 200</i>	Additional sheets:	Treatment: <i>BONES COLLECTED</i>	
Site sub-div: <i>NC</i>	Grave fills		
Plan no: <i>3</i>	Grave cut:	Finds None	
Section no:	Skeleton: <i>418</i>	Breastplate Grip	
Co-ordinates:	Matrix location: <i>418</i> <i>421</i>	Hinge Bracket	
Levels	Preservation: <i>FAIR</i>	Fixing nails Shroud pins	
Slide No.	Neg No:	Fabric Other finds :	
Description <i>6-W BURIAL TRUNCATED</i>			
Discussion			
Shape, dimensions and distinguishing characteristics			
LID			
HEAD			
BASE			
Recorder: <i>[Signature]</i>	Date: <i>29/9/00</i>	Initials:	

SITE	COFFIN RECORD SHEET	CONTEXT NO.
Trench: <i>GR200</i>	Additional sheets:	Treatment: <i>419</i>
Site sub-div: <i>NC</i>	Grave fills	<i>BONES COLLECTED</i>
Plan no: <i>3</i>	Grave cut:	Finds None
Section no:	Skeleton: <i>419</i>	Breastplate Grip
Co-ordinates:	Matrix location: <i>419</i>	Hinge Bracket
Levels	Preservation: <i>FAIR</i>	Fixing nails Shroud pins
Slide No.	Neg No:	Fabric Other finds
<p>Description <i>6-W TRUNCATED ADULT</i></p> <p>Discussion</p>		
<p>Shape, dimensions and distinguishing characteristics</p> <p>LID</p> <p>HEAD</p> <p>BASE</p>		
Recorder: <i>JH</i>	Date: <i>29/2/00</i>	Initials:

SITE		COFFIN RECORD SHEET		CONTEXT NO. 420	
Trench: 0LR00		Additional sheets:		Treatment:	
Site sub-div: NC		Grave fills		BANDS COLLECTED	
Plan no: 3		Grave cut:		Finds	
Section no:		Skeleton: 420		None	
Co-ordinates:		Matrix location: 420		Breastplate	
Levels		Preservation: 420 FAIR		Grip	
Slide No.		Neg No:		Hinge	
Description		6W MULT TRUNCATED AT HEAD		Bracket	
Discussion				Fixing nails	
Shape, dimensions and distinguishing characteristics				Shroud pins	
LID				Fabric	
HEAD				Other finds	
BASE					
Recorder:		Date: 29/1/00		Initials:	

db

SITE UL200	COFFIN RECORD SHEET	CONTEXT NO. 421
Trench:	Additional sheets: YES x 1.	Treatment: BONES COLLECTED
Site sub-div: NC	Grave fills	
Plan no: 3	Grave cut:	Finds None ✓
Section no:	Skeleton: 421	Breastplate Grip
Co-ordinates:	Matrix location: 418 421	Hinge Bracket
Levels	Preservation: GOOD	Fixing nails Shroud pins
Slide No.	Neg No:	Fabric Other finds

Description
G-W ADULT R. SIDE TRUNCATED

Discussion

Shape, dimensions and distinguishing characteristics

LID

HEAD

BASE

Recorder: Jhr	Date: 29/9/00	Initials:
---------------	---------------	-----------

Coffin Recording Sheet

Site Code

Context

Outer Coffin

Sample Ret.

OK200

421

Recording Date 28/11/00

Associated Numbers

Condition

Dep. Plate

Legible

Inscription

Fabric lead ormolou brass tin plated pewter gilt tin
 iron silvered tin enamelled other Sample Ret.

Shape of dep. plate

square rectangle shield tapered lozenge
 cartouche oval other

Upholstery

colour shoddy velvet other Sample Ret.

Construction

butt joint mitred pitched other

Grip plate

Fabric = ormolou brass tin plated pewter gilt tin
 iron silvered tin enamelled other Sample Ret.
leags on rev. of grip - mid.

Grip

Fabric = ormolou brass iron XI. Sample Ret.

Design

swag of rose horseshoe cherub's head plain

other

Grip bolts

Corner bolts Type = gilt brass brass iron

other Sample Ret.

Lid motifs

other Sample Ret.

Escutcheons

other Sample Ret.

Upholstery nails

brass gilt brass silvered brass iron enamelled

other Sample Ret.

Fixings

panel nails screws hinges lace Sample Ret.

Timber type

Sample Ret.

Interpretation / Comments

.....

Ab.

SITE		COFFIN RECORD SHEET		CONTEXT NO.	
02200				422	
Trench:		Additional sheets: YES x 1		Treatment:	
Site sub-div: NC		Grave fills		BONES COLLECTED	
Plan no: 3		Grave cut:		Finds	
Section no:		Skeleton: 422		None	
Co-ordinates:		Matrix location: 420 422		Breastplate	
Levels		Preservation: 423 GOOD - FAIR		Grip	
Slide No.		Neg No:		Hinge	
Description				Bracket	
Discussion				Fixing nails	
Shape, dimensions and distinguishing characteristics				Shroud pins	
LID				Fabric	
HEAD				Other finds	
BASE					
Recorder: a/w		Date: 29/9/00		Initials:	

HEAVILY TRUNCATED
S-W ADULT

Site Code

Context

Outer Coffin

Sample Ret.

OKR00

A22

Recording Date 27/11/00

Associated Numbers

Condition

Dep. Plate

Legible

Inscription

Fabric lead ormolou brass tin plated pewter gilt tin
 iron silvered tin enamelled other Sample Ret.

Shape of dep. plate

square rectangle shield tapered lozenge
 cartouche oval other

Upholstery

colour shoddy velvet other Sample Ret.

Construction

butt joint mitred pitched other

Grip plate Fabric = ormolou brass tin plated pewter gilt tin
 iron *fragson lev of grip-wood.* silvered tin enamelled other Sample Ret.

Grip Fabric = ormolou brass iron *x1* Sample Ret.

Design swag of rose horseshoe cherub's head **(30)** plain
 other

Grip bolts Corner bolts Type = gilt brass brass iron

other Sample Ret.

Lid motifs other Sample Ret.

Escutcheons other Sample Ret.

Upholstery nails brass gilt brass silvered brass iron enamelled

other Sample Ret.

Fixings panel nails screws hinges lace Sample Ret.

Timber type Sample Ret.

Interpretation / Comments

.....

db.

SITE OLROC	COFFIN RECORD SHEET	CONTEXT NO. 423
Trench:	Additional sheets: YES x 1	Treatment:
Site sub-div: NC	Grave fills	
Plan no: 3	Grave cut:	Finds None ✓
Section no:	Skeleton: 423 422	Breastplate Grip
Co-ordinates:	Matrix location: 423 425	Hinge Bracket
Levels	Preservation: 424 FAIR 426	Fixing nails Shroud pins
Slide No.	Neg No:	Fabric Other finds

Description
TRUNCATED 6-W BABY BURIAL

Discussion

Shape, dimensions and distinguishing characteristics

LID

HEAD

BASE

Recorder: <i>[Signature]</i>	Date: 29/9/00	Initials:
------------------------------	---------------	-----------

Coffin Recording Sheet

Site Code

Context

02000

423

Outer Coffin

Sample Ret.

Recording Date 16/11/00

Associated Numbers

Condition

Dep. Plate

Legible

Inscription

Fabric lead ormolou brass tin plated pewter gilt tin
iron silvered tin enamelled other Sample Ret.

Shape of dep. plate

square rectangle shield tapered lozenge
cartouche oval other

Upholstery

colour shoddy velvet other Sample Ret.

Construction

butt joint mitred pitched other

Grip plate Fabric = ormolou brass tin plated pewter gilt tin
frags on rev of grip. iron silvered tin enamelled other Sample Ret.

Grip Fabric = ormolou brass iron *x1 intent.* Sample Ret.

Design swag of rose horseshoe cherub's head plain
other *↔ 0.09 ↑ 0.05 ①*

Grip bolts Corner bolts Type = gilt brass brass iron
other Sample Ret.

Lid motifs other Sample Ret.

Escutcheons other Sample Ret.

Upholstery *studs* brass gilt brass silvered brass iron enamelled
other *x 2 studs (oo)* Sample Ret.

Fixings panel nails screws hinges lace Sample Ret.

Timber type Sample Ret.

Interpretation / Comments

.....
.....

SITE	COFFIN RECORD SHEET	CONTEXT NO.
OLRUU	Additional sheets: 428 x 1.	424
Trench:	Grave fills	Treatment: Bones collected
Site sub-div: NC	Grave cut:	Finds
Plan no: 3	Skeleton: 424	None
Section no:	Matrix location: 425 424 426	Breastplate
Co-ordinates:	Preservation:	Grip ✓
Levels	Neg No:	Hinge
Slide No.	Shape, dimensions and distinguishing characteristics	Bracket
<p>Description</p> <p>6-W Adult Burial:</p> <p>for wife of 426</p> <p>Discussion</p>		
<p>LID</p> <p>HEAD</p> <p>BASE</p>		
Recorder: [Signature]	Date: 29/9/00	Initials:

Site Code

Context

Outer Coffin

Sample Ret.

OH200

424

Recording Date 27/11/00

Associated Numbers

Condition

Dep. Plate

Legible

Inscription

Fabric lead ormolou brass tin plated pewter gilt tin
 iron silvered tin enamelled other Sample Ret.

Shape of dep. plate

square rectangle shield tapered lozenge
 cartouche oval other

Upholstery

colour shoddy velvet other *boize* Sample Ret.
ferrous on rev of stud.

Construction

butt joint mitred pitched other

Grip plate

Fabric = ormolou brass tin plated pewter gilt tin
 iron silvered tin enamelled other Sample Ret.

Flags on rev of grip - unid; w/ 1x fe stud conc @ bottom centre

Grip

Fabric = ormolou brass iron X5 Sample Ret.

Design

swag of rose horseshoe cherub's head *(A)5* plain

other

Grip bolts

Corner bolts Type = gilt brass brass iron

other Sample Ret.

Lid motifs

other Sample Ret.

Escutcheons

other Sample Ret.

Upholstery *studs*

brass gilt brass silvered brass iron enamelled

other *1x 0000 / 1x 0 = 5 studs in total.* Sample Ret.

Fixings

panel nails screws hinges lace Sample Ret.

Timber type

Sample Ret.

Interpretation / Comments

.....

db

SITE		COFFIN RECORD SHEET		CONTEXT NO.	
JLR00				425	
Trench:		Additional sheets: YES x 1.		Treatment:	
Site sub-div: NC		Grave fills		BONES COLLECTED	
Plan no: 3		Grave cut:		Finds	
Section no:		Skeleton: 425		None	
Co-ordinates:		Matrix location: 425 424		Breastplate	
Levels		Preservation: GOOD		Grip ✓	
Slide No.		Neg No:		Hinge	
Description				Bracket	
Discussion				Fixing nails	
Shape, dimensions and distinguishing characteristics				Shroud pins	
LID				Fabric	
HEAD				Other finds	
BASE					
Recorder: [Signature]		Date: 29/9/00		Initials:	

Site Code

Context

OKR00

425

Outer Coffin

Sample Ret.

Recording Date 17/11/00

Associated Numbers

Condition

Dep. Plate

Legible

Inscription

Fabric lead ormolou brass tin plated pewter gilt tin
 iron silvered tin enamelled other Sample Ret.

Shape of dep. plate

square rectangle shield tapered lozenge
 cartouche oval other

Upholstery

colour shoddy velvet other Sample Ret.

Construction

butt joint mitred pitched other

Grip plate Fabric = ormolou brass tin plated pewter gilt tin
 iron silvered tin enamelled other Sample Ret.

Grip Fabric = ormolou brass iron Sample Ret.

Design swag of rose horseshoe cherub's head plain

other

Grip bolts **Corner bolts** **Type =** gilt brass brass iron

other Sample Ret.

Lid motifs other Sample Ret.

Escutcheons other Sample Ret.

Upholstery ^{shubs} nails brass gilt brass silvered brass iron enamelled

other 0 8 = 6g / 1 x 0000 1 x 0000 3 x 000 = smaller = total 21 (7 pieces) Sample Ret.

Fixings ^{lid ↑ ? edge} panel nails screws hinges lace Sample Ret.

Timber type Sample Ret.

Interpretation / Comments

.....

SITE OLMUU	COFFIN RECORD SHEET	CONTEXT NO. 426
Trench:	Additional sheets: YES XI.	Treatment:
Site sub-div: NC	Grave fills	SWORDS COLLECTED
Plan no: 3	Grave cut:	Finds None
Section no:	Skeleton: 426	Breastplate Grip ✓
Co-ordinates:	Matrix location: 424 426	Hinge Bracket
Levels	Preservation: GOOD	Fixing nails Shroud pins
Slide No.	Neg No:	Fabric Other finds
Description 6-6 Adult burial poss husband of 424		
Discussion LOADS OF CHARNAZ IN CUT		
Shape, dimensions and distinguishing characteristics LID HEAD BASE		
Recorder: [Signature]	Date: 29/9/00	Initials:

Coffin Recording Sheet

Outer Coffin

Sample Ret.

Site Code

Context

Orl00

426

Recording Date *5/12/00*

Associated Numbers

Condition

Dep. Plate

Legible

Inscription

Fabric lead ormolou brass tin plated pewter gilt tin
 iron silvered tin enamelled other Sample Ret.

Shape of dep. plate

square rectangle shield tapered lozenge
 cartouche oval other

Upholstery

colour shoddy velvet other Sample Ret.

Construction

butt joint mitred pitched other

Grip plate

Fabric = ormolou brass tin plated pewter gilt tin
Progs on rev of grip
 iron silvered tin enamelled other Sample Ret.

Grip

Fabric = ormolou brass iron *x2* Sample Ret.

Design

swag of rose horseshoe cherub's head *(4)'s* plain

other

Grip bolts

Corner bolts Type = gilt brass brass iron

other Sample Ret.

Lid motifs

other Sample Ret.

Escutcheons

other Sample Ret.

Upholstery nails

brass gilt brass silvered brass iron enamelled

other Sample Ret.

Fixings

panel nails screws hinges lace Sample Ret.

Timber type

fe plate - corner shaped - unid.

Sample Ret.

Interpretation / Comments

.....

SITE		COFFIN RECORD SHEET		CONTEXT NO. 427	
Trench:	01200	Additional sheets:		Treatment:	BONES COLLECTED
Site sub-div:	NC	Grave fills			
Plan no:	3	Grave cut:		Finds	None ✓
Section no:		Skeleton:	427	Breastplate	
Co-ordinates:		Matrix location:	427	Grip	
Levels		Preservation:		Hinge	
Slide No.		Neg No:		Bracket	
				Fixing nails	
				Shroud pins	
				Fabric	
				Other finds	
Description Adult 6-w Mached out so fragmentary.					
Discussion					
Shape, dimensions and distinguishing characteristics					
LID					
HEAD					
BASE					
Recorder:		Date:	29/9/00	Initials:	

SITE <i>oe 20e</i>		COFFIN RECORD SHEET		CONTEXT NO. <i>428</i>	
Trench:	Additional sheets:	Treatment: <i>BONES COLLECTED</i>			
Site sub-div: <i>NC</i>	Grave fills	Finds DATA			
Plan no: <i>3</i>	Grave cut:	None			
Section no:	Skeleton: <i>428</i>	Breastplate			
Co-ordinates:	Matrix location: <i>428</i> <i>429</i>	Grip <i>unid.</i>			
Levels	Preservation: <i>GOOD</i>	Hinge			
Slide No.	Neg No:	Bracket			
Description <i>Adult E-W TRUNCATED BY VAULT</i>		Fixing nails			
Discussion		Shroud pins <i>21</i> ✓			
Shape, dimensions and distinguishing characteristics		Fabric			
LID		Other finds			
HEAD					
BASE					
Recorder: <i>AW</i>	Date: <i>29/7/00</i>	Initials:			

SITE 01200	COFFIN RECORD SHEET	CONTEXT NO. 429
Trench:	Additional sheets:	Treatment:
Site sub-div: NC	Grave fills	BONES COLLECTED
Plan no: 3	Grave cut:	Finds
Section no:	Skeleton: 429	None
Co-ordinates:	Matrix location: 428 429 433	Breastplate
Levels	Preservation: GOOD	Grip
Slide No.	Neg No:	Hinge
		Bracket
		Fixing nails
		Shroud pins
		Fabric
		Other finds

Description

ADULT 6-w.

Discussion

Shape, dimensions and distinguishing characteristics

LID

HEAD

BASE

Recorder:

JW

Date:

2/10/00

Initials:

SITE		COFFIN RECORD SHEET		CONTEXT NO.	
02/200				430	
Trench:		Additional sheets: YES x1.		Treatment:	
Site sub-div: NC		Grave fills		BONES COLLECTED	
Plan no: 3		Grave cut:		Finds	
Section no:		Skeleton: 430		None	
Co-ordinates:		Matrix location: 431 430		Breastplate	
Levels		Preservation: 1 435		Grip	
Slide No.		Neg No:		Hinge	
				Bracket	
				Fixing nails	
				Shroud pins	
				Fabric	
				Other finds	

Description TRUNCATED ARCT (S-W)

Discussion

Shape, dimensions and distinguishing characteristics

LID

HEAD

BASE

Recorder: <i>[Signature]</i>	Date: 2/10/00	Initials:
------------------------------	---------------	-----------

Site Code

Context

Outer Coffin

Sample Ret.

OLR00

430

Recording Date 17/11/00

Associated Numbers

Condition

Dep. Plate

Legible

Inscription

Fabric lead ormolou brass tin plated pewter gilt tin
 iron silvered tin enamelled other Sample Ret.

Shape of dep. plate

square rectangle shield tapered lozenge
 cartouche oval other

Upholstery

colour shoddy velvet other Sample Ret.

Construction

butt joint mitred pitched other

Grip plate Fabric = ormolou brass tin plated pewter gilt tin
 iron silvered tin enamelled other Sample Ret.

Grip Fabric = ormolou brass iron Sample Ret.

Design swag of rose horseshoe cherub's head plain
 other too conc. to id

Grip bolts **Corner bolts** **Type =** gilt brass brass iron

other Sample Ret.

Lid motifs other Sample Ret.

Escutcheons other Sample Ret.

Upholstery ^{studs} nails brass gilt brass silvered brass iron enamelled
 other 2 x studs conc. to grip Sample Ret.

Fixings panel nails screws hinges lace Sample Ret.

Timber type Sample Ret.

Interpretation / Comments

.....

SITE	COFFIN RECORD SHEET		CONTEXT NO.
02R00	Additional sheets:		431
Trench:	Grave fills	BONES COLLECTED	
Site sub-div: NC	Grave cut:		
Plan no: 3	Skeleton: 432 431 430	Finds	
Section no:	Matrix location: 430	None	
Co-ordinates:	Preservation:	Breastplate	
Levels	Neg No:	Grip	
Slide No.	Description	Hinge	
ADULT 6-W TRUNCATED			
Discussion			
Shape, dimensions and distinguishing characteristics			
LID			
HEAD			
BASE			
Recorder: [Signature]	Date: 2/10/00	Initials:	

SITE 02R00	COFFIN RECORD SHEET	CONTEXT NO. 432
Trench:	Additional sheets:	Treatment:
Site sub-div: NC	Grave fills	BONES COLLECTED
Plan no: 3	Grave cut:	Finds None
Section no:	Skeleton: 432	Breastplate Grip
Co-ordinates:	Matrix location: 432 431	Hinge Bracket
Levels	Preservation: GOOD	Fixing nails Shroud pins
Slide No.	Neg No:	Fabric Other finds

Description
ADULT 6-W TRUNCATED

Discussion

Shape, dimensions and distinguishing characteristics

LID

HEAD

BASE

Recorder: J.R.	Date: 2/10/00	Initials:
----------------	---------------	-----------

SITE <i>OLR 00</i>		COFFIN RECORD SHEET		CONTEXT NO. <i>433</i>	
Trench:		Additional sheets:		Treatment: <i>Bones collected.</i>	
Site sub-div: <i>NC</i>		Grave fills: <i>-</i>			
Plan no: <i>3</i>		Grave cut: <i>-</i>		Finds	
Section no:		Skeleton: <i>433</i>		None	
Co-ordinates:		Matrix location: <i>429</i> - <i>Truncates</i> <i>433</i> also.		Breastplate	
Levels		Preservation: <i>Fair.</i>		Grip	
Slide No.		Neg No:		Hinge	
				Bracket	
				Fixing nails	
				Shroud pins	
				Fabric	
				Other finds	
Description <i>ADULT E-W burial, top half truncated by 429</i>					
Discussion					
Shape, dimensions and distinguishing characteristics					
LID					
HEAD					
BASE					
Recorder: <i>D. Hall</i>		Date: <i>2.10.00</i>		Initials:	

SITE		COFFIN RECORD SHEET		CONTEXT NO.	
OLROO				434	
Trench:		Additional sheets:		Treatment:	
Site sub-div:		Grave fills		BUNGS COLLECTED	
Plan no: NE 3		Grave cut:		Finds	
Section no:		Skeleton: 434		None	
Co-ordinates:		Matrix location: 434		Breastplate	
Levels		Preservation: poor		Grip	
Slide No.		Neg No:		Hinge	
Description				Bracket	
6-W ADULT TRUNCATED PELVIS DOWN				Fixing nails	
Discussion				Shroud pins	
Shape, dimensions and distinguishing characteristics				Fabric	
LID				Other finds	
HEAD					
BASE					
Recorder: [Signature]		Date: 2/10/00		Initials:	

SITE	COFFIN RECORD SHEET	CONTEXT NO.
OLROO		435
Trench:	Additional sheets:	Treatment:
Site sub-div: NC	Grave fills	BONES COLLECTED
Plan no: 3	Grave cut:	Finds
Section no:	Skeleton:	None
Co-ordinates:	Matrix location: 430 435	Breastplate
Levels	Preservation: 436 BOOK	Grip
Slide No.	Neg No:	Hinge
Description		Bracket
Discussion	6-W NVT	Fixing nails
Shape, dimensions and distinguishing characteristics		Shroud pins
LID		Fabric
HEAD		Other finds
BASE		
Recorder: AHJ	Date: 2/14/00	Initials:

db.

SITE OKR05	COFFIN RECORD SHEET	CONTEXT NO. 436
Trench: d	Additional sheets: 460x1.	Treatment:
Site sub-div: NC	Grave fills	BONES COLLECTED
Plan no: 3	Grave cut:	Finds None
Section no:	Skeleton: 436	Breastplate Grip
Co-ordinates:	Matrix location: 435 436	Hinge Bracket
Levels	Preservation: FAIR	Fixing nails Shroud pins
Slide No.	Neg No:	Fabric Other finds

Description
E-W BURIAL

Discussion

Shape, dimensions and distinguishing characteristics

LID

HEAD

BASE

Recorder: JK	Date: 2/10/00	Initials:
-----------------	------------------	-----------

Outer Coffin

Sample Ret.

Site Code

Context

also

436

Recording Date *27/11/00*

Associated Numbers

Condition

Dep. Plate

Legible

Inscription

Fabric lead ormolou brass tin plated pewter gilt tin
 iron silvered tin enamelled other Sample Ret.

Shape of dep. plate

square rectangle shield tapered lozenge
 cartouche oval other

Upholstery

colour shoddy velvet other Sample Ret.

Construction

butt joint mitred pitched other

Grip plate

Fabric = ormolou brass tin plated pewter gilt tin

iron silvered tin enamelled other *x1* Sample Ret.

Grip

Fabric = ormolou brass iron *x1* Sample Ret.

some do 228(a) & (b)

Design

swag of rose horseshoe cherub's head plain

other

Grip bolts

Corner bolts Type = gilt brass brass iron

other Sample Ret.

Lid motifs

other Sample Ret.

Escutcheons

other Sample Ret.

Upholstery nails

brass gilt brass silvered brass iron enamelled

other Sample Ret.

Fixings

panel nails screws hinges lace Sample Ret.

Timber type

Sample Ret.

Interpretation / Comments

.....

SITE <i>OLR 00</i>		COFFIN RECORD SHEET	CONTEXT NO. 327 <i>437</i>
Trench:	Additional sheets: <i>YES XI</i>	Treatment: <i>Bones collected.</i>	
Site sub-div: <i>NC</i>	Grave fills: <i>—</i>		
Plan no: <i>3</i>	Grave cut: <i>—</i>	Finds None	
Section no:	Skeleton: <i>437</i>	Breastplate Grip	
Co-ordinates:	Matrix location: <i>437</i> <i>438</i>	Hinge Bracket	
Levels	Preservation: <i>GOOD/FAIR.</i>	Fixing nails Shroud pins	
Slide No.	Neg No:	Fabric Other finds	

Description *E-W adult burial on top of 438.*

Discussion

Shape, dimensions and distinguishing characteristics

LID

HEAD

BASE

Recorder: <i>D. Hall</i>	Date: <i>2.10.00</i>	Initials:
--------------------------	----------------------	-----------

Coffin Recording Sheet

Site Code

Context

Outer Coffin

Sample Ret.

02000

437

Recording Date 25/11/00

Associated Numbers

Condition

Dep. Plate

Legible

Inscription

Fabric lead ormolou brass tin plated pewter gilt tin
 iron silvered tin enamelled other Sample Ret.

Shape of dep. plate

square rectangle shield tapered lozenge
 cartouche oval other

Upholstery

colour shoddy velvet other *beize* Sample Ret.

Construction

butt joint mitred pitched other

Grip plate Fabric = ormolou brass tin plated pewter gilt tin
 iron *fastens on rev of grip-wood* silvered tin enamelled other Sample Ret.

Grip Fabric = ormolou brass iron *x3* Sample Ret.

Design swag of rose horseshoe cherub's head *①'s* plain
 other

Grip bolts Corner bolts Type = gilt brass brass iron
 other Sample Ret.

Lid motifs other Sample Ret.

Escutcheons other Sample Ret.

Upholstery ~~nails~~ *studs* brass gilt brass silvered brass iron enamelled
 other *1x price* *800000* *= 7 studs in total* Sample Ret.

Fixings panel nails screws hinges lace Sample Ret.

Timber type Sample Ret.

Interpretation / Comments

.....

.....

db.

SITE		COFFIN RECORD SHEET		CONTEXT NO. 335 438	
Trench:		Additional sheets:	YES x 1.	Treatment:	Bones collected
Site sub-div:	NC	Grave fills	-		
Plan no:	3	Grave cut:	-	Finds	None
Section no:		Skeleton:	438	Breastplate	
Co-ordinates:		Matrix location:	438 437	Hinge	
Levels		Preservation:	Good.	Bracket	
Slide No.		Neg No:		Fixing nails	
				Shroud pins	
				Fabric	
				Other finds	
Description E-W Adult burial underneath 438					
Discussion					
Shape, dimensions and distinguishing characteristics					
LID					
HEAD					
BASE					
Recorder:	D. Hall		Date:	2.10.00	
			Initials:		

Outer Coffin

Sample Ret.

Site Code

Context

Recording Date *22/11*

ORLW

438

Associated Numbers

Condition

Dep. Plate

Legible

Inscription

Fabric lead ormolou brass tin plated pewter gilt tin
iron silvered tin enamelled other Sample Ret.

Shape of dep. plate

square rectangle shield tapered lozenge
cartouche oval other

Upholstery

colour shoddy velvet other Sample Ret.

Construction

butt joint mitred pitched other

Grip plate **Fabric =** ormolou brass tin plated pewter gilt tin
iron silvered tin enamelled other Sample Ret.

Grip **Fabric =** ormolou brass iron Sample Ret.

Design swag of rose horseshoe cherub's head plain

other

Grip bolts **Corner bolts** **Type =** gilt brass brass iron

other Sample Ret.

Lid motifs other Sample Ret.

Escutcheons other Sample Ret.

Upholstery ^{studs} nails brass gilt brass silvered brass iron enamelled
other *1. peice -  = 31 studs in total.* Sample Ret.

Fixings panel nails screws hinges lace Sample Ret.

Timber type Sample Ret.

Interpretation / Comments

.....
.....

SITE <i>OL/00</i>		COFFIN RECORD SHEET	CONTEXT NO. 438 <i>439</i>
Trench:	Additional sheets:	Treatment: <i>BONES COLLECTED</i>	
Site sub-div: <i>NC</i>	Grave fills		
Plan no: <i>3</i>	Grave cut:	Finds None	
Section no:	Skeleton: <i>339</i>	Breastplate Grip	
Co-ordinates:	Matrix location: <i>339</i> <i>440</i>	Hinge Bracket	
Levels	Preservation: <i>FAIR</i>	Fixing nails Shroud pins	
Slide No.	Neg No:	Fabric Other finds	
Description <i>TRUNCATED CHILD CONFUSED WITH 320 OR 324?</i>			
Discussion <i>NEEDS CLARIFYING</i>			
Shape, dimensions and distinguishing characteristics			
LID			
HEAD			
BASE			
Recorder: <i>[Signature]</i>	Date: <i>2/10/00</i>	Initials:	

dp.

SITE 22200	COFFIN RECORD SHEET	CONTEXT NO. 740
Trench:	Additional sheets: YES x 1	Treatment: BONES COLLECTED
Site sub-div: NC	Grave fills	
Plan no: 3	Grave cut:	Finds None
Section no:	Skeleton: 440	Breastplate Grip
Co-ordinates:	Matrix location: 439 440 441	Hinge Bracket
Levels	Preservation: FAIR	Fixing nails Shroud pins
Slide No.	Neg No:	Fabric Other finds

Description
ADULT S-W. POSSIBLE/ STSC 321 OR
Discussion
OTHER IN 320 - 326 REGION

Shape, dimensions and distinguishing characteristics

LID

HEAD

BASE

Recorder: JR	Date: 2/10/00	Initials:
--------------	---------------	-----------

Coffin Recording Sheet

Outer Coffin

Sample Ret.

Site Code

Context

ORL00

440

Recording Date 16/11/06

Associated Numbers

Condition

Dep. Plate

Legible

Inscription

Fabric lead ormolou brass tin plated pewter gilt tin
 iron silvered tin enamelled other Sample Ret.

Shape of dep. plate

square rectangle shield tapered lozenge
 cartouche oval other

Upholstery

colour shoddy velvet other Sample Ret.

Construction

butt joint mitred pitched other

Grip plate Fabric = ormolou brass tin plated pewter gilt tin
 iron silvered tin enamelled other Sample Ret.

Grip Fabric = ormolou brass iron x 2 Sample Ret.

Design swag of rose horseshoe cherub's head plain
 other *conc. w/ fe. up. stud conc. to grip. (A)'s*

Grip bolts **Corner bolts** **Type =** gilt brass brass iron
 other Sample Ret.

Lid motifs other Sample Ret.

Escutcheons other Sample Ret.

Upholstery ^{studs} ~~nails~~ brass gilt brass silvered brass iron x 1 enamelled
 other Sample Ret.

Fixings panel nails screws hinges lace Sample Ret.

Timber type Sample Ret.

Interpretation / Comments

.....

db.

SITE 04-00	COFFIN RECORD SHEET	CONTEXT NO. 441
Trench:	Additional sheets: YES X1	Treatment: BONES COLLECTED
Site sub-div: NC	Grave fills	
Plan no: 3	Grave cut:	Finds None
Section no:	Skeleton: 441	Breastplate Grip
Co-ordinates:	Matrix location: 440 441 1	Hinge Bracket
Levels	Preservation: 442	Fixing nails Shroud pins
Slide No.	Neg No:	Fabric Other finds

Description

ADULT 6-0 POSSIBLY JMSC 322 CR

OTHER IN 320-326 REGION

Discussion

Shape, dimensions and distinguishing characteristics

LID

HEAD

BASE

Recorder: JH

Date: 2/10/00

Initials:

Coffin Recording Sheet

Site Code

Context

OLR00

441

Outer Coffin

Sample Ret.

Recording Date 16/11/00

Associated Numbers

Condition

Dep. Plate

Legible

Inscription

Fabric lead ormolou brass tin plated pewter gilt tin
 iron silvered tin enamelled other Sample Ret.

Shape of dep. plate

square rectangle shield tapered lozenge
 cartouche oval other

Upholstery

colour shoddy velvet other Sample Ret.

Construction

butt joint mitred pitched other

Grip plate Fabric = ormolou brass tin plated pewter gilt tin
 iron silvered tin enamelled other Sample Ret.

Grip Fabric = ormolou brass iron Sample Ret.

Design swag of rose horseshoe cherub's head plain
 other

Grip bolts Corner bolts Type = gilt brass brass iron
 other Sample Ret.

Lid motifs other Sample Ret.

Escutcheons other Sample Ret.

Upholstery ^{studs} ~~nails~~ brass gilt brass silvered brass iron enamelled
 other 2 pieces / 1 x 00 / 1 x 008 Sample Ret.

Fixings panel nails screws hinges lace Sample Ret.

Timber type Sample Ret.

Interpretation / Comments

.....

db.

SITE 02700	COFFIN RECORD SHEET	CONTEXT NO. 442
Trench:	Additional sheets: 443 x 1	Treatment: BONES COLLECTED
Site sub-div: NC	Grave fills	
Plan no: 3	Grave cut:	Finds None
Section no:	Skeleton: 442	Breastplate Grip
Co-ordinates:	Matrix location: 441 442	Hinge Bracket
Levels	Preservation: 444	Fixing nails Shroud pins
Slide No.	Neg No:	Fabric Other finds

Description
MULT G-W POSSIBLY BURIAL IN 320-326

Discussion
RANGE

Shape, dimensions and distinguishing characteristics

LID

HEAD

BASE

Recorder: JRW	Date: 7/10/00	Initials:
---------------	---------------	-----------

Coffin Recording Sheet

Site Code

Context

01200

442

Outer Coffin

Sample Ret.

Recording Date 27/00

Associated Numbers

Condition

Dep. Plate

Legible

Inscription

Fabric lead ormolou brass tin plated pewter gilt tin
 iron silvered tin enamelled other Sample Ret.

Shape of dep. plate

square rectangle shield tapered lozenge
 cartouche oval other

Upholstery

colour shoddy velvet other Sample Ret.

Construction

butt joint mitred pitched other

Grip plate

Fabric = ormolou brass tin plated pewter gilt tin
 iron silvered tin enamelled other Sample Ret.

frags on rev of grip - unid.

Grip

Fabric = ormolou brass iron x 5 Sample Ret.

Design

swag of rose horseshoe cherub's head *conc 415* plain
 other

Grip bolts

Corner bolts Type = gilt brass brass iron

other Sample Ret.

Lid motifs

other Sample Ret.

Escutcheons

other Sample Ret.

Upholstery nails

brass gilt brass silvered brass iron enamelled

other Sample Ret.

Fixings

panel nails screws hinges lace Sample Ret.

Timber type

..... Sample Ret.

Interpretation / Comments

.....

SITE		COFFIN RECORD SHEET		CONTEXT NO. 443	
Trench: OLR 00		Additional sheets:		Treatment: Bones collected.	
Site sub-div: NC		Grave fills: /			
Plan no: 3		Grave cut: /		Finds	
Section no:		Skeleton: 443		None	
Co-ordinates:		Matrix location: 443 1 443		Breastplate	
Levels:		Preservation: Good.		Grip	
Slide No.:		Neg No.:		Hinge	
Description		E-W sheld of Neonate, v.v. small. Fair retrieval rate.		Bracket	
Discussion				Fixing nails	
Shape, dimensions and distinguishing characteristics				Shroud pins	
LID				Fabric	
HEAD				Other finds	
BASE					
Recorder: D. Ham		Date: 2.10.00		Initials:	

SITE	COFFIN RECORD SHEET	CONTEXT NO.
04R00	Additional sheets:	444
Trench:	Grave fills	Treatment: BONES COLLECTED
Site sub-div: NC	Grave cut:	Finds
Plan no: 3	Skeleton:	None
Section no:	444	Breastplate
Co-ordinates:	Matrix location: 442	Grip
	444	Hinge
Levels	Preservation: FAIR	Bracket
Slide No.	Neg No:	Fixing nails
		Shroud pins
		Fabric
		Other finds
Description 6W BABY		
Discussion		
Shape, dimensions and distinguishing characteristics		
LID		
HEAD		
BASE		
Recorder: JKW	Date: 2/10/00	Initials:

db.

SITE 2LR00	COFFIN RECORD SHEET	CONTEXT NO. 445
Trench:	Additional sheets: YES x1	Treatment: BUNGS COLLECTED
Site sub-div: NC	Grave fills	
Plan no: 3	Grave cut:	Finds None
Section no:	Skeleton: 445	Breastplate Grip
Co-ordinates:	Matrix location: 443 445	Hinge Bracket
Levels	Preservation: 446 GOOD 447	Fixing nails Shroud pins
Slide No.	Neg No:	Fabric Other finds

Description
G-W ADULT MACHINED OUT

Discussion

Shape, dimensions and distinguishing characteristics

LID

HEAD

BASE

Recorder: JR	Date: 2/10/00	Initials:
--------------	---------------	-----------

Coffin Recording Sheet

Outer Coffin

Sample Ret.

Site Code

Context

Recording Date 15/11/00

OLR00

445

Associated Numbers

Condition

Dep. Plate

Legible

Inscription

Fabric lead ormolou brass tin plated pewter gilt tin
iron silvered tin enamelled other Sample Ret.

Shape of dep. plate

square rectangle shield tapered lozenge
cartouche oval other

Upholstery

colour shoddy velvet other Sample Ret.

Construction butt joint mitred pitched other

Grip plate **Fabric =** ormolou brass tin plated pewter gilt tin
iron silvered tin enamelled other Sample Ret.

Grip **Fabric =** ormolou brass iron ^{X1} Sample Ret.

Design swag of rose horseshoe cherub's head (A) plain
other

Grip bolts **Corner bolts** **Type =** gilt brass brass iron
other Sample Ret.

Lid motifs other Sample Ret.

Escutcheons other Sample Ret.

Upholstery nails brass gilt brass silvered brass iron enamelled
other Sample Ret.

Fixings panel nails screws hinges lace Sample Ret.

Timber type Sample Ret.

Interpretation / Comments

.....
.....

db

SITE OLR00	COFFIN RECORD SHEET	CONTEXT NO. 446
Trench:	Additional sheets: YES x 2.	Treatment:
Site sub-div: NC	Grave fills	BONES COLLECTED
Plan no: 3	Grave cut:	Finds None
Section no:	Skeleton: 446	Breastplate Grip
Co-ordinates:	Matrix location: 445 446 ? 447 448	Hinge Bracket
Levels	Preservation: GOOD	Fixing nails Shroud pins
Slide No.	Neg No:	Fabric Other finds

Description
S-W ADULT MACHINED OUT DUE TO DEPTH
NOT SURE RELATIONSHIP WITH 447 (MIXING WITH
Discussion 447a 448)

Shape, dimensions and distinguishing characteristics

LID

HEAD

BASE

Recorder: JW	Date: 3/10/00	Initials:
--------------	---------------	-----------

Coffin Recording Sheet

Site Code

Context

Outer Coffin

Sample Ret.

02200

446

Recording Date 27/1/00

Associated Numbers

Condition 2

Dep. Plate

Legible ISH

Inscription " ? / Rebecca ? / Died 16th June / 185 ? / Aged 79 years "

Fabric lead ormolou brass tin plated pewter gilt tin
iron silvered tin enamelled other Sample Ret.

Shape of dep. plate

square rectangle shield tapered lozenge
cartouche oval other *new type.*

Upholstery

colour shoddy velvet other Sample Ret.

Construction

butt joint mitred pitched other

Grip plate Fabric = ormolou brass tin plated pewter gilt tin
iron silvered tin enamelled other Sample Ret.

Grip Fabric = ormolou brass iron Sample Ret.

Design swag of rose horseshoe cherub's head plain
other

Grip bolts **Corner bolts** **Type =** gilt brass brass iron
other Sample Ret.

Lid motifs other Sample Ret.

Escutcheons other Sample Ret.

Upholstery nails brass gilt brass silvered brass iron enamelled
other Sample Ret.

Fixings panel nails screws hinges lace Sample Ret.

Timber type Sample Ret.

Interpretation / Comments

.....
.....

SITE		COFFIN RECORD SHEET		CONTEXT NO.	
0200				447	
Trench:		Additional sheets: 465x2. 77		Treatment:	
Site sub-div: NC		Grave fills		BONES COLLECTED	
Plan no: 3		Grave cut:		Finds	
Section no:		Skeleton: 447		None	
Co-ordinates:		Matrix location: 445 447? 446 448		Breastplate	
Levels		Preservation: good		Grip	
Slide No.		Neg No:		Hinge	
				Bracket	
				Fixing nails	
				Shroud pins	
				Fabric	
				Other finds	

Description
 6-W ADULT MACHINED OUT, NOT SURE OF RELATIONSHIP WITH 446

Discussion
 MIXED WITH 446 & 448

Shape, dimensions and distinguishing characteristics

LID

HEAD

BASE

Recorder: JH	Date: 3/10/00	Initials:
--------------	---------------	-----------

SITE 0100	COFFIN RECORD SHEET	CONTEXT NO. 448
Trench:	Additional sheets:	Treatment: BONE COLLECTED
Site sub-div: WC	Grave fills	
Plan no: 3	Grave cut:	Finds None
Section no:	Skeleton: 448	Breastplate Grip
Co-ordinates:	Matrix location: 446 447 LJ 448	Hinge Bracket
Levels	Preservation:	Fixing nails Shroud pins
Slide No.	Neg No:	Fabric Other finds
<p>Description S-W ADULT MACHINED OUT, 446 447 MIXED WITH 446, 447</p> <p>Discussion</p>		
<p>Shape, dimensions and distinguishing characteristics</p> <p>LID</p> <p>HEAD</p> <p>BASE</p>		
Recorder: JH	Date: 3/10/00	Initials:

dp

SITE 06200	COFFIN RECORD SHEET	CONTEXT NO. 449
Trench:	Additional sheets: 95 x 2	Treatment: BONES COLLECTED
Site sub-div: NC	Grave fills	DNA SAMPLE
Plan no: 3	Grave cut:	Finds
Section no:	Skeleton: 449	None
Co-ordinates:	Matrix location:	Breastplate ✓
Levels	Preservation: poor	Grip
Slide No.	Neg No:	Hinge
		Bracket
		Fixing nails
		Shroud pins
		Fabric
		Other finds

Description
ADULT BURIAL IN NAMED LEAD COFFIN
V. DECAYED.

Discussion
D.N.A. d.

Shape, dimensions and distinguishing characteristics

LID

HEAD

BASE

Recorder: [Signature]	Date: 3/10/00	Initials:
-----------------------	---------------	-----------

Coffin Recording Sheet

Site Code

Context

OR00

449

Outer Coffin

Sample Ret.

Recording Date 17/11/00

Associated Numbers

Condition 3

Dep. Plate

Legible

Inscription "George Jeffreys/Died 18th March/1804/Aged 56 Yrs"
some as 362 w/ (86) border except in script edges.

Fabric lead ormolou brass tin plated pewter gilt tin
 iron silvered tin enamelled other Sample Ret.

Shape of dep. plate

square rectangle shield tapered lozenge
 cartouche oval other

Upholstery

colour shoddy velvet other Sample Ret.

Construction

butt joint mitred pitched other

Grip plate

Fabric = ormolou brass tin plated pewter gilt tin
 iron silvered tin enamelled other Sample Ret.

Grip

Fabric = ormolou brass iron Sample Ret.

Design

swag of rose horseshoe cherub's head plain
 other

Grip bolts

Corner bolts Type = gilt brass brass iron
 other Sample Ret.

Lid motifs

other Sample Ret.

Escutcheons

other Sample Ret.

Upholstery nails

brass gilt brass silvered brass iron enamelled
 other Sample Ret.

Fixings

panel nails screws hinges lace Sample Ret.

Timber type

Sample Ret.

Interpretation / Comments

.....

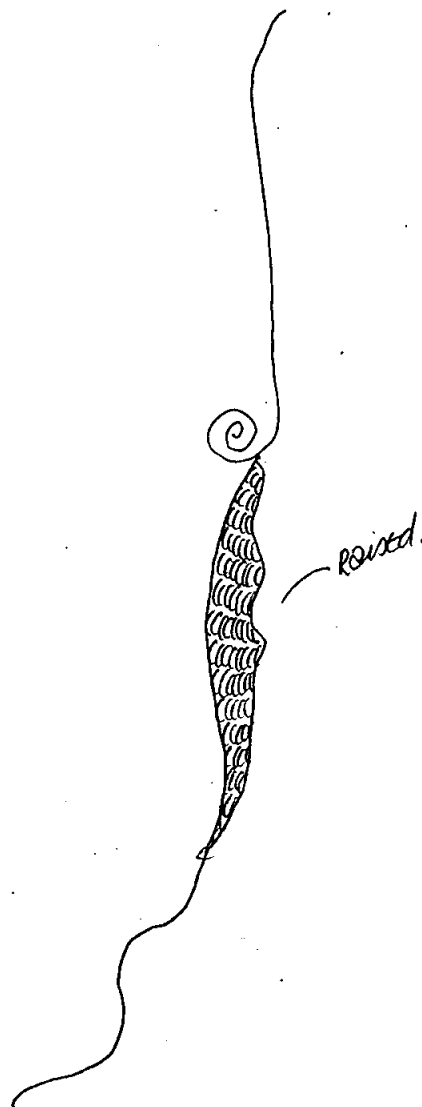
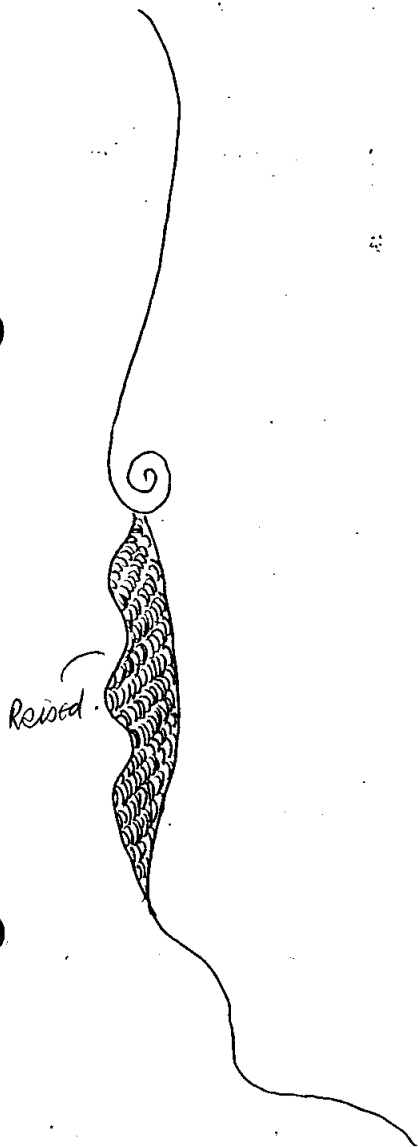

db

SITE	OLR 00	COFFIN RECORD SHEET	CONTEXT NO.	450
Trench:		Additional sheets:	YES X1	
Site sub-div:	NC	Grave fills	-	
Plan no:	3.	Grave cut:	-	
Section no:		Skeleton:	450	
Co-ordinates:		Matrix location:	<div style="border: 1px solid black; padding: 2px; display: inline-block;">449</div> <div style="border: 1px solid black; padding: 2px; display: inline-block;">450</div>	
Levels		Preservation:	Good.	
Slide No.		Neg No:		
Description		E-W Adult burial in lead Coffin, very messy, underlying 449.		
Discussion				
Shape, dimensions and distinguishing characteristics				
LID				
HEAD				
BASE				
Recorder:	D. Ham	Date:	3-9-00	
			Initials:	

Site Code

Context

Outer Coffin

Sample Ret.

0h200

450

Recording Date 17/11/00

Associated Numbers

Condition 2

Dep. Plate

Legible ish.

Inscription "Mr & Mrs Sarah Jeffreys / Died 23rd Sept / 1797 / Aged 52 Y^{rs}"
some do 362 w/ 36 inner border & 621 outer border.

Fabric lead ormolou brass tin plated pewter gilt tin
 iron silvered tin enamelled other Sample Ret.

black polished.

Shape of dep. plate

square rectangle shield tapered lozenge
 cartouche oval other

Upholstery

colour shoddy velvet other Sample Ret.

Construction

butt joint mitred pitched other

Grip plate

Fabric = ormolou brass tin plated pewter gilt tin

iron silvered tin enamelled other Sample Ret.

Grip

Fabric = ormolou brass iron Sample Ret.

Design

swag of rose horseshoe cherub's head plain

other

Grip bolts

Corner bolts Type = gilt brass brass iron

other Sample Ret.

Lid motifs

other Sample Ret.

Escutcheons

other Sample Ret.

Upholstery nails

brass gilt brass silvered brass iron enamelled

other Sample Ret.

Fixings

panel nails screws hinges lace Sample Ret.

Timber type

Sample Ret.

Interpretation / Comments

.....

SITE	COFFIN RECORD SHEET		CONTEXT NO.
Trench:	Additional sheets:	Treatment: <i>Bones collected.</i>	
Site sub-div: <i>NC</i>	Grave fills: <i>-</i>		
Plan no: <i>3</i>	Grave cut: <i>-</i>	Finds None	
Section no:	Skeleton: <i>451</i>	Breastplate ✓ - <i>DAMAGED</i> . Grip	
Co-ordinates:	Matrix location:	Hinge Bracket	
Levels	Preservation: <i>FAIR</i> .	Fixing nails Shroud pins	
Slide No.	Neg No:	Fabric Other finds	
<p>Description <i>E-W adult, truncated on S. side (right side of body) due to modern disturbance - found out by presence of sweet wrappers in area.</i></p>			
<p>Discussion</p>			
<p>Shape, dimensions and distinguishing characteristics</p> <p>LID</p> <p>HEAD</p> <p>BASE</p>			
Recorder: <i>A. Hall</i>	Date: <i>3-9-00.</i>	Initials:	

db

SITE OLROO	COFFIN RECORD SHEET	CONTEXT NO. 452
Trench:	Additional sheets: YES x1	Treatment:
Site sub-div: NC	Grave fills	BONES COLLECTED
Plan no: 3	Grave cut:	Finds
Section no:	Skeleton:	None
Co-ordinates:	Matrix location:	Breastplate
Levels	Preservation:	Grip
Slide No.	Neg No:	Hinge
		Bracket
		Fixing nails
		Shroud pins
		Fabric
		Other finds
Description	MACHINED WITH TOOTH BURST, LOWER HALF RETRIEVED BY HAND	
Discussion	G-W MCT	
Shape, dimensions and distinguishing characteristics		
LID		
HEAD		
BASE		
Recorder: JH	Date: 3/10/00	Initials:

Coffin Recording Sheet

Site Code

Context

Outer Coffin

Sample Ret.

02R00

452

Recording Date 22/11

Associated Numbers

Condition

Dep. Plate

Legible

Inscription

Fabric lead ormolou brass tin plated pewter gilt tin
 iron silvered tin enamelled other Sample Ret.

Shape of dep. plate

square rectangle shield tapered lozenge
 cartouche oval other

Upholstery

colour shoddy velvet other Sample Ret.

Construction

butt joint mitred pitched other

Grip plate Fabric = ormolou brass tin plated pewter gilt tin
 iron silvered tin enamelled other Sample Ret.

feags on ew of grip

Grip Fabric = ormolou brass iron *X1* Sample Ret.

Design

swag of rose horseshoe cherub's head plain

other *too conc. to id*

Grip bolts Corner bolts Type = gilt brass brass iron

other Sample Ret.

Lid motifs other Sample Ret.

Escutcheons other Sample Ret.

Upholstery ~~nails~~ *studs* brass gilt brass silvered brass iron enamelled

other *1x00 / 1x0800 = total of 7 studs, 2 pieces* Sample Ret.

Fixings panel nails screws hinges lace Sample Ret.

Timber type Sample Ret.

Interpretation / Comments

.....

db.

SITE 04200		COFFIN RECORD SHEET		CONTEXT NO. 453	
Trench:		Additional sheets: YES x 2.		Treatment:	
Site sub-div: NC		Grave fills		BONES COLLECTED	
Plan no: 3		Grave cut:		Finds	
Section no:		Skeleton: 453		None	
Co-ordinates:		Matrix location: 453 454		Breastplate LEAD	
Levels		Preservation: FAIR		Grip IN	
Slide No.		Neg No:		Hinge	
Description		LEAD COFFIN 6-W ADULT IN VAULT 456		Bracket VAULT	
Discussion				Fixing nails 456	
Shape, dimensions and distinguishing characteristics				Shroud pins	
LID				Fabric	
HEAD				Other finds	
BASE					
Recorder: [Signature]		Date: 4/10/00		Initials:	

Outer Coffin

Sample Ret.

Site Code

Context

OR00

453

Recording Date 20/11/00

Associated Numbers 454

Condition 3

Dep. Plate

Legible

Inscription "Mr/Benjamin Smith/Died 8th July/1764/In his 58th year"
new type see sheet.

Fabric lead ormolou brass tin plated pewter gilt tin
 iron silvered tin enamelled other Sample Ret.

Shape of dep. plate

square rectangle shield tapered lozenge
 cartouche oval other

Upholstery

colour shoddy velvet other Sample Ret.

Construction

butt joint mitred pitched other

Grip plate Fabric = ormolou brass tin plated pewter gilt tin
 iron silvered tin enamelled other Sample Ret.

Grip Fabric = ormolou brass iron Sample Ret.

Design swag of rose horseshoe cherub's head plain
 other

Grip bolts Corner bolts Type = gilt brass brass iron
 other Sample Ret.

Lid motifs other Sample Ret.

Escutcheons other Sample Ret.

Upholstery nails brass gilt brass silvered brass iron enamelled
 other Sample Ret.

Fixings panel nails screws hinges lace Sample Ret.

Timber type Sample Ret.

Interpretation / Comments

.....

SITE 02200	COFFIN RECORD SHEET	CONTEXT NO. 454
Trench:	Additional sheets: YES x 2.	Treatment:
Site sub-div: NC	Grave fills	BONE COLLECTED
Plan no: 3	Grave cut:	Finds
Section no:	Skeleton: 454	None
Co-ordinates:	Matrix location: 453 454	Breastplate LEAD
Levels	Preservation: POOR - FAIR	Grip IN
Slide No.	Neg No:	Hinge VAULT
		Bracket
		Fixing nails 456
		Shroud pins
		Fabric
		Other finds

Description **LEAD COFFIN 6-W ADULT. MACHINED OUT WITH TOOTHED BUCKET. IN VAULT (BRICK GRAB) 456**

Discussion

Shape, dimensions and distinguishing characteristics

LID

HEAD

BASE

Recorder: Jhr	Date: 4/10/00	Initials:
----------------------	----------------------	-----------

Coffin Recording Sheet

Site Code

Context

OK200

45A

Outer Coffin

Sample Ret.

Recording Date 20/11/00

Associated Numbers

Condition 1

Dep. Plate X2

Legible - NO(SH)

Inscription

*(Smith?)
"Mrs/Elizth ... nith/Died June/1755/In her A... Year/Of her life"
new type see sheet.*

Fabric lead

ormolou

brass

tin plated pewter

gilt tin

iron

silvered tin

enamelled

other

Sample Ret.

Shape of dep. plate

square

rectangle

shield

tapered

lozenge

cartouche

oval

other

Upholstery

colour

shoddy

velvet

other

Sample Ret.

Construction

butt joint

mitred

pitched

other

Grip plate

Fabric = ormolou

brass

tin plated pewter

gilt tin

iron

silvered tin

enamelled

other

Sample Ret.

Grip

Fabric = ormolou

brass

iron

Sample Ret.

Design

swag of rose

horseshoe

cherub's head

plain

other

Grip bolts

Corner bolts

Type = gilt brass

brass

iron

other Sample Ret.

Lid motifs

other Sample Ret.

Escutcheons

other Sample Ret.

Upholstery nails

brass

gilt brass

silvered brass

iron

enamelled

other Sample Ret.

Fixings

panel nails

screws

hinges

lace

Sample Ret.

Timber type

Sample Ret.

Interpretation / Comments

.....
.....

SITE	COFFIN RECORD SHEET	CONTEXT NO.
OL100	Additional sheets:	455
Trench:	Grave fills	Treatment: BUNG COLLECTED
Site sub-div: NC	Grave cut:	Finds
Plan no: 3	Skeleton: 455	None
Section no:	Matrix location:	Breastplate
Co-ordinates:	Preservation: GOOD	Grip
Levels	Neg No:	Hinge
Slide No:	Discussion	Bracket
<p>Description LOWER LEGS OF E-W BURIAL TRUNCATED AND EXCAVATED WITH TOOTHED BUCKET</p>		
<p>Shape, dimensions and distinguishing characteristics</p> <p>LID</p> <p>HEAD</p> <p>BASE</p>		
Recorder:	Date:	Initials:
JLW	20/10/00	

SITE OLR 00		CONTEXT RECORD		Context No. 456
		Additional Sheets:		Type STRUCTURE
Trench	Context Type: Deposit / Cut / Structure		Check Lists:	
Site sub-div NC	Overlain by:		DEPOSIT:	
Structure No. 456	Abutted by:		1.compaction 2.colour 3.composition 4.inclusions 5.thickness 6.extent 7.comments 8.method & conditions	
Plan No. 3	Cut by:		CUT: 1.shape in plan 2.base/sides/top profile 3.dimension and depth 4.sketch 5.truncation 6.fill nos 7.other comments	
	Part of: CONTAINS BURIALS 453 + 454.			
Section No.	Same as:		MASONRY: 1.materials 2.size of bricks etc 3.finish of stones 4.coursing/bond 5.form 6.faces 7.bond 8.dimensions as found 9.other comments	
	Part of:			
Co-Ordinates	Consists of:			
	Overlies:			
Level	Butts:			
Slide No.	Cuts:			
Neg No.	Fill of:			
Matrix location	Relationships uncertain			

Description (See check lists):

- ① Red Brck.
- ② 0.22m x 0.11 x 0.07m.
- ③ /
- ④ UNKNOWN.
- ⑤ BRICK GRAVE
- ⑥ NOT FACED.
- ⑦ SOFT, GREY, LIMY
- ⑧ 1.5m (W) x 2.30m (L) x c 2m (D) ⑨ INTERIOR OF BRICK GRAVE

STRATIGRAPHIC MATRIX

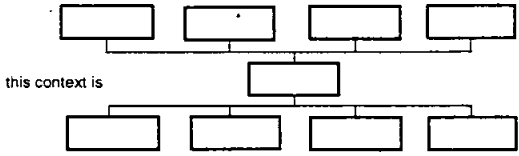

Interpretation/Discussion:

FAMILY (?) BRICK VAULT/GRAVE IN N. CHURCHYARD, CLOSE TO CHURCH WALL.
THINNER, REDDER BRICKS ON DIFFERENT ALIGNMENT AT BOTTOM APPEAR TO MAKE SOME KIND OF FOUNDATION.

Finds (tick): None Pot Bone Flint Stone Burnt stone Glass Metal
CBM Wood Leather

△ Small Finds	Recorder Off
◇ Samples	Date 4.10.08
△ Building Materials	Initials

SITE	COFFIN RECORD SHEET	CONTEXT NO.
02R 50		457
Trench:	Additional sheets:	Treatment: <i>Bones collected.</i>
Site sub-div: <i>NC</i>	Grave fills <i>-</i>	
Plan no: <i>3</i>	Grave cut: <i>-</i>	Finds <i>None</i>
Section no:	Skeleton: <i>457</i>	Breastplate Grip
Co-ordinates:	Matrix location: <i>457 - Truncates 459.</i> <i>459</i> <i>458</i>	Hinge Bracket
Levels	Preservation: <i>Fair.</i>	Fixing nails Shroud pins
Slide No.	Neg No:	Fabric Other finds
Description <i>E-W Adult burial. Head lying on upper body of 459. Possibly some truncation from building of wall to the south. Also truncates 459.</i>		
Discussion		
Shape, dimensions and distinguishing characteristics LID HEAD BASE		
Recorder: <i>D. Hall</i>	Date: <i>4.9.10.00.</i>	Initials:

SITE	COLR 00	COFFIN RECORD SHEET	CONTEXT NO.	458
Trench:		Additional sheets:	Treatment: Bones collected.	
Site sub-div:	NC	Grave fills	/	
Plan no:	3	Grave cut:	/	
Section no:		Skeleton:	458	
Co-ordinates:		Matrix location:	457 459 458	
Levels		Preservation:	GOOD.	
Slide No.		Neg No:		
		Finds		None
		Breastplate		
		Grip		
		Hinge		
		Bracket		
		Fixing nails		
		Shroud pins		
		Fabric		
		Other finds		:

Description E-W Adult, underlying 459, which was truncated away by 457. Possible truncation by vault to South.

Discussion

Shape, dimensions and distinguishing characteristics

LID

HEAD

BASE

Recorder:	D. H. W.	Date:	4.10.00	Initials:	
-----------	----------	-------	---------	-----------	--

SITE	COFFIN RECORD SHEET	CONTEXT NO.
OLR 00		457 459.
Trench:	Additional sheets:	Treatment: Bones collected.
Site sub-div: NC	Grave fills /	
Plan no: 3	Grave cut: /	Finds None
Section no:	Skeleton: 459	Breastplate Grip
Co-ordinates:	Matrix location: 457 459 - Truncated by 457 458	Hinge Bracket
Levels	Preservation: Poor.	Fixing nails Shroud pins
Slide No.	Neg No:	Fabric Other finds
<p>Description E-W adult burial truncated by 457, only head + neck surviving. Also possibly truncated by vault to the south.</p> <p>Discussion</p>		
<p>Shape, dimensions and distinguishing characteristics</p> <p>LID</p> <p>HEAD</p> <p>BASE</p>		
Recorder: [Signature]	Date: 4/10/02	Initials:

dp.

SITE OLR06		COFFIN RECORD SHEET		CONTEXT NO. 460	
Trench:		Additional sheets: YES x 1		Treatment: BONES COLLECTED	
Site sub-div: NC		Grave fills			
Plan no: 3		Grave cut: FROM BRICK GRAVE 3		Finds None	
Section no:		Skeleton: 460		Breastplate Grip	
Co-ordinates:		Matrix location: 460 1 461		Hinge Bracket	
Levels		Preservation: GOOD		Fixing nails Shroud pins	
Slide No.		Neg No:		Fabric Other finds	
<p>Description BRICK GRAB '3' LEFT OPEN FOR A FEW WEEKS, CONTAINING WHAT SEEMED TO BE AT LEAST 3 INDIVIDUALS ALL AS CHARNAL EXCEPT ARTICULATED SKULL AND NECK. TAKEN OUT WITH TOOTHED BUCKET.</p> <p>Discussion SUPPOSED TO CONTAIN 1 INDIVIDUAL ON BRICK FLOOR WHICH WAS NOT SEEN</p>					
<p>Shape, dimensions and distinguishing characteristics</p> <p>LID</p> <p>HEAD</p> <p>BASE</p>					
Recorder: JW		Date: 4/10/00		Initials:	

Coffin Recording Sheet

Site Code

Context

Outer Coffin

Sample Ret.

04400

460

Recording Date *15/11/00*

Associated Numbers

Condition

Dep. Plate

Legible

Inscription

Fabric lead ormolou brass tin plated pewter gilt tin
 iron silvered tin enamelled other Sample Ret.

Shape of dep. plate

square rectangle shield tapered lozenge
 cartouche oval other

Upholstery

colour shoddy velvet other Sample Ret.

Construction

butt joint mitred pitched other

Grip plate Fabric = ormolou brass tin plated pewter gilt tin
 iron silvered tin enamelled other Sample Ret.

Flags on REV. of grip.

Grip Fabric = ormolou brass iron *x1* Sample Ret.

Design

swag of rose horseshoe cherub's head plain

too conc. to id.

other

Grip bolts Corner bolts Type = gilt brass brass iron

other Sample Ret.

Lid motifs other Sample Ret.

Escutcheons other Sample Ret.

Upholstery nails brass gilt brass silvered brass iron enamelled

other Sample Ret.

Fixings panel nails screws hinges lace Sample Ret.

Timber type Sample Ret.

Interpretation / Comments

.....

SITE		COFFIN RECORD SHEET	CONTEXT NO. 461
Trench: 0LR06	Additional sheets:	Treatment:	
Site sub-div: NC	Grave fills	BONES COLLECTED	
Plan no: 3	Grave cut: FROM BRICE STREET B	Finds	
Section no:	Skeleton: 461	None	
Co-ordinates:	Matrix location: 460 461	Breastplate	
Levels	Preservation: V. GOOD	Grip	
Slide No.	Neg No:	Hinge	
Description		Bracket	
Discussion		Fixing nails	
Shape, dimensions and distinguishing characteristics		Shroud pins	
LID		Fabric	
HEAD		Other finds	
BASE			
Recorder: JW	Date: 4/10/00	Initials:	

Outer Coffin

Sample Ret.

Site Code

Context

Recording Date *16/11/00*

04200

462

Associated Numbers

Condition

Dep. Plate

Legible

Inscription

Fabric lead ormolou brass tin plated pewter gilt tin
 iron silvered tin enamelled other Sample Ret.

Shape of dep. plate

square rectangle shield tapered lozenge
 cartouche oval other

Upholstery

colour shoddy velvet other Sample Ret.

Construction

butt joint mitred pitched other

Grip plate Fabric = ormolou brass tin plated pewter gilt tin
 iron silvered tin enamelled other Sample Ret.

frag on REV of grip - unid.

Grip Fabric = ormolou brass iron *x1* Sample Ret.

Design swag of rose horseshoe cherub's head plain
 other *too conc. to id.*

Grip bolts Corner bolts Type = gilt brass brass iron
 other Sample Ret.

Lid motifs other Sample Ret.

Escutcheons other Sample Ret.

Upholstery nails brass gilt brass silvered brass iron enamelled
 other Sample Ret.

Fixings panel nails screws hinges lace Sample Ret.

Timber type Sample Ret.

Interpretation / Comments

.....

db

SITE OLR 00	COFFIN RECORD SHEET	CONTEXT NO. 463
Trench:	Additional sheets: YES x 1	Treatment: Bones collected.
Site sub-div: NC	Grave fills: -	
Plan no: 3	Grave cut: -	Finds None
Section no:	Skeleton: 463	Breastplate Grip
Co-ordinates:	Matrix location: 462 462 463 463 498 498	Hinge Bracket
Levels	Preservation: GOOD.	Fixing nails Shroud pins
Slide No.	Neg No:	Fabric Other finds
Description E-W young adult burial. Directly below 462 and directly above 498 498 Discussion Shape, dimensions and distinguishing characteristics LID HEAD BASE		
Recorder: D. Hall	Date: 5-10-00	Initials:

Coffin Recording Sheet

Site Code

Context

Outer Coffin

Sample Ret.

Ohloo

463

Recording Date 11/10

Associated Numbers

Condition

Dep. Plate

Legible

Inscription

Fabric lead ormolou brass tin plated pewter gilt tin
 iron silvered tin enamelled other Sample Ret.

Shape of dep. plate

square rectangle shield tapered lozenge
 cartouche oval other

Upholstery

colour shoddy velvet other Sample Ret.

Construction

butt joint mitred pitched other

Grip plate Fabric = ormolou brass tin plated pewter gilt tin
 iron silvered tin enamelled other Sample Ret.
flugs on rev. of grip

Grip Fabric = ormolou brass iron x2 Sample Ret.

Design

swag of rose horseshoe cherub's head plain

other *body conc. unid #*

Grip bolts Corner bolts Type = gilt brass brass iron

other Sample Ret.

Lid motifs other Sample Ret.

Escutcheons other Sample Ret.

Upholstery nails brass gilt brass silvered brass iron enamelled

other Sample Ret.

Fixings panel nails screws hinges lace Sample Ret.

Timber type Sample Ret.

Interpretation / Comments

.....

SITE	COFFIN RECORD SHEET	CONTEXT NO.
OLROO		465
Trench: CRUPT	Additional sheets:	Treatment: INTERACT
Site sub-div:	Grave fills	NO NAME
Plan no: 7	Grave cut:	Finds
Section no:	Skeleton:	None
Co-ordinates:	Matrix location: OVER 36A in vault 16.	Breastplate
Levels	Preservation: 4	Grip
Slide No.	Neg No:	Hinge
		Bracket
		Fixing nails
		Shroud pins
		Fabric
		Other finds:

Description infant p.b. coffin.

Discussion

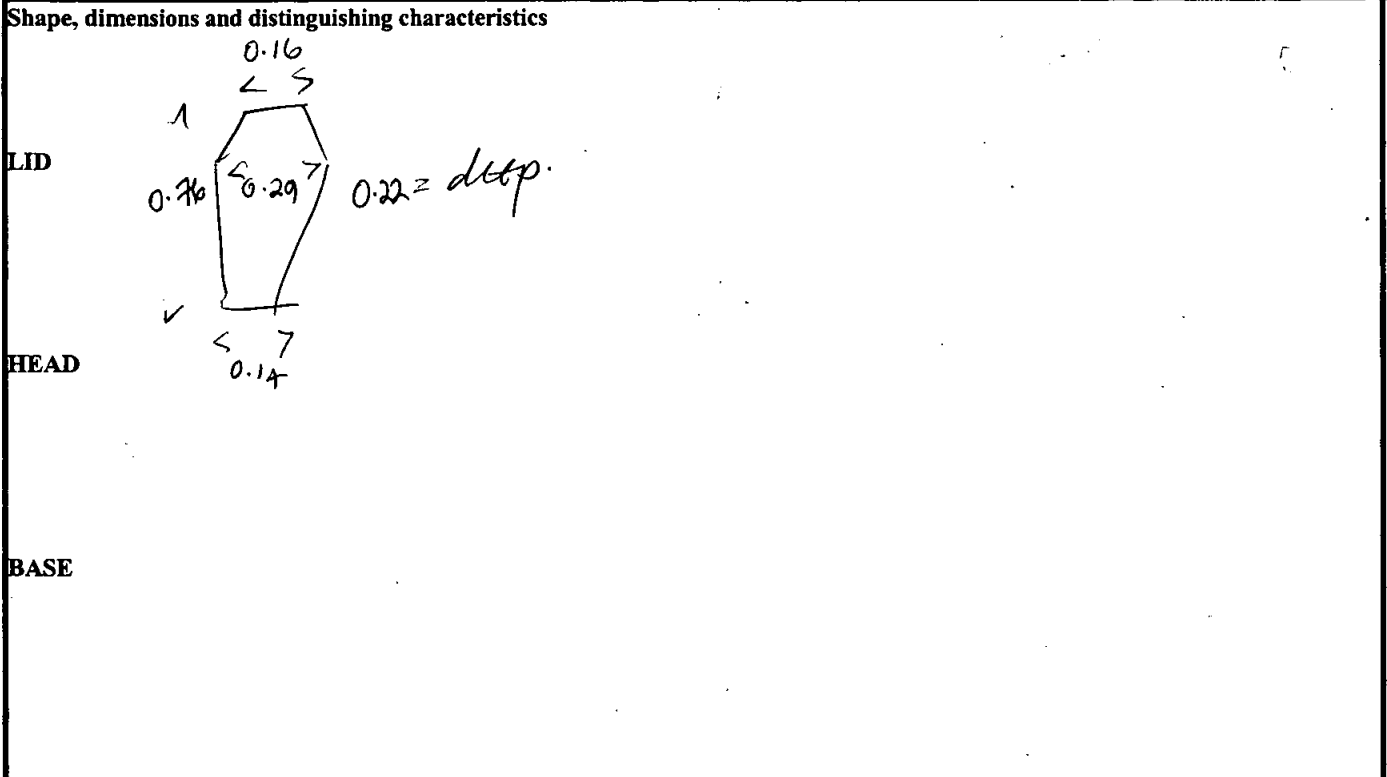

Recorder:	Date:	Initials:
-----------	-------	-----------

db

SITE	COFFIN RECORD SHEET	CONTEXT NO.
01R00		466
Trench: CRYPT	Additional sheets:	Treatment: INTACT. NOT OPENED
Site sub-div:	Grave fills	
Plan no:	Grave cut:	Finds
		None dop plate (plain) [2] Breastplate x2 p.b. [b] Grip x 1 frog-fe. conc.
Section no:	Skeleton:	Hinge
		Bracket
Co-ordinates:	Matrix location: over 364 in vault 16	Fixing nails
Levels	Preservation:	Shroud pins
Slide No.	Neg No:	Fabric
		Other finds

Description mfgmt p.b. coffins

Discussion

Shape, dimensions and distinguishing characteristics

LID

HEAD

BASE

0.22. = deep.

②

"Master Thos Hathorn died 21st Augst 1806 Aged 9 Mon^{ths} & 4 Days"

③ is squashed in spoil of base of vault & is a spltdo ④

a Master Thos Hathornst Died 21st Augst 1806 Aged 9 Mon^{ths} & 4 Days"

Recorder: _____ Date: _____ Initials: _____

2/6

SITE OLR00	COFFIN RECORD SHEET	CONTEXT NO. 467.
Trench: CRMPT	Additional sheets:	Treatment: skully lifted & DNA taken
Site sub-div:	Grave fills	
Plan no: 7	Grave cut:	Finds None w. 2 pb. @
Section no:	Skeleton:	Breastplate + inscrip. Grip
Co-ordinates:	Matrix location: Bay 3/4. (w. end)	Hinge Bracket
Levels	Preservation:	Fixing nails Shroud pins
Slide No.	Neg No:	Fabric Other finds

Description
skull p.b. coffin

Discussion
~~wooden coffin~~ ~~top feet~~ ~~skull~~ ~~inscrip.~~ ~~breastplate~~ ~~grip~~ ~~hinge~~ ~~bracket~~ ~~fixing nails~~ ~~shroud pins~~ ~~fabric~~ ~~other finds~~

Shape, dimensions and distinguishing characteristics

LID
0.26
0.77
0.50
0.35 = deep inscrip.
MK

HEAD
John Cotton Pugh
Died 6th July
1829
Aged 22 yrs.
stamp

BASE
0.12

0.15
Bot?
0.18

John Cotton Pugh
July 1829

Recorder: _____ Date: _____ Initials: _____

db

SITE 02LR00	COFFIN RECORD SHEET	CONTEXT NO. 468
Trench: CRYPT	Additional sheets:	Treatment: Skelly lifted & DNA taken.
Site sub-div:	Grave fills	
Plan no: 7	Grave cut:	Finds None
Section no:	Skeleton:	Breastplate - x1 inscrip. Grip pb  some do 02LR00 (336)
Co-ordinates:	Matrix location:	Hinge
Levels	Preservation:	Bracket
Slide No. film 22	Neg No:	Fixing nails
		Shroud pins
		Fabric
		Other finds

Description
adult pb coffin ~~very precious sheet~~ coffin has inner frill.

Discussion
Under winding sheet, still wearing frilled cap. Woolly shroud pin sticking on frill of cap.



← AFTER →



Shape, dimensions and distinguishing characteristics

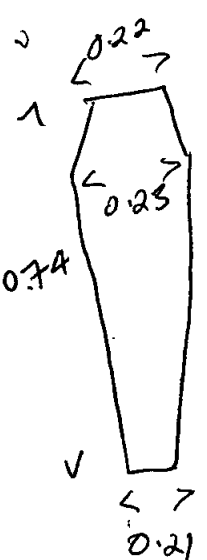

0.29 = deep

inscrip
Mrs Susan Joselin
Died 5th March
∴ 1816 ∴
Aged 35 yrs

plate  black polished
Mrs Susannah Joselyn
Died 5th March
1816
Aged 35 yrs.

BEFORE



lining/shroud cross folded on face area.

diff. undertakers = diff spelling?

coffin
inner frill - linen?

Recorder: _____ Date: _____ Initials: _____

db

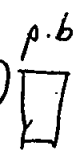
SITE <u>OLR00</u>		COFFIN RECORD SHEET	CONTEXT NO. <u>A 69</u>
Trench: <u>CRYPT</u>	Additional sheets:	Treatment: <u>skelly lifted</u> <u>& DNA taken</u>	
Site sub-div:	Grave fills		
Plan no: <u>7</u>	Grave cut:	Finds	
Section no:	Skeleton:	None Breastplate <u>inscript. plates (a) & (b)</u> 	
Co-ordinates:	Matrix location:	Hinge	
Levels	Preservation:	Bracket	
Slide No.	Neg No:	Fixing nails	
		Shroud pins	
		Fabric	
		Other finds	

Description adult p.b. coffin, w/ traces of bitumen/tar on inner surface
 (a) inner wood contain seam of board & sides  & remains have had a craniotomy. Infectious disease?

Discussion

Shape, dimensions and distinguishing characteristics

LID

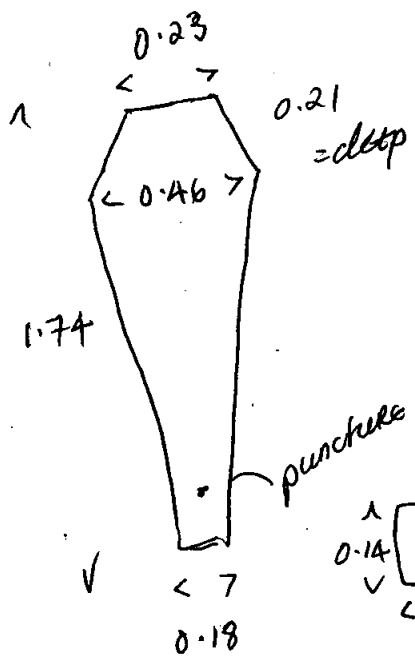

0.23
0.21 = deep.
0.46
1.74
0.18
0.14
puncture

HEAD

BASE

inscrip.
 " MR ~~Tribe~~ ^{Tribe}
 Thomas ~~Tribe~~
 Died 4th July
 1842
 In his 53rd yr
 " " " "

plate (b) p.b
 " MR
 Thomas Tribe
 Died 4th July
 1842
 In his 53rd year
 " " " "

plate (a) p.b
 " MR
 Thomas Tribe
 " 1842 " "

 0.14
 (a)
 0.21

spltds (21)
 w/out outer border.

Recorder:	Date:	Initials:
-----------	-------	-----------

SITE		CONTEXT RECORD		Context No. 470
OLR00		Additional Sheets:		Type STRUCTURE
Trench	Context Type: Deposit / Cut / Structure		Check Lists:	
Site sub-div CRYPT	Overlain by:		DEPOSIT:	
Structure No.	Abutted by:		1.compaction 2.colour 3.composition 4.inclusions 5.thickness 6.extent 7.comments 8.method & conditions	
Plan No. 7	Cut by:		CUT:	
	Filled by:		1.shape in plan 2.base/sides/top profile 3.dimension and depth 4.sketch 5.truncation 6.fill nos 7.other comments	
Section No.	Same as:		MASONRY:	
	Part of:		1.materials 2.size of bricks etc 3.finish of stones 4.coursing/bond 5.form 6.faces 7.bond 8.dimensions as found 9.other comments	
Co-Ordinates	Contains of: Contains Burials (471) → (474)			
Level	Overlies:			
Slide No. Film 22	Butts: (Vault 470 would have butted? against)			
Neg No.	Fill of: vault 251 to its south side.			
Matrix location	Relationships uncertain			
Description (See check lists):			STRATIGRAPHIC MATRIX	
<p>The east end of Bay 1 of the crypt, recorded by Jon Gill with latex block walls to a raised cement slab & steps to a round window/vent. When concrete broken out it was seen to be c. 0.15-0.20m thick & reinforced with what appear to be the gates from a railed vault type structure. Below the slab, 4 lead coffin burials were seen, covered with</p>				
			<p>this context is</p>	
<p>Interpretation/Discussion:</p> <p>Spoil to sitting on a brick floor c. 0.40m above the main floor level of Bay 1.</p> <p>Measured → 2.50 x 2.30m</p> <p>Probable vault → front dismantled & coffins covered with slab during later refurbishment works.</p>				
<p>Finds (tick): None <input type="checkbox"/> Pot <input type="checkbox"/> Bone <input type="checkbox"/> Flint <input type="checkbox"/> Stone <input type="checkbox"/> Burnt stone <input type="checkbox"/> Glass <input type="checkbox"/> Metal <input type="checkbox"/> CBM <input type="checkbox"/> Wood <input type="checkbox"/> Leather <input type="checkbox"/></p>				
<p>△Small Finds</p>			Recorder DS	
<p>◇Samples</p>			Date 3/10	
<p>△Building Materials</p>			Initials	

210

SITE <i>OLR00</i>	COFFIN RECORD SHEET	CONTEXT NO. <i>471</i>
Trench: <i>CRYPT</i>	Additional sheets:	Treatment: <i>INTACT NO SAMPLES TAKEN</i>
Site sub-div:	Grave fills	
Plan no: <i>7</i>	Grave cut:	Finds None <i>x1 diamond pb. - pinned to lid.</i>
Section no:	Skeleton:	Breastplate Grip <i>x3 - fe. spltds (down) (+)</i>
Co-ordinates:	Matrix location: <i>prob. vault 470 adj. to 472</i>	Hinge Bracket
Levels	Preservation: <i>7</i>	Fixing nails Shroud pins
Slide No.	Neg No:	Fabric Other finds

Description *sub. adult p.b. coffin*

Discussion

Shape, dimensions and distinguishing characteristics

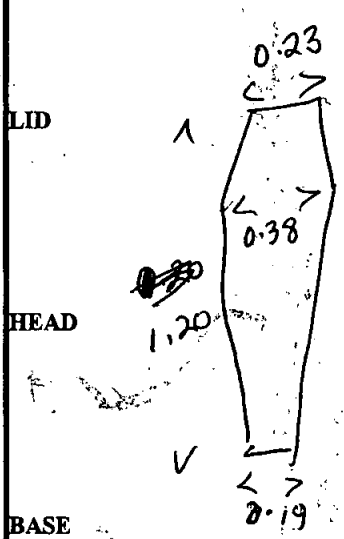

*"Miss
Eliza Cassell
Died 20th Feb^{ry} 1830
Aged 6 years"
plain*

prob. vault 470 has brick floor over spoil of about 0.30 depth.

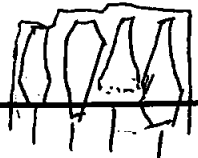

Recorder:	Date: <i>1/10</i>	Initials: <i>MR</i>
-----------	-------------------	---------------------

471 472 473 474

db

SITE	COFFIN RECORD SHEET	CONTEXT NO.
01100		472
Trench: crypt	Additional sheets:	Treatment: SKELETON LIFTED & DNA LIFTED
Site sub-div:	Grave fills	
Plan no: 7	Grave cut:	Finds None + 1 (rect) pb. (C) x 1 (top) brass (C) x 1 rect pb - (D) Grip x 5 spindles (C) - shield.
Section no:	Skeleton:	Breastplate Grip
Co-ordinates:	Matrix location: prob. Vault 470 adj. to 471 & 473	Hinge Bracket
Levels	Preservation: 2	Fixing nails Shroud pins
Slide No.	Neg No:	Fabric Other finds

Description
adult p.b. coffin, no note skeletal remains found in pelvis area - head engaged - (pointing towards adult feet)
adult covered in felted textile of v. long fibres - no weave, similar to human hair.

Discussion

Shape, dimensions and distinguishing characteristics

dep plate slightly tapered & barely legible

LID: 0.25 (top width), 0.46 (inner width), 1.70 (height), 0.27 = deep.
 HEAD: (C)
 BASE: 0.21 (width), 0.27 (height), (D)
 (E) Mrs Mary Ann Coswell DIED JUNE 1839 Aged 25 years
 (F) Mrs Mary Ann Coswell DIED JUNE 1839 Aged 25 years
 (G) Mrs Mary Ann Coswell DIED JUNE 1839 Aged 25 years
 (H) Mrs Mary Ann Coswell DIED JUNE 1839 Aged 25 years

Recorder:	Date: 4/10	Initials: MR
-----------	------------	--------------

db

SITE <i>0200</i>	COFFIN RECORD SHEET	CONTEXT NO. <i>473</i>
Trench: <i>CRYPT</i>	Additional sheets:	Treatment: <i>REMAINING BONE LIFTED - NO DNA - NO NAME.</i>
Site sub-div:	Grave fills	
Plan no: <i>7</i>	Grave cut:	Finds None
Section no:	Skeleton:	Breastplate <i>Grip x 1 frag @ shield</i>
Co-ordinates:	Matrix location: <i>prob. unit 470 adj. to 472 & 474</i>	Hinge Bracket
Levels	Preservation: <i>1</i>	Fixing nails Shroud pins
Slide No.	Neg No:	Fabric Other finds

Description *adult p.b. coffin, truncated from shoulders => head p.b. may be excessively oxidised rather than vandalised - remains missing from about pelvis up. coffin full of soil*

Discussion

Shape, dimensions and distinguishing characteristics

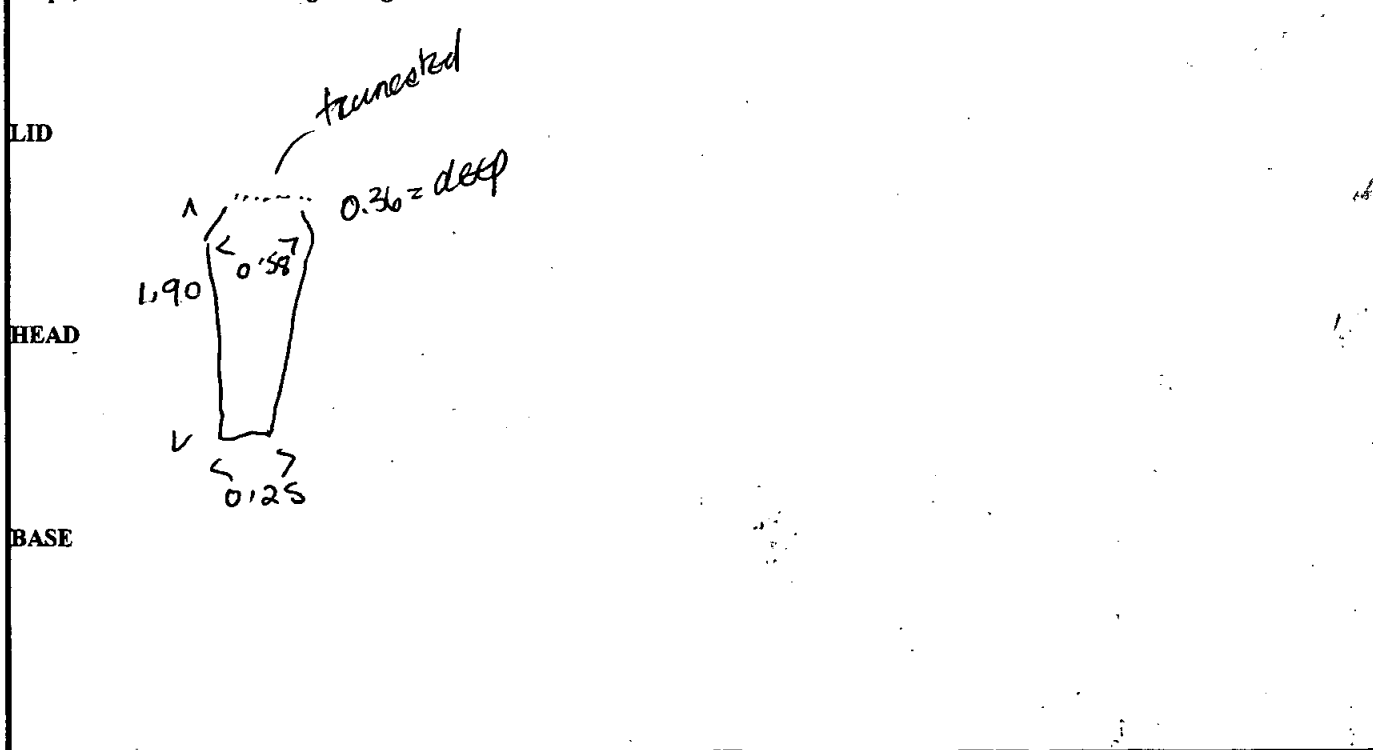

Recorder:	Date: <i>4/10</i>	Initials: <i>MR</i>
-----------	----------------------	------------------------

db

SITE OLR06	COFFIN RECORD SHEET	CONTEXT NO. 47A
Trench: CRYP1	Additional sheets:	Treatment: SKELETON LIFTED - NO DNA TAKEN.
Site sub-div:	Grave fills	
Plan no: 7	Grave cut:	Finds None
Section no:	Skeleton:	Breastplate Grip
Co-ordinates:	Matrix location: prob. vault 470 adj. to 437	Hinge Bracket
Levels	Preservation:	Fixing nails Shroud pins
Slide No.	Neg No:	Fabric Other finds

Description adult p.b. coffin, channelised skull in back fill - lid (pb) missing & interior filled with soil & skull missing - No Dep plate.

Discussion

Shape, dimensions and distinguishing characteristics

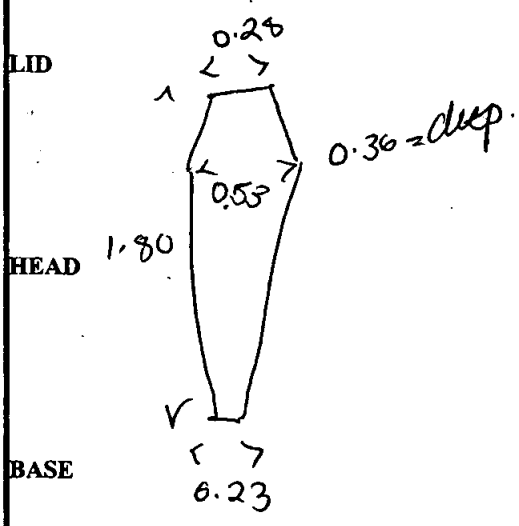

Recorder:	Date: 2/10	Initials: MK
-----------	------------	--------------

db

SITE	COFFIN RECORD SHEET	CONTEXT NO.
02100		A-75
Trench: crypt	Additional sheets:	Treatment: TEETH TAKEN. NO BONES - DNA (NO B)
Site sub-div:	Grave fills	
Plan no: 7	Grave cut:	Finds None
Section no:	Skeleton:	Breastplate x1 pb <input type="checkbox"/> soldered. Grip x1 spltds (A) w/ol chcr.
Co-ordinates:	Matrix location: in bay 3	Hinge
Levels	Preservation: 1	Bracket
Slide No.	Neg No:	Fixing nails Shroud pins
		Fabric Other finds

Description adult p.b. coffin; poss buried in w/ollen shroud - this has led to adipocere preservation so teeth taken, but no bones for DNA:

Discussion

Shape, dimensions and distinguishing characteristics

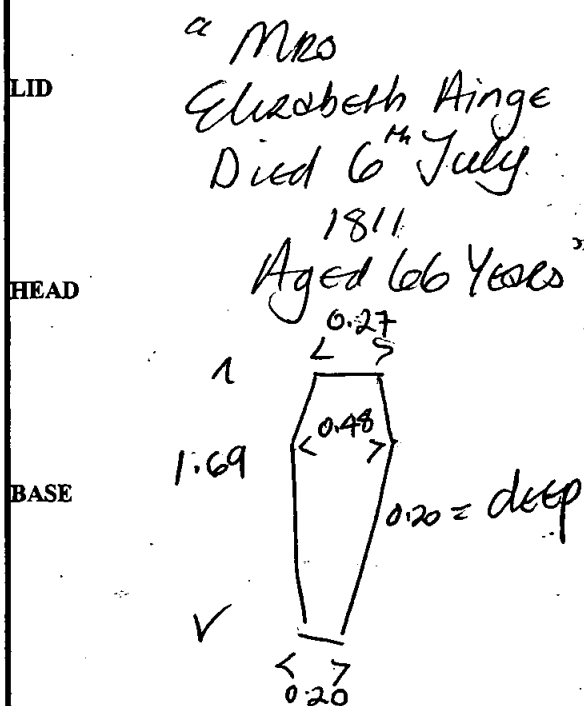

Recorder:	Date: 3/10	Initials: MR.
-----------	------------	---------------

db

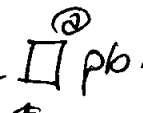
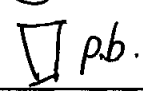
SITE	COFFIN RECORD SHEET	CONTEXT NO.
02R00		A76
Trench: CRYPT	Additional sheets: YES x1	Treatment: INTACT.
Site sub-div:	Grave fills	
Plan no: 7	Grave cut:	Finds
		None
Section no:	Skeleton:	Breastplate x2 -  pb. set
		Grip  pb.
Co-ordinates:	Matrix location: in Bay 3	Hinge
		Bracket
Levels	Preservation: 4	Fixing nails
		Shroud pins
Slide No.	Neg No:	Fabric
		Other finds

Description: adult p.b. coffin

Discussion:

Shape, dimensions and distinguishing characteristics

LID

① "The Rev. Will^m Valentine Freeson Died 5th April 1822 Aged 69 Years" nailed on lid

② "The Rev. Will^m Valentine Freeson Died 5th April 1822 Aged 69 Years" spt fdb -

(similar to  bottom.)

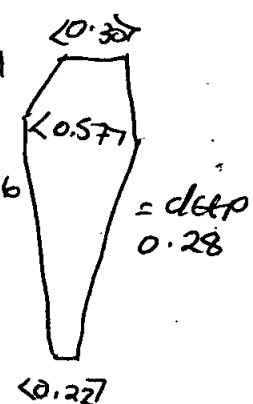
③ 

Recorder: Date: 3/10 Initials: MK

db

SITE	COFFIN RECORD SHEET	CONTEXT NO.
0LR00		A77
Trench: CRYPT	Additional sheets:	Treatment: SKULLY LIFTED DNA TAKEN
Site sub-div:	Grave fills	
Plan no: 7	Grave cut:	Finds None Breastplate - <input type="checkbox"/> p.b. Grip x 1 spfbs ① - conc.
Section no:	Skeleton:	
Co-ordinates:	Matrix location: in Bay 3	Hinge Bracket
Levels	Preservation: 2 1	Fixing nails Shroud pins
Slide No.	Neg No:	Fabric Other finds

Description

Discussion

Shape, dimensions and distinguishing characteristics

LID

HEAD

BASE

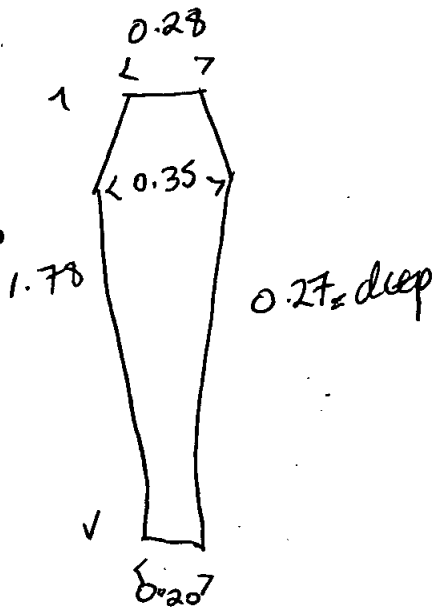

"Mrs
Ann Turner
Died 15th May
1799
In her 68th year"
plain rect w/ border line.
nailed on.

Recorder:

Date:

3/10

Initials:

MR

db

SITE OLR00	COFFIN RECORD SHEET	CONTEXT NO. 478
Trench: CRYPT	Additional sheets:	Treatment: SKULLY LIFTED DNA TAKEN
Site sub-div:	Grave fills	
Plan no: 7	Grave cut:	Finds None Inscription \square
Section no:	Skeleton:	Breastplate Grip x 1 - b. conc. prob. sp. Hds ①
Co-ordinates:	Matrix location: under 356 in bay 3	Hinge Bracket + frag of fe. grip plate - dec w/ cadaverine
Levels	Preservation:	Fixing nails Shroud pins
Slide No.	Neg No:	Fabric Other finds

Description

Discussion

Shape, dimensions and distinguishing characteristics

LID

HEAD

BASE

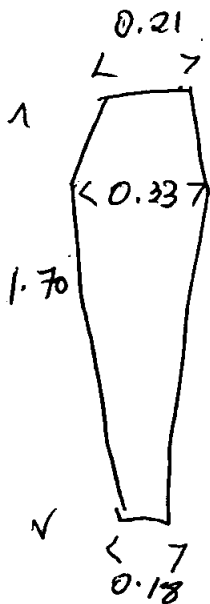

0.23 = depth



punched dot border
"Memo
Mary Tuford
Died 9th Nov 1827
Aged 65 yrs"

Recorder:

Date:

Initials:

db

SITE	COFFIN RECORD SHEET	CONTEXT NO.
OLR00		479
Trench: CRYPT	Additional sheets:	Treatment: SKELUM LIFTED DNA TAKEN
Site sub-div:	Grave fills	
Plan no: 7	Grave cut:	Finds
		None
Section no:	Skeleton:	Breastplate - pb  plain nailed on lid Grip - pb 
Co-ordinates:	Matrix location: under 355 & 356 in Bay 3	Hinge
Levels	Preservation: 2	Bracket
Slide No.	Neg No:	Fixing nails
		Shroud pins
		Fabric
		Other finds

Description: adult p.b coffin - inner wood lid w/ dbl row - under p.b. lid

Discussion: (fe. studs w/ black enamel) sphtls (3)

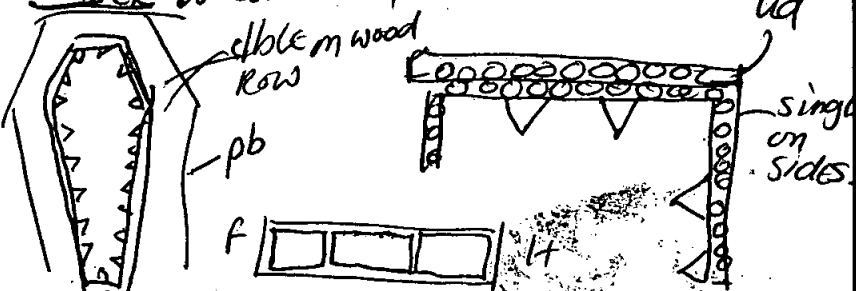

Shape, dimensions and distinguishing characteristics

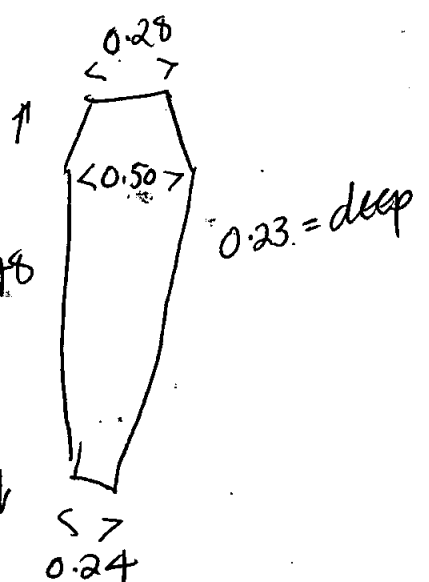

(a) "Mrs Mary Elizth Hodcker
Died 21st July
1831
Aged 72 Yrs"

(b) "Mrs Mary Elizth Hodcker
Died 21st July
1831"

thick layer of bron w/ white mould under wooden lid which is coating skeletal remains, preservation reasonable considering presence of bron/mould. 20.167

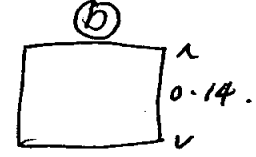

Recorder:	Date: 3/10/20	Initials: MK.
-----------	---------------	---------------

ab

SITE	COFFIN RECORD SHEET	CONTEXT NO.
OLR00		480
Trench: CRYPT	Additional sheets:	Treatment: INTACT
Site sub-div:	Grave fills	
Plan no: 7	Grave cut:	Finds
Section no:	Skeleton:	None dep p.b.  Breastplate inscript. - on lid (b) Grip x1
Co-ordinates:	Matrix location: m Boy A	Hinge
Levels	Preservation: 4	Bracket
Slide No.	Neg No:	Fixing nails
		Shroud pins
		Fabric
		Other finds

Description infant p.b. coffin

infant grip (conc.) x 1 = terminal to terminal - 0.09
drop - 0.04

Discussion

Shape, dimensions and distinguishing characteristics

LID (a) "Master Douglas Bailey 1939"

(b) "Master Douglas Bailey Died 13th Month 1939 Aged --- Months"

HEAD

BASE

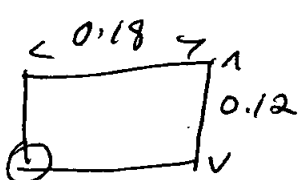
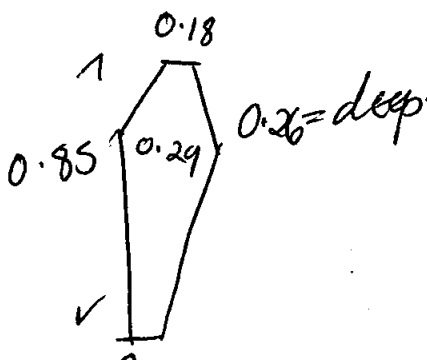
Recorder: Date: 4/10 Initials: MR.

db

SITE	COFFIN RECORD SHEET	CONTEXT NO.
OLR00		481
Trench: CRYPT	Additional sheets: YES x 1	Treatment: INTACT
Site sub-div:	Grave fills	
Plan no: 7	Grave cut:	Finds
Section no:	Skeleton:	None Breastplate x 1 p.b. + 1 p.b. + inscription Grip x 2 (frag)
Co-ordinates:	Matrix location: in Bay A	Hinge
Levels	Preservation: A	Bracket up studs x 2 pieces Fixing nails Shroud pins
Slide No.	Neg No:	Fabric
		Other finds dec. tin pewter plate w/ husk flower enamel.

Description in font p.b. coffin assoc. w/ mini version of adult type dep. plate w/ base on rev.

Discussion

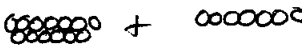
 = total 20 studs

Shape, dimensions and distinguishing characteristics

LID

(a) "Master Albert Bailey 1838"

(b) "Master Albert Bailey Died 2nd May ∴ 1838 ∴ Aged 2 years."

HEAD

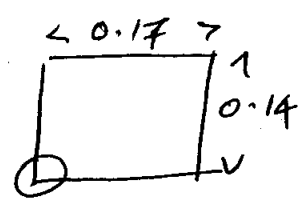

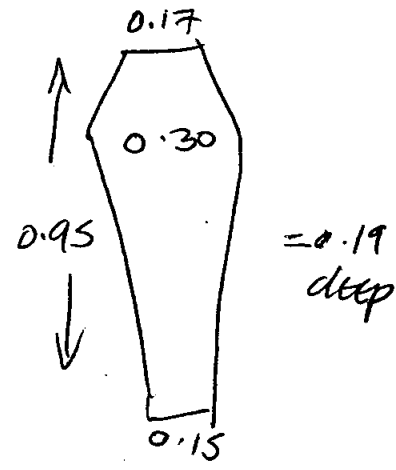

BASE

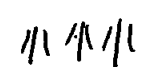

Recorder: Date: 4/10 Initials: MK

db

SITE	COFFIN RECORD SHEET	CONTEXT NO.
02200		482
Trench: CRYPT	Additional sheets:	Treatment: SKULLY LIFTED - HEAD MISSING - NO DNA - NO NAME.
Site sub-div:	Grave fills	
Plan no: 7	Grave cut:	Finds ✓ 1x shell button None
Section no:	Skeleton:	Breastplate Grip
Co-ordinates:	Matrix location: in Bay A	Hinge Bracket
Levels	Preservation: 1 (BODY) 3	Fixing nails Shroud pins
Slide No.	Neg No:	Fabric Other finds

Description adult p.b. coffin. end (H) opened & undisturbed. orig in centre (E-W) of bay, but dug up, robbed & discarded on top of spoil. No textiles on inner wooden case.

Discussion

Shape, dimensions and distinguishing characteristics

LID

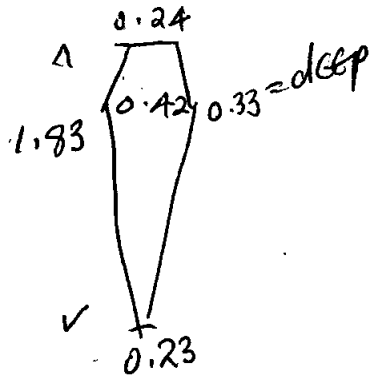

HEAD

BASE

Recorder:	Date:	Initials:
-----------	-------	-----------

SITE		CONTEXT RECORD		Context No. 483
OLROO		Additional Sheets: YES 1		Type STRUCTURE
Trench	Context Type: Deposit / Cut / <u>Structure</u>			Check Lists:
Site sub-div SC	Overlain by:			DEPOSIT: 1.compaction 2.colour 3.composition 4.inclusions 5.thickness 6.extent 7.comments 8.method & conditions
Structure No.	Abutted by:			
Plan No. 6	Cut by:			CUT: 1.shape in plan 2.base/sides/top profile 3.dimension and depth 4.sketch 5.truncation 6.fill nos 7.other comments
Section No. 12	Filled by:			
Co-Ordinates	Same as:			MASONRY: 1.materials 2.size of bricks etc 3.finish of stones 4.coursing/bond 5.form 6.faces 7.bond 8.dimensions as found 9.other comments
Level	Part of:			
Slide No.	Consists of: Contains burials 484 → 491.			
Neg No.	Overlies:			
Matrix location	Butts:			
	Cuts:			
	Fill of:			
	Relationships uncertain			
Description (See check lists): E-W orientated brick vault. Arch - N-S.				STRATIGRAPHIC MATRIX
Internal dimensions:- 2.10 x 1.30m to 2.5m				
from floor to top of arch.				
Bricks - 0.22 x 0.10 x 0.06m mortar - hard				
cement. Coursing - alternate header + stretcher courses on walls + arch.				
Floor - stone slabs - mortared. Entrance - 4 steps with brick side walls + 2 piece stone slab (sloping) cover.				
Interpretation/Discussion: VAULT				
Appears undisturbed/clean although coffins have collapsed somewhat → mixture of wood to lead lined coffins.				
Finds (tick): None <input type="checkbox"/> Pot <input type="checkbox"/> Bone <input type="checkbox"/> Flint <input type="checkbox"/> Stone <input type="checkbox"/> Burnt stone <input type="checkbox"/> Glass <input type="checkbox"/> Metal <input type="checkbox"/> CBM <input type="checkbox"/> Wood <input type="checkbox"/> Leather <input type="checkbox"/>				
ΔSmall Finds			Recorder DS	
◇Samples			Date 5/10	
△Building Materials			Initials	

SITE OLR00	CONTEXT RECORD ADDITIONAL SHEET	Context No. 483
---------------	---------------------------------	--------------------

Additional feature :- walls at entrance are beveled (not seen in many of the other vaults on this site ie. -

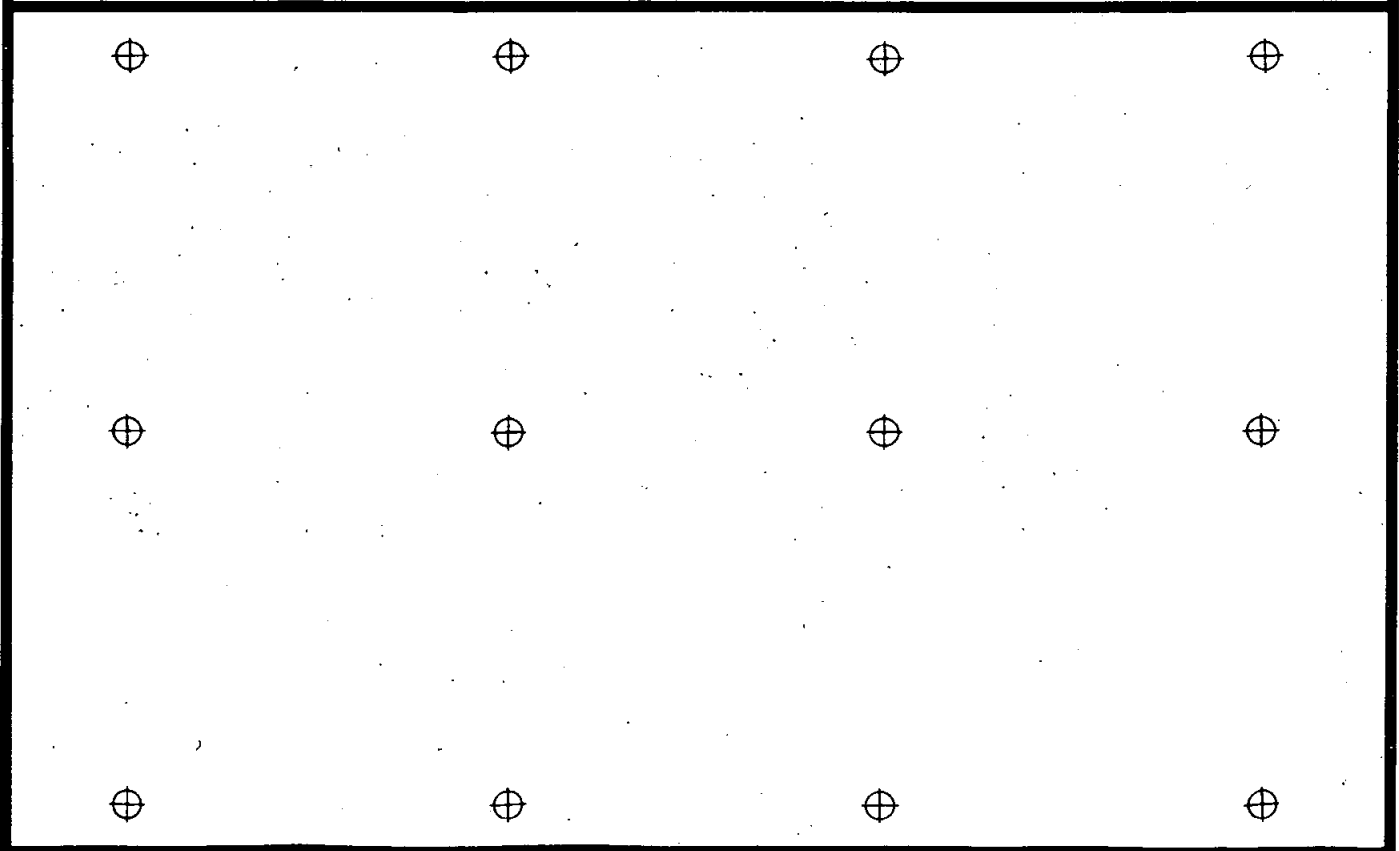
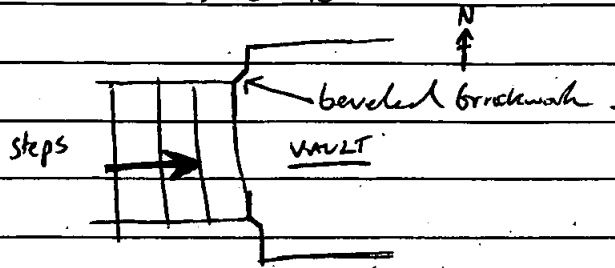

Vault Sketch.

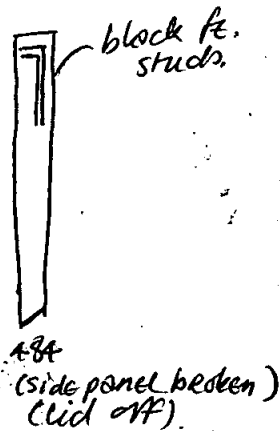
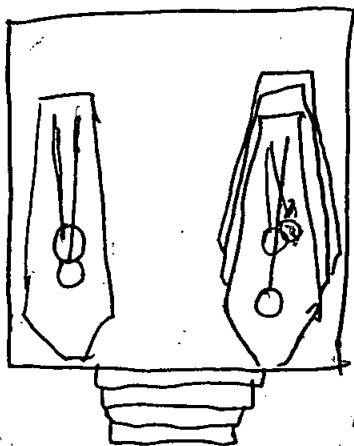
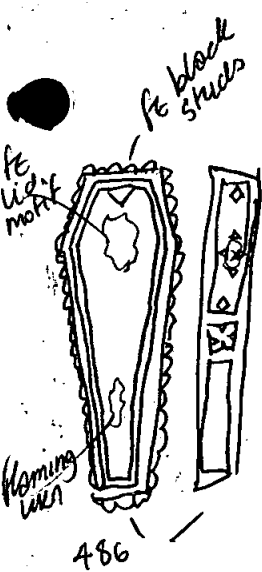
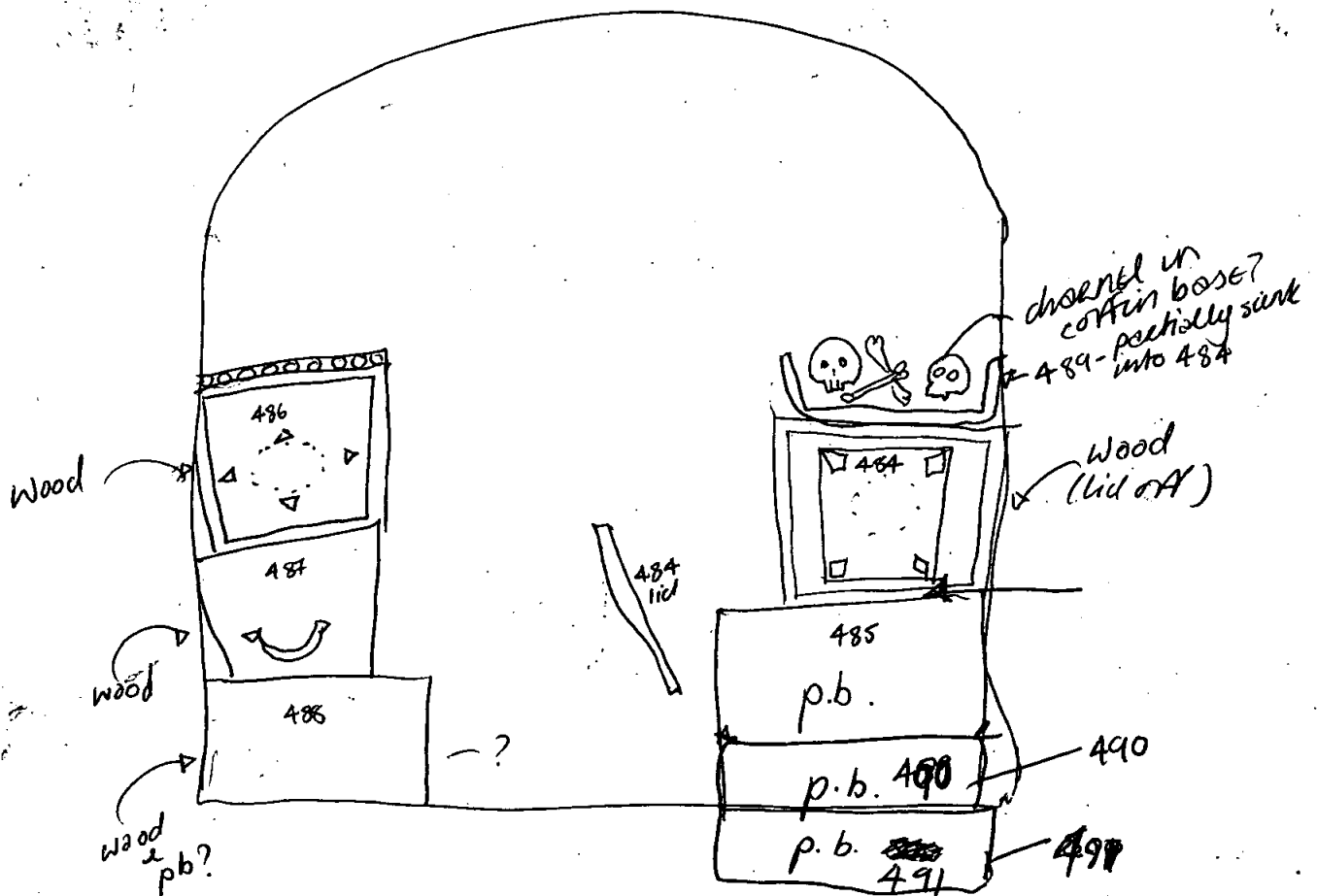

db

SITE 04200	COFFIN RECORD SHEET	CONTEXT NO. 484
Trench: SC	Additional sheets:	Treatment: SKELLY LIFTED - FRAGS.
Site sub-div:	Grave fills	
Plan no: 6	Grave cut:	Finds None
Section no:	Skeleton:	Breastplate Grip
Co-ordinates:	Matrix location: in vault 483 under 489 over 485.	Hinge Bracket
Levels	Preservation:	Fixing nails Shroud pins ✓ x1
Slide No.	Neg No:	Fabric Other finds :

Description wooden coffin w/ fe up stud patterns

Discussion  fe lid demotif - samped fe, sect. sheps completely fragmented. coffin completely collapsed lid onto ~~base~~ side onto base - skelly practically disintegrated. lining textile on base board

Shape, dimensions and distinguishing characteristics

up stud design.

LID

HEAD

BASE

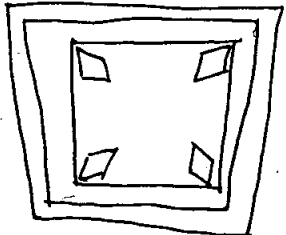

H

Recorder:	Date:	Initials:
-----------	-------	-----------

db

SITE		COFFIN RECORD SHEET		CONTEXT NO.	
0200				485	
Trench:	S.C.	Additional sheets:	Treatment:		
Site sub-div:		Grave fills	SKELLY UPTED		
Plan no:	6	Grave cut:	Finds		
Section no:		Skeleton:	None		
Co-ordinates:		Matrix location: in vault 483. under 484. over 490	Breastplate		
Levels		Preservation:	Grip		
Slide No.		Neg No:	Hinge		
Description		p.b. coffin - wood outer lid w/ oxidized dep. plate - illegible - over degraded p.b. lid over wooden inner lid, body also in poor condition. No furniture surviving. p.b lid edge has fe. wire reinforcement - poor quality?			
Discussion					
Shape, dimensions and distinguishing characteristics					
LID					
HEAD					
BASE					
Recorder:	Date:	9/10	Initials:	MR.	

db

SITE	COFFIN RECORD SHEET	CONTEXT NO.
01200		486
Trench: S.C.	Additional sheets: YES x 5.	Treatment: SKELETON LIFTED - NO NAME - NO DNA.
Site sub-div:	Grave fills	
Plan no: 6	Grave cut:	Finds - 3 x plates - lid motifs None (collar & hemming iron)
Section no:	Skeleton:	Breastplate Grip x 2 o plate frags
Co-ordinates:	Matrix location: in vault 483. over 487	Hinge Bracket up studs
Levels	Preservation:	Fixing nails - large fe. (black) Shroud pins
Slide No.	Neg No:	Fabric ✓ Boize. Other finds
<p>Description wooden coffin w/ stamped fe. lid furniture, but no legible Dep. plate. Body ^{wood shroued} poor poor cond., no measurements possible as coffin collapsed when touched.</p> <p>Discussion</p>		
<p>Shape, dimensions and distinguishing characteristics</p> <p>LID</p> <p>HEAD</p> <p>BASE</p>		
Recorder:	Date: 5/10	Initials: MR

Coffin Recording Sheet

Site Code

Context

Outer Coffin

Sample Ret.

OLR00

486

Recording Date 5/10

Associated Numbers IN VAULT 483

Condition 2

Dep. Plate

Legible NO

Inscription

“Died”

Fabric lead ormolou brass tin plated pewter gilt tin
 iron silvered tin enamelled other Sample Ret.

Shape of dep. plate

square rectangle shield tapered lozenge
 cartouche oval other

Upholstery

colour shoddy velvet other Sample Ret.

Construction

butt joint mitred pitched other

Grip plate Fabric = ormolou brass tin plated pewter gilt tin
 iron silvered tin enamelled other Sample Ret.

Grip 2 sptlds 20's Fabric = ormolou brass iron Sample Ret.

Design

swag of rose horseshoe cherub's head plain

other

Grip bolts Corner bolts Type = gilt brass brass iron

other Sample Ret.

Lid motifs other x 3/4 see sheets. Sample Ret.

Escutcheons other Sample Ret.

Upholstery nails brass gilt brass silvered brass iron enamelled

other Sample Ret.

Fixings panel nails screws hinges lace Sample Ret.

Timber type Sample Ret.

Interpretation / Comments

.....

② lid motif fe.



* 0.13

0.27

0.12

0.05

00200

486
cond

Lid Motif (b)



Decorative plate frogs

(c)

(d)



|||



|||

62100

486

up. stud. design.

dbl row on lid surface &
single row on lid edge.

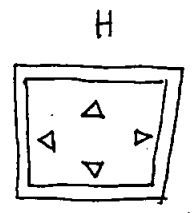
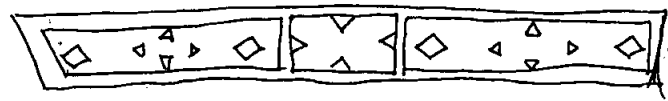
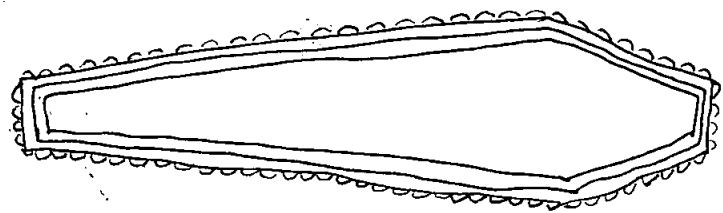

db

SITE	COFFIN RECORD SHEET	CONTEXT NO.
OLR00		487
Trench: S.C.	Additional sheets:	Treatment: SKELETON LIFTED
Site sub-div:	Grave fills	
Plan no: 6	Grave cut:	Finds
Section no:	Skeleton:	None Dep plate - fe. illegible (a) Breastplate Grip + plate stamped fe. (b) (c) + foot? plate (d)
Co-ordinates:	Matrix location: in vault 483 under 486, over 488	Hinge
Levels	Preservation: 1	Bracket
Slide No.	Neg No:	Fixing nails
		Shroud pins
		Fabric
		Other finds

Description wooden coffin, badly compressed, body inside been used.
No measurements poss. Remains in v. poor condition.

Discussion

Shape, dimensions and distinguishing characteristics

LID

HEAD

BASE

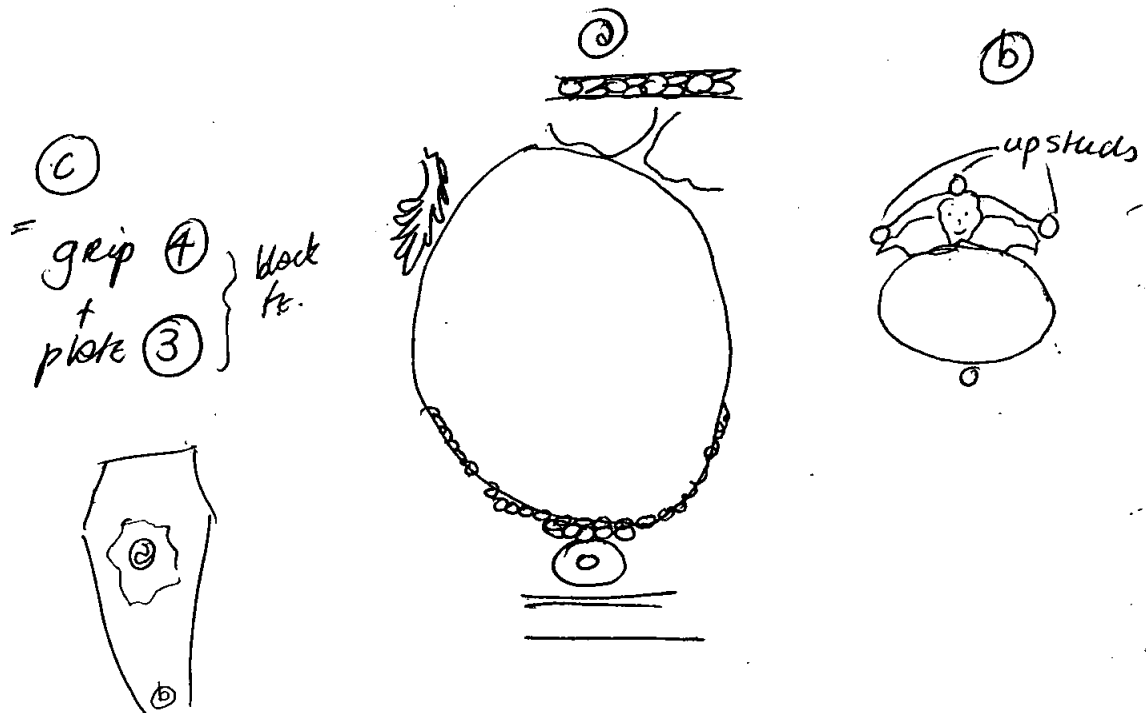

Recorder:	Date: 5/10	Initials: MR
-----------	------------	--------------

0200

487

cont.

plate (b)
escutcheon? small
lid motif?

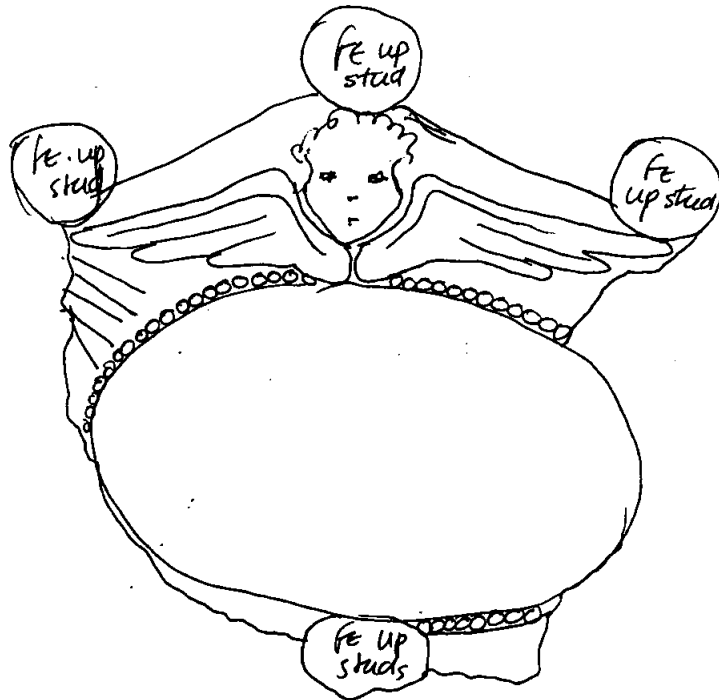

(1)

db

SITE	COFFIN RECORD SHEET	CONTEXT NO.
0LR00		488
Trench: S.C.	Additional sheets: YES x 1	Treatment: SKELLY LIFTED & DNA TAKEN
Site sub-div:	Grave fills	
Plan no: 6	Grave cut:	Finds dep plate inscript. (3) None dep plate <input type="checkbox"/> boxely p.b. (6) Legible <input type="checkbox"/> black tin (3) Grip x 2 + plates - fe grip (4) d/b/d
Section no:	Skeleton:	Hinge Bracket Fixing nails Shroud pins
Co-ordinates:	Matrix location: in vault 483, under 487.	Fabric
Levels	Preservation:	Other finds <input type="checkbox"/> Ag. ring
Slide No.	Neg No:	

Description p. b. coffin (3)



Discussion (3) "Mes Elizth Rider Died 31st Jan 1819 Aged 70 Y" (3)
p. b. nailed on lid

Shape, dimensions and distinguishing characteristics (3)

LID (3) fe lid motif. (3)

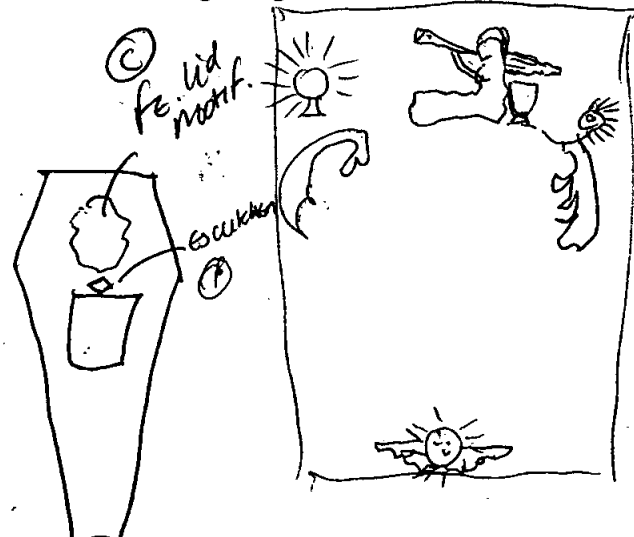

HEAD (3)

BASE (3)

H F

Block lg fe studs

"Mes Rider Eliz. ~~pat~~? Died 31 ~~Jan~~ Jan 1819? Aged 70. Yrs." (3)
upholstered in beige.

Recorder: Date: 5/10 Initials: MR

Site Code

Context

Outer Coffin

Sample Ret.

OXR00

488

Recording Date 5/10

Associated Numbers IN VAULT 483

Condition 2

Dep. Plate

Legible (ish)

Inscription *see previous sheet*

sptfds ⑨ w/ diff. outer border.

Fabric lead ormolou brass tin plated pewter gilt tin
 iron silvered tin enamelled other Sample Ret.

Shape of dep. plate

square rectangle shield tapered lozenge
 cartouche oval other

Upholstery

colour shoddy velvet other Sample Ret.

Construction

butt joint mitred pitched other

Grip plate

Fabric = ormolou brass tin plated pewter *Both* gilt tin

iron silvered tin enamelled *Black both* other *sptfds ③* Sample Ret.

Grip

Fabric = ormolou brass iron Sample Ret.

Design

swag of rose horseshoe cherub's head plain

other

Grip bolts

Corner bolts Type = gilt brass brass iron

other Sample Ret.

Lid motifs

other *1x fe sptfds ⑥* Sample Ret.

Escutcheons

other *x 2: 1x sptfds ① ② side - (silvered tin)* Sample Ret.

Upholstery nails

brass gilt brass silvered brass iron enamelled

other Sample Ret.

Fixings

panel nails screws hinges lace Sample Ret.

Timber type

Sample Ret.

Interpretation / Comments

.....

dlb.

SITE 0LR00	COFFIN RECORD SHEET	CONTEXT NO. 489
Trench: SC.	Additional sheets:	Treatment: BONES LIFTED
Site sub-div:	Grave fills	
Plan no: 6	Grave cut:	Finds None
Section no:	Skeleton:	Breastplate Grip
Co-ordinates:	Matrix location: in vault 483 over 484	Hinge Bracket
Levels	Preservation: 1	Fixing nails Shroud pins
Slide No.	Neg No:	Fabric Other finds
Description <i>only base board surviving w/ channel/mixed inhumations piled on top - all bagged as one, to be planned in later when we know how many there are.</i>		
Discussion		
Shape, dimensions and distinguishing characteristics		
LID		
HEAD		
BASE		
Recorder:	Date: 3/10	Initials: MR

db

SITE 01200	COFFIN RECORD SHEET	CONTEXT NO. A90
Trench:	Additional sheets:	Treatment: SKELETON LIFTED.
Site sub-div:	Grave fills	
Plan no:	Grave cut:	Finds None
Section no:	Skeleton:	Breastplate Grip
Co-ordinates:	Matrix location: in vault 483 under 485, over 482 ⁴⁹¹	Hinge Bracket
Levels	Preservation:	Fixing nails Shroud pins
Slide No.	Neg No:	Fabric Other finds
<p>Description: p.b. coffin squashed by 485. - no name, poor condition - e.g. vertebrae fused onto underneath of inner wooden case, - poor quality p.b.?</p> <p>Discussion:</p>		
<p>Shape, dimensions and distinguishing characteristics</p> <p>LID</p> <p>HEAD</p> <p>BASE</p>		
Recorder:	Date: 3/10	Initials: MK

db

SITE	COFFIN RECORD SHEET	CONTEXT NO.
Trench: <i>S.C.</i>	Additional sheets:	Treatment: <i>TEETH TAKEN FOR DNA - NO BONES</i>
Site sub-div:	Grave fills	
Plan no: <i>6</i>	Grave cut:	Finds None <i>x 1 pb (illegible)</i> <i>x 1 pb solder</i>
Section no:	Skeleton:	Breastplate Grip
Co-ordinates:	Matrix location: <i>in vault 483 under 490</i>	Hinge Bracket
Levels	Preservation: <i>3</i>	Fixing nails Shroud pins
Slide No.	Neg No:	Fabric Other finds

Description
p.b. sub adult coffin, v. good cond. ⁶ Miss Burnill ⁷ ~~Berkett?~~ ¹⁷ ~~1774?~~ Aged 9 Years
fully shrouded & bonnet & frilled ^{liner-} Elizth Burnill? Died 18th July 1774
(night-dress type) shroud w/ frilled cuffs - all frills/edges have pin-hole lace details, ~~on~~ head on "Aged 9 Years" Aged 9 Years
small pillow - pressed whole but shroud holding remains together - disintegrated on touching.

Shape, dimensions and distinguishing characteristics

sitting on stone runner & stone slab floor

LID

HEAD

BASE

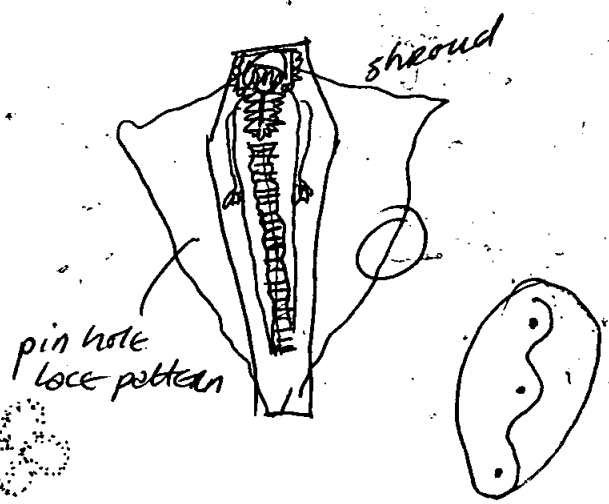
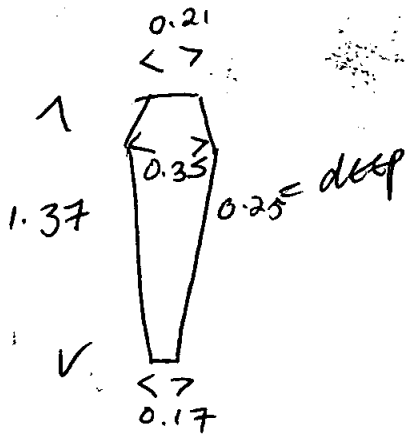

Recorder:	Date: <i>5/10</i>	Initials: <i>MR.</i>
-----------	-------------------	----------------------

db

SITE	OLR00	COFFIN RECORD SHEET	CONTEXT NO. 492
Trench:	CRYPT	Additional sheets:	Treatment: SKELETON LIFTED DNA TAKEN
Site sub-div:		Grave fills	
Plan no:	7	Grave cut:	Finds None
Section no:		Skeleton:	Breastplate ✓ x 1 beads Grip x 2 Fe } (3) } db ch. x 2 Fe plates } (4)
Co-ordinates:		Matrix location: m Bay 3 in vault 23	Hinge
Levels		Preservation:	Bracket
Slide No.		Neg No:	Fixing nails Shroud pins
			Fabric Other finds

Description
p/b coffin - vandalised, lid opened @ head end
no skull, therefore no teeth.

Discussion

Shape, dimensions and distinguishing characteristics

LID

HEAD

BASE

John ~~Capion~~ Capion?
Esq. "baredly"
[the rest is illegible]
? Died 18~~33~~ May
1833
Aged 78 years"

0.35
0.65
1.78
0.24
0.40 = deep

Recorder: Date: 5/10 Initials: MR

26

SITE 02100	COFFIN RECORD SHEET	CONTEXT NO. A93
Trench: CRYPT	Additional sheets:	Treatment: INTACT
Site sub-div:	Grave fills	
Plan no: 7	Grave cut:	Finds None inscription
Section no:	Skeleton:	Breastplate Grip
Co-ordinates:	Matrix location: in vault 251 a u	Hinge Bracket
Levels	Preservation:	Fixing nails Shroud pins
Slide No.	Neg No:	Fabric Other finds

Description: intact p.b. infant coffin.

Discussion

Shape, dimensions and distinguishing characteristics

LID

HEAD

BASE

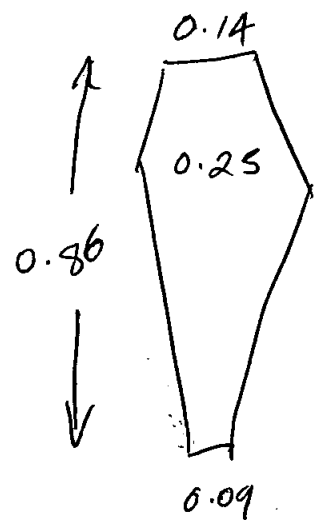

0.14 = deep

" Miss
Cath^{re} Forbes
Died 4th May
1777
Aged 9 Months "

Recorder:	Date: 5/10	Initials: MR
-----------	---------------	-----------------

db

SITE 02R00	COFFIN RECORD SHEET	CONTEXT NO. 49A
Trench: CRMDT	Additional sheets: YES x 2	Treatment: SKEWY LIFTED ~ DNA TAKEN
Site sub-div:	Grave fills	
Plan no: 7	Grave cut:	Finds None x 1 p.b. (2) on lid
Section no:	Skeleton:	Breastplate Grip
Co-ordinates:	Matrix location: in vault 231 W	Hinge Bracket
Levels	Preservation:	Fixing nails Shroud pins
Slide No.	Neg No:	Fabric Other finds

Description

Discussion

Shape, dimensions and distinguishing characteristics

~~same as 49B~~

(2)

" Wllm Wood Gent
 1756
 AE tot 46"
 ob' y's May 8

0.27
 1.96
 0.53
 0.23
 = 0.39 deep

LID

HEAD

BASE

Recorder:	Date: 5/10	Initials: MR
-----------	---------------	-----------------

02000

NEW number

p.b. plate.

(0.42 x 0.33)

494

" Will^m Wood Gent

Ob^t May ye 8th

1756

Act 46"

db

SITE	COFFIN RECORD SHEET	CONTEXT NO.
OR600		415
Trench: CRYPT	Additional sheets:	Treatment: SKELETON LIFTED DNA TAKEN
Site sub-div:	Grave fills:	
Plan no: 7	Grave cut:	Finds None x 2 pb. (a) (b)
Section no:	Skeleton:	Breastplate Grip → spltds (swagross) (c) (d)
Co-ordinates:	Matrix location: in vault 251 u/	Hinge Bracket
Levels:	Preservation:	Fixing nails Shroud pins
Slide No.:	Neg No.:	Fabric Other finds

Description: adult p.b. coffin

Discussion:

Shape, dimensions and distinguishing characteristics

① sent to 488
"Mr
William Wood
Died 28th
1777
Aged 24"

② plain
"William Wood
Died 28th Jan^e
1777
Aged 24"

deep = 0.34

③ with outer board

Recorder:	Date:	Initials:
-----------	-------	-----------

SITE		CONTEXT RECORD		Context No. 496
0200		Additional Sheets:		Type VAULT
Trench	Context Type: Deposit / Cut / Structure			Check Lists:
Site sub-div S.C.	Overlain by:			DEPOSIT: 1.compaction 2.colour 3.composition 4.inclusions 5.thickness 6.extent 7.comments 8.method & conditions
Structure No. 406	Abutted by:			
Plan No. 6	Cut by:			CUT: 1.shape in plan 2.base/sides/top profile 3.dimension and depth 4.sketch 5.truncation 6.fill nos 7.other comments
Section No.	Filled by:			
Co-Ordinates	CONTAINS: 497 535 599 600			MASONRY: 1.materials 2.size of bricks etc 3.finish of stones 4.coursing/bond 5.form 6.faces 7.bond 8.dimensions as found 9.other comments
Level	Butts:			
Slide No.	Cuts:			
Neg No.	Fill of:			
Matrix location	Relationships uncertain			

Description (See check lists):
 RED BRICKS 225 x 65 x 100 mm
 V. GRM CONCRETE RUN MORTAR.
 INTERNAL MEASUREMENTS:-
 2.05m x 1.3m x 1.15m HIGH.
 (EAST-WEST) (N-S)

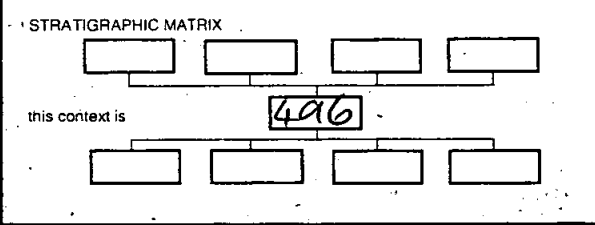

16 COURSES HIGH (INCLUDING FOOTINGS) - ALTERNATE HEADER + STRUTCHER COURSES.
 ENTRANCE ON WEST SIDE THRU SLAB BLOCKED OPENING

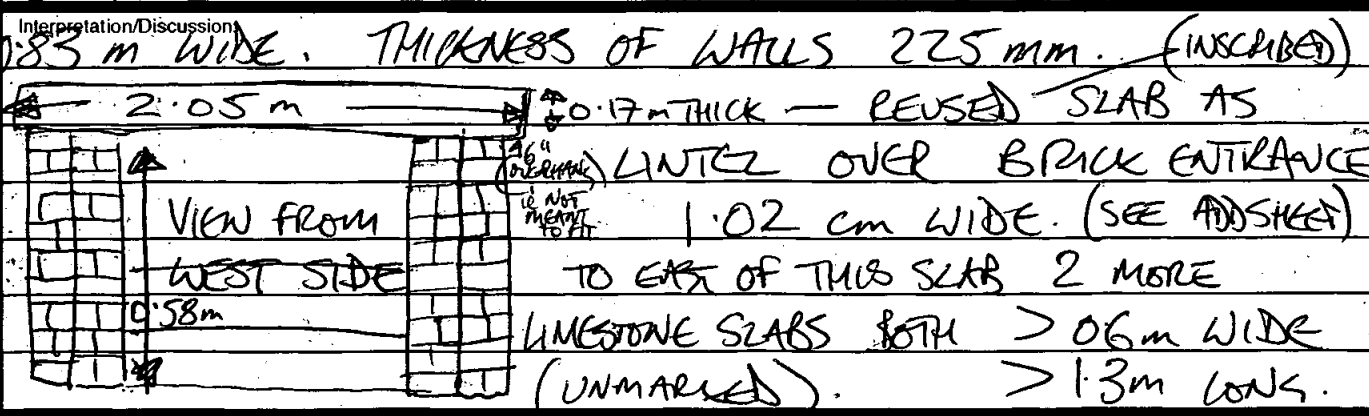

Finds (tick): None Pot Bone Flint Stone Burnt stone Glass Metal
 CBM Wood Leather

△ Small Finds	Recorder <i>[Signature]</i>
◇ Samples	Date 10.10.00
⊖ Building Materials	Initials

SITE OL100.	CONTEXT RECORD ADDITIONAL SHEET	Context No. 496 CONT.
----------------	---------------------------------	--------------------------

The Vault 496 Appears to have been constructed for the burial of Coffins 497 + 535 + By chance (or design?) overlay the grave cut containing coffins 599 + 600.

That this may have been deliberate is attested to by the fact that both 497 + 600 appear to have the same surname 'Lonie' (certainly on 600, though possibly 'Jones' or 'Love' on 497) - a bit unclear. - DNA testing could shed light on the matter.

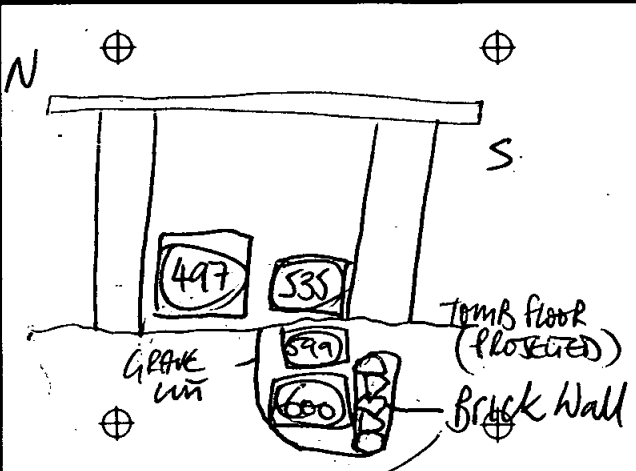

North Side of which Appears Damaged by Spade - possibly South Side of Grave but for 599 + 600

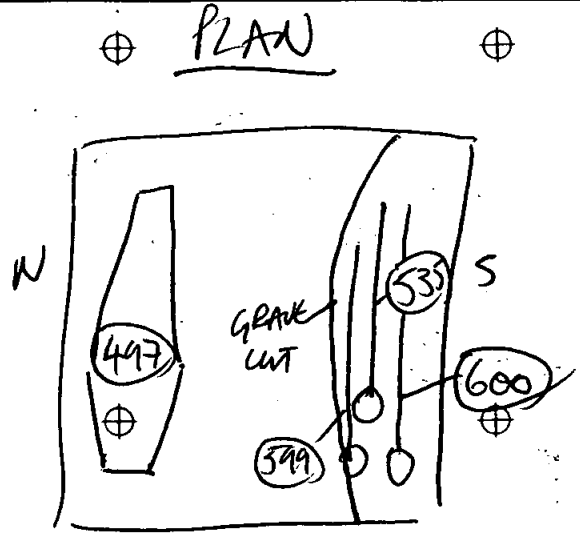

SITE OLR00.	CONTEXT RECORD ADDITIONAL SHEET	Context No 496
----------------	---------------------------------	-------------------

THE RE-USED (INSCRIBED) SLAB HAS CENTRAL MORTAR SCARS ON TOP, PRESUMABLY THE FOOTINGS OF A TOMB MONUMENT MARKING THE POSITION OF THE VAULT BELOW.

THE INSCRIPTION IS FAUNZ INTO THE TOMB + READS THUS: -

<p>Aged 28 years His dealings upright used dee The dearest brother & the be</p>	<p>/// /// ///</p>
<p>Also the Remains of Miss Ann WILLOUGHBY his Who died March the 27th 1756 Aged 6 years</p>	

(Presumably Stone Cut here to fit)

<p>Also the Remains of M W JACKSON father of the above who died Dec^r 23^d 1760 Aged 76</p>	<p>Vault top</p>
<p>Also the Remains of (Willoughby?) MRS CATH JACKSON MR W^m JACKSON who Decem^r 7th 1763 Age MRS CATH</p>	

(SEE NEXT ADD SHEET)

SITE

OLR00

CONTEXT RECORD ADDITIONAL SHEET

Context No.

496

After dismantling of vault, slab revealed:-

In Memory of
Mr Richard JACKSON

of this Parish who died
May the 25th 1736

His dealings upright used decet to none
The dearest Brother & the best of Sons

⊕ — ⊕ — ⊕ — ⊕
MRS CATHERINE JACKSON WILLOW
Mr W^m JACKSON who Died
Decem^r 7th 1763 Aged 77

⊕ Also Mrs CATHERINE LOWE ⊕
Daughter of the above Will^m and
CATHERINE JACKSON who Died

⊕ Feb^y 8th 1787 Aged 58 Years. ⊕

db.

SITE	COFFIN RECORD SHEET	CONTEXT NO.
0LR00		497
Trench: 5C	Additional sheets:	Treatment: SKELLY LIFTED - DNA TAKEN.
Site sub-div:	Grave fills	
Plan no: 6	Grave cut:	Finds None + ① □ P.6 Breastplate x 1 Fe (rect) ⑨ gilt lead Grip & plate x 1 = P ③ ④ Fe.
Section no:	Skeleton:	Hinge Bracket up studs Fixing nails - many Shroud pins
Co-ordinates:	Matrix location: in vault 496	Fabric ✓
Levels	Preservation: 4	Other finds: lid motifs ② (fixed w/ cur. alloy)
Slide No.	Neg No:	

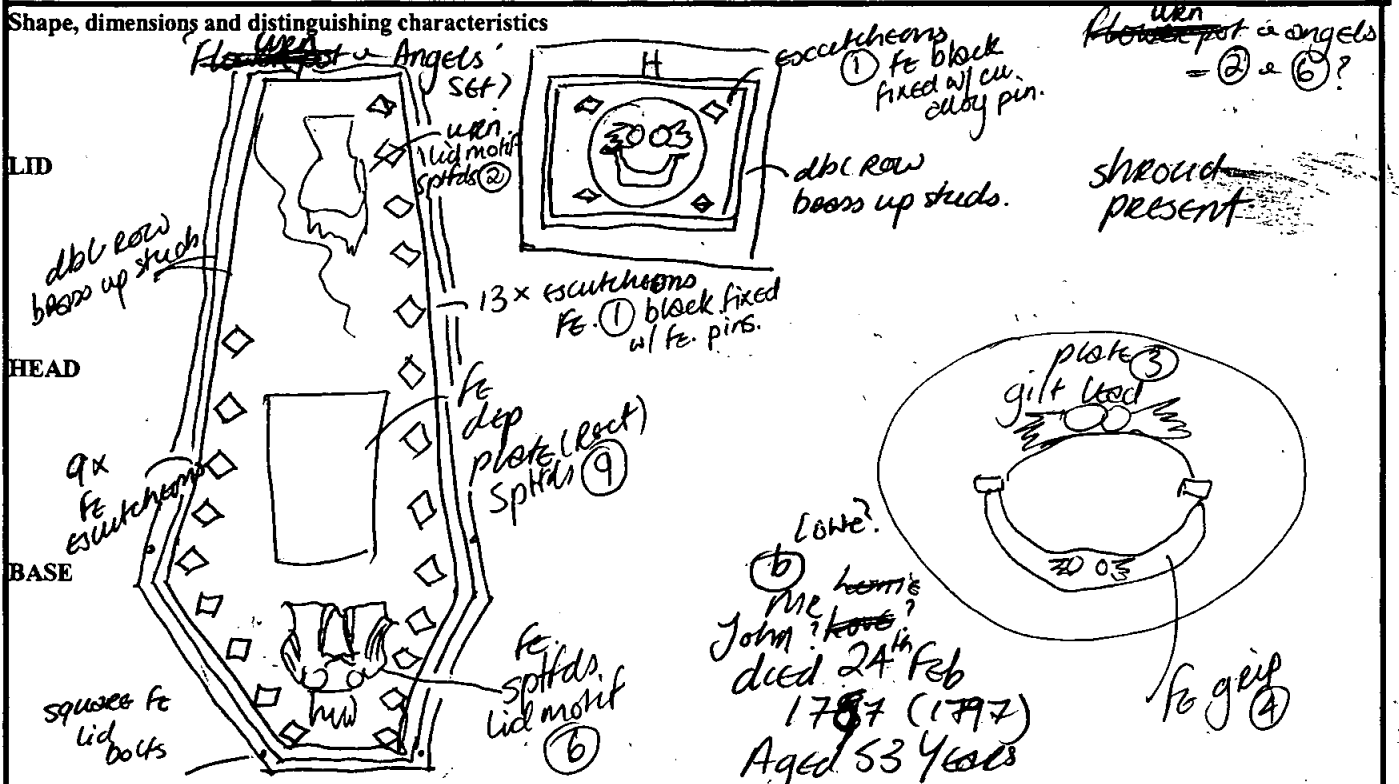
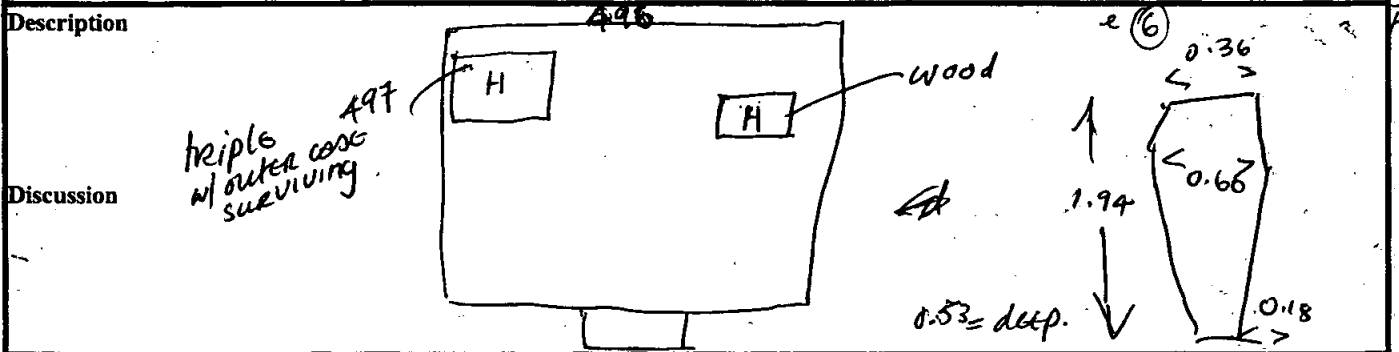

Recorder: Mel. Date: 6/10 Initials: MR