

Islington, Old Street, St Lukes  
ALROO

Box 3 file 1

B. PRIMARY CONTEXT RECORDS - N° 498-629

SCAN PDF

FILMING INSTRUCTIONS

Submitter OASouth

No. of CD copies: 2

Headings

Site information

Line 1: [OASouth] County:[Greater London] Parish:[Islington] Site:[Old Street, St Lukes]

Site code[OLR00]

Line 2: Excavators name[A. Boyle]

Line 3:

Classification of material

Tick if present

Index to archive	
Introduction	
A:Final Report	
A:Publication Report	
B:Site Data – Text: Diary/Daybook/Fieldnotes	
B: Site Data – Text: General Summaries	
B: Site Data – Text: Primary Context Records <i>Nº 498 → 629</i>	✓
B: Site Data – Text: Synthesised Context Records	
B: Site Data – Text: Survey Reports	
B: Site Data – Text: Catalogue of Drawings	
B: Site Data – Text: Primary Drawings	
B: Site Data – Text: Synthesised Drawings	
C: Finds Data – Text: Primary Finds Data	
C: Finds Data – Text: Synthesised Finds Data	
C: Finds Data – Text: Specialist Reports	
C: Finds Data – Text: Box/Bag List	
D: Catalogue of Photos/Slides/Videos/X--rays	
E: Environmental/Ecofact Data: Primary Records	
E: Environmental/Ecofact Data: Synthesised Records	
E: Environmental/Ecofact Data: Specialist Reports	
F: Documentary	
F: Press and Publicity	
G: Correspondence	
H: Miscellaneous	

SITE		CONTEXT				SITE		Matrix NAME	Comments
CODE:		CHECKLIST				NAME:			
Context No	Type	Excavated with Segments	Relationships	Dug	Drawn				
					Section	Plan			
B 498	BURIAL	NC	u/lies 463 o/lies 502	AN/DH		3		ADULT.	
B 499	BURIAL	NC				3		ADULT.	
B 500	BURIAL	NC				3		ADULT	
B 501	I.I.	NC	Truncates 500			"		ADULT	
B 502	"	"	u/lies 498 o/lies 504			"		ADULT	
B 503	"	"						"	
B 504	"		u/lies 502 o/lies 505					CHILD/JUVENILE	
B 505	"		u/lies 507					"	
B 506	"							ADULT	
B 507	"		o/lies 509					ADULT / ADOLESCENT?	
B 508	"		u/lies 509					ADULT	
B 509	"		o/lies 508 u/lies 507					"	
B 510	"		o/lies 511					"	
B 511	"		u/lies 510					"	
B 512	"		NONE					ADULT	
DVA B 513	"		NONE				Y	ADULT - LEAN-	
B 514	"		o/lies 519					ADULT	
B 515	"		o/lies 517 u/lies 518					ADULT	
B 516	"		o/lies 518					BABY	
B 517	"		u/lies 515					ADULT	
B 518	"		u/lies 516 o/lies 515					BABY	
B 519	"		u/lies 514 u/lies 520					ADULT	
B 520	"		u/lies 519					"	
B 521	"		o/lies 520					"	
B 522	"		NONE					"	
B 523	"		o/lies 524					"	
B 524	"		u/lies 523 u/lies 525					"	
B 525	"		u/lies 524					"	
B 526	"		o/lies 527					ADULT	
B 527	"		o/lies 524 u/lies 526					ADULT	
B 528	"		o/lies 529					JUVENILE	
B 529	"		o/lies 530 u/lies 528					ADULT	
B 530	"		u/lies 529 o/lies 565					ADULT	

SITE CODE:		CONTEXT CHECKLIST			SITE NAME:			
Context No	Type	Excavated with Segments	Relationships	Dug	Drawn		Matrix named?	Comments
					Section	Plan		
531	BURIAL	CRYPT	in Bay 3	DS		7	Y	p.b. coffin
532	BURIAL	CRYPT		DS		7	Y	p.b. coffin
533	BURIAL	CRYPT		DS		7	Y	p.b. coffin
534	BURIAL	CRYPT	u/356	DS		7	Y	p.b. coffin
535	BURIAL	SC	in vault 496			6	N	wood coffin
536	BURIAL	CRYPT	in Bay 4	Th		7	Y	Pb Coffin
537	BURIAL	CRYPT		"		7	Y	"
538	BURIAL	CRYPT		"		7	Y	"
539	BURIAL	CRYPT		"		7	Y	"
540	BURIAL	"		Th		7	Y	"
541	BURIAL	"		"		7	Y	"
542	BURIAL	"		"		7	Y	"
543	BURIAL	"		"		7	Y	"
544	STRUC	N.C.		DS		3		Brick support for ledges
545	STRUC	N.C.						Slab/brick support for ledger/monument
546	STRUC	N.C.						Brick base for ledger or monument
547	STRUC	N.C.						"
548	STRUC	N.C.						"
549	STRUC	N.C.						"
550	STRUC	N.C.						Stone base for monument.
551	STRUC	N.C.						Brick base for ledger or monument
552	STRUC	N.C.						"
553	STRUC	N.C.						"
554	STRUC	N.C.						Stone/brick base for ledges/monument
555	STRUC	N.C.	Contains under (3) 460					BRICK GRAVE
556	<del>STRUC</del>	<del>N.C.</del>	VOID					VOID
557	STRUC	N.C.						BRICK GRAVE
558	STRUC	N.C.						ledger stone support slab? monument base?
559	STRUC	N.C.	Part part of vault floor					Part entrance well for vault 109
560	STRUC	N.C.						manhole ???
561	STRUC	N.C.						Stone support for ledger or monument base
562	STRUC	N.C.		↓		↓		Truncated support for ledger/monument
563	BURIAL	CRYPT	in Bay 4	mejos		7	Y	p.b. coffin

DNA/B

B

JNB

JNB

JNB

DNA/B

DNA/B

DNA/B

DNA

DNA

DNA/B



SITE <b>OLR 00</b>		CONTEXT			SITE <b>ST WINE'S</b>			
CODE:		CHECKLIST			NAME:			
Context No	Type	Excavated with Segments	Relationships	Dug	Drawn		Matrix	Comments
					Section	Plan		
B 564	BURIAL	NC	u/lies 527 o/lies 565	OR/AN OMC		3		ADULT
B 565	"		u/lies 564					"
B 566	"		o/lies 567 u/lies 530					"
B 567	"		u/lies 566					"
B 568	"							CHILD
B 569	"		o/lies 571					ADULT
B 570	"		u/lies 521					ADULT
B 571	"		u/lies 569					ADULT
B 572	"		o/lies 573					ADULT - NO SKULL
B 573	"		u/lies 572					ADULT
B 574	"		u/lies 573					ADULT.
B 575	"		o/lies 576					"
B 576	"		u/lies 575					"
B 577	"		<del>u/lies 577</del>					BABY
B 578	"		<del>u/lies 578</del>					ADULT
B 579	"		o/lies 580 u/lies 578					ADULT
B 580	"		u/lies 581 u/lies 579					ADULT
B 581	"		u/lies 580					ADULT
B 582	STRUC							CHURCH 'REPAIR'
B 583	STRUC							CHURCH 'REPAIR'
B 584	BURIAL		o/l 585					ADULT
B 585	"		o/l 586 u/l 584					ADULT
B 586	"		u/l 585 o/l 587					ADULT.
B 587	"		u/l 586 o/l 588					ADULT.
B 588	"		u/l 587 o/l 589					ADULT.
B 589	"		u/l 588 o/l 595					ADULT
B 590	"		o/l 591					ADULT
B 591	"		u/l 590					ADULT - BONE GROWTH SHAN
B 592	"		<del>u/l 592</del> Trunc. by 594					ADULT.
B 593	"		u/l 591 o/l 594					ADULT
B 594	"		u/l 593					ADULT
B 595	"		u/l 589					ADULT
B 596	"		o/l 630					ADULT.

BURIALS THIS PAGE = 31

SITE OLR 00		CONTEXT			SITE ST LUKE'S CHURCH			
CODE:		CHECKLIST			NAME: ISCINGTON.			
Context No	Type	Excavated with Segments	Relationships	Dug	Drawn		Matrix <i>removed</i>	Comments
					Section	Plan		
DNA/B 597	Burial Crypt		in Bay A	MR/DS		7	Y	p.b. coffin
B 598	Burial Crypt		in Bay A	MR/DS		7		p.b. coffin
B 599	Burial SC	V. 496	V. 496	T <sub>2</sub>		6		wood coffin (remains of)
DNA/B 600	BURIAL SC		V. 496	T <sub>2</sub>		6	Y	wood coffin (remains of)
DNA/B 601	BURIAL CRYPT		ADJ. V. 15	DS		7	Y	p.b. coffin
DNA/B 602	BURIAL CRYPT		ADJ. V. 15	DS		7	Y	p.b. coffin
B 603	BURIAL CRYPT			T <sub>2</sub>		7	Y	p.b. Coffin
B 604	BURIAL SC		V. 411	T <sub>2</sub>		6		wood coffin
B 605	BURIAL SC		V. III	T <sub>2</sub>		6		wood coffin
B 606	BURIAL SC		V. III	T <sub>2</sub>		6		wood coffin
B 607	Burial SC		w/ 605	M/D		6		wood coffin
B 608	Burial SC		w/ 606	M/D		6		wood coffin
DNA/B 609	BURIAL SC		V. III w/ 608	M/T <sub>2</sub>		6	Y	wood coffin
DNA/B 610	BURIAL CRYPT		Bay 2	T <sub>2</sub>		7	Y	Pb Coffin
- 611	BURIAL CRYPT		BAY 2	T <sub>2</sub>		7	Y	Pb Coffin
- 612	BURIAL CRYPT		BAY 3	MR/DS		7	Y	Pb coffin
- 613	BURIAL CRYPT		BAY 3	MR/DS		7	Y	Pb coffin
DNA/B 614	BURIAL CRYPT		BAY 3	MR/DS		7	Y	Pb coffin
DNA/B 615	BURIAL NC			JR		3		Burial
DNA/B 616	Burial Crypt		Bay 3			7	Y	
DNA/B 617	Burial Crypt		Bay 2			7	Y	
DNA/B 618	Burial Crypt		Bay 2			7	Y	
DNA/B 619	Burial SC		in vault 126 w/ 620	DS		6	Y	p.b. coffin
DNA/B 620	Burial SC		w/ 619	DS		6	Y	<del>p.b.</del> coffin
DNA/B 621	Burial SC		w/ 620	DS		6	Y	p.b. coffin
DNA/B 622	Burial SC		w/ 621	DS		6	Y	p.b. coffin.
DNA/B 623	BURIAL CRYPT		n/603 (BAY 3)	T <sub>2</sub>		7	Y	Pb Coffin
B 624	BURIAL		w/ 593/594 (3)	"		"	N	"
- 625	BURIAL		w/ 626 (3)	"		"	Y	"
DNA/B 626	BURIAL		n 551 w/ 625 (3)	"		"	Y	"
- 627	BURIAL		591 (3)	"		"	N	"
DNA/B 628	BURIAL		(3)	"		"	Y	"
DNA/B 629	BURIAL		(3)	"		"	Y	"

END WK 14

db

SITE <i>OLR 00</i>		COFFIN RECORD SHEET	CONTEXT NO. <i>498</i>
Trench:	Additional sheets: <i>YES x1</i>	Treatment: <i>Bones collected.</i>	
Site sub-div: <i>NZ</i>	Grave fills: <i>-</i>		
Plan no: <i>3</i>	Grave cut: <i>-</i>	Finds None	
Section no:	Skeleton: <i>498</i>	Breastplate Grip	
Co-ordinates:	Matrix location: <i>462</i> <i>463</i> <i>498</i>	Hinge Bracket	
Levels	Preservation: <i>FAIR 502.</i>	Fixing nails Shroud pins	
Slide No.	Neg No:	Fabric Other finds	
Description <i>E-W admt brial, underlying 463, overlying 502.</i>			
Discussion			
Shape, dimensions and distinguishing characteristics			
LID			
HEAD			
BASE			
Recorder: <i>D. Hull.</i>	Date: <i>5.10.00.</i>	Initials:	

# Coffin Recording Sheet

**Outer Coffin**

Sample Ret.

Site Code

Context

OR100

498

Recording Date ..... 15/11/00 .....

Associated Numbers .....

Condition .....

Dep. Plate

Legible

Inscription

Fabric lead       ormolou       brass       tin plated pewter       gilt tin   
 iron       silvered tin       enamelled       other .....      Sample Ret.

**Shape of dep. plate**

square       rectangle       shield       tapered       lozenge   
 cartouche       oval       other .....

**Upholstery**

colour .....      shoddy       velvet       other .....      Sample Ret.

**Construction**

butt joint       mitred       pitched       other .....

**Grip plate**       Fabric = ormolou       brass       tin plated pewter       gilt tin   
 iron       silvered tin       enamelled       other .....      Sample Ret.

**Grip**       Fabric = ormolou       brass       iron  *x4*      Sample Ret.

**Design**      swag of rose       horseshoe       cherub's head  <sup>①</sup>      plain

other .....

**Grip bolts**       **Corner bolts**       Type =      gilt brass       brass       iron

other .....      Sample Ret.

**Lid motifs**       other .....

Sample Ret.

**Escutcheons**       other .....

Sample Ret.

**Upholstery** <sup>studs</sup>       brass       gilt brass       silvered brass       iron  *x2* <sup>pieces</sup>      enamelled

other ..... *1 x 000 / 1 x 0000 = 7 studs total.* .....      Sample Ret.

**Fixings**       panel nails       screws       hinges       lace       Sample Ret.

**Timber type** .....      Sample Ret.

**Interpretation / Comments**

.....  
 .....

SITE		COFFIN RECORD SHEET		CONTEXT NO. 499	
Trench:		Additional sheets:		Treatment:	Bones collected
Site sub-div:	NC	Grave fills:	/		
Plan no:	3	Grave cut:	/	Finds:	None
Section no:		Skeleton:	499	Breastplate:	
Co-ordinates:		Matrix location:		Grip:	
Levels:		Preservation:	FAIR/GOOD.	Hinge:	
Slide No.:		Neg No.:		Bracket:	
				Fixing nails:	
				Shroud pins:	
				Fabric:	
				Other finds:	
<b>Description</b> E-W adult burial right arm slightly truncated away by machine.					
<b>Discussion</b>					
<b>Shape, dimensions and distinguishing characteristics</b>					
<b>LID</b>					
<b>HEAD</b>					
<b>BASE</b>					
Recorder:	D. Hull	Date:	5.10.00	Initials:	



SITE <i>OLR 00</i>	COFFIN RECORD SHEET	CONTEXT NO. <i>500</i>
Trench:	Additional sheets:	Treatment: <i>Bones collected</i>
Site sub-div: <i>NL</i>	Grave fills: <i>-</i>	
Plan no: <i>3</i>	Grave cut: <i>-</i>	Finds None
Section no:	Skeleton: <i>500</i>	Breastplate Grip
Co-ordinates:	Matrix location: <i>500 truncated by 501 501</i>	Hinge Bracket
Levels:	Preservation: <i>BOX / FAUL.</i>	Fixing nails Shroud pins
Slide No.:	Neg No.:	Fabric Other finds

Description *E-W Adult burial - truncated away by cut for 462, 463 + 498 from to distal end of femurs. These survive along with tibiae + fibulae, feet too deep in section at present - retrieval fairly unlikely. Main body truncated by 501*

Discussion

Shape, dimensions and distinguishing characteristics

LID

HEAD

BASE

Recorder: <i>D. Hewl</i>	Date: <i>5.10.00.</i>	Initials:
--------------------------	-----------------------	-----------

db.

SITE	COFFIN RECORD SHEET	CONTEXT NO.
OLR 00	Additional sheets: YESx1	501 Treatment: Bones collected.
Trench:	Grave fills /	
Site sub-div: NC	Grave cut: /	Finds
Plan no: 3	Skeleton: 501	None
Section no:	Matrix location: 501 500	Breastplate
Co-ordinates:	Preservation: Good.	Grip ✓
Levels	Slide No.	Hinge
Slide No.	Neg No:	Bracket
Description		Fixing nails
Discussion		Shroud pins
Shape, dimensions and distinguishing characteristics		Fabric
LID		Other finds
HEAD		
BASE		
Recorder: DH	Date: 5-10-00.	Initials:

**Outer Coffin**

Sample Ret.

Site Code

Context

OL200

501

Recording Date ..... 16/11/00 .....

Associated Numbers .....

Condition .....

Dep. Plate

Legible

Inscription

Fabric lead       ormolou       brass       tin plated pewter       gilt tin   
 iron       silvered tin       enamelled       other .....      Sample Ret.

**Shape of dep. plate**

square       rectangle       shield       tapered       lozenge   
 cartouche       oval       other .....

**Upholstery**

colour .....      shoddy       velvet       other .....      Sample Ret.

**Construction**

butt joint       mitred       pitched       other .....

**Grip plate**

Fabric = ormolou       brass       tin plated pewter       gilt tin

iron       silvered tin       enamelled       other .....      Sample Ret.

*frag on rev of grip.*

**Grip**

Fabric = ormolou       brass       iron  & A      Sample Ret.

**Design**

swag of rose       horseshoe       cherub's head  (A)'s      plain

other .....

**Grip bolts**

Corner bolts       Type = gilt brass       brass       iron

other .....      Sample Ret.

**Lid motifs**

other .....      Sample Ret.

**Escutcheons**

other .....      Sample Ret.

**Upholstery nails**

brass       gilt brass       silvered brass       iron       enamelled

other .....      Sample Ret.

**Fixings**

panel nails       screws       hinges       lace       Sample Ret.

**Timber type** .....

Sample Ret.

**Interpretation / Comments**

.....  
 .....

db

SITE <u>BLR 00</u>		COFFIN RECORD SHEET	CONTEXT NO. <u>502</u>
Trench:	Additional sheets: <u>YES x 1</u>	Treatment: <u>Bones collected.</u>	
Site sub-div: <u>NC</u>	Grave fills: <u>-</u>		
Plan no: <u>3</u>	Grave cut: <u>-</u>	Finds None	
Section no:	Skeleton: <u>S02</u>	Breastplate <input checked="" type="checkbox"/> Grip <input checked="" type="checkbox"/>	
Co-ordinates:	Matrix location: <u>498</u> <u>502</u> <u>504</u>	Hinge Bracket	
Levels	Preservation: <u>Good.</u>	Fixing nails Shroud pins	
Slide No.	Neg No:	Fabric Other finds	
Description <u>E-W Adult burial overlain by 498.</u>			
Discussion			
Shape, dimensions and distinguishing characteristics			
LID			
HEAD			
BASE			
Recorder: <u>D. Gray</u>	Date: <u>5-10-00</u>	Initials:	

**Outer Coffin**

Sample Ret.

Site Code

Context

Recording Date ..... *15/4/00* .....

*01200*

*502*

Associated Numbers .....

Condition ..... *1* .....

Dep. Plate

Legible  *NO*

Inscription *Too oxidised to read or id.*

Fabric lead  ormolou  brass  tin plated pewter  gilt tin   
 iron  silvered tin  enamelled  other ..... Sample Ret.

**Shape of dep. plate**

square  rectangle  shield  tapered  lozenge   
 cartouche  oval  other .....

**Upholstery**

colour ..... shoddy  velvet  other ..... Sample Ret.

**Construction**

butt joint  mitred  pitched  other .....

Grip plate  Fabric = ormolou  brass  tin plated pewter  gilt tin   
 iron  silvered tin  enamelled  other ..... Sample Ret.

Grip  Fabric = ormolou  brass  iron  *x1* A Sample Ret.

Design swag of rose  horseshoe  cherub's head  plain

other .....

Grip bolts  Corner bolts  Type = gilt brass  brass  iron

other ..... Sample Ret.

Lid motifs  other ..... Sample Ret.

Escutcheons  other ..... Sample Ret.

Upholstery nails  brass  gilt brass  silvered brass  iron  enamelled

other ..... Sample Ret.

Fixings  panel nails  screws  hinges  lace  Sample Ret.

Timber type ..... Sample Ret.

**Interpretation / Comments**

.....  
 .....



db

SITE	COFFIN RECORD SHEET		CONTEXT NO.
OLR00	Additional sheets: YES x1		503
Trench:	Grave fills	Treatment: BONES COLLECTED	
Site sub-div: NC	Grave cut:	Finds	
Plan no: 3	Skeleton: 503	None	
Section no:	Matrix location:	Breastplate	
Co-ordinates:	Preservation: FAIR	Grip	
Levels	Neg No:	Hinge	
Slide No.	Shape, dimensions and distinguishing characteristics		Bracket
Description: E-W Adult, truncated only lower legs & feet.			
Discussion			
LID			
HEAD			
BASE			
Recorder: <i>[Signature]</i>	Date: 5/10/00	Initials:	

# Coffin Recording Sheet

**Outer Coffin**

Sample Ret.

Site Code

Context

Recording Date ..... *15/11/00* .....

*02200*

*503*

Associated Numbers .....

Condition .....

Dep. Plate

Legible

Inscription

Fabric lead  ormolou  brass  tin plated pewter  gilt tin   
 iron  silvered tin  enamelled  other ..... Sample Ret.

**Shape of dep. plate**

square  rectangle  shield  tapered  lozenge   
 cartouche  oval  other .....

**Upholstery**

colour ..... shoddy  velvet  other ..... Sample Ret.

**Construction**

butt joint  mitred  pitched  other .....

Grip plate  Fabric = ormolou  brass  tin plated pewter  gilt tin   
 iron  silvered tin  enamelled  other ..... Sample Ret.

Grip  Fabric = ormolou  brass  iron  *x2* Sample Ret.

Design swag of rose  horseshoe  cherub's head  plain   
 other ..... *infant → 0.11 ↓ 0.05 unid*

Grip bolts  Corner bolts  Type = gilt brass  brass  iron   
 other ..... Sample Ret.

Lid motifs  other ..... Sample Ret.

Escutcheons  other ..... Sample Ret.

Upholstery nails  brass  gilt brass  silvered brass  iron  enamelled   
 other ..... Sample Ret.

Fixings  panel nails  screws  hinges  lace  Sample Ret.

Timber type ..... Sample Ret.

**Interpretation / Comments**

.....  
 .....

dlb.

SITE <i>BLR 00</i>		COFFIN RECORD SHEET		CONTEXT NO. <i>504</i>	
Trench:		Additional sheets: <i>YES x1</i>		Treatment: <i>Bones collected.</i>	
Site sub-div: <i>NL</i>		Grave fills <i>/</i>			
Plan no: <i>3</i>		Grave cut: <i>/</i>		Finds None	
Section no:		Skeleton: <i>504</i>		Breastplate Grip <input checked="" type="checkbox"/>	
Co-ordinates:		Matrix location: <i>502</i> <i>504</i>		Hinge Bracket	
Levels		Preservation: <i>FAIR 505</i>		Fixing nails Shroud pins	
Slide No.		Neg No:		Fabric Other finds	
Description <i>E-W child/Juvenile burial, below 502. Middle of body + most of arms truncated away by 502.</i>					
Discussion					
Shape, dimensions and distinguishing characteristics					
LID					
HEAD					
BASE					
Recorder: <i>D. Hall</i>		Date: <i>5-10-00</i>		Initials:	

# Coffin Recording Sheet

**Outer Coffin**

Sample Ret.

Site Code

Context

Recording Date 13/11/00

*Ohloo*

*SOA*

Associated Numbers .....

Condition .....

Dep. Plate

Legible

Inscription

Fabric lead  ormolou  brass  tin plated pewter  gilt tin   
 iron  silvered tin  enamelled  other ..... Sample Ret.

**Shape of dep. plate**

square  rectangle  shield  tapered  lozenge   
 cartouche  oval  other .....

**Upholstery**

colour ..... shoddy  velvet  other ..... Sample Ret.

**Construction**

butt joint  mitred  pitched  other .....

**Grip plate**  Fabric = ormolou  brass  tin plated pewter  gilt tin   
 iron  silvered tin  enamelled  other ..... Sample Ret.

*legs on rev of grip*

**Grip**  Fabric = ormolou  brass  iron  x 2 Sample Ret.

**Design**

swag of rose  horseshoe  cherub's head  plain

other ..... *infant ←→ 0.11 ↓ 0.05*

**Grip bolts**  **Corner bolts**  **Type =** gilt brass  brass  iron

other ..... Sample Ret.

**Lid motifs**  other ..... Sample Ret.

**Escutcheons**  other ..... Sample Ret.

**Upholstery nails**  brass  gilt brass  silvered brass  iron  enamelled

other ..... Sample Ret.

**Fixings**  panel nails  screws  hinges  lace  Sample Ret.

**Timber type** ..... Sample Ret.

**Interpretation / Comments**

.....  
 .....

SITE		COFFIN RECORD SHEET		CONTEXT NO.	
0LR00				505	
Trench:		Additional sheets:		Treatment:	
Site sub-div: NC		Grave fills		BONES COLLECTED	
Plan no: 3		Grave cut:		Finds	
Section no:		Skeleton: 505		None	
Co-ordinates:		Matrix location: 504 505		Breastplate	
Levels		Preservation: GOOD		Grip	
Slide No.		Neg No:		Hinge	
				Bracket	
				Fixing nails	
				Shroud pins	
				Fabric	
				Other finds	
Description					
E-W CHILD BURIAL, RECOVERED FROM MACHING BUCKET, NOT COMPLETE					
Discussion					
Shape, dimensions and distinguishing characteristics					
LID					
HEAD					
BASE					
Recorder: [Signature]		Date: 5/10/00		Initials:	



db

SITE DLR00		COFFIN RECORD SHEET		CONTEXT NO. 506	
Trench:		Additional sheets: 483 x 1		Treatment: BONES COLLECTED	
Site sub-div: NC		Grave fills			
Plan no: 3		Grave cut:		Finds None	
Section no:		Skeleton: 506		Breastplate Grip ✓	
Co-ordinates:		Matrix location:		Hinge Bracket	
Levels		Preservation: FAIR		Fixing nails Shroud pins	
Slide No.		Neg No:		Fabric Other finds:	
Description S-W ADULT FRAGMENTARY AROUND PELVIS					
Discussion					
Shape, dimensions and distinguishing characteristics					
LID					
HEAD					
BASE					
Recorder: [Signature]		Date: 5/10/00		Initials:	

# Coffin Recording Sheet

Site Code

Context

**Outer Coffin**

Sample Ret.

02200

506

Recording Date ..... 15/11/00

Associated Numbers .....

Condition .....

Dep. Plate

Legible

Inscription

**Fabric** lead  ormolou  brass  tin plated pewter  gilt tin   
 iron  silvered tin  enamelled  other ..... Sample Ret.

**Shape of dep. plate**

square  rectangle  shield  tapered  lozenge   
 cartouche  oval  other .....

**Upholstery**

colour ..... shoddy  velvet  other ..... Sample Ret.

**Construction**

butt joint  mitred  pitched  other .....

**Grip plate**  **Fabric =** ormolou  brass  tin plated pewter  gilt tin   
 iron  silvered tin  enamelled  other ..... Sample Ret.

**Grip**  **Fabric =** ormolou  brass  iron  x1 Sample Ret.

**Design** swag of rose  horseshoe  cherub's head  4 plain

other .....

**Grip bolts**  **Corner bolts**  **Type =** gilt brass  brass  iron

other ..... Sample Ret.

**Lid motifs**  other ..... Sample Ret.

**Escutcheons**  other ..... Sample Ret.

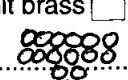
**Upholstery** <sup>studs</sup> nails  <sup>1 x piece</sup> brass  gilt brass  silvered brass  iron  black enamelled   
 other .....  = 16 studs total Sample Ret.

**Fixings**  panel nails  screws  hinges  lace  Sample Ret.

**Timber type** ..... Sample Ret.

**Interpretation / Comments**

.....  
 .....

116.

SITE OLROC	COFFIN RECORD SHEET	CONTEXT NO. 507
Trench:	Additional sheets: YESX1	Treatment:
Site sub-div: NC	Grave fills	BONE COLLECTED
Plan no: 3	Grave cut:	Finds None
Section no:	Skeleton: 507	Breastplate Grip ✓
Co-ordinates:	Matrix location: 507 509	Hinge Bracket
Levels	Preservation: GOOD	Fixing nails Shroud pins
Slide No.	Neg No:	Fabric Other finds

Description  
 GW ADULT TRUNCATED BY 1970S REPAIR.

Discussion

Shape, dimensions and distinguishing characteristics

LID

HEAD

BASE

Recorder: JK	Date: 5/10/00	Initials:
--------------	---------------	-----------

Site Code

Context

**Outer Coffin**

Sample Ret.

OH00

507

Recording Date ..... 15/11/00 .....

Associated Numbers .....

Condition .....

Dep. Plate

Legible

Inscription

Fabric lead  ormolou  brass  tin plated pewter  gilt tin   
 iron  silvered tin  enamelled  other ..... Sample Ret.

**Shape of dep. plate**

square  rectangle  shield  tapered  lozenge   
 cartouche  oval  other .....

**Upholstery**

colour ..... shoddy  velvet  other ..... Sample Ret.

**Construction** butt joint  mitred  pitched  other .....

**Grip plate**  Fabric = ormolou  brass  tin plated pewter  gilt tin   
*Feeds on rev of grip*  
 iron  silvered tin  enamelled  other ..... Sample Ret.

**Grip**  Fabric = ormolou  brass  iron  x3. Sample Ret.

**Design** swag of rose  horseshoe  cherub's head  plain   
*some as 2280 but bigger: 0.07 ← 0.22*  
 other .....

**Grip bolts**  **Corner bolts**  **Type =** gilt brass  brass  iron

other ..... Sample Ret.

**Lid motifs**  other ..... Sample Ret.

**Escutcheons**  other ..... Sample Ret.

**Upholstery nails**  brass  gilt brass  silvered brass  iron  enamelled

other ..... Sample Ret.

**Fixings**  panel nails  screws  hinges  lace  Sample Ret.

**Timber type** ..... Sample Ret.

**Interpretation / Comments**

.....  
 .....

abb.

SITE <u>04200</u>		COFFIN RECORD SHEET	CONTEXT NO. <u>508</u>
Trench:	Additional sheets: <u>YES x 1</u>	Treatment: <u>BUNG COLLECTED</u>	
Site sub-div: <u>NC</u>	Grave fills		
Plan no: <u>3</u>	Grave cut:	Finds None	
Section no:	Skeleton: <u>508</u>	Breastplate Grip	
Co-ordinates:	Matrix location: <u>509</u> <u>1</u> <u>508</u>	Hinge Bracket	
Levels	Preservation: <u>GOOD</u>	Fixing nails Shroud pins	
Slide No.	Neg No:	Fabric Other finds	
Description <u>E-W ADULT</u>			
Discussion			
Shape, dimensions and distinguishing characteristics			
LID			
HEAD			
BASE			
Recorder: <u>JR</u>	Date: <u>5/10/00</u>	Initials:	



Site Code

Context

01200

508

Outer Coffin

Sample Ret.

Recording Date *16/11/00*

Associated Numbers .....

Condition .....

Dep. Plate

Legible

Inscription

Fabric lead  ormolou  brass  tin plated pewter  gilt tin   
 iron  silvered tin  enamelled  other ..... Sample Ret.

Shape of dep. plate

square  rectangle  shield  tapered  lozenge   
 cartouche  oval  other .....

Upholstery

colour ..... shoddy  velvet  other ..... Sample Ret.

Construction

butt joint  mitred  pitched  other .....

Grip plate  Fabric = ormolou  brass  tin plated pewter  gilt tin   
 iron  silvered tin  enamelled  other ..... Sample Ret.

*frag on RT of grip unid*

Grip  Fabric = ormolou  brass  iron  **(36)** Sample Ret.

Design

swag of rose  horseshoe  cherub's head  plain

other .....

Grip bolts  Corner bolts  Type = gilt brass  brass  iron

other ..... Sample Ret.

Lid motifs  other ..... Sample Ret.

Escutcheons  other ..... Sample Ret.

Upholstery <sup>*studs*</sup> ~~nails~~  brass  gilt brass  silvered brass  iron  enamelled

other ..... *3 single studs conc. to for grip* Sample Ret.

Fixings  panel nails  screws  hinges  lace  Sample Ret.

Timber type ..... Sample Ret.

Interpretation / Comments

.....  
 .....

SITE	COFFIN RECORD SHEET	CONTEXT NO. 509
Trench: OL200	Additional sheets:	Treatment:
Site sub-div: WC	Grave fills	BONES COLLECTED
Plan no: 3	Grave cut:	Finds None
Section no:	Skeleton:	Breastplate Grip
Co-ordinates:	Matrix location: 507 509 508	Hinge Bracket
Levels	Preservation: GOOD	Fixing nails Shroud pins
Slide No.	Neg No:	Fabric Other finds
<p>Description 6-W ADULT ONLY L. ARM TRUNCATED BY 507</p> <p>Discussion</p>		
<p>Shape, dimensions and distinguishing characteristics</p> <p>LID</p> <p>HEAD</p> <p>BASE</p>		
Recorder: [Signature]	Date: 5/10/00	Initials:

SITE <u>OLROU</u>		COFFIN RECORD SHEET	CONTEXT NO. <u>510</u>
Trench:	Additional sheets:	Treatment: <u>BONE COLLECTED</u>	
Site sub-div: <u>NC</u>	Grave fills		
Plan no: <u>3</u>	Grave cut:	Finds None	
Section no:	Skeleton: <u>510</u>	Breastplate Grip	
Co-ordinates:	Matrix location: <u>510</u> <u>511</u>	Hinge Bracket	
Levels	Preservation: <u>GOOD</u>	Fixing nails Shroud pins	
Slide No.	Neg No:	Fabric Other finds	
Description <u>G-W BURIAL L. SIDE MISSING</u>			
Discussion			
Shape, dimensions and distinguishing characteristics			
LID			
HEAD			
BASE			
Recorder: <u>MW</u>	Date: <u>5/10/00</u>	Initials:	

# Coffin Recording Sheet

Site Code

Context

**Outer Coffin**

Sample Ret.

OLR00

S10

Recording Date ..... 16/2/01

Associated Numbers .....

Condition .....

Dep. Plate

Legible

Inscription

Fabric lead  ormolou  brass  tin plated pewter  gilt tin   
 iron  silvered tin  enamelled  other ..... Sample Ret.

**Shape of dep. plate**

square  rectangle  shield  tapered  lozenge   
 cartouche  oval  other .....

**Upholstery**

colour ..... shoddy  velvet  other ..... Sample Ret.

**Construction**

butt joint  mitred  pitched  other .....

Grip plate  Fabric = ormolou  brass  tin plated pewter  gilt tin   
 iron  *fraggs on rev. of grip-wood.* silvered tin  enamelled  other ..... Sample Ret.

Grip  Fabric = ormolou  brass  iron  *X4* Sample Ret.

Design swag of rose  horseshoe  cherub's head  *①'s* plain   
 other .....

Grip bolts  Corner bolts  Type = gilt brass  brass  iron   
 other ..... Sample Ret.

Lid motifs  other ..... Sample Ret.

Escutcheons  other ..... Sample Ret.

Upholstery nails  brass  gilt brass  silvered brass  iron  enamelled   
 other ..... Sample Ret.

Fixings  panel nails  screws  hinges  lace  Sample Ret.

Timber type ..... Sample Ret.

**Interpretation / Comments**

.....  
 .....

SITE		COFFIN RECORD SHEET		CONTEXT NO. 511	
Trench: OLROO		Additional sheets:		Treatment:	
Site sub-div: NC		Grave fills		BONES COLLECTED	
Plan no: 3		Grave cut:		Finds	
Section no:		Skeleton: 511		None	
Co-ordinates:		Matrix location: S10 511		Breastplate	
Levels		Preservation: GOOD		Grip	
Slide No.		Neg No:		Hinge	
Description		6-W BURIAL		Bracket	
Discussion				Fixing nails	
Shape, dimensions and distinguishing characteristics				Shroud pins	
LID				Fabric	
HEAD				Other finds	
BASE					
Recorder: [Signature]		Date: 5/10/00		Initials:	

Site Code

Context

**Outer Coffin**

Sample Ret.

OHROO

511

Recording Date ..... 21/2/01 .....

Associated Numbers .....

Condition ..... ? .....

Dep. Plate

Legible  NO

Inscription *frags of flat, bordered plate - poss. of dep plate.*

Fabric lead  ormolou  brass  tin plated pewter  gilt tin   
 iron  ? silvered tin  enamelled  other ..... Sample Ret.

**Shape of dep. plate** ?

square  rectangle  shield  tapered  lozenge   
 cartouche  oval  other .....

**Upholstery**

colour ..... shoddy  velvet  other ..... Sample Ret.

**Construction**

butt joint  mitred  pitched  other .....

**Grip plate**

Fabric = ormolou  brass  tin plated pewter  gilt tin   
 iron  silvered tin  enamelled  other ..... Sample Ret.

**Grip**

Fabric = ormolou  brass  iron  Sample Ret.

**Design**

swag of rose  horseshoe  cherub's head  plain

other .....

**Grip bolts**

Corner bolts  Type = gilt brass  brass  iron

other ..... Sample Ret.

**Lid motifs**

other ..... Sample Ret.

**Escutcheons**

other ..... Sample Ret.

**Upholstery**

*studs*  
 brass  gilt brass  silvered brass  iron  enamelled

other ..... *2 pieces - 1x00/1x000* ..... Sample Ret.

**Fixings**

panel nails  screws  hinges  lace  Sample Ret.

**Timber type** .....

Sample Ret.

**Interpretation / Comments**

.....  
 .....

SITE 01200	COFFIN RECORD SHEET	CONTEXT NO. 512
Trench:	Additional sheets: YES x1	Treatment:
Site sub-div: NC	Grave fills	BONE COLLECTED
Plan no: B	Grave cut:	Finds
Section no:	Skeleton: 512	None
Co-ordinates:	Matrix location:	Breastplate
Levels	Preservation: Good	Grip
Slide No.	Neg No:	Hinge
		Bracket
		Fixing nails
		Shroud pins
		Fabric
		Other finds

Description

G-W ADULT

Discussion

Shape, dimensions and distinguishing characteristics

LID

HEAD

BASE

Recorder: <i>JW</i>	Date: 6/10/00	Initials:
---------------------	---------------	-----------

# Coffin Recording Sheet

Site Code

Context

04600

512

**Outer Coffin**

Sample Ret.

Recording Date ..... 13/2/01 .....

Associated Numbers .....

Condition .....

Dep. Plate

Legible

Inscription

**Fabric** lead  ormolou  brass  tin plated pewter  gilt tin   
iron  silvered tin  enamelled  other ..... Sample Ret.

**Shape of dep. plate**

square  rectangle  shield  tapered  lozenge   
cartouche  oval  other .....

**Upholstery**

colour ..... shoddy  velvet  other ..... Sample Ret.

**Construction**

butt joint  mitred  pitched  other .....

**Grip plate**

Fabric = ormolou  brass  tin plated pewter  gilt tin   
iron  1 x 228b silvered tin  enamelled  other ..... Sample Ret.

**Grip**

Fabric = ormolou  brass  (some size 00 732) iron  x1 2280 Sample Ret.

**Design**

swag of rose  horseshoe  cherub's head  plain

other .....

**Grip bolts**

**Corner bolts**  Type = gilt brass  brass  iron

other ..... Sample Ret.

**Lid motifs**

other ..... Sample Ret.

**Escutcheons**

other ..... Sample Ret.

**Upholstery nails**

brass  gilt brass  silvered brass  iron  enamelled

other ..... Sample Ret.

**Fixings**

panel nails  screws  hinges  lace  Sample Ret.

**Timber type** .....

Sample Ret.

**Interpretation / Comments**

.....  
.....



Site Code

Context

**Outer Coffin**

Sample Ret.

OH200

512

Recording Date ..... 16/2/01

Associated Numbers .....

Condition .....

Dep. Plate

Legible

Inscription

Fabric lead  ormolou  brass  tin plated pewter  gilt tin   
 iron  silvered tin  enamelled  other ..... Sample Ret.

**Shape of dep. plate**

square  rectangle  shield  tapered  lozenge   
 cartouche  oval  other .....

**Upholstery**

colour ..... shoddy  velvet  other *booke* ..... Sample Ret.

**Construction**

butt joint  mitred  pitched  other .....

**Grip plate**

Fabric = ormolou  brass  tin plated pewter  gilt tin   
 iron  *frags on rev of grip-wood* silvered tin  enamelled  other ..... Sample Ret.

**Grip**

Fabric = ormolou  brass  iron  *x2* Sample Ret.

**Design**

swag of rose  horseshoe  cherub's head  *(P)5* plain

other .....

**Grip bolts**

Corner bolts  Type = gilt brass  brass  iron

other ..... Sample Ret.

**Lid motifs**

other ..... Sample Ret.

**Escutcheons**

other ..... Sample Ret.

**Upholstery**

*studs*  brass  gilt brass  silvered brass  iron  enamelled

other *6 x pieces: 1 x 00000 / 1 x 000 / 1 x 80 / 2 x 0000 / 1 x 8-8 = 19 studs* ..... Sample Ret.

**Fixings**

panel nails  screws  hinges  lace  Sample Ret.

**Timber type**

..... Sample Ret.

**Interpretation / Comments**

.....  
 .....

db

SITE		COFFIN RECORD SHEET		CONTEXT NO.
7400		Additional sheets: YES x1.		513
Trench:		Grave fills	BONE COLLECTED	
Site sub-div:	NE	Grave cut:		
Plan no:	3	Skeleton:	513	
Section no:		Matrix location:		
Co-ordinates:		Preservation:	FAIR	
Levels		Neg No:		
Slide No.				
Description		E-W ADULT - LEAD COFFIN		Frilled 'punched lace' composite round skull-shroud remains.
Discussion		J.N.A. SAMPLES		
Shape, dimensions and distinguishing characteristics				
LID				
HEAD				
BASE				
Recorder:		Date:	6/10/00	Initials:

# Coffin Recording Sheet

Site Code

Context

OHROO

513

**Outer Coffin**

Sample Ret.

Recording Date ..... 1/11/00 .....

Associated Numbers .....

Condition .....

~~Dep. Plate~~

Legible

Inscription

*inscription plate  
removed from coffin (p.k.)*

*"MR / Thos Dennis / Died Nov  
27<sup>m</sup> / 1775 / In his 50<sup>th</sup> Year"*

Fabric lead       ormolou       brass       tin plated pewter       gilt tin   
iron       silvered tin       enamelled       other .....      Sample Ret.

**Shape of dep. plate**

square       rectangle  *plain (OO)*      shield       tapered       lozenge   
cartouche       oval       other .....

**Upholstery**

colour .....      shoddy       velvet       other .....      Sample Ret.

**Construction**

butt joint       mitred       pitched       other .....

**Grip plate**

Fabric = ormolou       brass       tin plated pewter       gilt tin

iron       silvered tin       enamelled       other .....      Sample Ret.

**Grip**

Fabric = ormolou       brass       iron       Sample Ret.

**Design**

swag of rose       horseshoe       cherub's head       plain

other .....

**Grip bolts**

Corner bolts       Type = gilt brass       brass       iron

other .....      Sample Ret.

**Lid motifs**

other .....

Sample Ret.

**Escutcheons**

other .....

Sample Ret.

**Upholstery nails**

brass       gilt brass       silvered brass       iron       enamelled

other .....      Sample Ret.

**Fixings**

panel nails       screws       hinges       lace       Sample Ret.

**Timber type** .....

Sample Ret.

**Interpretation / Comments**

.....  
.....

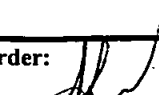
SITE 04700	COFFIN RECORD SHEET	CONTEXT NO. 514
Trench:	Additional sheets:	Treatment: BONE COLLECTED
Site sub-div: NC	Grave fills	
Plan no: 3	Grave cut:	Finds None
Section no:	Skeleton: 514	Breastplate Grip
Co-ordinates:	Matrix location: 514 519	Hinge Bracket
Levels	Preservation:	Fixing nails Shroud pins
Slide No.	Neg No:	Fabric Other finds
<p><b>Description</b> ADULT G-W HALF MACHINED AWAY AS PERHAPS BONES FOR KEITH IF AREA FINISHED BY</p> <p><b>Discussion</b> END OF TODAY, WHO KNOWS HOW MANY WE'VE ALREADY LOST</p>		
<p><b>Shape, dimensions and distinguishing characteristics</b></p> <p>LID</p> <p>HEAD</p> <p>BASE</p>		
Recorder: 	Date: 6/10/00	Initials:

db.

SITE OLR00	COFFIN RECORD SHEET	CONTEXT NO. 515
Trench:	Additional sheets: YES x 1	Treatment: BONE COLLECTED
Site sub-div: NC	Grave fills	
Plan no: 3	Grave cut:	Finds None
Section no:	Skeleton: 515	Breastplate Grip
Co-ordinates:	Matrix location: 516 518 515	Hinge Bracket
Levels	Preservation: 517 GOOD	Fixing nails Shroud pins
Slide No.	Neg No:	Fabric Other finds

Description  
6-W ADULT. ~~L. SIDE PROTRUSION~~ BY ~~ST~~  
518 MAY ~~BE~~ TRUNCATE.  
Discussion  
L. SIDE MISSING

Shape, dimensions and distinguishing characteristics

LID

HEAD

BASE

Recorder:	Date:	Initials:
-----------	-------	-----------

**Outer Coffin**

Sample Ret.

Site Code

Context

Recording Date ..... 10/10 .....

OH200

S15

Associated Numbers .....

Condition .....

Dep. Plate

Legible

Inscription

Fabric lead  ormolou  brass  tin plated pewter  gilt tin   
 iron  silvered tin  enamelled  other ..... Sample Ret.

**Shape of dep. plate**

square  rectangle  shield  tapered  lozenge   
 cartouche  oval  other .....

**Upholstery**

colour ..... shoddy  velvet  other ..... Sample Ret.

**Construction**

butt joint  mitred  pitched  other .....

Grip plate  Fabric = ormolou  brass  tin plated pewter  gilt tin   
 iron  silvered tin  enamelled  other ..... Sample Ret.

*frag on rev. of grip*

Grip  Fabric = ormolou  brass  iron  Sample Ret.

**Design**

swag of rose  horseshoe  cherub's head  plain

other ..... *conc.*

Grip bolts  Corner bolts  Type = gilt brass  brass  iron

other ..... Sample Ret.

Lid motifs  other ..... Sample Ret.

Escutcheons  other ..... Sample Ret.

Upholstery *studs*  brass  gilt brass  silvered brass  iron  X *5 pieces* enamelled   
 other ..... *1x 8.8 1x 000 1x 0 1x 800 1x 000000000 = 24 studs in total* Sample Ret.

Fixings  panel nails  screws  hinges  lace  Sample Ret.

Timber type ..... Sample Ret.

**Interpretation / Comments**

.....  
 .....

db

SITE 01200	COFFIN RECORD SHEET	CONTEXT NO. 516
Trench:	Additional sheets: YES X 1	Treatment: BONE COLLECTED
Site sub-div: NC	Grave fills	
Plan no: 3	Grave cut:	Finds None
Section no:	Skeleton: 516	Breastplate Grip
Co-ordinates:	Matrix location: 516 518	Hinge Bracket
Levels	Preservation: GOOD	Fixing nails Shroud pins
Slide No.	Neg No:	Fabric Other finds:

Description  
BABY BURIAL E-W MIXED WITH 518.  
516 IS THE SMALLER OF THE TWO

Discussion

Shape, dimensions and distinguishing characteristics

LID

HEAD

BASE

Recorder: JH	Date: 6/10/00	Initials:
--------------	---------------	-----------

Site Code

Context

02R00

516

**Outer Coffin**

Sample Ret.

Recording Date ..... 10/10 .....

Associated Numbers .....

Condition .....

Dep. Plate

Legible

Inscription

Fabric lead  ormolou  brass  tin plated pewter  gilt tin   
 iron  silvered tin  enamelled  other ..... Sample Ret.

**Shape of dep. plate**

square  rectangle  shield  tapered  lozenge   
 cartouche  oval  other .....

**Upholstery**

colour ..... shoddy  velvet  other ..... Sample Ret.

**Construction**

butt joint  mitred  pitched  other .....

Grip plate  Fabric = ormolou  brass  tin plated pewter  gilt tin   
 iron  silvered tin  enamelled  other ..... Sample Ret.

Grip  Fabric = ormolou  brass  iron  Sample Ret.

Design swag of rose  horseshoe  cherub's head  (conc.) plain   
 other ..... *intent grip terminal to terminal = 0.08 / drop = 0.03.*

Grip bolts  Corner bolts  Type = gilt brass  brass  iron   
 other ..... Sample Ret.

Lid motifs  other ..... Sample Ret.

Escutcheons  other ..... Sample Ret.

Upholstery nails  brass  gilt brass  silvered brass  iron  enamelled   
 other ..... Sample Ret.

Fixings  panel nails  screws  hinges  lace  Sample Ret.

Timber type ..... Sample Ret.

**Interpretation / Comments**

.....  
 .....



SITE	COFFIN RECORD SHEET	CONTEXT NO.
OLROU		517
Trench:	Additional sheets:	Treatment: BONE COLLECTED
Site sub-div: NL	Grave fills	
Plan no: 3	Grave cut:	Finds None
Section no:	Skeleton: 517	Breastplate Grip
Co-ordinates:	Matrix location: 515 517 <del>515</del>	Hinge Bracket
Levels	Preservation: GOOD	Fixing nails Shroud pins
Slide No.	Neg No:	Fabric Other finds
Description ADULT G-W <del>TRUSSESS</del> <del>SH</del>		
Discussion		
Shape, dimensions and distinguishing characteristics		
LID		
HEAD		
BASE		
Recorder: JH	Date: 6/10/00	Initials:

SITE	COFFIN RECORD SHEET		CONTEXT NO. 518
Trench: GLR00	Additional sheets:		Treatment:  BONE COLLECTED
Site sub-div: NL	Grave fills		
Plan no: 3	Grave cut:		Finds None
Section no:	Skeleton: 518		Breastplate Grip
Co-ordinates:	Matrix location: 516 518 515		Hinge Bracket
Levels	Preservation:		Fixing nails Shroud pins
Slide No.	Neg No:		Fabric Other finds
Description BABY 6-W MIXED WITH 516. (518) is LARGER THAN (516).			
Discussion			
Shape, dimensions and distinguishing characteristics			
LID			
HEAD			
BASE			
Recorder: [Signature]	Date: 6/10/00		Initials:



db

SITE	COFFIN RECORD SHEET	CONTEXT NO. 520
Trench: <i>OL 1502</i>	Additional sheets: <i>YESX1</i>	Treatment: <i>BUNGS COLLECTED</i>
Site sub-div: <i>NC</i>	Grave fills	
Plan no: <i>3</i>	Grave cut:	Finds None
Section no:	Skeleton: <i>520</i>	Breastplate Grip
Co-ordinates:	Matrix location: <i>517</i> <i>520</i>	Hinge Bracket
Levels	Preservation: <i>GOOD</i>	Fixing nails Shroud pins
Slide No.	Neg No:	Fabric Other finds

Description *G-W ADULT UNDER 519*

Discussion

Shape, dimensions and distinguishing characteristics

LID

HEAD

BASE

Recorder: *Jha*

Date: *6/10/00*

Initials:

# Coffin Recording Sheet

Site Code

Context

OL200

520

**Outer Coffin**

Sample Ret.

Recording Date ..... 10/10 .....

Associated Numbers .....

Condition .....

Dep. Plate

Legible

Inscription

Fabric lead       ormolou       brass       tin plated pewter       gilt tin   
 iron       silvered tin       enamelled       other .....      Sample Ret.

**Shape of dep. plate**

square       rectangle       shield       tapered       lozenge   
 cartouche       oval       other .....

**Upholstery**

colour .....      shoddy       velvet       other .....      Sample Ret.

**Construction**

butt joint       mitred       pitched       other .....

**Grip plate**  Fabric = ormolou       brass       tin plated pewter       gilt tin   
 iron       silvered tin       enamelled       other .....      Sample Ret.

*frags on rev. of grip.*

**Grip**  Fabric = ormolou       brass       iron       Sample Ret.

**Design**

swag of rose       horseshoe       cherub's head       *conc.*      plain

other .....

**Grip bolts**       **Corner bolts**       **Type =**      gilt brass       brass       iron

other .....      Sample Ret.

**Lid motifs**       other .....      Sample Ret.

**Escutcheons**       other .....      Sample Ret.

**Upholstery nails**       brass       gilt brass       silvered brass       iron       enamelled

other .....      Sample Ret.

**Fixings**       panel nails       screws       hinges       lace       Sample Ret.

**Timber type** .....      Sample Ret.

**Interpretation / Comments**

.....  
.....

SITE	COFFIN RECORD SHEET	CONTEXT NO.
06200		521
Trench:	Additional sheets:	Treatment:
Site sub-div: NC	Grave fills	BONE COLLECTED
Plan no: 3	Grave cut:	Finds
Section no:	Skeleton: 521	None
Co-ordinates:	Matrix location:	Breastplate
Levels	Preservation: GOOD	Grip
Slide No.	Neg No:	Hinge
		Bracket
		Fixing nails
		Shroud pins
		Fabric
		Other finds

Description  
G-W adult. V. deep so machined cut.

Discussion

Shape, dimensions and distinguishing characteristics

Additional bones:

LID  
L+R Tibia  
R shaft of Femur  
L Humerus  
R ulna  
L. prox. radius

HEAD  
L+R Fibulae  
Sternum  
R Os pubis ♀ - young (19-24)

BASE  
Sacrum ♀  
L4-T2  
R os coxa (♂)

Bones are gracile & fairly small. Very likely to be of the same individual but not 522 as it said on the skeletal bag, could be 526 or 527.

Recorder: JR	Date: 6/10/00	Initials:
--------------	---------------	-----------

# Coffin Recording Sheet

Site Code

Context

**Outer Coffin**

Sample Ret.

OLR00

521

Recording Date ..... 16/2/01 .....

Associated Numbers .....

Condition .....

Dep. Plate

Legible

Inscription

Fabric lead  ormolou  brass  tin plated pewter  gilt tin   
iron  silvered tin  enamelled  other ..... Sample Ret.

**Shape of dep. plate**

square  rectangle  shield  tapered  lozenge   
cartouche  oval  other .....

**Upholstery**

colour ..... shoddy  velvet  other *size* ..... Sample Ret.

**Construction**

butt joint  mitred  pitched  other .....

Grip plate  Fabric = ormolou  brass  tin plated pewter  gilt tin   
iron  *frag of cartouche on rev of grip-wood.* silvered tin  enamelled  other ..... Sample Ret.

Grip  Fabric = ormolou  brass  iron  *x2* Sample Ret.

Design swag of rose  horseshoe  cherub's head  *(3b)'s* plain   
other .....

Grip bolts  Corner bolts  Type = gilt brass  brass  iron   
other ..... Sample Ret.

Lid motifs  other ..... Sample Ret.

Escutcheons  other ..... Sample Ret.

Upholstery *studs*  brass  gilt brass  silvered brass  iron  enamelled   
other *1 x piece = 26 studs* ..... Sample Ret.

Fixings  panel nails  screws  hinges  lace  Sample Ret.

Timber type ..... Sample Ret.

**Interpretation / Comments**

.....  
.....

SITE	COFFIN RECORD SHEET	CONTEXT NO.
Trench: 0LR00	Additional sheets:	Treatment: 522
Site sub-div: NC	Grave fills	Bones collected
Plan no: 3	Grave cut:	Finds None
Section no:	Skeleton: 522	Breastplate <input checked="" type="checkbox"/> Grip
Co-ordinates:	Matrix location:	Hinge Bracket
Levels	Preservation: GOOD	Fixing nails Shroud pins
Slide No.	Neg No:	Fabric Other finds
<b>Description</b> G-W Adult U. deep so machined out.		
<b>Discussion</b>		
<b>Shape, dimensions and distinguishing characteristics</b>  LID  HEAD  BASE		
Recorder: [Signature]	Date: 6/10/00	Initials:



**Outer Coffin**

Sample Ret.

Site Code

Context

OLR00

522

Recording Date ..... 21/2/01 .....

Associated Numbers .....

Condition ..... 3 .....

Dep. Plate

Legible

Inscription "Lawrence Sidney/Esq<sup>re</sup>/Died 9<sup>th</sup> July/1768/Aged 62."  
*new type-see sheet.*

Fabric lead  ormolou  brass  tin plated pewter  gilt tin   
 iron  silvered tin  enamelled  other ..... Sample Ret.

*black polished.*

**Shape of dep. plate**

square  rectangle  shield  tapered  lozenge   
 cartouche  oval  other .....

**Upholstery**

colour ..... shoddy  velvet  other ..... Sample Ret.

**Construction**

butt joint  mitred  pitched  other .....

**Grip plate**

Fabric = ormolou  brass  tin plated pewter  gilt tin   
*lower portion of (29)*  
 iron  silvered tin  enamelled  other ..... Sample Ret.

**Grip**

Fabric = ormolou  brass  iron  x1 Sample Ret.

**Design**

swag of rose  horseshoe  cherub's head  *too conc to id.* plain   
 other .....

**Grip bolts**

**Corner bolts**  **Type =** gilt brass  brass  iron   
 other ..... Sample Ret.

**Lid motifs**

other ..... Sample Ret.

**Escutcheons**

other ..... Sample Ret.

**Upholstery nails**

brass  gilt brass  silvered brass  iron  enamelled   
 other ..... Sample Ret.

**Fixings**

panel nails  screws  hinges  lace  Sample Ret.

**Timber type**

Sample Ret.

**Interpretation / Comments**

.....  
 .....

SITE		COFFIN RECORD SHEET		CONTEXT NO.	
OLROU				573	
Trench:		Additional sheets:		Treatment:	
Site sub-div: NC		Grave fills		BONE COLLECTED	
Plan no: 3		Grave cut:		Finds	
Section no:		Skeleton: 523		None	
Co-ordinates:		Matrix location: 523 524		Breastplate	
Levels		Preservation: GOOD		Grip	
Slide No.		Neg No:		Hinge	
Description		6-W ADULT PARTS MACHINED AWAY		Bracket	
Discussion				Fixing nails	
Shape, dimensions and distinguishing characteristics				Shroud pins	
LID				Fabric	
HEAD				Other finds	
BASE					
Recorder: JH		Date: 6/10/00		Initials:	



SITE	COFFIN RECORD SHEET		CONTEXT NO. 525
Trench: 04B-00	Additional sheets:		Treatment:
Site sub-div: NC	Grave fills		BONE COLLECTED
Plan no: 3	Grave cut:		Finds None
Section no:	Skeleton: 525		Breastplate Grip
Co-ordinates:	Matrix location: 524 525		Hinge Bracket
Levels	Preservation:		Fixing nails Shroud pins
Slide No.	Neg No:		Fabric Other finds
<p>Description 6-W Adult</p> <p>Discussion</p>			
<p>Shape, dimensions and distinguishing characteristics</p> <p>LID</p> <p>HEAD</p> <p>BASE</p>			
Recorder: J. H. W.	Date: 6/10/00		Initials:

SITE	COFFIN RECORD SHEET	CONTEXT NO.
OLR 00		526
Trench:	Additional sheets:	Treatment:
Site sub-div: NC	Grave fills	BONE COLLECTED
Plan no: 3	Grave cut:	Finds
Section no:	Skeleton: 526	None
Co-ordinates:	Matrix location: 521 526 527	Breastplate
Levels	Preservation: GOOD - FAIR	Grip
Slide No.	Neg No:	Hinge
Description	TRUNCATED LEGS OF SKELETON	ADULT E-W
Discussion	PROBABLY TRUNCATED BY 521	Bracket
Shape, dimensions and distinguishing characteristics		Fixing nails
LID		Shroud pins
HEAD		Fabric
BASE		Other finds
Recorder: JRW	Date: 8/10/00	Initials:

# Coffin Recording Sheet

**Outer Coffin**

Sample Ret.

Site Code

Context

Recording Date ..... *16/2/01* .....

*01200*

*526*

Associated Numbers .....

Condition .....

Dep. Plate

Legible

Inscription

Fabric lead  ormolou  brass  tin plated pewter  gilt tin   
 iron  silvered tin  enamelled  other ..... Sample Ret.

**Shape of dep. plate**

square  rectangle  shield  tapered  lozenge   
 cartouche  oval  other .....

**Upholstery**

colour ..... shoddy  velvet  other ..... Sample Ret.

**Construction**

butt joint  mitred  pitched  other .....

**Grip plate**

Fabric = ormolou  brass  tin plated pewter  gilt tin   
*Reason Rev. of Grip-wood*

iron  silvered tin  enamelled  other ..... Sample Ret.

**Grip**

Fabric = ormolou  brass  iron  *x2* Sample Ret.   
*(3b)*

**Design**

swag of rose  horseshoe  cherub's head  plain

other .....

**Grip bolts**

**Corner bolts**  Type = gilt brass  brass  iron

other ..... Sample Ret.

**Lid motifs**

other ..... Sample Ret.

**Escutcheons**

other ..... Sample Ret.

**Upholstery**

*studs*  
 nails  brass  gilt brass  silvered brass  iron  enamelled

other ..... *2 x pieces / 1 x 0000 / 1 x 00 = 6 studs* ..... Sample Ret.

**Fixings**

panel nails  screws  hinges  lace  Sample Ret.

**Timber type** .....

Sample Ret.

**Interpretation / Comments**

.....  
 .....

SITE GL100	COFFIN RECORD SHEET	CONTEXT NO. 527
Trench:	Additional sheets:	Treatment:
Site sub-div: NC	Grave fills	BONE COLLECTED
Plan no: 3	Grave cut:	Finds None
Section no:	Skeleton: 527	Breastplate Grip
Co-ordinates:	Matrix location: 526 527 564	Hinge Bracket
Levels	Preservation: GOOD	Fixing nails Shroud pins
Slide No.	Neg No:	Fabric Other finds
Description Adolescent GW TRUNCATED		
Discussion		
Shape, dimensions and distinguishing characteristics		
LID		
HEAD		
BASE		
Recorder: [Signature]	Date: 9/10/2001	Initials:

**Outer Coffin**

Sample Ret.

Site Code

Context

Recording Date ..... 16/02/01

02000

527

Associated Numbers .....

Condition .....

Dep. Plate

Legible

Inscription

Fabric lead  ormolou  brass  tin plated pewter  gilt tin   
iron  silvered tin  enamelled  other ..... Sample Ret.

**Shape of dep. plate**

square  rectangle  shield  tapered  lozenge   
cartouche  oval  other .....

**Upholstery**

colour ..... shoddy  velvet  other ..... Sample Ret.

**Construction**

butt joint  mitred  pitched  other .....

**Grip plate**

*Fabric = ormolou Reason ew of grip - unid*  
Fabric = ormolou  brass  tin plated pewter  gilt tin   
iron  silvered tin  enamelled  other ..... Sample Ret.

**Grip**

Fabric = ormolou  brass  iron  <sup>X1</sup> Sample Ret.

**Design**

swag of rose  horseshoe  cherub's head  <sup>(3b)</sup> plain

other .....

**Grip bolts**

Corner bolts  Type = gilt brass  brass  iron

other ..... Sample Ret.

**Lid motifs**

other ..... Sample Ret.

**Escutcheons**

other ..... Sample Ret.

**Upholstery nails**

brass  gilt brass  silvered brass  iron  enamelled

other ..... Sample Ret.

**Fixings**

panel nails  screws  hinges  lace  Sample Ret.

**Timber type** .....

Sample Ret.

**Interpretation / Comments**

.....  
.....



SITE	COFFIN RECORD SHEET	CONTEXT NO.
OLR 00		528
Trench:	Additional sheets:	Treatment: <i>Bones collected</i>
Site sub-div: <i>NC</i>	Grave fills <i>—</i>	
Plan no: <i>3</i>	Grave cut: <i>—</i>	Finds None
Section no:	Skeleton: <i>-528</i>	Breastplate Grip
Co-ordinates:	Matrix location: <i>528</i> <i>529</i> <i>530</i>	Hinge Bracket
Levels	Preservation: <i>GOOD.</i>	Fixing nails Shroud pins
Slide No.	Neg No:	Fabric Other finds
<p>Description <i>E-W <del>528</del> Juvenile/child burial. offies 529.</i></p> <p>Discussion</p> <p>Shape, dimensions and distinguishing characteristics</p> <p>LID</p> <p>HEAD</p> <p>BASE</p>		
Recorder: <i>D. Ham</i>	Date: <i>9.10.00.</i>	Initials:

SITE	COFFIN RECORD SHEET	CONTEXT NO.
OLR 00	Additional sheets:	529 Treatment: Bones collected
Trench:	Grave fills: —	
Site sub-div: NC	Grave cut: —	Finds
Plan no: 3	Skeleton: 529	None
Section no:	Matrix location: 529 530	Breastplate
Co-ordinates:	Preservation: good.	Grip
Levels	Slide No.	Hinge
Slide No.	Neg No:	Bracket
Description	Other finds	Fixing nails
Discussion	E-W Adult burial, offies 530, underlies 528.	
Shape, dimensions and distinguishing characteristics		
LID		
HEAD		
BASE		
Recorder: D. Hall	Date: 9.10.00	Initials:

# Coffin Recording Sheet

**Outer Coffin**

Sample Ret.

Site Code

Context

Recording Date ..... *21/2/01* .....

*04200*

*529*

Associated Numbers .....

Condition .....

Dep. Plate

Legible

Inscription

Fabric lead  ormolou  brass  tin plated pewter  gilt tin   
 iron  silvered tin  enamelled  other ..... Sample Ret.

**Shape of dep. plate**

square  rectangle  shield  tapered  lozenge   
 cartouche  oval  other .....

**Upholstery**

colour ..... shoddy  velvet  other *beize* ..... Sample Ret.

**Construction** butt joint  mitred  pitched  other .....

**Grip plate**  Fabric = ormolou  brass  tin plated pewter  gilt tin   
 iron  silvered tin  enamelled  other ..... Sample Ret.

**Grip**  Fabric = ormolou  brass  iron  Sample Ret.

**Design** swag of rose  horseshoe  cherub's head  plain   
 other .....

**Grip bolts**  **Corner bolts**  **Type =** gilt brass  brass  iron   
 other ..... Sample Ret.

**Lid motifs**  other ..... Sample Ret.

**Escutcheons**  other ..... Sample Ret.

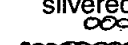
**Upholstery** <sup>studs</sup> ~~nails~~  brass  gilt brass  silvered brass  iron  enamelled   
 other *4 pins 1x000/1x0000/1x 88/1x  = 33 studs* ..... Sample Ret.

**Fixings**  panel nails  screws  hinges  lace  Sample Ret.

**Timber type** ..... Sample Ret.

**Interpretation / Comments**

.....  
 .....

SITE <i>OLR 00</i>		COFFIN RECORD SHEET	CONTEXT NO. <i>530</i>
Trench:	Additional sheets:	Treatment: <i>Bones collected</i>	
Site sub-div: <i>NC</i>	Grave fills: <i>-</i>		
Plan no: <i>3</i>	Grave cut: <i>-</i>	Finds None	
Section no:	Skeleton: <i>530</i>	Breastplate Grip	
Co-ordinates:	Matrix location: <i>528</i> <i>529</i> <i>530</i>	Hinge Bracket	
Levels	Preservation: <i>Good.</i>	Fixing nails Shroud pins	
Slide No.	Neg No:	Fabric Other finds	
Description <i>E-W Adult burial, underlying 529.</i>			
Discussion			
Shape, dimensions and distinguishing characteristics			
LID			
HEAD			
BASE			
Recorder: <i>D. Ham</i>	Date: <i>9.10.00</i>	Initials:	

Outer Coffin

Sample Ret.

Site Code

Context

Recording Date ..... *2/2/01* .....

*OH200*

*530*

Associated Numbers .....

Condition .....

Dep. Plate

Legible

Inscription

Fabric lead  ormolou  brass  tin plated pewter  gilt tin   
iron  silvered tin  enamelled  other ..... Sample Ret.

Shape of dep. plate

square  rectangle  shield  tapered  lozenge   
cartouche  oval  other .....

Upholstery

colour ..... shoddy  velvet  other *baize* ..... Sample Ret.

Construction butt joint  mitred  pitched  other .....

Grip plate  Fabric = ormolou  brass  tin plated pewter  gilt tin   
iron  *frags on lev on grip - unid* silvered tin  enamelled  other ..... Sample Ret.

Grip  Fabric = ormolou  brass  iron  *x 1 too conc. to id.* Sample Ret.



Design swag of rose  horseshoe  cherub's head  plain   
other .....

Grip bolts  Corner bolts  Type = gilt brass  brass  iron

other ..... Sample Ret.

Lid motifs  other ..... Sample Ret.

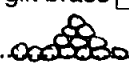
Escutcheons  other ..... Sample Ret.

Upholstery *studs*  brass  gilt brass  silvered brass  iron  enamelled   
other *5 x pieces / 3 x 000 / 1 x  / 1 x  = 35 studs* ..... Sample Ret.

Fixings  panel nails  screws  hinges  lace  Sample Ret.

Timber type ..... Sample Ret.

Interpretation / Comments

.....  
.....

db

SITE 02200	COFFIN RECORD SHEET	CONTEXT NO. 531
Trench:	Additional sheets:	Treatment: INTACT.
Site sub-div: CRUPT Bay 3	Grave fills	
Plan no: 7	Grave cut:	Findings None Breastplate - 1 pb soldered Grip - 2 plates - 1 in ③ X2 - 1 in ④
Section no:	Skeleton:	Hinge
Co-ordinates:	Matrix location: Bay 3	Bracket
Levels:	Preservation: INTACT.	Fixing nails
Slide No.	Neg No:	Shroud pins
		Fabric
		Other finds

Description: INTACT LEAD Coffin.

Discussion:

Shape, dimensions and distinguishing characteristics

LID

Mrs Sarah Wilson  
Died 29<sup>th</sup> Oct 1814  
In her 77<sup>th</sup> Year

HEAD

BASE

0.227 Soldered  
① rect.

0.25

0.51

1.82

0.23

DEPTH: 0.36

Recorder: Am	Date: 6.10.00	Initials:
--------------	---------------	-----------

db

SITE	COFFIN RECORD SHEET	CONTEXT NO.
0LR00		532
Trench:	Additional sheets:	Treatment:
Site sub-div: CAMP BAN 3.	Grave fills:	DVA/BOULS.
Plan no: 7	Grave cut:	Finds
Section no:	Skeleton:	None + inscription pb ② Breastplate X 2 - ⑤ pb □ Grip X ⑥ pb ▽
Co-ordinates:	Matrix location: Boy 3	Hinge
Levels	Preservation: <u>underside of the coffin</u> Corroded.	Bracket
Slide No.	Neg No:	Fixing nails
		Shroud pins
		Fabric
		Other finds

**Description** Quite Squashed at head (West) End - Corroded on Base.  
Outer Breast Plate (Pb)  
Inner Plate - engraved on Coffin - Oak(?) Leaf Border.

**Discussion**

(remains of shroud) Inner inscription → Mr John Markham  
Died 2nd October 1828  
Aged 77 Years

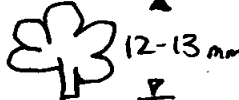

**Shape, dimensions and distinguishing characteristics**

**LID** ①

"Me  
John Markham  
1828"

**HEAD**

plain border  
w/ flourishes  
under legend

**BASE**

②

MK  
John Markham  
Died 2 October  
1828  
Aged 77 years"

black polished

spds ② w/  
diff. bordered  
(top).

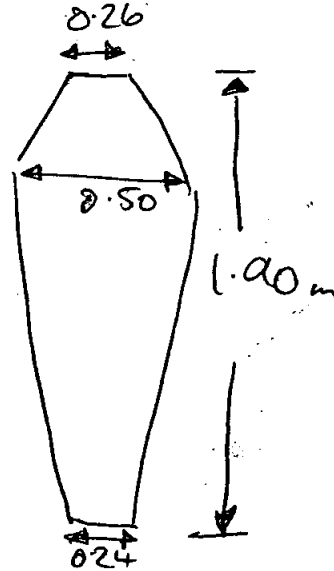

DEPTH: 0.34

Recorder: TM	Date: 6.10.00	Initials:
--------------	---------------	-----------

AP

SITE <i>02100</i>	COFFIN RECORD SHEET	CONTEXT NO. <i>533</i>
Trench:	Additional sheets:	Treatment: <i>INTACT</i>
Site sub-div: <i>CRUT BAY 3.</i>	Grave fills	
Plan no: <i>7</i>	Grave cut:	Finds None ✓ <i>inscription</i>
Section no:	Skeleton:	Breastplate <i>Grip x 1 sptfols ①</i>
Co-ordinates:	Matrix location: <i>Bay 3</i>	Hinge
Levels	Preservation: <i>wood.</i>	Bracket
Slide No.	Neg No:	Fixing nails
		Shroud pins
		Fabric
		Other finds

Description *Pb Coffin - Good STATE. ENGRAVED LID:-*

Discussion *MR Tho Wilson  
Died 15 March 1792  
Aged 61 49 (61?)*

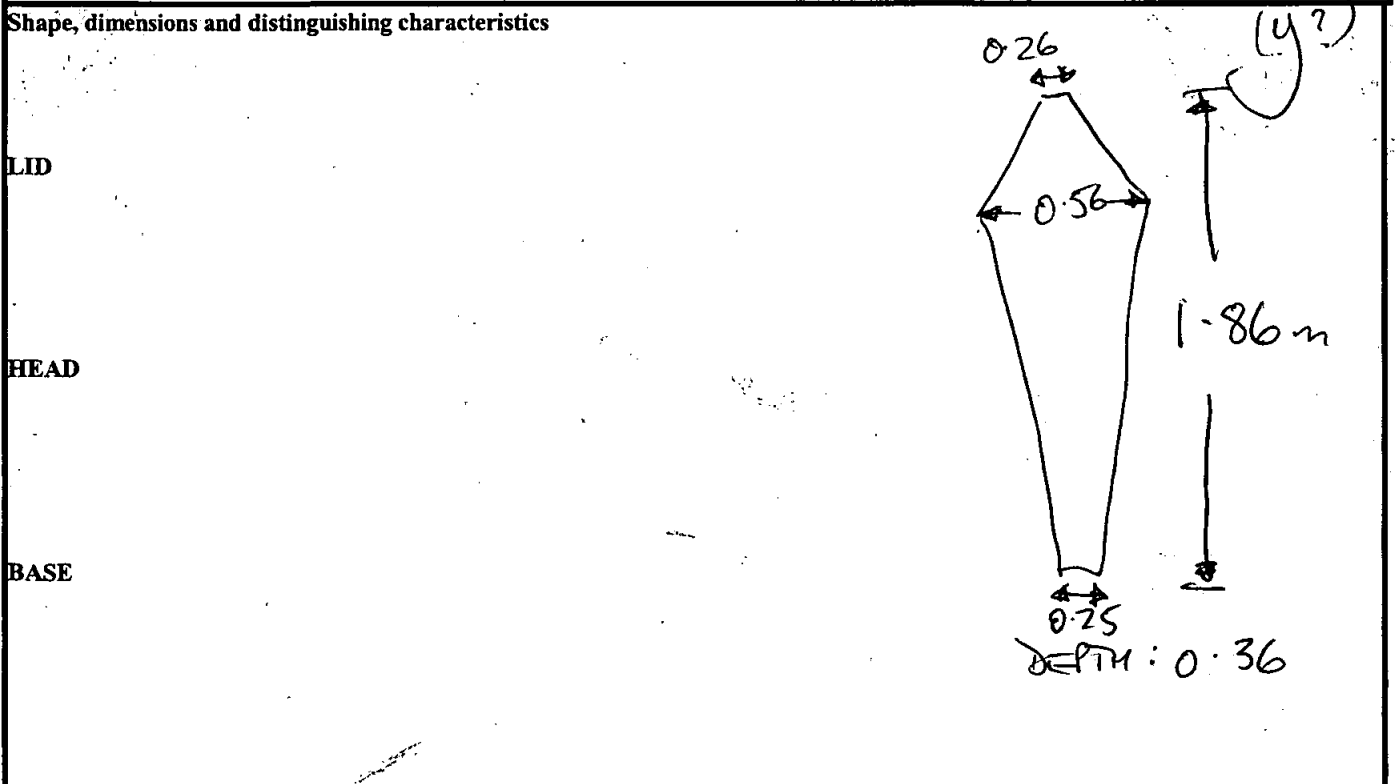

Recorder: <i>M</i>	Date: <i>6.10.00</i>	Initials:
--------------------	----------------------	-----------



db

SITE OLR00	COFFIN RECORD SHEET	CONTEXT NO. 534.
Trench:	Additional sheets:	Treatment: INTACT
Site sub-div: CAMPT Bay 3.	Grave fills	Finds None inscriptions (2) Breastplate ✓ x 1 pb (1) Grip x 1 spltds (4) w/ fractured fingers tin.
Plan no: 7	Grave cut:	
Section no:	Skeleton:	Hinge
Co-ordinates:	Matrix location: w/ 356 Bay 3	Bracket
Levels	Preservation:	Fixing nails
Slide No.	Neg No:	Shroud pins
		Fabric ✓ velvet on red grip
		Other finds

Description Pb Coffin - Outer Breast Plate. (2) a Mr  
 Discussion Joe Deer  
 Died 26<sup>th</sup> June  
 1831  
 Aged 64 Years

Shape, dimensions and distinguishing characteristics (2)  
 inscription (2)  
 Engraved Coffin Lid: - spltds (2) (top) w/ diff outer border.

MR  
 Joseph Deer  
 Died 26<sup>th</sup> June  
 1831  
 Aged 64 Yrs

0.35  
0.6  
1.86m  
0.28  
0.37

Recorder: <i>DM</i>	Date: 6.10.00	Initials:
---------------------	---------------	-----------

db

SITE OLR00	COFFIN RECORD SHEET	CONTEXT NO. 535
Trench: 5C	Additional sheets:	Treatment: SKELETON LIFTED
Site subdiv:	Grave fills	
Plan no: 6	Grave cut:	Finds None
Section no:	Skeleton:	Breastplate Grip x 1 Fe (4)
Co-ordinates:	Matrix location: in vault 496	Hinge Bracket
Levels	Preservation:	Fixing nails Shroud pins
Slide No.	Neg. No.:	Fabric Other finds

Description: wood coffin. v. badly damaged. traces of Fe up sides - only head end extant, total collapse from shoulders down.

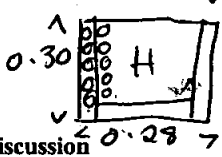
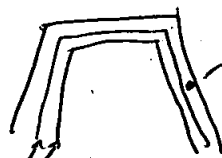
Discussion:   Fe square lid bolt

db row Fe.

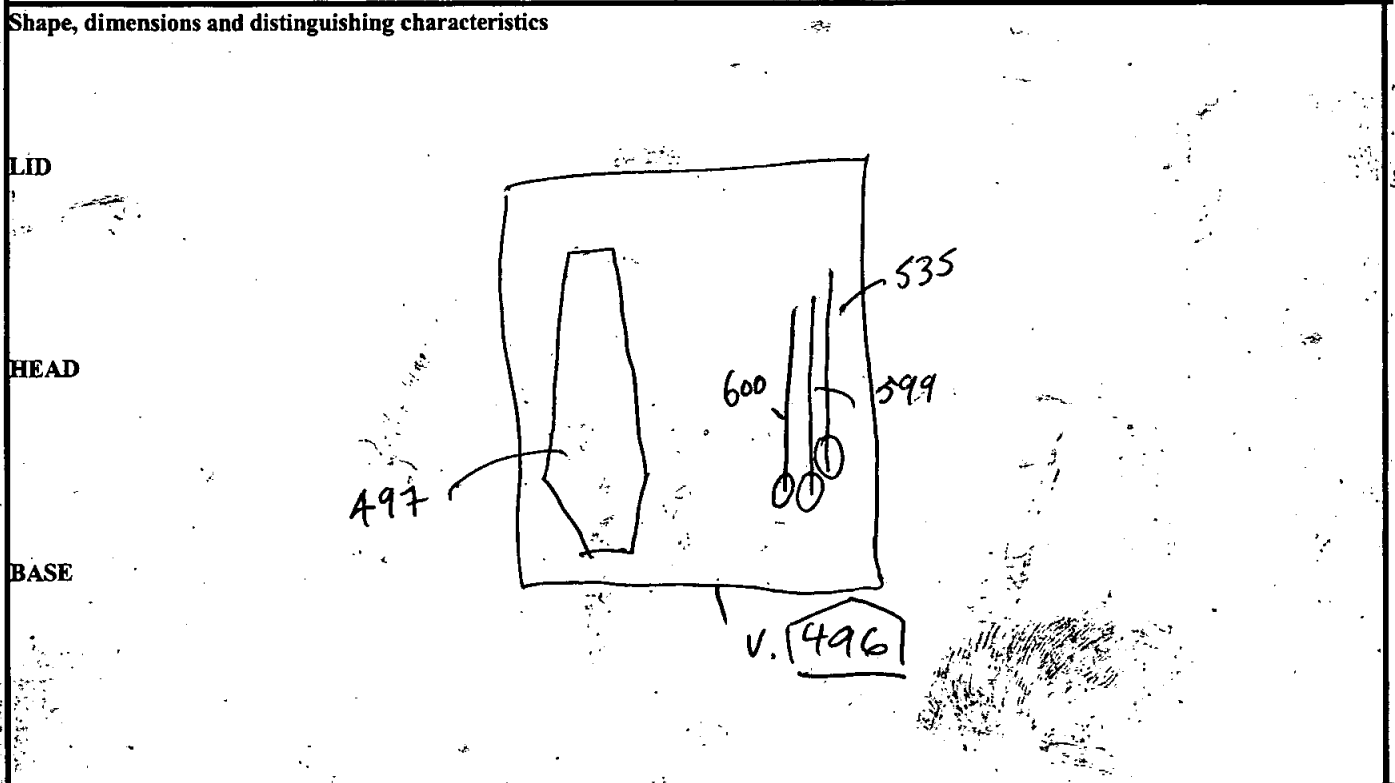

Recorder: S.M	Date:	Initials:
------------------	-------	-----------

db

SITE <i>01200</i>	COFFIN RECORD SHEET	CONTEXT NO: <i>536</i>
Trench:	Additional sheets: <i>YES X 1</i>	Treatment: <i>INTACT</i>
Site sub-div: <i>CMPT.</i>	Grave fills	
Plan no: <i>7.</i>	Grave cut:	Finds None + inscription (3)
Section no:	Skeleton:	Breastplate (6) Grip x 2. sptfdo (4)
Co-ordinates:	Matrix location: <i>in Bay A</i>	Hinge Bracket
Levels	Preservation: <i>Intact.</i> <i>4</i>	Fixing nails Shroud pins
Slide No.	Neg No:	Fabric Other finds

Description *to Infant Coffin.*  
*Breastplate :-*

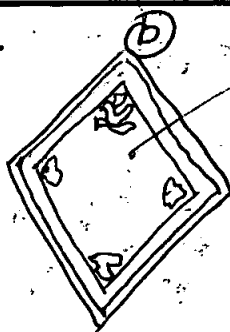

*Miss Eliza Smith  
Died 10th May  
1822  
Aged 3 Years  
5 Mon: 13 Weeks*

Discussion

Shape, dimensions and distinguishing characteristics

*SOLDERED PLATE ON to Coffin :-*

LID

HEAD

BASE

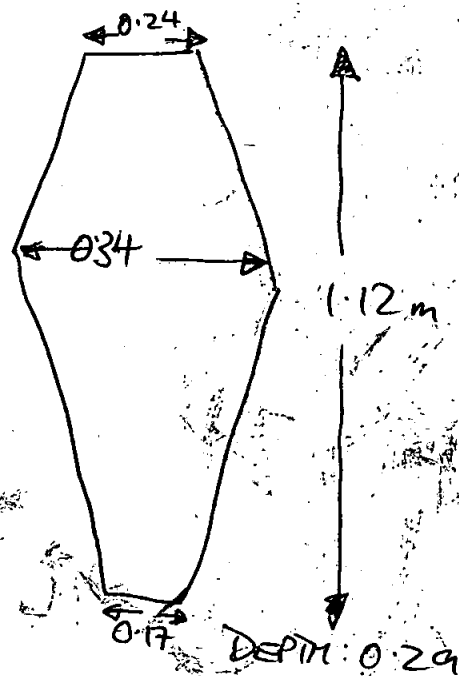
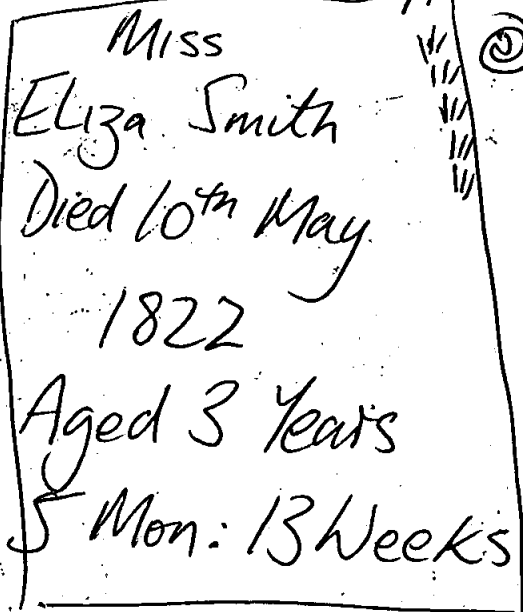

Recorder: *M*

Date: *9.10.00*

Initials:

db

SITE 02200	COFFIN RECORD SHEET	CONTEXT NO. 537
Trench: GRMPT	Additional sheets:	Treatment: SKELETON LIFTED & DNA TAKEN
Site sub-div:	Grave fills	Finds FOOTPLATE
Plan no: 7	Grave cut:	None
Section no:	Skeleton:	Breastplate <del>✓</del> Outer + Inner
Co-ordinates:	Matrix location: In Bay 4	Grip X1 spfelo ①
Levels	Preservation: Corroded at base 1	Hinge
Slide No.	Neg No:	Bracket
		Fixing nails
		Shroud pins
		Fabric
		Other finds

Description ①  
 ① Coffin. ReNailed foot Plate (P6)

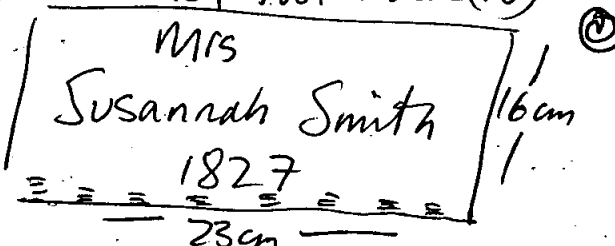
Discussion  

Shape, dimensions and distinguishing characteristics  
 ① Breast Plate - Soldered to Coffin: -

LID  
 HEAD  
 BASE

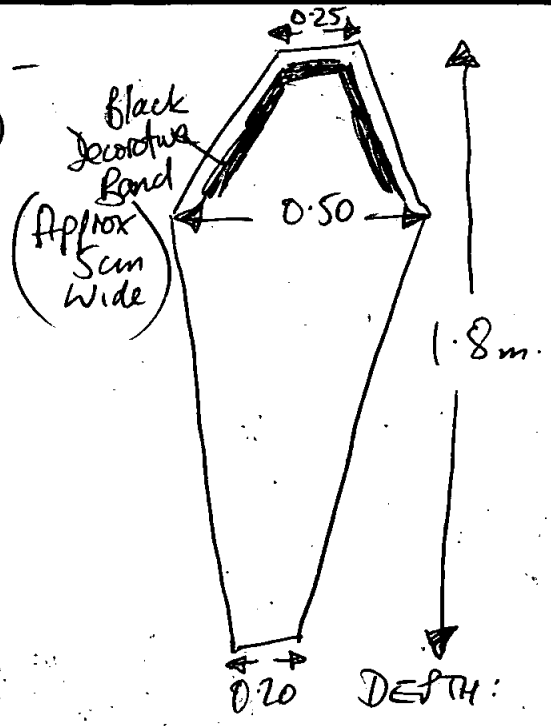
①  

Mrs  
 Susannah Smith  
 Died 8th May  
 1827  
 Aged 39 Years

① = spfcls ⑧

Recorder: Jm Date: 9.10.00: Initials:

nb

SITE OLB00	COFFIN RECORD SHEET	CONTEXT NO. 538
Trench:	Additional sheets: YES x 1	Treatment: DNA + BONES.
Site sub-div: CRYPT. B114	Grave fills	
Plan no: 7	Grave cut:	Finds None
Section no:	Skeleton:	Breastplate x 2 OUTER + INNER Grip
Co-ordinates:	Matrix location:	Hinge Bracket
Levels	Preservation: <u>broken</u> 1	Fixing nails Shroud pins
Slide No.	Neg No:	Fabric Other finds

Description Pb Coffin - Black 5cm bending similar to (537)  
Pb Inner Breast Plate - soldered at corners.

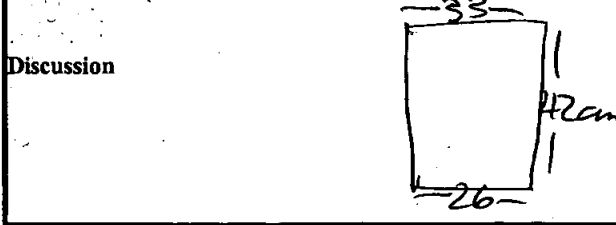

Mr  
Thos<sup>s</sup> Giles  
Died 31<sup>st</sup> Jan  
1844  
Aged 20 Yrs.

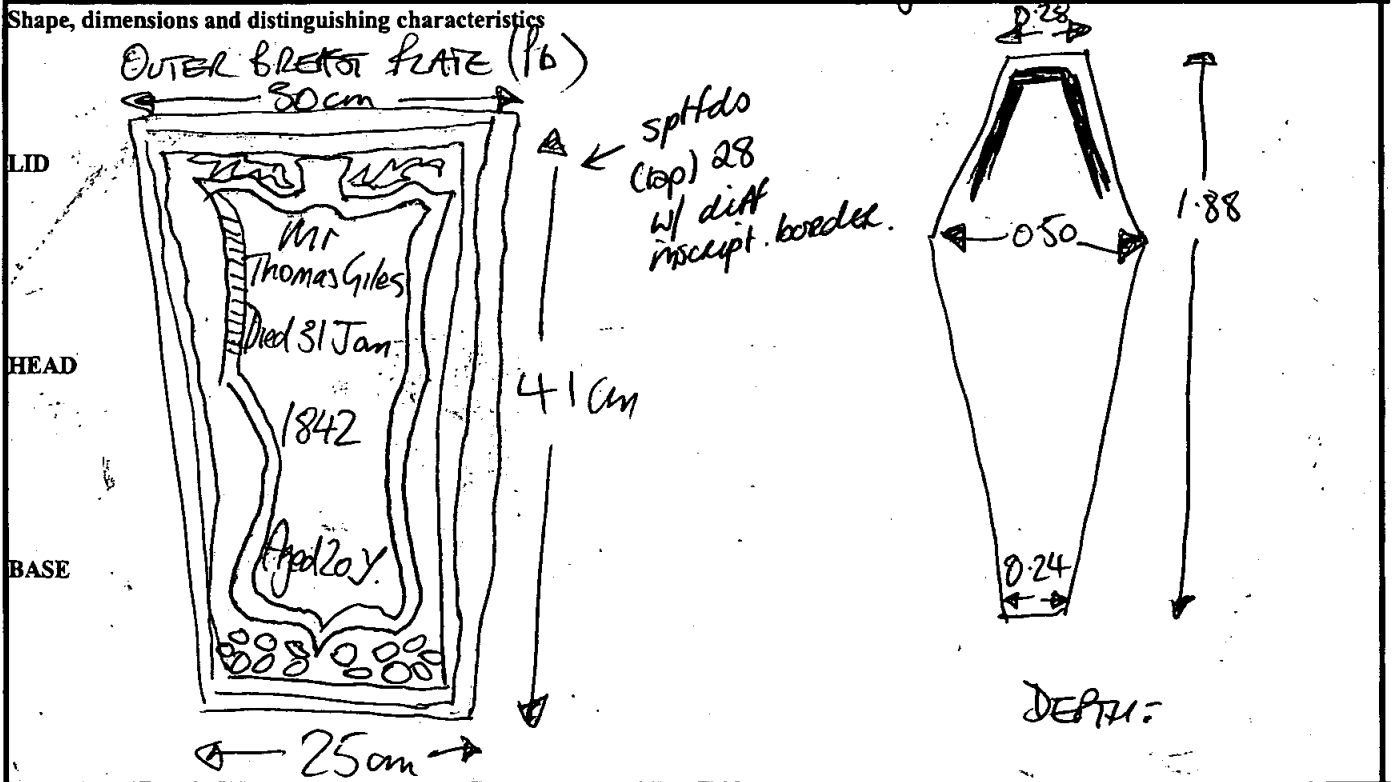

Recorder: *Th* Date: 1.10.00 Initials:

Sptfds (top) (28) except w/  
different inscription border & shield.

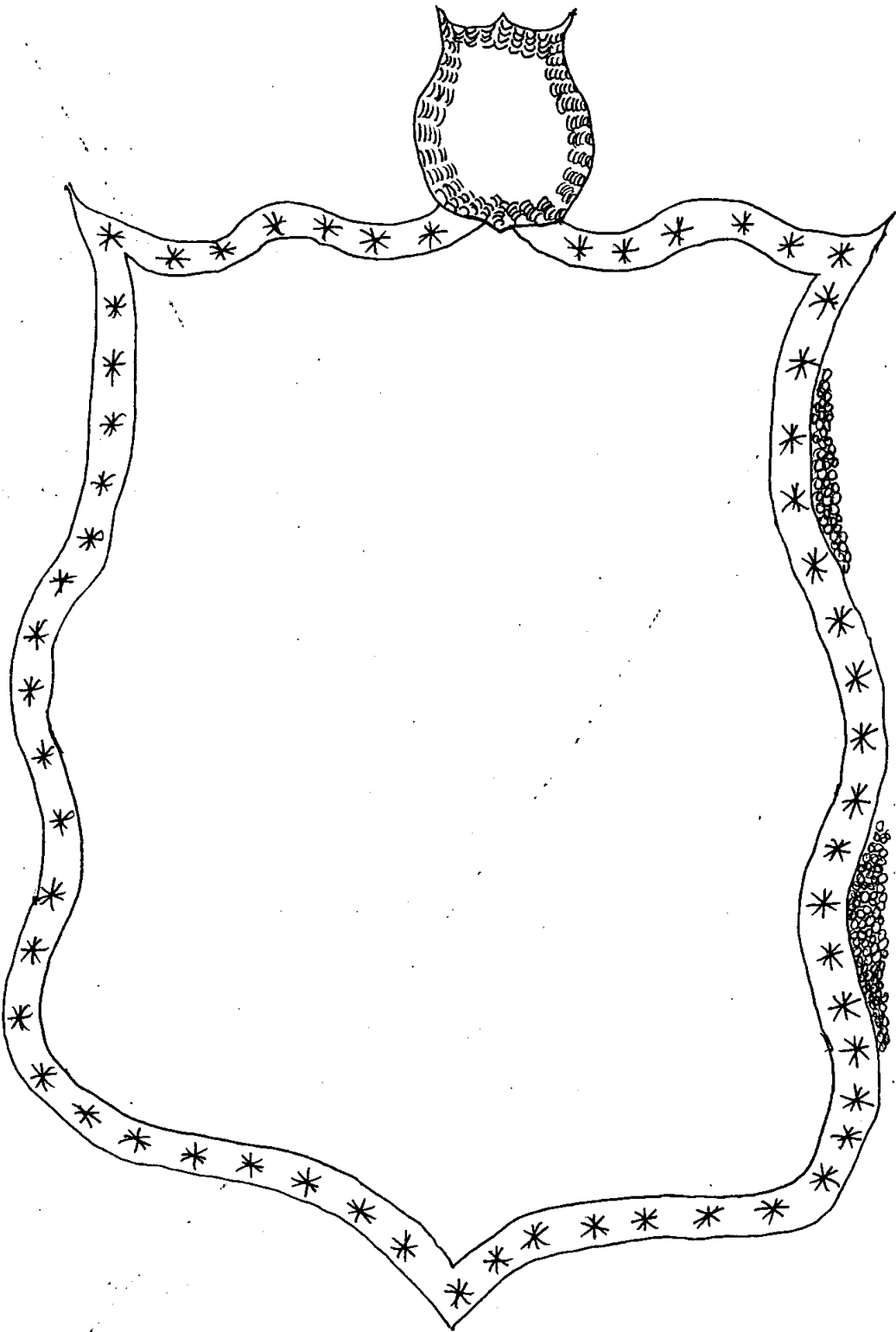

w/ no outer border.

dlb

SITE OLR00	COFFIN RECORD SHEET	CONTEXT NO. 539
Trench: CCMPT	Additional sheets:	Treatment: BONES + DNA (TOES + TEETH) 1 CANINE - NO MARK IN ALL
Site sub-div:	Grave fills	
Plan no: 7	Grave cut:	Finds None
Section no:	Skeleton:	Breastplate x 2 Grip
Co-ordinates:	Matrix location: in box A	Hinge Bracket
Levels	Preservation: broken/corroded/squashed. 1	Fixing nails Shroud pins
Slide No.	Neg No:	Fabric Other finds

Description: lb Coffin. Inscribed: - Mr James Jones. Died 27 July 1839 Aged 70 Y sptfds (21)

Outer Breast Plate

Shape, dimensions and distinguishing characteristics

ul diff outer border some ∞ (534)

LID

HEAD

BASE

Recorder: M. Date: 9.10.00 Initials:

db

SITE <i>0CR00.</i>	COFFIN RECORD SHEET	CONTEXT NO. <i>340</i>
Trench: <i>CRYPT</i>	Additional sheets:	Treatment: <i>SKELETON LIFTED</i>
Site sub-div:	Grave fills	- <i>DNA TAKEN</i>
Plan no: <i>7</i>	Grave cut:	Finds None <i>inscript.</i>
Section no:	Skeleton:	<del>Breastplate</del> Grip
Co-ordinates:	Matrix location: <i>in box 4</i>	Hinge Bracket
Levels	Preservation: <i>2</i>	Fixing nails Shroud pins
Slide No.	Neg No:	Fabric Other finds

Description *infant p.p. coffin*

Discussion

Shape, dimensions and distinguishing characteristics

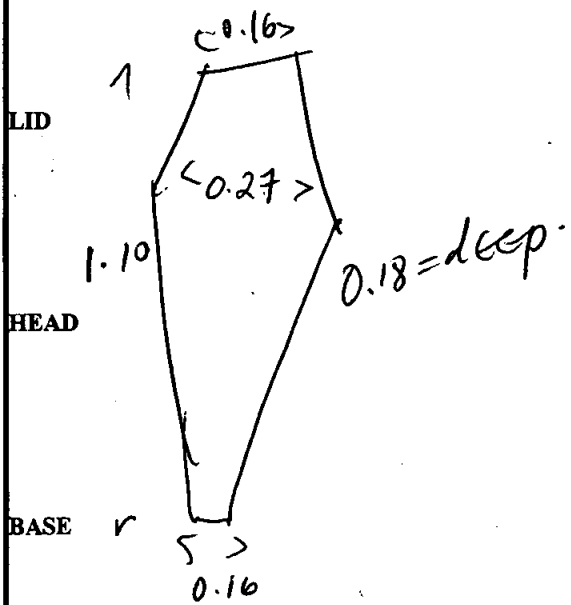

*"Miss  
Eliz<sup>m</sup> Giles  
Died 17<sup>th</sup> May  
∴ 1827∴  
Aged 5 years  
& 5 months"*

Recorder:	Date: <i>9/10</i>	Initials: <i>MRC.</i>
-----------	-------------------	-----------------------



dap

SITE DLR00	COFFIN RECORD SHEET	CONTEXT NO. 541
Trench: CRMP1	Additional sheets:	Treatment: SKELTON LIFTED & DNA LIFTED
Site sub-div:	Grave fills	
Plan no: 7	Grave cut:	Finds None inscription (b) dep plate x 1 (c)
Section no:	Skeleton:	Breastplate Grip
Co-ordinates:	Matrix location: in Bay A	Hinge Bracket
Levels	Preservation: 2	Fixing nails Shroud pins
Slide No.	Neg No:	Fabric Other finds

Description *sub adult p.b. coffin*

Discussion

Shape, dimensions and distinguishing characteristics

LID  
HEAD  
BASE

①  
"Master  
John Giles  
Died 2<sup>nd</sup> July  
1826  
Aged 7 Yrs & 3 Mm<sup>s</sup>"

②  
"John Giles  
July 1826"

Recorder: \_\_\_\_\_ Date: \_\_\_\_\_ Initials: \_\_\_\_\_

db

SITE OLLOO	COFFIN RECORD SHEET	CONTEXT NO. S42
Trench: CRYPT	Additional sheets:	Treatment: SKELETON LIFTED & DNA TAKEN
Site sub-div:	Grave fills	
Plan no: 7	Grave cut:	Finds None inscription Coxidised
Section no:	Skeleton:	Breastplate Grip
Co-ordinates:	Matrix location: in Bay 4	Hinge Bracket
Levels	Preservation: 2	Fixing nails Shroud pins
Slide No.	Neg No:	Fabric Other finds

Description  
adult p.b. coffin

Discussion

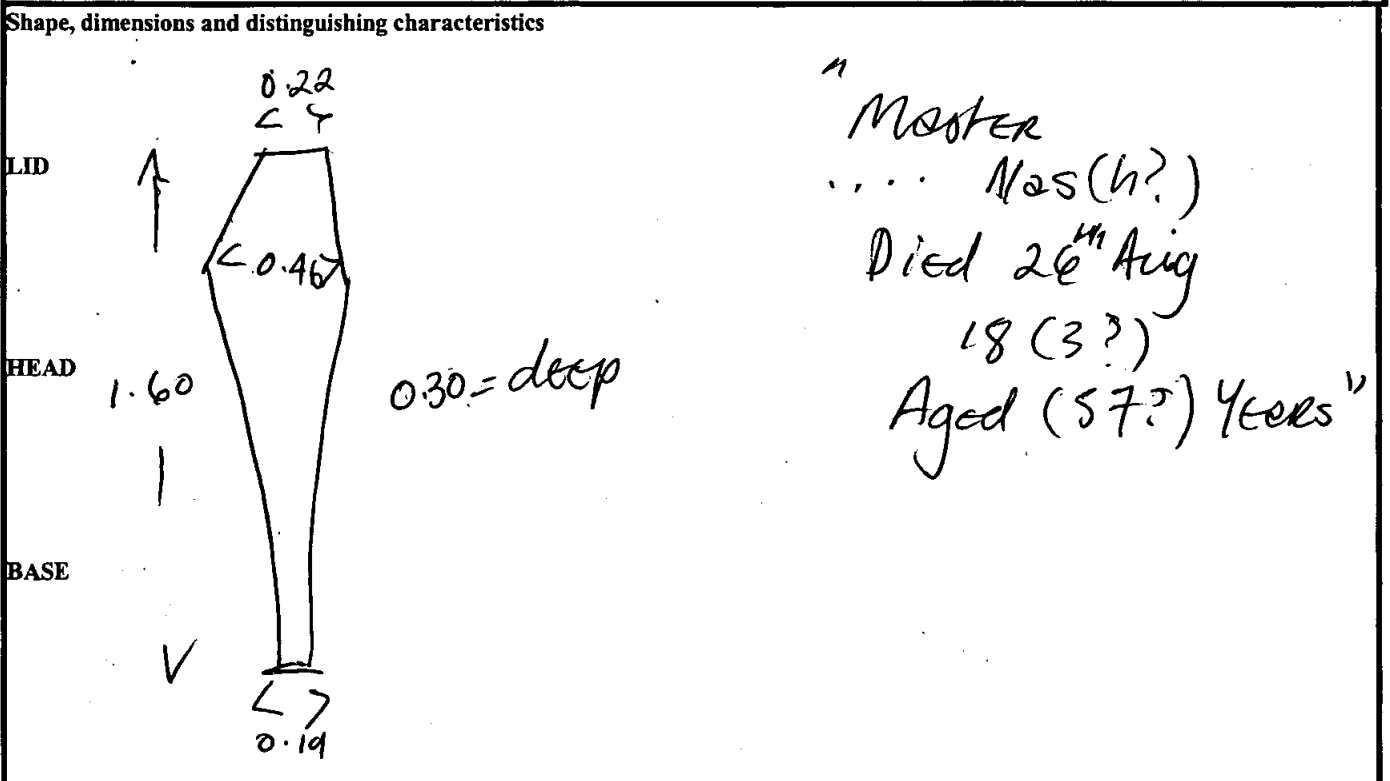

Recorder:                      Date: 9/80                      Initials: MR

da

SITE <b>OLKOO</b>	COFFIN RECORD SHEET	CONTEXT NO. <b>S43</b>
Trench: <b>CRYPT</b>	Additional sheets:	Treatment: <b>TEETH TAKEN</b>
Site sub-div:	Grave fills	<b>- NO BONES -</b>
Plan no: <b>7</b>	Grave cut:	Finds
Section no:	Skeleton:	None
Co-ordinates:	Matrix location: <b>in Bay 4</b>	inscription <b>Ⓢ</b>
Levels	Preservation:	Breastplate: <b>deep plates <sup>Ⓢ</sup></b>
Slide No.	Neg No:	Grip <b>(1) (2) (3) (4) (5) (6) (7) (8) (9) (10) (11) (12) (13) (14) (15) (16) (17) (18) (19) (20) (21) (22) (23) (24) (25) (26) (27) (28) (29) (30) (31) (32) (33) (34) (35) (36) (37) (38) (39) (40) (41) (42) (43) (44) (45) (46) (47) (48) (49) (50) (51) (52) (53) (54) (55) (56) (57) (58) (59) (60) (61) (62) (63) (64) (65) (66) (67) (68) (69) (70) (71) (72) (73) (74) (75) (76) (77) (78) (79) (80) (81) (82) (83) (84) (85) (86) (87) (88) (89) (90) (91) (92) (93) (94) (95) (96) (97) (98) (99) (100)</b>
		Hinge
		Bracket
		Fixing nails
		Shroud pins
		Fabric
		Other finds

Description **6 x KERT cuts.**

skelly still articulated - bones not lifted -  
teeth: taken - some soft tissue survival.

Discussion

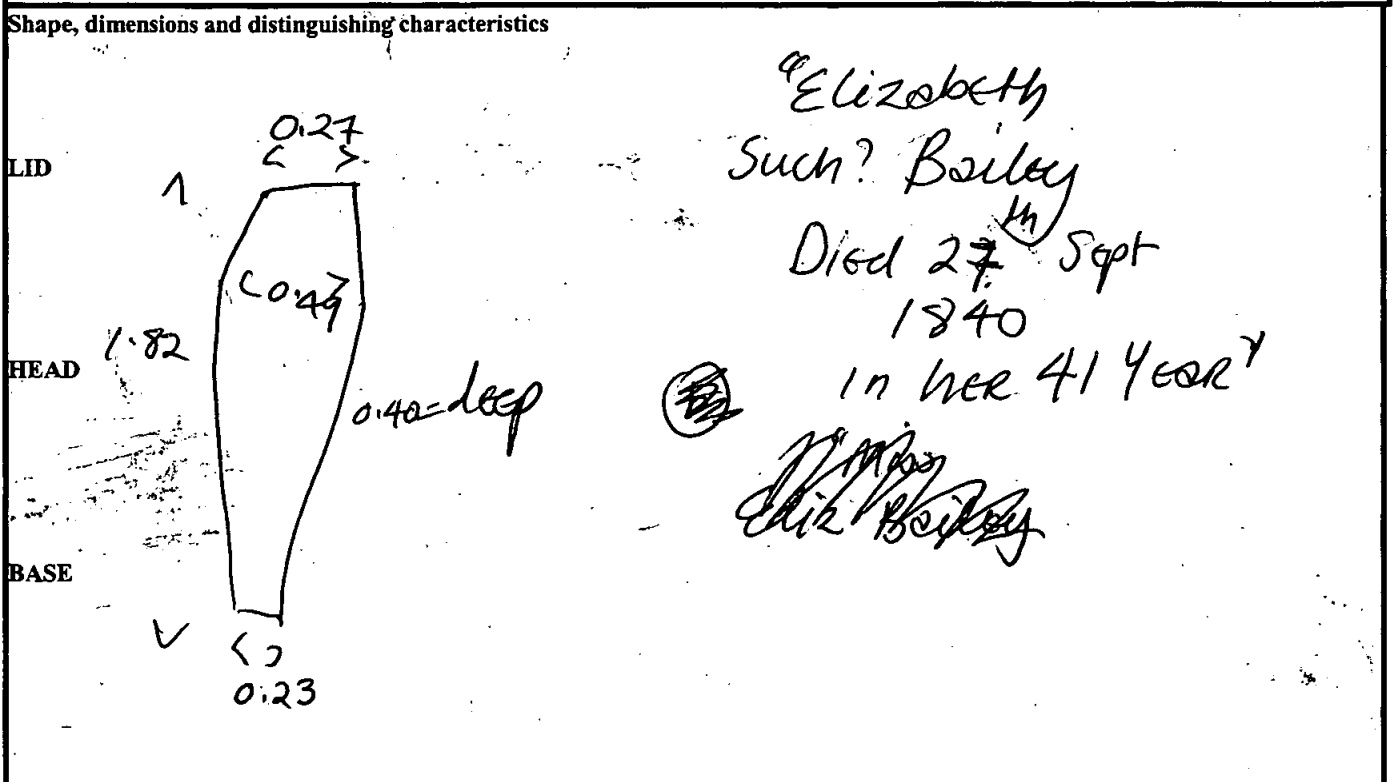

Recorder:	Date:	Initials:
-----------	-------	-----------

Oxford Archaeological Unit

SITE		CONTEXT RECORD		Context No. <b>544</b>
<b>OLR00</b>		Additional Sheets:		Type <b>STRUCTURE</b>
Trench	Context Type: Deposit / Cut / <b>(Structure)</b>		Check Lists:	
Site sub-div <b>N.C.</b>	Overlain by:		DEPOSIT:	
Structure No.	Abutted by:		1.compaction 2.colour 3.composition 4.inclusions 5.thickness 6.extent 7.comments 8.method 8.conditions	
Plan No. <b>3.</b>	Cut by:		CUT:	
	Filled by:		1.shape in plan 2.base/sides/top profile 3.dimension and depth 4.sketch 5.truncation 6.fill nos 7.other comments	
Section No.	Same as:		MASONRY:	
	Part of:		1.materials 2.size of bricks etc 3.finish of stones 4.coursing/bond 5.form 6.faces 7.bond 8.dimensions as found 9.other comments	
Co-Ordinates	Consists of:			
	Overlies:			
Level	Butts:			
Slide No.	Cuts:			
Neg No.	Fill of:			
Matrix location	Relationships uncertain			
Description (See check lists):			STRATIGRAPHIC MATRIX	
<b>Brick support for ledger stone or monument, 1.80 x 0.80 m max dimension</b>				
<b>0.23 m wide, 2 courses deep.</b>				
<b>Mortared bricks.</b>				
<b>C. 0.30 m below modern ground surface.</b>				
Interpretation/Discussion:				
<b>Brick support for ledger stone.</b>				
Finds (tick): None <input type="checkbox"/> Pot <input type="checkbox"/> Bone <input type="checkbox"/> Flint <input type="checkbox"/> Stone <input type="checkbox"/> Burnt stone <input type="checkbox"/> Glass <input type="checkbox"/> Metal <input type="checkbox"/>				
CBM <input type="checkbox"/> Wood <input type="checkbox"/> Leather <input type="checkbox"/>				
△Small Finds			Recorder <b>DS</b>	
◇Samples			Date <b>9/10</b>	
△Building Materials			Initials	



SITE <b>OLR00</b>		CONTEXT RECORD		Context No. <b>545</b>
Trench		Additional Sheets:		Type <b>STRUCTURE</b>
Site sub-div <b>N.C.</b>		Context Type: Deposit / Cut <b>Structure</b>		Check Lists:
Structure No.		Overlain by:		DEPOSIT: 1.compaction 2.colour 3.composition 4.inclusions 5.thickness 6.extent 7.comments 8.method & conditions
Plan No. <b>3</b>		Abuted by:		
Section No.		Cut by:		CUT: 1.shape in plan 2.base/sides/top profile 3.dimension and depth 4.sketch 5.truncation 6.fill nos 7.other comments
Co-Ordinates		Filled by:		
Level		Same as:		MASONRY: 1.materials 2.size of bricks etc 3.finish of stones 4.coursing/bond 5.form 6.faces 7.bond 8.dimensions as found 9.other comments
Slide No.		Part of:		
Neg No.		Consists of:		
Matrix location		Overlies:		
Description (See check lists):		Butts:		
<p><b>3 Stone Slabs 0.90 x 0.75 x 0.08m thick, supported by brick surround base, 5 courses thick. (bricks mortared)</b></p>		Cuts:		
		Fill of:		
		Relationships uncertain		
		<p>STRATIGRAPHIC MATRIX</p>		
<p><b>C. 0.30m below modern ground surface.</b></p>				
<p>Interpretation/Discussion:</p> <p><b>Slabs &amp; brick support for monument or ledger stone</b></p>				
<p>Finds (tick): None <input type="checkbox"/> Pot <input type="checkbox"/> Bone <input type="checkbox"/> Flint <input type="checkbox"/> Stone <input type="checkbox"/> Burnt stone <input type="checkbox"/> Glass <input type="checkbox"/> Metal <input type="checkbox"/> CBM <input type="checkbox"/> Wood <input type="checkbox"/> Leather <input type="checkbox"/></p>				
<p>Δ Small Finds</p>			Recorder <b>DS</b>	
<p>◇ Samples</p>			Date <b>9/10</b>	
<p>△ Building Materials</p>			Initials	

SITE <i>OL200</i>	CONTEXT RECORD	Context No. <i>546</i>
	Additional Sheets:	Type <i>STRUCTURE</i>
Trench	Context Type: Deposit / Cut / <u>Structure</u>	Check Lists:
Site sub-div <i>N.C.</i>	Overlain by:	DEPOSIT: 1.compaction 2.colour 3.composition 4.inclusions 5.thickness 6.extent 7.comments 8.method & conditions
Structure No.	Abutted by:	
Plan No.  <i>3</i>	Cut by:  Filled by:	CUT: 1.shape in plan 2.base/sides/top profile 3.dimension and depth 4.sketch 5.truncation 6.fill nos 7.other comments
Section No.	Same as:  Part of:	
Co-Ordinates	Consists of:  Overlies:	MASONRY: 1.materials 2.size of bricks etc 3.finish of stones 4.coursing/bond 5.form 6.faces 7.bond 8.dimensions as found 9.other comments
Level	Butts:	
Slide No.	Cuts:	
Neg No.	Fill of:	
Matrix location	Relationships uncertain	
Description (See check lists): <i>Brick base for ledger stone or monument. 2x1m - 5 courses.</i>  <i>C. 0.30 m below modern ground surface</i>		
STRATIGRAPHIC MATRIX		
Interpretation/Discussion: <i>Brick base for ledger or monument</i>		
Finds (tick): None <input type="checkbox"/> Pot <input type="checkbox"/> Bone <input type="checkbox"/> Flint <input type="checkbox"/> Stone <input type="checkbox"/> Burnt stone <input type="checkbox"/> Glass <input type="checkbox"/> Metal <input type="checkbox"/> CBM <input type="checkbox"/> Wood <input type="checkbox"/> Leather <input type="checkbox"/>		
ΔSmall Finds	Recorder <i>DS</i>	
◇Samples	Date <i>9/10</i>	
ΔBuilding Materials	Initials	

Oxford Archaeological Unit

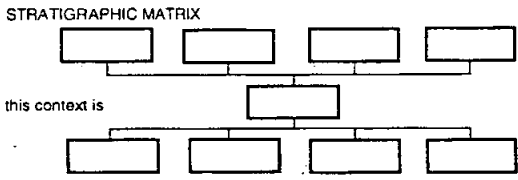
SITE <i>OLR00</i>		CONTEXT RECORD		Context No. <i>547</i>
Trench		Additional Sheets:		Type <i>STRUCTURE</i>
Site sub-div <i>N.C.</i>	Context Type: Deposit / Cut / <u>Structure</u>	Check Lists:		
Structure No.	Overlain by:	DEPOSIT:		
Plan No. <i>3</i>	Abutted by:	1.compaction 2.colour 3.composition 4.inclusions 5.thickness 6.extent 7.comments 8.method & conditions		
Section No.	Cut by:	CUT:		
Co-Ordinates	Filled by:	1.shape in plan 2.base/sides/top profile 3.dimension and depth 4.sketch 5.truncation 6.fill nos 7.other comments		
Level	Same as:	MASONRY:		
Slide No.	Part of:	1.materials 2.size of bricks etc 3.finish of stones 4.coursing/bond 5.form 6.faces 7.bond 8.dimensions as found 9.other comments		
Neg No.	Consists of:			
Matrix location	Overlies:			
	Butts:			
	Cuts:			
	Fill of:			
	Relationships uncertain			
Description (See check lists): <i>Brick base - 4 courses thick.</i> <i>1.65 x 0.80 m</i> <i>C. 0.30 m below modern ground surface</i>		STRATIGRAPHIC MATRIX 		
Interpretation/Discussion: <i>Brick support for ledger or monument</i>				
Finds (tick): None <input type="checkbox"/> Pot <input type="checkbox"/> Bone <input type="checkbox"/> Flint <input type="checkbox"/> Stone <input type="checkbox"/> Burnt stone <input type="checkbox"/> Glass <input type="checkbox"/> Metal <input type="checkbox"/> CBM <input type="checkbox"/> Wood <input type="checkbox"/> Leather <input type="checkbox"/>				
Δ Small Finds			Recorder <i>DS</i>	
◇ Samples			Date <i>9/10</i>	
△ Building Materials			Initials	

SITE <i>OL200</i>	<b>CONTEXT RECORD</b>	Context No. <i>548</i>
Additional Sheets:		Type <i>STRUCTURE</i>
Trench	Context Type: Deposit / Cut / <u>Structure</u>	Check Lists:
Site sub-div <i>N.C.</i>	Overlain by:	DEPOSIT: 1.compaction 2.colour 3.composition 4.inclusions 5.thickness 6.extent 7.comments 8.method & conditions
Structure No.	Abutted by:	
Plan No. <i>3</i>	Cut by:	CUT: 1.shape in plan 2.base/sides/top profile 3.dimension and depth 4.sketch 5.truncation 6.fill nos 7.other comments
Section No.	Filled by:	
Co-Ordinates	Same as:	MASONRY: 1.materials 2.size of bricks etc 3.finish of stones 4.coursing/bond 5.form 6.faces 7.bond 8.dimensions as found 9.other comments
	Part of:	
Level	Butts:	
Slide No.	Cuts:	
Neg No.	Fill of:	
Matrix location	Relationships uncertain	
Description (See check lists): <i>Brick base, 1.75m x 0.80m, 5 courses thick with centre "cross bar"</i>		STRATIGRAPHIC MATRIX 
<i>C. 0.30m below modern ground surface.</i>		
Interpretation/Discussion: <i>Brick support for ledger/monument</i>		
Finds (tick): None <input type="checkbox"/> Pot <input type="checkbox"/> Bone <input type="checkbox"/> Flint <input type="checkbox"/> Stone <input type="checkbox"/> Burnt stone <input type="checkbox"/> Glass <input type="checkbox"/> Metal <input type="checkbox"/> CBM <input type="checkbox"/> Wood <input type="checkbox"/> Leather <input type="checkbox"/>		
ΔSmall Finds		Recorder <i>DS</i>
◇Samples		Date <i>9/10</i>
ΔBuilding Materials		Initials

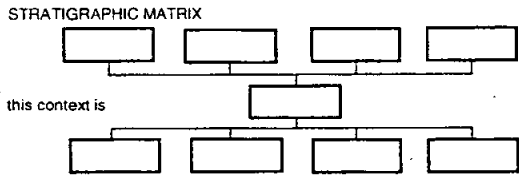

SITE <i>OLR00</i>	<b>CONTEXT RECORD</b>	Context No. <i>549</i>
Additional Sheets:		Type <i>STRUCTURE</i>
Trench	Context Type: Deposit / Cut ( <i>Structure</i> )	Check Lists:
Site sub-div <i>N.C.</i>	Overlain by:	DEPOSIT: 1.compaction 2.colour 3.composition 4.inclusions 5.thickness 6.extent 7.comments 8.method & conditions
Structure No.	Abutted by:	
Plan No. <i>3</i>	Cut by:	CUT: 1.shape in plan 2.base/sides/top profile 3.dimension and depth 4.sketch 5.truncation 6.fill nos 7.other comments
	Filled by:	
Section No.	Same as:	MASONRY: 1.materials 2.size of bricks etc 3.finish of stones 4.coursing/bond 5.form 6.faces 7.bond 8.dimensions as found 9.other comments
	Part of:	
Co-Ordinates	Consists of:	
	Overlies:	
Level	Butts:	
Slide No.	Cuts:	
Neg No.	Fill of:	
Matrix location	Relationships uncertain	
Description (See check lists): <i>Brick base - 1.70x0.90 x 5 courses thick.</i>		STRATIGRAPHIC MATRIX 
<i>C. 0.30m below modern ground surface.</i>		
Interpretation/Discussion: <i>Brick support for ledger/monument.</i>		
Finds (tick): None <input type="checkbox"/> Pot <input type="checkbox"/> Bone <input type="checkbox"/> Flint <input type="checkbox"/> Stone <input type="checkbox"/> Burnt stone <input type="checkbox"/> Glass <input type="checkbox"/> Metal <input type="checkbox"/> CBM <input type="checkbox"/> Wood <input type="checkbox"/> Leather <input type="checkbox"/>		
ΔSmall Finds		Recorder <i>DS</i>
◇Samples		Date <i>9/10</i>
△Building Materials		Initials

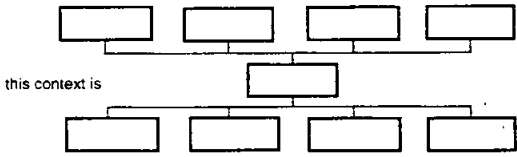
SITE OLR00	CONTEXT RECORD		Context No. 550
Trench	Additional Sheets:		Type STRUCTURE
Site sub-div N.C.	Context Type: Deposit / Cut / <u>Structure</u>		Check Lists:
Structure No.	Overlain by:	DEPOSIT: 1.compaction 2.colour 3.composition 4.inclusions 5.thickness 6.extent 7.comments 8.method & conditions	
Plan No. 3	Abutted by:		
Section No.	Cut by:	CUT: 1.shape in plan 2.base/sides/top profile 3.dimension and depth 4.sketch 5.truncation 6.fill nos 7.other comments	
Co-Ordinates	Filled by:		
Level	Same as:	MASONRY: 1.materials 2.size of bricks etc 3.finish of stones 4.coursing/bond 5.form 6.faces 7.bond 8.dimensions as found 9.other comments	
Slide No.	Part of:		
Neg No.	Consists of:		
Matrix location	Overlies:		
Matrix location	Butts:		
Matrix location	Cuts:		
Matrix location	Fill of:		
Matrix location	Relationships uncertain		
Description (See check lists): Stone block surround on stone slabs set on a birch base support. 1.95 x 0.95m C. 0.30m below modern ground surface.		STRATIGRAPHIC MATRIX 	
Interpretation/Discussion: stone base for monument.			
Finds (tick): None <input type="checkbox"/> Pot <input type="checkbox"/> Bone <input type="checkbox"/> Flint <input type="checkbox"/> Stone <input type="checkbox"/> Burnt stone <input type="checkbox"/> Glass <input type="checkbox"/> Metal <input type="checkbox"/> CBM <input type="checkbox"/> Wood <input type="checkbox"/> Leather <input type="checkbox"/>			
Δ Small Finds			Recorder DS
◇ Samples			Date 9/10
Δ Building Materials			Initials

SITE		CONTEXT RECORD		Context No.
OLR00		Additional Sheets:		551
Trench	Context Type: Deposit / Cut / <u>Structure</u>		Type <u>STRUCTURE</u>	
Site sub-div	N.C.	Overlain by:	Check Lists:	
Structure No.		Abutted by:	DEPOSIT:	
Plan No.	3	Cut by:	1.compaction 2.colour 3.composition 4.inclusions 5.thickness 6.extent 7.comments 8.method & conditions	
Section No.		Filled by:	CUT:	
Co-Ordinates		Same as:	1.shape in plan 2.base/sides/top profile 3.dimension and depth 4.sketch 5.truncation 6.fill nos 7.other comments	
Level		Part of:	MASONRY:	
Slide No.		Consists of:	1.materials 2.size of bricks etc 3.finish of stones 4.coursing/bond 5.form 6.faces 7.bond 8.dimensions as found 9.other comments	
Neg No.		Overlies:		
Matrix location		Butts:		
Description (See check lists):		Cuts:		
Brick base - 1.60 x 0.70m		Fill of:		
2-3 courses thick.		Relationships uncertain		
C. 0.35m below ground level			<p>STRATIGRAPHIC MATRIX</p>	
Interpretation/Discussion:				
Brick base for ledger stone.				
Finds (tick): None <input type="checkbox"/> Pot <input type="checkbox"/> Bone <input type="checkbox"/> Flint <input type="checkbox"/> Stone <input type="checkbox"/> Burnt stone <input type="checkbox"/> Glass <input type="checkbox"/> Metal <input type="checkbox"/> CBM <input type="checkbox"/> Wood <input type="checkbox"/> Leather <input type="checkbox"/>				
△Small Finds			Recorder DS	
◇Samples			Date 9/10	
△Building Materials			Initials	

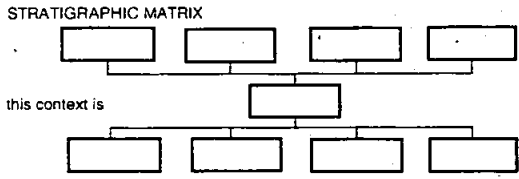
SITE <i>OL200</i>	<b>CONTEXT RECORD</b>	Context No. <i>552</i>
Additional Sheets:		Type <i>STRUCTURE</i>
Trench	Context Type: Deposit / Cut / <u>Structure</u>	Check Lists:
Site sub-div <i>N.C.</i>	Overlain by:	DEPOSIT: 1.compaction 2.colour 3.composition 4.inclusions 5.thickness 6.extent 7.comments 8.method & conditions
Structure No.	Abutted by:	
Plan No. <i>3</i>	Cut by:	CUT: 1.shape in plan 2.base/sides/top profile 3.dimension and depth 4.sketch 5.truncation 6.fill nos 7.other comments
Section No.	Filled by:	
Co-Ordinates	Same as:	MASONRY: 1.materials 2.size of bricks etc 3.finish of stones 4.coursing/bond 5.form 6.faces 7.bond 8.dimensions as found 9.other comments
Level	Part of:	
Slide No.	Consists of:	
Neg No.	Overlies:	
Matrix location	Butts:	
Relationships uncertain		
Description (See check lists): <i>brick base, 2x1m - 5 courses                  deep.</i>		STRATIGRAPHIC MATRIX 
<i>C. 0.25m below modern ground level.</i>		
Interpretation/Discussion: <i>Brick base support for ledger/monument.</i>		
Finds (tick): None <input type="checkbox"/> Pot <input type="checkbox"/> Bone <input type="checkbox"/> Flint <input type="checkbox"/> Stone <input type="checkbox"/> Burnt stone <input type="checkbox"/> Glass <input type="checkbox"/> Metal <input type="checkbox"/> CBM <input type="checkbox"/> Wood <input type="checkbox"/> Leather <input type="checkbox"/>		
ΔSmall Finds		Recorder <i>DS</i>
◇Samples		Date <i>9/10</i>
ΔBuilding Materials		Initials

SITE		CONTEXT RECORD		Context No.
02R00		Additional Sheets:		553
Trench	Context Type: Deposit / Cut / <u>Structure</u>		Type <u>STRUCTURE</u>	
Site sub-div	N.C.	Overlain by:	Check Lists:	
Structure No.		Abutted by:	DEPOSIT:	
Plan No.	3	Cut by:	1.compaction 2.colour 3.composition 4.inclusions 5.thickness 6.extent 7.comments 8.method & conditions	
		Filled by:	CUT:	
Section No.		Same as:	1.shape in plan 2.base/sides/top profile 3.dimension and depth 4.sketch 5.truncation 6.fill nos 7.other comments	
		Part of:	MASONRY:	
Co-Ordinates		Consists of:	1.materials 2.size of bricks etc 3.finish of stones 4.coursing/bond 5.form 6.faces 7.bond 8.dimensions as found 9.other comments	
		Overlies:		
Level		Butts:		
Slide No.		Cuts:		
Neg No.		Fill of:		
Matrix location		Relationships uncertain		
Description (See check lists):		STRATIGRAPHIC MATRIX		
Brick base - full extent not seen				
- truncation at east end?				
C 0.40m below modern ground level.				
Interpretation/Discussion:		Brick base for ledger/monument		
Finds (tick): None <input type="checkbox"/> Pot <input type="checkbox"/> Bone <input type="checkbox"/> Flint <input type="checkbox"/> Stone <input type="checkbox"/> Burnt stone <input type="checkbox"/> Glass <input type="checkbox"/> Metal <input type="checkbox"/>				
CBM <input type="checkbox"/> Wood <input type="checkbox"/> Leather <input type="checkbox"/>				
ΔSmall Finds			Recorder DS	
◇Samples			Date 9/10	
△Building Materials			Initials	

SITE <i>04200</i>		CONTEXT RECORD		Context No. <i>SS4</i>
Additional Sheets:		Type <i>STRUCTURE</i>		
Trench	Context Type: Deposit / Cut / <u>Structure</u>		Check Lists:	
Site sub-div <i>N.C.</i>	Overlain by:	DEPOSIT:		
Structure No.	Abutted by:	1.compaction 2.colour 3.composition 4.inclusions 5.thickness 6.extent 7.comments 8.method & conditions		
Plan No. <i>3</i>	Cut by:	CUT:		
	Filled by:	1.shape in plan 2.base/sides/top profile 3.dimension and depth 4.sketch 5.truncation 6.fill nos 7.other comments		
Section No.	Same as:	MASONRY:		
	Part of:	1.materials 2.size of bricks etc 3.finish of stones 4.coursing/bond 5.form 6.faces 7.bond 8.dimensions as found 9.other comments		
Co-Ordinates	Consists of:			
	Overlies:			
Level	Butts:			
Slide No.	Cuts:			
Neg No.	Fill of:			
Matrix location	Relationships uncertain			

Description (See check lists):  
*Stone blocks on brick base - full extent not seen - truncated at east end.*

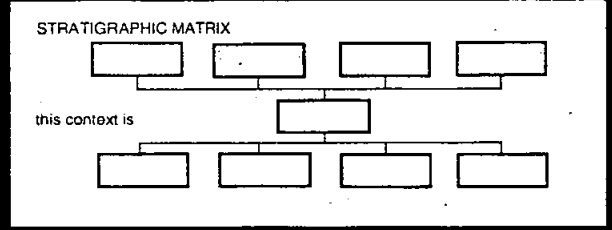

*C 0.40 m below modern ground level.*

Interpretation/Discussion:  
*stone/brick base for monument*

Finds (tick): None  Pot  Bone  Flint  Stone  Burnt stone  Glass  Metal   
 CBM  Wood  Leather

ΔSmall Finds	Recorder <i>DS</i>
◇Samples	Date <i>9/10</i>
ΔBuilding Materials	Initials

SITE <b>OLR00</b>		CONTEXT RECORD		Context No. <b>555</b>
Additional Sheets: <b>YES 1</b>				Type <b>STRUCTURE</b>
Trench	Context Type: Deposit / Cut / <b>Structure</b>		Check Lists:	
Site sub-div <b>N.C.</b>	Overlain by: <b>3</b>			DEPOSIT: 1.compaction 2.colour 3.composition 4.inclusions 5.thickness 6.extent 7.comments 8.method & conditions
Structure No.	Abutted by:			
Plan No. <b>3</b>	Cut by:			CUT: 1.shape in plan 2.base/sides/top profile 3.dimension and depth 4.sketch 5.truncation 6.fpnos 7.other comments
	Filled by: <b>(460)</b>			
Section No.	Same as:			MASONRY: 1.materials 2.size of bricks etc 3.finish of stones 4.coursing/bond 5.form 6.faces 7.bond 8.dimensions as found 9.other comments
	Part of:			
Co-Ordinates	Consists of:			
	Overlies:			
Level	Butts:			
Slide No.	Cuts:			
Neg No.	Fill of:			
Matrix location	Relationships uncertain			
Description (See check lists):		STRATIGRAPHIC MATRIX		
<b>Brick grave . 2.50 x 1.50m</b>		<pre> graph TD     A[ ] --- B[ ]     A --- C[ ]     A --- D[ ]     A --- E[ ]     B --- F[ ]     C --- F     D --- F     E --- F     F --- G[ ]     G --- H[ ]     G --- I[ ]     G --- J[ ]     G --- K[ ]     </pre>		
<b>3m deep - contains burial</b>		this context is		
<b>(460) - capped with 3 stone</b>		<pre> graph TD     A[ ] --- B[ ]     A --- C[ ]     A --- D[ ]     A --- E[ ]     B --- F[ ]     C --- F     D --- F     E --- F     F --- G[ ]     G --- H[ ]     G --- I[ ]     G --- J[ ]     G --- K[ ]     </pre>		
<b>Slabs overlain by single slab/ledger. (13)</b>				
Interpretation/Discussion:		<b>BRICK GRAVE - under monument 13</b>		
<b>&amp; contains burial (460)</b>				
Finds (tick): None <input type="checkbox"/> Pot <input type="checkbox"/> Bone <input type="checkbox"/> Flint <input type="checkbox"/> Stone <input type="checkbox"/> Burnt stone <input type="checkbox"/> Glass <input type="checkbox"/> Metal <input type="checkbox"/>				
CBM <input type="checkbox"/> Wood <input type="checkbox"/> Leather <input type="checkbox"/>				
ΔSmall Finds		Recorder <b>JS</b>		
◇Samples		Date <b>9/10</b>		
△Building Materials		Initials		

SITE <i>OL200</i>		CONTEXT RECORD		Context No. <i>557</i>
Additional Sheets:				Type <i>STRUCTURE</i>
Trench	Context Type: Deposit / Cut <u>Structure</u>		Check Lists:	
Site sub-div <i>N.C.</i>	Overlain by:		DEPOSIT:	
Structure No.	Abutted by:		1.compaction 2.colour 3.composition 4.inclusions 5.thickness 6.extent 7.comments 8.method & conditions	
Plan No. <i>3</i>	Cut by:		CUT:	
Section No.	Filled by: <i>contains burials (671) / (672)</i>		1.shape in plan 2.base/sides/top profile 3.dimension and depth 4.sketch 5.truncation 6.fill nos 7.other comments	
Co-Ordinates	Same as:		MASONRY:	
Level	Part of:		1.materials 2.size of bricks etc 3.finish of stones 4.coursing/bond 5.form 6.faces 7.bond 8.dimensions as found 9.other comments	
Slide No. <i>Film 25/26.</i>	Consists of:			
Neg No.	Overlies:			
Matrix location	Butts:			
	Cuts:			
	Fill of:			
	Relationships uncertain			

Description (See check lists):

*Brick grave :- 2.30 x ~~1.5m~~ 1.5m  
x 3.60m deep below ground surface. - covered  
with 3 stone slabs across grave.*

*- situation on northern edge of site - no visible marker on ground - seen  
0.25m below ground surface - backfilled with rubble - 2 burials in  
base - resting on brick floor. - removed by machine, as unsafe  
to do by hand.*

STRATIGRAPHIC MATRIX

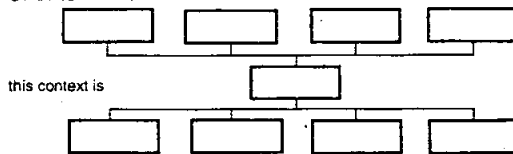

Interpretation/Discussion:

BRICK GRAVES (2 wood coffin burials).

Finds (tick): None  Pot  Bone  Flint  Stone  Burnt stone  Glass  Metal   
CBM  Wood  Leather

ΔSmall Finds

◇Samples

△Building Materials

Recorder *DS*

Date *9/10*

Initials



SITE <i>OL-ROO</i>		CONTEXT RECORD		Context No. <i>558</i>
Additional Sheets:		Type <i>Structure</i>		
Trench	Context Type: Deposit / Cut / <u>Structure</u>		Check Lists:	
Site sub-div <i>N.C.</i>	Overlain by:		DEPOSIT:	
Structure No.	Abutted by:		1.compaction 2.colour 3.composition	
Plan No. <i>3</i>	Cut by:		4.inclusions 5.thickness 6.extent 7.comments 8.method & conditions	
	Filled by:			
Section No.	Same as:		CUT:	
	Part of:		1.shape in plan 2.base/sides/top profile 3.dimension and depth 4.sketch 5.truncation 6.ft. nos 7.other comments	
Co-Ordinates	Consists of:			
	Overlies:			
Level	Butts:		MASONRY:	
Slide No.	Cuts:		1.materials 2.size of bricks etc 3.finish of stones 4.coursing/bond 5.form 6.faces 7.bond 8.dimensions as found 9.other comments	
Neg No.	Fill of:			
Matrix location	Relationships uncertain			
Description (See check lists):			STRATIGRAPHIC MATRIX	
<i>ledger stone 2 x 0.90m</i>				
<i>plain 0.15m thick</i>				
Interpretation/Discussion:				
<i>masonry base / support for ledger.</i>				
Finds (tick): None <input type="checkbox"/> Pot <input type="checkbox"/> Bone <input type="checkbox"/> Flint <input type="checkbox"/> Stone <input type="checkbox"/> Burnt stone <input type="checkbox"/> Glass <input type="checkbox"/> Metal <input type="checkbox"/>				
CBM <input type="checkbox"/> Wood <input type="checkbox"/> Leather <input type="checkbox"/>				
ΔSmall Finds			Recorder <i>DS</i>	
◇Samples			Date <i>9/10</i>	
△Building Materials			Initials	

SITE <i>OLR00</i>	<b>CONTEXT RECORD</b>	Context No. <i>559</i>
Trench	Additional Sheets:	Type <i>STRUCTURE</i>
Site sub-div <i>N.C.</i>	Context Type: Deposit / Cut / <u>Structure</u>	Check Lists:
Structure No.	Overlain by:	DEPOSIT:
Plan No. <i>3</i>	Abutted by:	1.compaction 2.colour 3.composition 4.inclusions 5.thickness 6.extent 7.comments 8.method & conditions
Section No.	Cut by:	CUT:
	Filled by:	1.shape in plan 2.base/sides/top profile 3.dimension and depth 4.sketch 5.truncation 6.fill nos 7.other comments
Co-Ordinates	Same as:	MASONRY:
Level	Part of: <i>109</i> ?	1.materials 2.size of bricks etc 3.finish of stones 4.coursing/bond 5.form 6.faces 7.bond 8.dimensions as found 9.other comments
Slide No.	Consists of:	
Neg No.	Overlies:	
Matrix location	Butts:	
	Cuts:	
	Fill of:	
	Relationships uncertain	

Description (See check lists):  
*Brick structure - butts vault 109 (under  
 vestig) on its west side. Brick walls  
 0.60m thick - seen to a depth of  
 0.93m (c. 1.5m below ground level)*

*In line with 'hooked' entrance to vault 109 & const' appears contemporaneous  
 could have been intended as a well for 'steps'??*

STRATIGRAPHIC MATRIX

Interpretation/Discussion:  
*POD part of vault 109 - surround for entrance?*

Finds (tick): None  Pot  Bone  Flint  Stone  Burnt stone  Glass  Metal   
 CBM  Wood  Leather

△Small Finds	Recorder <i>JS</i>
◇Samples	Date <i>9/10</i>
△Building Materials	Initials

SITE <i>OLR00</i>		CONTEXT RECORD		Context No. <i>560</i>
Additional Sheets:		Type <i>STRUCTURE</i>		
Trench	Context Type: Deposit / Cut / <u>Structure</u>		Check Lists:	
Site sub-div <i>N.C.</i>	Overlain by:	DEPOSIT:		
Structure No.	Abutted by:	1.compaction 2.colour 3.composition 4.inclusions 5.thickness 6.extent 7.comments 8.method & conditions		
Plan No. <i>3</i>	Cut by:	CUT:		
Section No.	Filled by:	1.shape in plan 2.base/sides/top profile 3.dimension and depth 4.sketch 5.truncation 6.fill nos 7.other comments		
Co-Ordinates	Same as:	MASONRY:		
Level	Part of:	1.materials 2.size of bricks etc 3.finish of stones 4.coursing/bond 5.form 6.faces 7.bond 8.dimensions as found 9.other comments		
Slide No.	Consists of:			
Neg No.	Overlies:			
Matrix location	Butts:			
	Cuts:			
	Fill of:			
	Relationships uncertain			
Description (See check lists):		STRATIGRAPHIC MATRIX		
<i>Brick structure - 1 brick width to 0.80m square. seen to a depth of c. 1m? from c. 0.30-40m below ground level.</i>				
Interpretation/Discussion:		<i>pos manhole? (not really sure what this is)</i>		
Finds (tick): None <input type="checkbox"/> Pot <input type="checkbox"/> Bone <input type="checkbox"/> Flint <input type="checkbox"/> Stone <input type="checkbox"/> Burnt stone <input type="checkbox"/> Glass <input type="checkbox"/> Metal <input type="checkbox"/> CBM <input type="checkbox"/> Wood <input type="checkbox"/> Leather <input type="checkbox"/>				
ΔSmall Finds			Recorder <i>DS</i>	
◇Samples			Date <i>9/10</i>	
△Building Materials			Initials	

SITE <b>OLR00</b>		CONTEXT RECORD		Context No. <b>561</b>
Additional Sheets:		Type <b>STRUCTURE</b>		
Trench	Context Type: Deposit / Cut / <b>Structure</b>		Check Lists:	
Site sub-div <b>N.C.</b>	Overlain by:	DEPOSIT:		
Structure No.	Abutted by:	1.compaction 2.colour 3.composition 4.inclusions 5.thickness 6.extent 7.comments 8.method & conditions		
Plan No. <b>3</b>	Cut by:	CUT:		
Section No.	Filled by:	1.shape in plan 2.base/sides/top profile 3.dimension and depth 4.sketch 5.truncation 6.fill nos 7.other comments		
Co-Ordinates	Same as:	MASONRY:		
Level	Part of:	1.materials 2.size of bricks etc 3.finish of stones 4.coursing/bond 5.form 6.faces 7.bond 8.dimensions as found 9.other comments		
Slide No.	Consists of:			
Neg No.	Overlies:			
Matrix location	Butts:			
	Cuts:			
	Fill of:			
	Relationships uncertain			
Description (See check lists):		STRATIGRAPHIC MATRIX		
<b>Stone slab - 0.15m thick, 1.70 x 0.95m - support for ledger or monument</b>				
Interpretation/Discussion:		<b>Stone support for ledger/monument.</b>		
Finds (tick): None <input type="checkbox"/> Pot <input type="checkbox"/> Bone <input type="checkbox"/> Flint <input type="checkbox"/> Stone <input type="checkbox"/> Burnt stone <input type="checkbox"/> Glass <input type="checkbox"/> Metal <input type="checkbox"/> CBM <input type="checkbox"/> Wood <input type="checkbox"/> Leather <input type="checkbox"/>				
ΔSmall Finds			Recorder <b>DS</b>	
◇Samples			Date <b>9/10</b>	
△Building Materials			Initials	

SITE <i>OLR00</i>		CONTEXT RECORD		Context No. <i>562</i>
Additional Sheets:		Type <i>STRUCTURE</i>		
Trench	Context Type: Deposit / Cut / <u>Structure</u>		Check Lists:	
Site sub-div <i>N.C.</i>	Overlain by:		DEPOSIT:	
Structure No.	Abutted by:		1.compaction 2.colour 3.composition	
Plan No. <i>3</i>	Cut by:		4.inclusions 5.thickness 6.extend/7.comments	
Section No.	Filled by:		8.method & conditions	
Co-Ordinates	Same as:		CUT:	
Level	Part of:		1.shape in plan 2.base/sides/top profile	
Slide No.	Consists of:		3.dimension and depth 4.sketch 5.truncation	
Neg No.	Overlies:		6.fill nos 7.other comments	
Matrix location	Butts:		MASONRY:	
	Cuts:		1.materials 2.size of bricks etc 3.finish of stones 4.coursing/bond	
	Fill of:		5.form 6.faces 7.bond 8.dimensions as found 9.other comments	
	Relationships uncertain			
Description (See check lists):		STRATIGRAPHIC MATRIX		
<i>Support for ledges? - Stone - truncated to west side.</i>				
<i>c. 0.30 - below ground level</i>				
Interpretation/Discussion:		<i>Truncated Support for ledge/monument?</i>		
Finds (tick): None <input type="checkbox"/> Pot <input type="checkbox"/> Bone <input type="checkbox"/> Flint <input type="checkbox"/> Stone <input type="checkbox"/> Burnt stone <input type="checkbox"/> Glass <input type="checkbox"/> Metal <input type="checkbox"/> CBM <input type="checkbox"/> Wood <input type="checkbox"/> Leather <input type="checkbox"/>				
ΔSmall Finds			Recorder <i>DS</i>	
◇Samples			Date <i>9/10</i>	
△Building Materials			Initials	

db

SITE	COFFIN RECORD SHEET	CONTEXT NO.
02200		563
Trench: CRPT	Additional sheets:	Treatment: Skelly lifted & DNA taken
Site sub-div:	Grave fills	
Plan no: 7	Grave cut:	Finds
Section no:	Skeleton:	None inscription (a) Breastplate u plate (top) pb x 2 Grip (c) foot? plate pb.
Co-ordinates:	Matrix location: in Bay A	Hinge + 2 x te grip spfals (c)
Levels	Preservation: 3	Bracket Fixing nails Shroud pins
Slide No.	Neg No:	Fabric Other finds

Description: adult p.b. coffin

Discussion:

Shape, dimensions and distinguishing characteristics

LID

HEAD

BASE

1  
0.23  
0.47  
1.73  
0.30 = deep  
0.23  
0.15

(a) "William J. Casghill  
Died 24<sup>th</sup> Jan  
1832  
In his 25<sup>th</sup> year"

(b) "Mr William Johnson Casghill.  
Died 24 Jan  
1832  
In his 25<sup>th</sup> year"

(c) "Mr William Johnson Casghill  
∴ 1832"

= spfals  
(2) w/ diff border (top)

Recorder:	Date: 9/10	Initials: MK
-----------	------------	--------------

SITE		COFFIN RECORD SHEET		CONTEXT NO.	
OLR 00				564	
Trench:		Additional sheets:		Treatment: Bones collected.	
Site sub-div: NL		Grave fills: —			
Plan no: 3		Grave cut: —		Finds	
				None	
Section no:		Skeleton: 564		Breastplate	
				Grip	
Co-ordinates:		Matrix location: 526		Hinge	
		527		Bracket	
		564		Fixing nails	
Levels		Preservation: 565		Shroud pins	
Slide No.		Neg No:		Fabric	
				Other finds	
Description: Adult 6-0 TRUNCATED					
Discussion					
Shape, dimensions and distinguishing characteristics					
LID					
HEAD					
BASE					
Recorder: JH		Date: 9/10/00		Initials:	

SITE <i>OLR00</i>		COFFIN RECORD SHEET	CONTEXT NO. <i>565</i>
Trench:	Additional sheets:	Treatment:	
Site sub-div: <i>NC</i>	Grave fills:	<i>BONE COLLECTED</i>	
Plan no: <i>3</i>	Grave cut:	Finds	
Section no:	Skeleton: <i>565</i>	None	
Co-ordinates:	Matrix location: <i>564</i> <i>565</i>	Breastplate	
Levels:	Preservation: <i>FAIR</i>	Grip	
Slide No.:	Neg No.:	Hinge	
Description <i>6-w Adult.</i>		Bracket	
Discussion		Fixing nails	
Shape, dimensions and distinguishing characteristics		Shroud pins	
LID		Fabric	
HEAD		Other finds	
BASE			
Recorder: <i>JH</i>	Date: <i>9/10/00</i>	Initials:	



SITE 04/200		COFFIN RECORD SHEET		CONTEXT NO. 566	
Trench:	Additional sheets:	Treatment: BONE COLLECTOR!!			
Site sub-div: NC	Grave fills:				
Plan no: 3	Grave cut:	Finds			
Section no:	Skeleton: 566	None			
Co-ordinates:	Matrix location: 530 566 567	Breastplate			
Levels	Preservation: GOOD	Grip			
Slide No.	Neg No:	Hinge			
Description		Bracket			
Discussion		Fixing nails			
Shape, dimensions and distinguishing characteristics		Shroud pins			
LID		Fabric			
HEAD		Other finds			
BASE					
Recorder: JH	Date: 2/10/00	Initials:			

Site Code

Context

02200

566

**Outer Coffin**

Sample Ret.

Recording Date ..... 16/2/01 .....

Associated Numbers .....

Condition .....

Dep. Plate

Legible

Inscription

Fabric lead  ormolou  brass  tin plated pewter  gilt tin   
 iron  silvered tin  enamelled  other ..... Sample Ret.

**Shape of dep. plate**

square  rectangle  shield  tapered  lozenge   
 cartouche  oval  other .....

**Upholstery**

colour ..... shoddy  velvet  other ..... Sample Ret.

**Construction**

butt joint  mitred  pitched  other .....

**Grip plate**

Fabric = ormolou  brass  tin plated pewter  gilt tin   
 iron  silvered tin  enamelled  other ..... Sample Ret.

**Grip**

Fabric = ormolou  brass  iron  Sample Ret.

**Design**

swag of rose  horseshoe  cherub's head  plain   
 other .....

**Grip bolts**

Corner bolts  Type = gilt brass  brass  iron   
 other ..... Sample Ret.

**Lid motifs**

other ..... Sample Ret.

**Escutcheons**

other ..... Sample Ret.

**Upholstery**

*studs*  
 nails  brass  gilt brass  silvered brass  iron  enamelled   
 other *4 pieces / 1x 000 / 1x 0000000000 / 1x 0000000000 / 1x 0000000000 = 54 studs* Sample Ret.

**Fixings**

panel nails  screws  hinges  lace  Sample Ret.

**Timber type** .....

Sample Ret.

**Interpretation / Comments**

.....  
 .....

SITE		COFFIN RECORD SHEET		CONTEXT NO.	
02200				567	
Trench:		Additional sheets:		Treatment:	
Site sub-div: NC		Grave fills		Bones collected	
Plan no: 3		Grave cut:		Finds	
Section no:		Skeleton: 567		None	
Co-ordinates:		Matrix location: 567 567		Breastplate	
Levels		Preservation: good		Grip	
Slide No.		Neg No:		Hinge	
Description: 6-6 Adult				Bracket	
Discussion				Fixing nails	
Shape, dimensions and distinguishing characteristics				Shroud pins	
LID				Fabric	
HEAD				Other finds	
BASE:					
Recorder: <i>[Signature]</i>		Date: 2/10/00		Initials:	

**Outer Coffin**

Sample Ret.

Site Code

Context

OKR00

567

Recording Date ..... 21/2/01 .....

Associated Numbers .....

Condition .....

Dep. Plate

Legible

Inscription

Fabric lead       ormolou       brass       tin plated pewter       gilt tin   
 iron       silvered tin       enamelled       other .....      Sample Ret.

**Shape of dep. plate**

square       rectangle       shield       tapered       lozenge   
 cartouche       oval       other .....

**Upholstery**

colour .....      shoddy       velvet       other .....      Sample Ret.

**Construction**

butt joint       mitred       pitched       other .....

**Grip plate**

Fabric = ormolou       brass       tin plated pewter       gilt tin   
*frag on lev. of grip-wood.*  
 iron       silvered tin       enamelled       other .....      Sample Ret.

**Grip**

Fabric = ormolou       brass       iron  2x      Sample Ret.

**Design**

swag of rose       horseshoe       cherub's head       (36)'s      plain

other .....

**Grip bolts**

**Corner bolts**       Type =      gilt brass       brass       iron

other .....      Sample Ret.

**Lid motifs**

other .....      Sample Ret.

**Escutcheons**

other .....      Sample Ret.

**Upholstery nails**

brass       gilt brass       silvered brass       iron       enamelled

other .....      Sample Ret.

**Fixings**

panel nails       screws       hinges       lace       Sample Ret.

**Timber type**

.....      Sample Ret.

**Interpretation / Comments**

.....  
 .....

SITE <i>OLROE</i>	COFFIN RECORD SHEET	CONTEXT NO. <i>568</i>
Trench:	Additional sheets:	Treatment: <i>BONE COLLECTED</i>
Site sub-div: <i>NC</i>	Grave fills:	
Plan no: <i>3</i>	Grave cut:	Finds None
Section no:	Skeleton: <i>568</i>	Breastplate Grip
Co-ordinates:	Matrix location:	Hinge Bracket
Levels	Preservation:	Fixing nails Shroud pins
Slide No.	Neg No:	Fabric Other finds :
Description <i>6-w child burial</i>		
Discussion		
Shape, dimensions and distinguishing characteristics		
LID		
HEAD		
BASE		
Recorder: <i>[Signature]</i>	Date: <i>9/10/60</i>	Initials:

SITE <i>02200</i>		COFFIN RECORD SHEET		CONTEXT NO. <i>569</i>	
Trench:		Additional sheets:		Treatment:	
Site sub-div: <i>NE</i>		Grave fills:		<i>BONE COLLECTOR</i>	
Plan no: <i>3</i>		Grave cut:		Finds	
Section no:		Skeleton: <i>300 569</i>		None	
Co-ordinates:		Matrix location: <i>569</i> <i>571</i>		Breastplate	
Levels:		Preservation:		Grip	
Slide No.:		Neg No.:		Hinge	
Description: <i>E-W Adult</i>				Bracket	
Discussion:				Fixing nails	
Shape, dimensions and distinguishing characteristics:				Shroud pins	
LID:				Fabric	
HEAD:				Other finds	
BASE:					
Recorder: <i>JH</i>		Date: <i>20/10/00</i>		Initials:	

Site Code

Context

**Outer Coffin**

Sample Ret.

OR00

569

Recording Date ..... 16/2/01 .....

Associated Numbers .....

Condition .....

Dep. Plate

Legible

Inscription

Fabric lead  ormolou  brass  tin plated pewter  gilt tin   
 iron  silvered tin  enamelled  other ..... Sample Ret.

**Shape of dep. plate**

square  rectangle  shield  tapered  lozenge   
 cartouche  oval  other .....

**Upholstery**

colour ..... shoddy  velvet  other ..... Sample Ret.

**Construction**

butt joint  mitred  pitched  other .....

Grip plate  Fabric = ormolou  brass  tin plated pewter  gilt tin   
 iron  *Feeds on lev. of grip-wood.* silvered tin  enamelled  other ..... Sample Ret.

Grip  Fabric = ormolou  brass  iron  x 4 Sample Ret.

Design swag of rose  horseshoe  cherub's head  plain   
 other ..... <sup>(4)5</sup>

Grip bolts  Corner bolts  Type = gilt brass  brass  iron   
 other ..... Sample Ret.

Lid motifs  other ..... Sample Ret.

Escutcheons  other ..... Sample Ret.

Upholstery <sup>studs</sup>  brass  gilt brass  silvered brass  iron  enamelled   
 other ..... *4 x peils 1 x 000 / 1 x 0000 / 2 x 000 = 19 studs* Sample Ret.

Fixings  panel nails  screws  hinges  lace  Sample Ret.

Timber type ..... Sample Ret.

**Interpretation / Comments**

.....  
 .....

SITE	COFFIN RECORD SHEET	CONTEXT NO.
0L200		570
Trench:	Additional sheets:	Treatment:
Site sub-div: NC	Grave fills	BONE COLLECTED
Plan no: 3	Grave cut:	Finds
Section no:	Skeleton: 570	None
Co-ordinates:	Matrix location: 521 570	Breastplate
Levels	Preservation: GOOD	Grip
Slide No.	Neg No:	Hinge
		Bracket
		Fixing nails
		Shroud pins
		Fabric
		Other finds

**Description**  
 5-6 Adult Truncated  
 Remains of another individual (Cranial fragments, CVs+TV, + clavicle) retrieved during  
**Discussion**  
 Osteological analysis → 1313

**Shape, dimensions and distinguishing characteristics**

LID

HEAD

BASE

Recorder: JH	Date: 9/10/02	Initials:
--------------	---------------	-----------



SITE	COFFIN RECORD SHEET	CONTEXT NO.
04/00		571
Trench:	Additional sheets:	Treatment:
Site sub-div: <i>we</i>	Grave fills	<i>BWTG COLLECTED</i>
Plan no: <i>B</i>	Grave cut:	Finds
Section no:	Skeleton:	None
Co-ordinates:	Matrix location: <i>571</i>	Breastplate
Levels	Preservation: <i>569</i> <i>571</i>	Grip
Slide No.	Neg No:	Hinge
Description		Bracket
Discussion		Fixing nails
Shape, dimensions and distinguishing characteristics		Shroud pins
LID		Fabric
HEAD		Other finds
BASE		
Recorder:	Date:	Initials:

*E-W Adult*

# Coffin Recording Sheet

Site Code

Context

0h200

571

**Outer Coffin**

Sample Ret.

Recording Date ..... 16/2/01 .....

Associated Numbers .....

Condition .....

Dep. Plate

Legible

Inscription

Fabric lead  ormolou  brass  tin plated pewter  gilt tin   
 iron  silvered tin  enamelled  other ..... Sample Ret.

**Shape of dep. plate**

square  rectangle  shield  tapered  lozenge   
 cartouche  oval  other .....

**Upholstery**

colour ..... shoddy  velvet  other ..... Sample Ret.

**Construction**

butt joint  mitred  pitched  other .....

**Grip plate**

Fabric = ormolou  brass  tin plated pewter  gilt tin   
 iron  *Frog's of 3* silvered tin  enamelled  other ..... Sample Ret.

**Grip**

Fabric = ormolou  brass  iron  *x3* Sample Ret.

**Design**

swag of rose  horseshoe  cherub's head  *(4) 5* plain

other .....

**Grip bolts**

**Corner bolts**  **Type =** gilt brass  brass  iron

other ..... Sample Ret.

**Lid motifs**

other ..... Sample Ret.

**Escutcheons**

other ..... Sample Ret.

**Upholstery**

*studs*  ~~nails~~  brass  gilt brass  silvered brass  iron  enamelled   
 other ..... *1 x 8 = 3 studs.* Sample Ret.

**Fixings**

panel nails  screws  hinges  lace  Sample Ret.

**Timber type**

..... Sample Ret.

**Interpretation / Comments**

.....  
 .....

SITE <b>OUR 00</b>		COFFIN RECORD SHEET	CONTEXT NO. <b>572</b>
Trench:	Additional sheets:	Treatment: <b>Bones collected</b>	
Site sub-div: <b>NC</b>	Grave fills: <b>-</b>		
Plan no: <b>3</b>	Grave cut: <b>-</b>	Finds None	
Section no:	Skeleton: <b>S73 572</b>	Breastplate Grip	
Co-ordinates:	Matrix location: <b>572</b> <b>573</b>	Hinge Bracket	
Levels	Preservation:	Fixing nails Shroud pins	
Slide No.	Neg No:	Fabric Other finds	

Description **E-W Adult - No skull.**

Discussion

Shape, dimensions and distinguishing characteristics

LID

HEAD

BASE

Recorder: <b>D. Hill</b>	Date: <b>9.10.00</b>	Initials:
--------------------------	----------------------	-----------

# Coffin Recording Sheet

Site Code

Context

**Outer Coffin**

Sample Ret.

OLR00

S72

Recording Date ..... 16/2/01 .....

Associated Numbers .....

Condition .....

Dep. Plate

Legible

Inscription

Fabric lead  ormolou  brass  tin plated pewter  gilt tin   
 iron  silvered tin  enamelled  other ..... Sample Ret.

**Shape of dep. plate**

square  rectangle  shield  tapered  lozenge   
 cartouche  oval  other .....

**Upholstery**

colour ..... shoddy  velvet  other ..... Sample Ret.

**Construction**

butt joint  mitred  pitched  other .....

**Grip plate**

Fabric = ormolou  brass  tin plated pewter  gilt tin   
 iron  silvered tin  enamelled  other ..... Sample Ret.   
*frag on rev. of grip-wood*

**Grip**

Fabric = ormolou  brass  iron  x1 Sample Ret.

**Design**

swag of rose  horseshoe  cherub's head  plain   
*too conc. to id.*

other .....

**Grip bolts**

**Corner bolts**  Type = gilt brass  brass  iron

other ..... Sample Ret.

**Lid motifs**

other ..... Sample Ret.

**Escutcheons**

other ..... Sample Ret.

**Upholstery nails**

brass  gilt brass  silvered brass  iron  enamelled

other ..... Sample Ret.

**Fixings**

panel nails  screws  hinges  lace  Sample Ret.

**Timber type**

..... Sample Ret.

**Interpretation / Comments**

.....  
 .....

SITE <i>02K00</i>		COFFIN RECORD SHEET	CONTEXT NO. <i>573</i>
Trench:	Additional sheets:	Treatment: <i>Bones collected.</i>	
Site sub-div: <i>NC</i>	Grave fills <i>—</i>		
Plan no: <i>3</i>	Grave cut: <i>—</i>	Finds None	
Section no:	Skeleton: <i>573</i>	Breastplate Grip	
Co-ordinates:	Matrix location: <i>572</i> <i>573</i>	Hinge Bracket	
Levels	Preservation:	Fixing nails Shroud pins	
Slide No.	Neg No:	Fabric Other finds	

Description *E-W Adult burial.*

Discussion

Shape, dimensions and distinguishing characteristics

LID

HEAD

BASE

Recorder: <i>D. Hamm</i>	Date: <i>9-10-00.</i>	Initials:
--------------------------	-----------------------	-----------

# Coffin Recording Sheet

Site Code

Context

**Outer Coffin**

Sample Ret.

01200

573

Recording Date ..... 16/2/01 .....

Associated Numbers .....

Condition .....

Dep. Plate

Légible

Inscription

Fabric lead  ormolou  brass  tin plated pewter  gilt tin   
 iron  silvered tin  enamelled  other ..... Sample Ret.

**Shape of dep. plate**

square  rectangle  shield  tapered  lozenge   
 cartouche  oval  other .....

**Upholstery**

colour ..... shoddy  velvet  other ..... Sample Ret.

**Construction**

butt joint  mitred  pitched  other .....

**Grip plate**

Fabric = ormolou  brass  tin plated pewter  gilt tin   
 iron  *Feep on rev. of grip - unid.* silvered tin  enamelled  other ..... Sample Ret.

**Grip**

Fabric = ormolou  brass  iron  *x1* Sample Ret.

**Design**

swag of rose  horseshoe  cherub's head  *(36)* plain

other .....

**Grip bolts**

**Corner bolts**  Type = gilt brass  brass  iron

other ..... Sample Ret.

**Lid motifs**

other ..... Sample Ret.

**Escutcheons**

other ..... Sample Ret.

**Upholstery nails**

brass  gilt brass  silvered brass  iron  enamelled

other ..... Sample Ret.

**Fixings**

panel nails  screws  hinges  lace  Sample Ret.

**Timber type**

..... Sample Ret.

**Interpretation / Comments**

.....  
 .....

SITE <i>OLR 00</i>		COFFIN RECORD SHEET	CONTEXT NO. <i>574</i>
Trench:	Additional sheets:	Treatment: <i>Bones collected.</i>	
Site sub-div: <i>NC</i>	Grave fills <i>/</i>		
Plan no: <i>3</i>	Grave cut: <i>/</i>	Finds None	
Section no:	Skeleton: <i>574</i>	Breastplate Grip	
Co-ordinates:	Matrix location: <i>573</i> <i>574</i>	Hinge Bracket	
Levels	Preservation: <i>GOOD</i>	Fixing nails Shroud pins	
Slide No.	Neg No:	Fabric Other finds	
Description <i>E-W Adult burial.</i>			
Discussion			
Shape, dimensions and distinguishing characteristics			
LID			
HEAD			
BASE			
Recorder: <i>D. Hall</i>	Date: <i>9.10.00</i>	Initials:	

**Outer Coffin**

Sample Ret.

Site Code

Context

Recording Date ..... *21/2/01* .....

*OLR00*

*574*

Associated Numbers .....

Condition .....

Dep. Plate

Legible

Inscription

Fabric lead  ormolou  brass  tin plated pewter  gilt tin   
 iron  silvered tin  enamelled  other ..... Sample Ret.

**Shape of dep. plate**

square  rectangle  shield  tapered  lozenge   
 cartouche  oval  other .....

**Upholstery**

colour ..... shoddy  velvet  other ..... Sample Ret.

**Construction**

butt joint  mitred  pitched  other .....

**Grip plate**

Fabric = ormolou  brass  tin plated pewter  gilt tin   
*pieces of cartouche on rev. of grip, not enough to id.*  
 iron  silvered tin  enamelled  other ..... Sample Ret.   
*black.*

**Grip**

Fabric = ormolou  brass  iron  *1 x* Sample Ret.

**Design**

swag of rose  horseshoe  cherub's head  *3e* plain

other .....

**Grip bolts**

**Corner bolts**  Type = gilt brass  brass  iron

other ..... Sample Ret.

**Lid motifs**

other ..... Sample Ret.

**Escutcheons**

other ..... Sample Ret.

**Upholstery**

*studs*  
 brass  gilt brass  silvered brass  iron  enamelled   
*5 pieces 2x oooooo/x 8 8 / 1x oooooo / 1x oooooo*  
 other .....

**Fixings**

panel nails  screws  hinges  lace  Sample Ret.

**Timber type**

Sample Ret.

**Interpretation / Comments**

.....  
 .....



SITE	COFFIN RECORD SHEET	CONTEXT NO.
02L00	Additional sheets:	575
Trench:	Grave fills	Treatment: BONE COLLECTED
Site sub-div: NC	Grave cut:	Finds None
Plan no: 3	Skeleton: 575	Breastplate Grip
Section no:	Matrix location: 575 576	Hinge Bracket
Co-ordinates:	Preservation: Good	Fixing nails Shroud pins
Levels	Neg No:	Fabric Other finds
Slide No.	Description E-W Adult	
Discussion		
Shape, dimensions and distinguishing characteristics		
LID           HEAD           BASE		
Recorder: [Signature]	Date: 9/10/00	Initials:

# Coffin Recording Sheet

Site Code

Context

OLR00

575

**Outer Coffin**

Sample Ret.

Recording Date ..... 16/2/01 .....

Associated Numbers .....

Condition .....

Dep. Plate

Legible

Inscription

Fabric lead       ormolou       brass       tin plated pewter       gilt tin   
 iron       silvered tin       enamelled       other .....      Sample Ret.

**Shape of dep. plate**

square       rectangle       shield       tapered       lozenge   
 cartouche       oval       other .....

**Upholstery**

colour .....      shoddy       velvet       other .....      Sample Ret.

**Construction**

butt joint       mitred       pitched       other .....

**Grip plate**

Fabric = ormolou       brass       tin plated pewter       gilt tin   
*feags on rev of grip-wood*  
 iron       silvered tin       enamelled       other .....      Sample Ret.

**Grip**

Fabric = ormolou       brass       iron  x 3      Sample Ret.

**Design**

swag of rose       horseshoe       cherub's head       (3b) / 5      plain

other .....

**Grip bolts**

**Corner bolts**       Type =      gilt brass       brass       iron

other .....      Sample Ret.

**Lid motifs**

other .....      Sample Ret.

**Escutcheons**

other .....      Sample Ret.

**Upholstery nails**

brass       gilt brass       silvered brass       iron       enamelled

other .....      Sample Ret.

**Fixings**

panel nails       screws       hinges       lace       Sample Ret.

**Timber type** .....

Sample Ret.

**Interpretation / Comments**

.....  
 .....

SITE 0LR60	COFFIN RECORD SHEET	CONTEXT NO. 576
Trench:	Additional sheets:	Treatment:
Site sub-div: WL	Grave fills	Bones collected
Plan no: 3	Grave cut:	Finds None
Section no:	Skeleton: 576	Breastplate Grip
Co-ordinates:	Matrix location: 575 576	Hinge Bracket
Levels	Preservation: GOOD	Fixing nails Shroud pins
Slide No.	Neg No:	Fabric Other finds
Description E-W skull		
Discussion Extra bones; Mandible, Male, adult Dental age 30. 1st Mc's Distal R. ulna } possibly 575 or charnel		
Shape, dimensions and distinguishing characteristics  LID  HEAD  BASE		
Recorder:	Date: 9/10/00	Initials:

SITE OLR 00	COFFIN RECORD SHEET	CONTEXT NO. 577
Trench:	Additional sheets:	Treatment: BONES COLLECTED
Site sub-div: NC	Grave fills	
Plan no: 3	Grave cut:	Finds None
Section no:	Skeleton: 577	Breastplate Grip
Co-ordinates:	Matrix location: <del>577</del> <del>578</del>	Hinge Bracket
Levels	Preservation:	Fixing nails Shroud pins
Slide No.	Neg No:	Fabric Other finds
Description E-W. WOOD BURIAL		
Discussion		
Shape, dimensions and distinguishing characteristics		
LID		
HEAD		
BASE		
Recorder: JBM	Date: 10/10/00	Initials:

SITE	COFFIN RECORD SHEET	CONTEXT NO.
OLR00	Additional sheets:	578 Treatment: BONES COLLECTED
Trench:	Grave fills	
Site sub-div: NC	Grave cut:	Finds
Plan no:	Skeleton: 578	None
Section no:	Matrix location: <del>578</del> 578	Breastplate
Co-ordinates:	Preservation:	Grip
Levels	Neg No:	Hinge
Slide No.	Description	Bracket
EDIN ADULT BURIAL		
Discussion		
Shape, dimensions and distinguishing characteristics		
LID		
HEAD		
BASE		
Recorder: JBM	Date: 10/10/00	Initials:

**Outer Coffin**

Sample Ret.

Site Code

Context

Recording Date ..... 19/2/01 .....

Oh200

578

Associated Numbers .....

Condition .....

Dep. Plate

Legible

Inscription

Fabric lead  ormolou  brass  tin plated pewter  gilt tin   
 iron  silvered tin  enamelled  other ..... Sample Ret.

**Shape of dep. plate**

square  rectangle  shield  tapered  lozenge   
 cartouche  oval  other .....

**Upholstery**

colour ..... shoddy  velvet  other ..... Sample Ret.

**Construction**

butt joint  mitred  pitched  other .....

**Grip plate**

Fabric = ormolou  brass  tin plated pewter  gilt tin   
 iron  *flugs on lev on grip-wood.* silvered tin  enamelled  other ..... Sample Ret.

**Grip**

Fabric = ormolou  brass  iron  <sup>4x2</sup> Sample Ret.

**Design**

swag of rose  horseshoe  cherub's head  <sup>36</sup> plain

other .....

**Grip bolts**

**Corner bolts**  Type = gilt brass  brass  iron

other ..... Sample Ret.

**Lid motifs**

other ..... Sample Ret.

**Escutcheons**

other ..... Sample Ret.

**Upholstery nails**

brass  gilt brass  silvered brass  iron  enamelled

other ..... Sample Ret.

**Fixings**

panel nails  screws  hinges  lace  Sample Ret.

**Timber type**

..... Sample Ret.

**Interpretation / Comments**

.....  
 .....

SITE	COFFIN RECORD SHEET	CONTEXT NO.
OLR00	Additional sheets:	579
Trench:	Grave fills	Treatment: BONE COLLECTED
Site sub-div: NC	Grave cut:	Finds
Plan no: 3	Skeleton:	None
Section no:	579	Breastplate
Co-ordinates:	Matrix location: 579 580	Grip
Levels	Preservation: GOOD	Hinge
Slide No.	Neg No:	Bracket
Description	6-w Adult possibly mixed with 580 & 581	Fixing nails
Discussion		Shroud pins
Shape, dimensions and distinguishing characteristics		Fabric
LID	Extra Bones: L Radius + Ulna	Other finds
HEAD	L+R Patella	
BASE	L+R Tibiae L+R Fibulae	
	All tarsals apart from R Talus	
	L+R 1st Mt	
	R 2nd Mt	
	R+L 3rd Mt	
	L 5th Mt	
	1	
Recorder: JH	Date: 10/10/00	1 maybe 2 individuals - Adults 580 or/and 581
Recorder:	Date:	Initials:

# Coffin Recording Sheet

**Outer Coffin**

Sample Ret.

Site Code

Context

Recording Date ..... 22/2/01

OH200

579

Associated Numbers .....

Condition .....

Dep. Plate

Legible

Inscription

Fabric lead  ormolou  brass  tin plated pewter  gilt tin   
 iron  silvered tin  enamelled  other ..... Sample Ret.

**Shape of dep. plate**

square  rectangle  shield  tapered  lozenge   
 cartouche  oval  other .....

**Upholstery**

colour ..... shoddy  velvet  other ..... Sample Ret.

**Construction**

butt joint  mitred  pitched  other .....

**Grip plate**

Fabric = ormolou  brass  tin plated pewter  gilt tin   
*Progs on rev of grip-wood.*  
 iron  silvered tin  enamelled  other ..... Sample Ret.

**Grip**

Fabric = ormolou  brass  iron  <sup>x1</sup> Sample Ret.

**Design**

swag of rose  horseshoe  cherub's head  *too cone. to id* plain

other .....

**Grip bolts**

**Corner bolts**  Type = gilt brass  brass  iron

other ..... Sample Ret.

**Lid motifs**

other ..... Sample Ret.

**Escutcheons**

other ..... Sample Ret.

**Upholstery nails**

brass  gilt brass  silvered brass  iron  enamelled

other ..... Sample Ret.

**Fixings**

panel nails  screws  hinges  lace  Sample Ret.

**Timber type**

..... Sample Ret.

**Interpretation / Comments**

.....  
 .....



SITE	COFFIN RECORD SHEET	CONTEXT NO.
04100		580
Trench:	Additional sheets:	Treatment:
Site sub-div: NC	Grave fills	BONE COLLECTS!
Plan no: 3	Grave cut:	Finds
Section no:	Skeleton: 580	None
Co-ordinates:	Matrix location: 579 580	Breastplate
Levels	Preservation: 581 GOOD	Grip
Slide No.	Neg No:	Hinge
Description	6-w Adult poss mixed with 581 & 579	
Discussion		
Shape, dimensions and distinguishing characteristics		
LID		
HEAD		
BASE		
Recorder: JK	Date: 10/10/02	Initials:

SITE <i>02100</i>		COFFIN RECORD SHEET		CONTEXT NO. <i>581</i>	
Trench:		Additional sheets:		Treatment: <i>BONE COLLECTED</i>	
Site sub-div: <i>NC</i>		Grave fills			
Plan no: <i>3</i>		Grave cut:		Finds	
Section no:		Skeleton: <i>581</i>		None	
Co-ordinates:		Matrix location: <i>580</i> <i>1</i> <i>581</i>		Breastplate	
Levels		Preservation: <i>BONE GOOD</i>		Grip	
Slide No.		Neg. No:		Hinge	
Description <i>6-W BURIAL POSS MIXED WITH 580.</i>				Bracket	
Discussion				Fixing nails	
Shape, dimensions and distinguishing characteristics				Shroud pins	
LID				Fabric	
HEAD				Other finds	
BASE					
Recorder: <i>JLH</i>		Date: <i>10/10/00</i>		Initials:	

# Coffin Recording Sheet

Site Code

Context

06200

581

**Outer Coffin**

Sample Ret.

Recording Date ..... 19/2/01 .....

Associated Numbers .....

Condition .....

Dep. Plate

Legible

Inscription

Fabric lead  ormolou  brass  tin plated pewter  gilt tin   
 iron  silvered tin  enamelled  other ..... Sample Ret.

**Shape of dep. plate**

square  rectangle  shield  tapered  lozenge   
 cartouche  oval  other .....

**Upholstery**

colour ..... shoddy  velvet  other ..... Sample Ret.

**Construction**

butt joint  mitred  pitched  other .....

**Grip plate**

Fabric = ormolou  brass  tin plated pewter  gilt tin   
 iron  silvered tin  enamelled  other ..... Sample Ret.   
*frag of S on rev. of grip*

**Grip**

Fabric = ormolou  brass  iron  Sample Ret.   
*x1*

**Design**

swag of rose  horseshoe  cherub's head  plain   
*22802*

other .....

**Grip bolts**

**Corner bolts**  Type = gilt brass  brass  iron

other ..... Sample Ret.

**Lid motifs**

other ..... Sample Ret.

**Escutcheons**

other ..... Sample Ret.

**Upholstery nails**

brass  gilt brass  silvered brass  iron  enamelled

other ..... Sample Ret.

**Fixings**

panel nails  screws  hinges  lace  Sample Ret.

**Timber type**

Sample Ret.

**Interpretation / Comments**

.....  
 .....

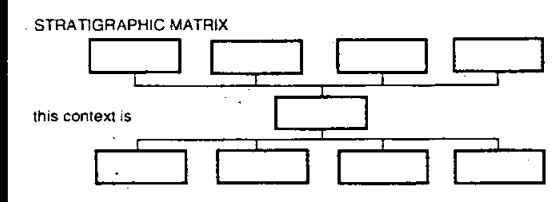
SITE <i>OLR 00</i>	<b>CONTEXT RECORD</b>	Context No. <i>582</i>
	Additional Sheets:	Type <i>STRUC</i>
Trench	Context Type: <i>Deposit / Cut / Structure</i>	Check Lists:
Site sub-div <i>NC</i>	Overlain by:	DEPOSIT: 1.compaction 2.colour 3.composition 4.inclusions 5.thickness 6.extent 7.comments 8.method & conditions
Structure No.	Abutted by:	
Plan No.  <i>3</i>	Cut by:	CUT: 1.shape in plan 2.base/sides/top profile 3.dimension and depth 4.sketch 5.truncation 6.fill nos 7.other comments
Section No.	Filled by:	
Co-Ordinates	Same as:	MASONRY: 1.materials 2.size of bricks etc 3.finish of stones 4.coursing/bond 5.form 6.faces 7.bond 8.dimensions as found 9.other comments
Level	Part of:	
Slide No.	Consists of:	
Neg No.	Overlies:	
Matrix location	Butts:	
	Cuts:	
	Fill of:	
	Relationships uncertain	
Description (See check lists):		STRATIGRAPHIC MATRIX 
(1) <i>Brick, stone, mortar, rubble</i>		
Interpretation/Discussion:		
Attempted bracing of church to prevent further subsidence.		
Finds (tick): None <input type="checkbox"/> Pot <input type="checkbox"/> Bone <input type="checkbox"/> Flint <input type="checkbox"/> Stone <input type="checkbox"/> Burnt stone <input type="checkbox"/> Glass <input type="checkbox"/> Metal <input type="checkbox"/> CBM <input type="checkbox"/> Wood <input type="checkbox"/> Leather <input type="checkbox"/>		
ΔSmall Finds	Recorder <i>DH</i>	
◇Samples	Date <i>10.10.00</i>	
ΔBuilding Materials	Initials	

SITE <b>OLR 00</b>		CONTEXT RECORD		Context No. <b>583</b>
Trench		Additional Sheets:		Type <b>STRUC</b>
Site sub-div <b>NC</b>	Context Type: <b>Deposit / Cut / Structure</b>	Check Lists: <input type="checkbox"/>		
Structure No.	Overlain by:	DEPOSIT:		
Plan No. <b>3</b>	Abuted by:	1.compaction 2.colour 3.composition 4.inclusions 5.thickness 6.extent 7.comments 8.method & conditions		
Section No.	Cut by:	CUT:		
Co-Ordinates	Filled by:	1.shape in plan 2.base/sides/top profile 3.dimension and depth 4.sketch 5.truncation 6.fill nos 7.other comments		
Level	Same as:	MASONRY:		
Slide No.	Part of:	1.materials 2.size of bricks etc 3.finish of stones 4.coursing/bond 5.form 6.faces 7.bond 8.dimensions as found 9.other comments		
Neg No.	Consists of:			
Matrix location	Overlies:			
Description (See check lists):		STRATIGRAPHIC MATRIX		
<b>① Brick, stone, mortar, rubble.</b>				
Interpretation/Discussion:				
<b>Attempted buttressing of church to prevent further subsidence. Built in a 'step' fashion, from all different materials</b>				
Finds (tick): None <input type="checkbox"/> Pot <input type="checkbox"/> Bone <input type="checkbox"/> Flint <input type="checkbox"/> Stone <input type="checkbox"/> Burnt stone <input type="checkbox"/> Glass <input type="checkbox"/> Metal <input type="checkbox"/> CBM <input type="checkbox"/> Wood <input type="checkbox"/> Leather <input type="checkbox"/>				
ΔSmall Finds				Recorder <b>JK</b>
◇Samples				Date <del>10/10/00</del> 10/10/00
△Building Materials				Initials

SITE <i>OLR 50</i>		COFFIN RECORD SHEET		CONTEXT NO. <i>584</i>	
Trench:		Additional sheets:		Treatment: <i>Bones collected.</i>	
Site sub-div: <i>NC</i>		Grave fills: <i>-</i>			
Plan no: <i>3</i>		Grave cut: <i>-</i>		Finds None	
Section no:		Skeleton: <i>584</i>		Breastplate Grip	
Co-ordinates:		Matrix location: <i>584</i> <i>585</i>		Hinge Bracket	
Levels		Preservation: <i>GOOD.</i>		Fixing nails Shroud pins	
Slide No.		Neg. No:		Fabric Other finds	
Description <i>E-W Adult burial 0/lies 585</i>					
Discussion					
Shape, dimensions and distinguishing characteristics					
LID					
HEAD					
BASE					
Recorder: <i>D. Hall</i>		Date: <i>10.10.50.</i>		Initials:	

Site Code

Context

**Outer Coffin**

Sample Ret.

OL200

584

Recording Date ..... 19/2/01

Associated Numbers .....

Condition .....

Dep. Plate

Legible

Inscription

Fabric lead  ormolou  brass  tin plated pewter  gilt tin   
 iron  silvered tin  enamelled  other ..... Sample Ret.

**Shape of dep. plate**

square  rectangle  shield  tapered  lozenge   
 cartouche  oval  other .....

**Upholstery**

colour ..... shoddy  velvet  other ..... Sample Ret.

**Construction**

butt joint  mitred  pitched  other .....

**Grip plate**

Fabric = ormolou  brass  tin plated pewter  gilt tin   
*Fabric on lev of grip - unid*  
 iron  silvered tin  enamelled  other ..... Sample Ret.

**Grip**

Fabric = ormolou  brass  iron  *x5* Sample Ret.

**Design**

swag of rose  horseshoe  cherub's head  plain   
*3 x lgn ←→ 0.165 ↓ 0.07 / 2 x oval ←→ 0.14 ↓ 0.055*

**Grip bolts**

**Corner bolts**  Type = gilt brass  brass  iron

other ..... Sample Ret.

**Lid motifs**

other ..... Sample Ret.

**Escutcheons**

other ..... Sample Ret.

**Upholstery nails**

brass  gilt brass  silvered brass  iron  enamelled

other ..... Sample Ret.

**Fixings**

panel nails  screws  hinges  lace  Sample Ret.

**Timber type** .....

Sample Ret.

**Interpretation / Comments**

.....  
 .....

SITE		COFFIN RECORD SHEET		CONTEXT NO.	
OLR 00				585	
Trench:		Additional sheets:		Treatment:	
Site sub-div: NC		Grave fills: /		Bones collected.	
Plan no: 3		Grave cut: /		Finds	
Section no:		Skeleton: 585		None	
Co-ordinates:		Matrix location: 584 585 586		Breastplate	
Levels		Preservation:		Grip	
Slide No.		Neg No:		Hinge	
Description		E-W Adult o/lies 586, u/lies 586		Bracket	
Discussion				Fixing nails	
Shape, dimensions and distinguishing characteristics				Shroud pins	
LID				Fabric	
HEAD				Other finds	
BASE					
Recorder: D. Azu		Date: 10.10.00		Initials:	



# Coffin Recording Sheet

Site Code

Context

**Outer Coffin**

Sample Ret.

04200

585

Recording Date ..... 16/2/01 .....

Associated Numbers .....

Condition .....

Dep. Plate

Legible

Inscription

Fabric lead  ormolou  brass  tin plated pewter  gilt tin   
 iron  silvered tin  enamelled  other ..... Sample Ret.

**Shape of dep. plate**

square  rectangle  shield  tapered  lozenge   
 cartouche  oval  other .....

**Upholstery**

colour ..... shoddy  velvet  other ..... Sample Ret.

**Construction**

butt joint  mitred  pitched  other .....

**Grip plate**

Fabric = ormolou  brass  tin plated pewter  gilt tin   
*flaps on rev of grip-und.*  
 iron  silvered tin  enamelled  other ..... Sample Ret.

**Grip**

Fabric = ormolou  brass  iron  <sup>x 4</sup> Sample Ret.   
 ①'s.

**Design**

swag of rose  horseshoe  cherub's head  plain

other .....

**Grip bolts**

**Corner bolts**  Type = gilt brass  brass  iron

other ..... Sample Ret.

**Lid motifs**

other ..... Sample Ret.

**Escutcheons**

other ..... Sample Ret.

**Upholstery nails**

brass  gilt brass  silvered brass  iron  enamelled

other ..... Sample Ret.

**Fixings**

panel nails  screws  hinges  lace  Sample Ret.

**Timber type**

..... Sample Ret.

**Interpretation / Comments**

.....  
 .....

SITE <i>ORR 00</i>	COFFIN RECORD SHEET	CONTEXT NO. <i>586</i>
Trench:	Additional sheets:	Treatment:
Site sub-div: <i>NC</i>	Grave fills <i>/</i>	<i>Bones collected.</i>
Plan no: <i>3</i>	Grave cut: <i>/</i>	Finds None
Section no:	Skeleton: <i>586</i>	Breastplate Grip
Co-ordinates:	Matrix location: <i>585</i> <i>586</i> <i>587</i>	Hinge Bracket
Levels	Preservation: <i>wood</i>	Fixing nails Shroud pins
Slide No.	Neg No:	Fabric Other finds
Description <i>E-W Adult urns 585, others 587.</i>		
Discussion		
Shape, dimensions and distinguishing characteristics		
Recorder: <i>D. Hall</i> Date: <i>10.10.00</i> Initials:		

**Outer Coffin**

Sample Ret.

Site Code

Context

Recording Date ..... 21/2/01 .....

Oh200

586

Associated Numbers .....

Condition .....

Dep. Plate

Legible

Inscription

Fabric lead  ormolou  brass  tin plated pewter  gilt tin   
 iron  silvered tin  enamelled  other ..... Sample Ret.

**Shape of dep. plate**

square  rectangle  shield  tapered  lozenge   
 cartouche  oval  other .....

**Upholstery**

colour ..... shoddy  velvet  other ..... Sample Ret.

**Construction**

butt joint  mitred  pitched  other .....

**Grip plate**

Fabric = ormolou  brass  tin plated pewter  gilt tin   
 iron  silvered tin  enamelled  other ..... Sample Ret.   
*Feas on rev of grip - unid.*

**Grip**

Fabric = ormolou  brass  iron  <sup>x2</sup> <sub>①5</sub> Sample Ret.

**Design**

swag of rose  horseshoe  cherub's head  plain

other .....

**Grip bolts**

**Corner bolts**  Type = gilt brass  brass  iron

other ..... Sample Ret.

**Lid motifs**

other ..... Sample Ret.

**Escutcheons**

other ..... Sample Ret.

**Upholstery**

<sup>shudo</sup>  brass  gilt brass  silvered brass  iron  enamelled   
 other ..... 1x0 / 1x00 ..... Sample Ret.

**Fixings**

panel nails  screws  hinges  lace  Sample Ret.

**Timber type**

..... Sample Ret.

**Interpretation / Comments**

.....  
 .....

SITE	COFFIN RECORD SHEET	CONTEXT NO.
OLR 00	Additional sheets:	587 Treatment: Bones collected.
Trench:	Grave fills: —	
Site sub-div: NC	Grave cut: —	Finds None
Plan no: 3	Skeleton: 587	Breastplate Grip
Section no:	Matrix location: 586 587 588	Hinge Bracket
Co-ordinates:	Preservation: Good.	Fixing nails Shroud pins
Levels	Neg No:	Fabric Other finds
Slide No.		
<b>Description</b> E-W Adult. Head possibly from 588? - Bit of a jumble  <b>Discussion</b>		
<b>Shape, dimensions and distinguishing characteristics</b>  LID  HEAD  BASE		
Recorder: D. H. M.	Date: 10.10.00	Initials:

Site Code

Context

**Outer Coffin**

Sample Ret.

OLR00

587

Recording Date ..... 16/2/01 .....

Associated Numbers .....

Condition .....

Dep. Plate

Legible

Inscription

Fabric lead  ormolou  brass  tin plated pewter  gilt tin   
 iron  silvered tin  enamelled  other ..... Sample Ret.

**Shape of dep. plate .**

square  rectangle  shield  tapered  lozenge   
 cartouche  oval  other .....

**Upholstery**

colour ..... shoddy  velvet  other ..... Sample Ret.

**Construction** butt joint  mitred  pitched  other .....

**Grip plate**  Fabric = ormolou  brass  tin plated pewter  gilt tin   
 iron  silvered tin  enamelled  other ..... Sample Ret.   
*Frogs on rev of grip-wood.*

**Grip**  Fabric = ormolou  brass  iron  x1 Sample Ret.

**Design** swag of rose  horseshoe  cherub's head  ① plain   
 other .....

**Grip bolts**  **Corner bolts**  **Type =** gilt brass  brass  iron   
 other ..... Sample Ret.

**Lid motifs**  other .....

**Escutcheons**  other .....

**Upholstery nails**  brass  gilt brass  silvered brass  iron  enamelled   
 other ..... Sample Ret.

**Fixings**  panel nails  screws  hinges  lace  Sample Ret.

**Timber type** ..... Sample Ret.

**Interpretation / Comments**

.....  
 .....

SITE <i>CLR 50</i>		COFFIN RECORD SHEET		CONTEXT NO. <i>588</i>	
Trench:		Additional sheets:		Treatment: <i>Bones collected</i>	
Site sub-div: <i>NC</i>		Grave fills: <i>—</i>		Finds None	
Plan no: <i>3</i>		Grave cut: <i>—</i>			
Section no:		Skeleton: <i>588</i>		Breastplate	
Co-ordinates:		Matrix location: <i>587</i> <i>588</i> <i>589</i>		Grip	
Levels		Preservation: <i>Good</i>		Hinge	
Slide No.:		Neg No:		Bracket	
				Fixing nails	
				Shroud pins	
				Fabric	
				Other finds	
<p><b>Description</b> <i>E-W Adult. Head possibly 587 or 589? Jumbled up.</i></p> <p><i>Additional Mandible, cervical + thoracic Vertebrae, sternum + clavicles identified during osteological analysis</i></p> <p><b>Discussion</b> <i>→ 1310</i></p>					
<p><b>Shape, dimensions and distinguishing characteristics</b></p> <p>LID</p> <p>HEAD</p> <p>BASE</p>					
Recorder: <i>D. Hall</i>		Date: <i>10.10.00.</i>		Initials:	

SITE	COFFIN RECORD SHEET	CONTEXT NO.
02R 00		589
Trench:	Additional sheets:	Treatment: Bones collected.
Site sub-div: NC	Grave fills /	
Plan no: 3	Grave cut: /	Finds
Section no:	Skeleton: 589	None Breastplate Grip
Co-ordinates:	Matrix location: 588 589	Hinge Bracket
Levels	Preservation: Fair/Good.	Fixing nails Shroud pins
Slide No.	Neg No:	Fabric Other finds
<p>Description: E-W Adult buried of/in by 588.</p> <p>Discussion:</p>		
<p>Shape, dimensions and distinguishing characteristics</p> <p>LID</p> <p>HEAD</p> <p>BASE</p>		
Recorder: D. HAZM	Date: <del>11.10.00</del> 11.10.00.	Initials:

SITE	COFFIN RECORD SHEET	CONTEXT NO.
OLR 00	Additional sheets:	590 Treatment: Bones collected.
Trench:	Grave fills /	
Site sub-div: NC	Grave cut: /	Finds
Plan no: 3	Skeleton: 590	None
Section no:	Matrix location: 590 591	Breastplate Grip
Co-ordinates:	Preservation: 6000.	Hinge Bracket
Levels	Neg No:	Fixing nails Shroud pins
Slide No.	Description	Fabric Other finds
<p data-bbox="279 920 705 965">E-W Adult burial.</p> <p data-bbox="147 1093 260 1120">Discussion</p>		
<p data-bbox="147 1272 689 1299">Shape, dimensions and distinguishing characteristics</p> <p data-bbox="147 1417 194 1444">LID</p> <p data-bbox="147 1619 221 1646">HEAD</p> <p data-bbox="147 1821 216 1848">BASE</p>		
Recorder: J. Hall	Date: 11.10.00.	Initials:



**Outer Coffin**

Sample Ret.

Site Code

Context

Recording Date ..... 21/2/01 .....

OLR00

590

Associated Numbers .....

Condition .....

Dep. Plate

Legible

Inscription

Fabric lead  ormolou  brass  tin plated pewter  gilt tin   
 iron  silvered tin  enamelled  other ..... Sample Ret.

**Shape of dep. plate**

square  rectangle  shield  tapered  lozenge   
 cartouche  oval  other .....

**Upholstery**

colour ..... shoddy  velvet  other ..... Sample Ret.

**Construction**

butt joint  mitred  pitched  other .....

**Grip plate**

Fabric = ormolou  brass  tin plated pewter  gilt tin   
 iron  *frag on rev of grip - unid* silvered tin  enamelled  other ..... Sample Ret.

**Grip**

Fabric = ormolou  brass  iron  *x 3* Sample Ret.

**Design**

swag of rose  horseshoe  cherub's head  *Ⓟ* plain

other .....

**Grip bolts**

**Corner bolts**  Type = gilt brass  brass  iron

other ..... Sample Ret.

**Lid motifs**

other ..... Sample Ret.

**Escutcheons**

other ..... Sample Ret.

**Upholstery**

*studs*  brass  gilt brass  silvered brass  iron  enamelled

other ..... Sample Ret.

**Fixings**

panel nails  screws  hinges  lace  Sample Ret.

**Timber type**

Sample Ret.

**Interpretation / Comments**

.....  
 .....

SITE	COFFIN RECORD SHEET		CONTEXT NO. 591
Trench:	Additional sheets: 4E5 x 1		Treatment: Bones collected.
Site sub-div: NC	Grave fills /		
Plan no: 3	Grave cut: /		Finds None
Section no:	Skeleton: 591		Breastplate Grip
Co-ordinates:	Matrix location: <del>S77</del> <del>S78</del> S70 S91 S93		Hinge Bracket
Levels	Preservation: Good.		Fixing nails Shroud pins
Slide No.	Neg No:		Fabric Other finds
Description E-W Adult burial.			
Discussion			
Shape, dimensions and distinguishing characteristics			
LID			
HEAD			
BASE			
Recorder: D. Hall	Date: 11.10.00.		Initials:

Site Code

Context

**Outer Coffin**

Sample Ret.

OLR00

591

Recording Date ..... 11/10

Associated Numbers .....

Condition .....

Dep. Plate

Legible

Inscription

Fabric lead  ormolou  brass  tin plated pewter  gilt tin   
 iron  silvered tin  enamelled  other ..... Sample Ret.

**Shape of dep. plate**

square  rectangle  shield  tapered  lozenge   
 cartouche  oval  other .....

**Upholstery**

colour ..... shoddy  velvet  other ..... Sample Ret.

**Construction**

butt joint  mitred  pitched  other .....

**Grip plate**

Fabric = ormolou  brass  tin plated pewter  gilt tin

iron  silvered tin  enamelled  other ..... Sample Ret.

*knags on rev of grip*

**Grip**

Fabric = ormolou  brass

**Design**

swag of rose  horseshoe  cherub's head  plain

other .....

*iron  x 2 Sample Ret.   
 conc. - 2 diff sizes - 1x ← 0.13 ↑ 0.05  
 1x ← 0.15 ↓ 0.06  
 side & head/foot? prob. ①'s*

**Grip bolts**

**Corner bolts**  Type = gilt brass  brass  iron

other ..... Sample Ret.

**Lid motifs**

other .....

**Escutcheons**

other .....

**Upholstery nails**

brass  gilt brass  silvered brass  iron  enamelled

other ..... Sample Ret.

**Fixings**

panel nails  screws  hinges  lace  Sample Ret.

**Timber type**

..... Sample Ret.

**Interpretation / Comments**

.....  
 .....

SITE <i>OLR 00.</i>		COFFIN RECORD SHEET	CONTEXT NO. <i>592</i>
Trench:	Additional sheets:	Treatment: <i>Bones collected.</i>	
Site sub-div: <i>NC</i>	Grave fills <i>/</i>		
Plan no: <i>3</i>	Grave cut: <i>/</i>	Finds None	
Section no:	Skeleton: <i>592</i>	Breastplate Grip	
Co-ordinates:	Matrix location: <i>594 (truncated) 592</i>	Hinge Bracket	
Levels	Preservation: <i>FAIR.</i>	Fixing nails Shroud pins	
Slide No.	Neg No:	Fabric Other finds	
Description <i>E-W Adult burial, truncated at waist height by 594.</i>			
Discussion			
Shape, dimensions and distinguishing characteristics			
LID			
HEAD			
BASE			
Recorder: <i>D. H. W.</i>	Date: <i>11.10.00.</i>	Initials:	

SITE <i>02R 00</i>		COFFIN RECORD SHEET	CONTEXT NO. <i>593</i>
Trench:	Additional sheets:	Treatment: <i>Bones collected.</i>	
Site sub-div: <i>NC</i>	Grave fills <i>/</i>		
Plan no: <i>3</i>	Grave cut: <i>/</i>	Finds None	
Section no:	Skeleton: <i>593</i>	Breastplate Grip	
Co-ordinates:	Matrix location: <i>593</i> <i>594</i>	Hinge Bracket	
Levels	Preservation: <i>Good.</i>	Fixing nails Shroud pins	
Slide No.	Neg No:	Fabric Other finds	
Description <i>E-W Adult burial.</i>			
Discussion			
Shape, dimensions and distinguishing characteristics			
LID			
HEAD			
BASE			
Recorder: <del>H. to.</del> <i>D. H. M.</i>	Date: <i>11-10-52</i>	Initials:	

SITE <i>OLR 00</i>		COFFIN RECORD SHEET	CONTEXT NO. <i>594.</i>
Trench:	Additional sheets:	Treatment: <i>Bones collected.</i>	
Site sub-div: <i>NC</i>	Grave fills: <i>/</i>		
Plan no: <i>3</i>	Grave cut: <i>/</i>	Finds None	
Section no:	Skeleton: <i>594</i>	Breastplate Grip	
Co-ordinates:	Matrix location: <i>593</i> <i>1</i> <i>594</i>	Hinge Bracket	
Levels	Preservation: <i>GOOD.</i>	Fixing nails Shroud pins	
Slide No.	Neg No:	Fabric Other finds	
Description <i>E-W Adult Burial.</i>			
Discussion			
Shape, dimensions and distinguishing characteristics			
LID			
HEAD			
BASE			
Recorder: <i>D. Ham</i>	Date: <i>11.10.00.</i>	Initials:	

# Coffin Recording Sheet

Site Code

Context

**Outer Coffin**

Sample Ret.

OLR00

594

Recording Date ..... 16/2/01

Associated Numbers .....

Condition .....

Dep. Plate

Legible

Inscription

Fabric lead  ormolou  brass  tin plated pewter  gilt tin   
 iron  silvered tin  enamelled  other ..... Sample Ret.

**Shape of dep. plate**

square  rectangle  shield  tapered  lozenge   
 cartouche  oval  other .....

**Upholstery**

colour ..... shoddy  velvet  other ..... Sample Ret.

**Construction**

butt joint  mitred  pitched  other .....

Grip plate  Fabric = ormolou  brass  tin plated pewter  gilt tin   
 iron  silvered tin  enamelled  other ..... Sample Ret.

Grip  Fabric = ormolou  brass  iron  X1 Sample Ret.

Design swag of rose  horseshoe  cherub's head  (4) plain   
 other .....

Grip bolts  Corner bolts  Type = gilt brass  brass  iron

other ..... Sample Ret.

Lid motifs  other ..... Sample Ret.

Escutcheons  other ..... Sample Ret.

Upholstery nails  brass  gilt brass  silvered brass  iron  enamelled   
 other ..... Sample Ret.

Fixings  panel nails  screws  hinges  lace  Sample Ret.

Timber type ..... Sample Ret.

**Interpretation / Comments**

.....  
 .....

SITE <u>OLR 00</u>		COFFIN RECORD SHEET	CONTEXT NO. <u>595</u>
Trench:	Additional sheets:	Treatment: <u>BONES COLLECTED</u>	
Site sub-div: <u>NC</u>	Grave fills		
Plan no: <u>3</u>	Grave cut:	Finds None	
Section no:	Skeleton: <u>§</u>	Breastplate Grip	
Co-ordinates:	Matrix location: <u>589</u> <u>595</u>	Hinge Bracket	
Levels	Preservation: <u>GOOD</u>	Fixing nails Shroud pins	
Slide No.	Neg No:	Fabric Other finds :	
Description <u>E-W ADULT BURIAL</u>			
Discussion			
Shape, dimensions and distinguishing characteristics			
LID			
HEAD			
BASE			
Recorder: <u>DM</u>	Date: <u>11/10/00</u>	Initials:	



# Coffin Recording Sheet

**Outer Coffin**

Sample Ret.

Site Code

Context

Recording Date ..... 16/2/01

Ch200

595

Associated Numbers .....

Condition .....

Dep. Plate

Legible

Inscription

Fabric lead  ormolou  brass  tin plated pewter  gilt tin   
iron  silvered tin  enamelled  other ..... Sample Ret.

**Shape of dep. plate**

square  rectangle  shield  tapered  lozenge   
cartouche  oval  other .....

**Upholstery**

colour ..... shoddy  velvet  other ..... Sample Ret.

**Construction**

butt joint  mitred  pitched  other .....

**Grip plate**

Fabric = ormolou  brass  tin plated pewter  gilt tin   
iron  *Person Rev. of grip - unid.* silvered tin  enamelled  other ..... Sample Ret.

**Grip**

Fabric = ormolou  brass  iron  x2 Sample Ret.

**Design**

swag of rose  horseshoe  cherub's head  (20)'s plain

other .....

**Grip bolts**

**Corner bolts**  Type = gilt brass  brass  iron

other ..... Sample Ret.

**Lid motifs**

other ..... Sample Ret.

**Escutcheons**

other ..... Sample Ret.

**Upholstery nails**

brass  gilt brass  silvered brass  iron  enamelled

other ..... Sample Ret.

**Fixings**

panel nails  screws  hinges  lace  Sample Ret.

**Timber type** .....

Sample Ret.

**Interpretation / Comments**

.....  
.....

SITE	COFFIN RECORD SHEET	CONTEXT NO.
OLK 00	Additional sheets: YES X1	596 Treatment: BONES COLLECTED
Trench:	Grave fills	
Site sub-div: NE	Grave cut:	Finds None
Plan no: 3	Skeleton:	Breastplate Grip <del>WOT</del>
Section no:	Matrix location: 596 630	Hinge Bracket
Co-ordinates:	Preservation: 9001	Fixing nails Shroud pins
Levels	Neg No:	Fabric Other finds
Slide No.	Description	
E-W ADULT BURIAL - NO SKULL/UPPER BODY DISTURBED.		
Discussion		
Shape, dimensions and distinguishing characteristics		
LID		
HEAD		
BASE		
Recorder: BM	Date: 11/10/00	Initials:

# Coffin Recording Sheet

Site Code

Context

**Outer Coffin**

Sample Ret.

01200

596

Recording Date ..... 12/2/01 .....

Associated Numbers .....

Condition .....

Dep. Plate

Legible

Inscription

Fabric lead  ormolou  brass  tin plated pewter  gilt tin   
iron  silvered tin  enamelled  other ..... Sample Ret.

**Shape of dep. plate**

square  rectangle  shield  tapered  lozenge   
cartouche  oval  other .....

**Upholstery**

colour ..... shoddy  velvet  other ..... Sample Ret.

**Construction**

butt joint  mitred  pitched  other .....

**Grip plate**

Fabric = ormolou  brass  tin plated pewter  gilt tin   
iron  1 x 228b silvered tin  enamelled  other ..... Sample Ret.

**Grip**

Fabric = ormolou  brass  iron  x2 Sample Ret.

**Design**

swag of rose  horseshoe  cherub's head  228d plain

other .....

**Grip bolts**

**Corner bolts**  Type = gilt brass  brass  iron

other ..... Sample Ret.

**Lid motifs**

other ..... Sample Ret.

**Escutcheons**

other ..... Sample Ret.

**Upholstery nails**

brass  gilt brass  silvered brass  iron  enamelled

other ..... Sample Ret.

**Fixings**

panel nails  screws  hinges  lace  Sample Ret.

**Timber type**

..... Sample Ret.

**Interpretation / Comments**

.....  
.....

db

SITE OLR00	COFFIN RECORD SHEET	CONTEXT NO. 597
Trench: CRYPT	Additional sheets:	Treatment: SILVER LIFTED u DNA TAKEN
Site sub-div:	Grave fills	
Plan no: 7	Grave cut:	Finds None dep plate (soldered plain rect) p.b. Breastplate x grip (6 shield) + g. plate (Fe.) frags
Section no:	Skeleton:	
Co-ordinates:	Matrix location: in Bay 4	Hinge
Levels	Preservation:	Bracket
Slide No.	Neg No:	Fixing nails Shroud pins
		Fabric
		Other finds

Description adult p.p. coffin

Discussion

Shape, dimensions and distinguishing characteristics

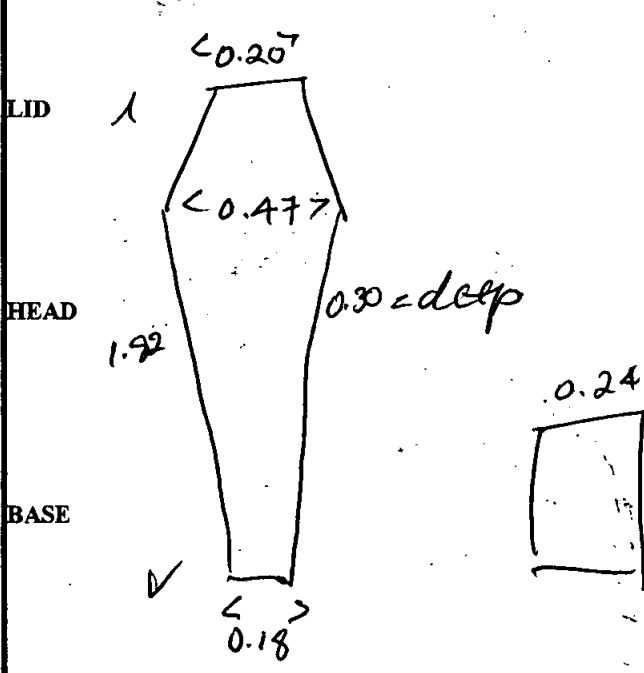

" Mrs  
Henry Gyles  
Died 27<sup>th</sup> April  
1838  
Aged 18 Years.

Recorder:	Date: 9/10	Initials: MR
-----------	---------------	-----------------

dlb

SITE 0LR00	COFFIN RECORD SHEET	CONTEXT NO. 598
Trench: CUMPT	Additional sheets:	Treatment: NO NAME - NO DNA - SKULLY LIFTED
Site sub-div:	Grave fills	
Plan no: 7	Grave cut:	Finds None
Section no:	Skeleton:	Breastplate Grip
Co-ordinates:	Matrix location: in box 4	Hinge Bracket
Levels	Preservation: 1.	Fixing nails Shroud pins
Slide No.	Neg No:	Fabric Other finds

Description  
adult p.b. coffin. lid euphored @ d. plate/shoulder area  
- body was bronned - poor condition.

Discussion

Shape, dimensions and distinguishing characteristics

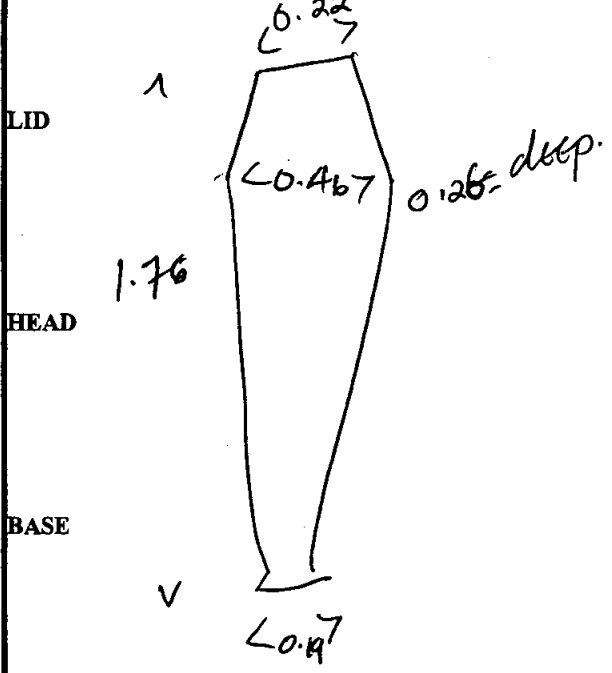

Recorder:	Date: 9/10	Initials: MR.
-----------	---------------	------------------

db

SITE 07200	COFFIN RECORD SHEET	CONTEXT NO. 599
Trench: 5C	Additional sheets: YES x 2	Treatment: SKELLY LIFTED
Site sub-div:	Grave fills	
Plan no: 6	Grave cut:	Findings None
Section no:	Skeleton:	Breastplate Grip plates x 2 tin db chs - (no grips) 3 x grips - new type
Co-ordinates:	Matrix location: in vault 196 under 535	Hinge Bracket
Levels	Preservation:	Fixing nails Shroud pins 4 x escutcheons (4)
Slide No.	Neg No:	Fabric Other finds

**Description** Wood coffin under 535

**Discussion**

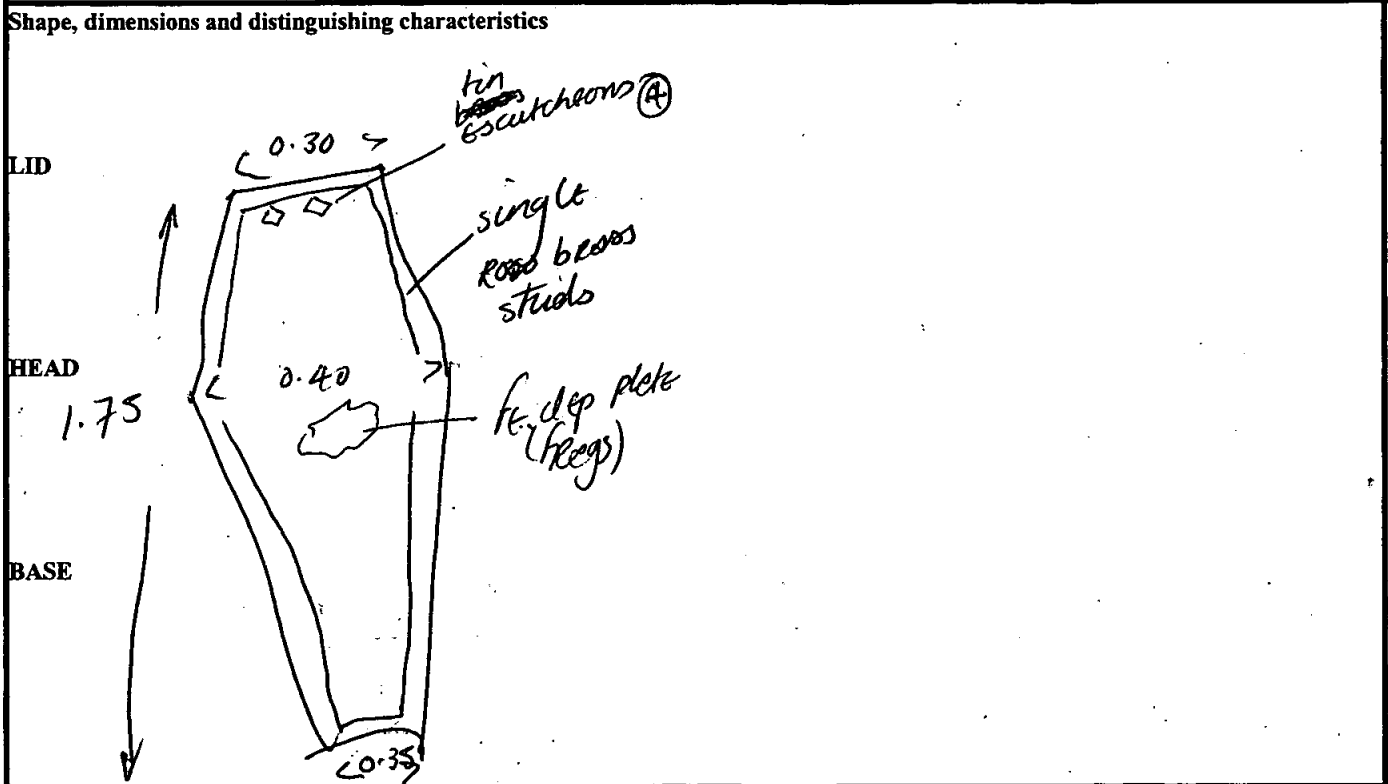

Recorder: Mel.	Date:	Initials:
-------------------	-------	-----------

Site Code

Context

**Outer Coffin**

Sample Ret.

02200

599

Recording Date ..... 10/10 .....

Associated Numbers ..... 600 .....

Condition .....

Dep. Plate

Legible

Inscription

Fabric lead  ormolou  brass  tin plated pewter  gilt tin   
 iron  silvered tin  enamelled  other ..... Sample Ret.

**Shape of dep. plate**

square  rectangle  shield  tapered  lozenge   
 cartouche  oval  other .....

**Upholstery**

colour ..... shoddy  velvet  other *boize.* ..... Sample Ret.

**Construction**

butt joint  mitred  pitched  other .....

**Grip plate**  <sup>B</sup>

Fabric = ormolou  brass  tin plated pewter  <sup>(3)</sup> gilt tin

iron  silvered tin  enamelled  other ..... Sample Ret.

**Grip**  <sup>25</sup>

Fabric = ormolou  brass  iron  Sample Ret.

**Design**

swag of rose  horseshoe  cherub's head  plain

other ..... *new type - see sheet.* .....

**Grip bolts**

Corner bolts  Type = gilt brass  brass  iron

other ..... Sample Ret.

**Lid motifs**

other *1 x (6) tin w/ (4) escutcheon attached to RHS* ..... Sample Ret.   
*single top of wing.*

**Escutcheons**

other *4 x (4) tin* ..... Sample Ret.

**Upholstery nails**

brass  gilt brass  silvered brass  iron  enamelled

other ..... Sample Ret.

**Fixings**

panel nails  screws  hinges  lace  Sample Ret.

**Timber type** .....

Sample Ret.

**Interpretation / Comments**

.....  
 .....

db

SITE <b>OR 200</b>	COFFIN RECORD SHEET	CONTEXT NO. <b>600</b>
Trench:	Additional sheets: <b>YES x2</b>	Treatments <b>BONES / SNA</b>
Site sub-div: <b>SC V.49</b>	Grave fills	
Plan no: <b>6</b>	Grave cut:	Finds None
Section no:	Skeleton: <b>BAD PRESERVATION</b>	Breastplate <input checked="" type="checkbox"/> Grip <input checked="" type="checkbox"/>
Co-ordinates:	Matrix location:	Hinge Bracket
Levels:	Preservation:	Fixing nails Shroud pins
Slide No.	Neg No:	Fabric Other finds

Description **WOODEN COFFIN WITHIN VAULT 497.**  
(Poss. broken)

Discussion

Shape, dimensions and distinguishing characteristics

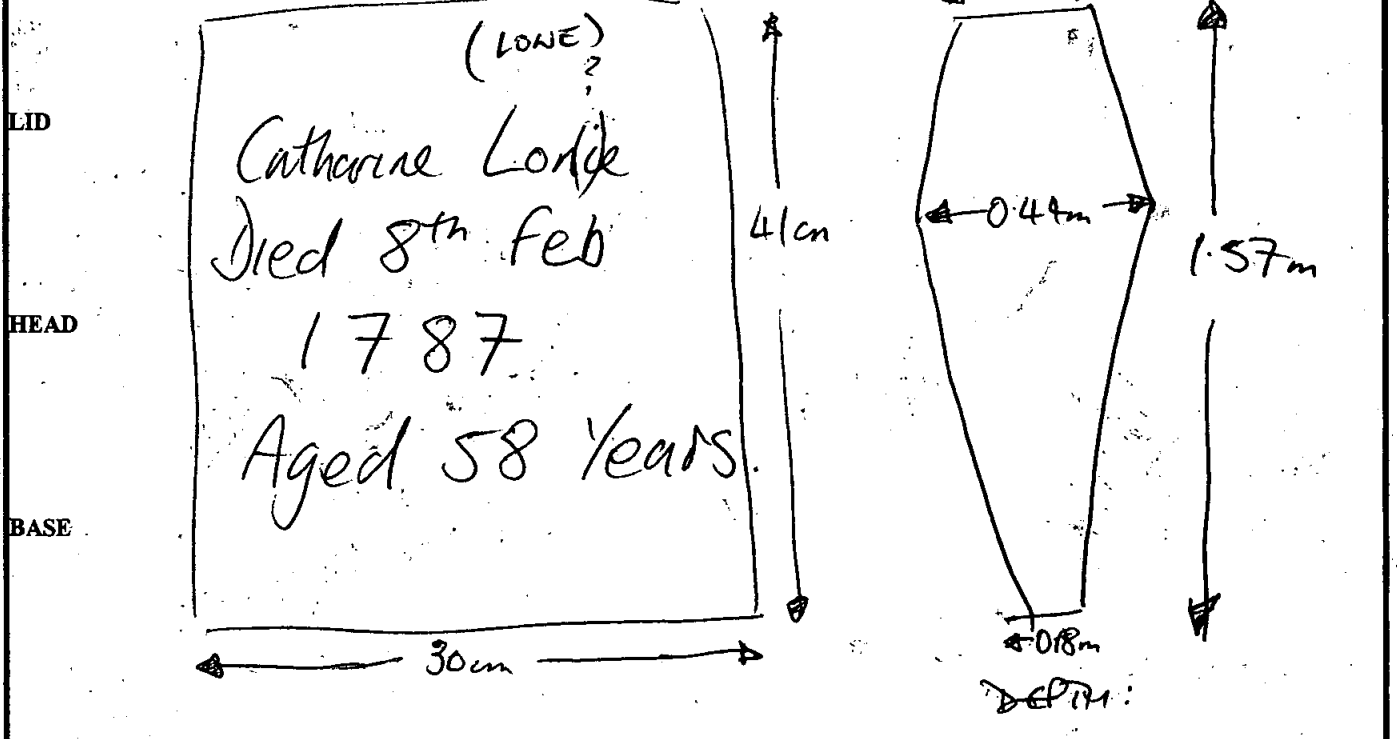

Recorder: <b>M</b>	Date: <b>10.10.00</b>	Initials:
--------------------	-----------------------	-----------



# Coffin Recording Sheet

Site Code

Context

02100

600

**Outer Coffin**

Sample Ret.

Recording Date ..... 10/10

Associated Numbers ..... 599

Condition ..... 3

Dep. Plate

Legible

Inscription *Womanine ~~James~~ / Died 8<sup>th</sup> Feb 9 / ~~1887~~ / Aged 58 Years  
1787  
~~Howe~~  
Howe..*

Fabric lead  ormolou  brass  tin plated pewter  (9) gilt tin   
iron  silvered tin  enamelled  other ..... Sample Ret.

**Shape of dep. plate**

square  rectangle  shield  tapered  lozenge   
cartouche  oval  other .....

**Upholstery**

colour ..... shoddy  velvet  other ..... Sample Ret.

**Construction**

butt joint  mitred  pitched  other .....

Grip plate  Fabric = ormolou  brass  tin plated pewter  (3) gilt tin   
iron  silvered tin  enamelled  other ..... Sample Ret.

Grip  Fabric = ormolou  brass  iron  Sample Ret.

Design swag of rose  horseshoe  cherub's head  plain   
other ..... *some do 599*

Grip bolts  Corner bolts  Type = gilt brass  brass  iron   
other ..... Sample Ret.

Lid motifs  other *gilt tin - 'Flaming urn' no match* Sample Ret.

Escutcheons  other *gilt tin (4) x 3* Sample Ret.

Upholstery *studs*  brass  gilt brass  silvered brass  iron  enamelled   
other ..... *o o o o o o o o o o - 1 piece total = 16* Sample Ret.

Fixings  panel nails  screws  hinges  lace  Sample Ret.

Timber type ..... Sample Ret.

**Interpretation / Comments**

.....  
.....

db

SITE		COFFIN RECORD SHEET		CONTEXT NO.	
OUR 00				601	
Trench:	Additional sheets:	Treatment: Bones collected/DNA			
Site sub-div: CRUAT	Grave fills:				
Plan no: 7	Grave cut:	Finds None			
Section no:	Skeleton:	Breastplate ✓ Grip ✓ ? where is it?			
Co-ordinates:	Matrix location: (601) ADJ. TO WESTERN END PATH TWO, GRUAT 15	Hinge Bracket			
Levels:	Preservation: DELAYED COFFIN	Fixing nails Shroud pins			
Slide No.:	Neg No.:	Fabric Other finds			

**Description**  
E-W ORIENTED INFANT BURIAL. WOODEN LEAD-LINED COFFIN NOT SOLDERED - PINN SEALED - INNER WOOD COFFIN. TWO INSCRIPTION PLATES ONE SOLDERED TO TOP OF LEAD LINING, SMALL RECTANGULAR PLATE LOCATED AT RIGHT HEAD SIDE OF COFFIN ON WOODEN OUTER CASE - PIN SEALED TOP & BOTTOM.

**Discussion**

**Shape, dimensions and distinguishing characteristics**

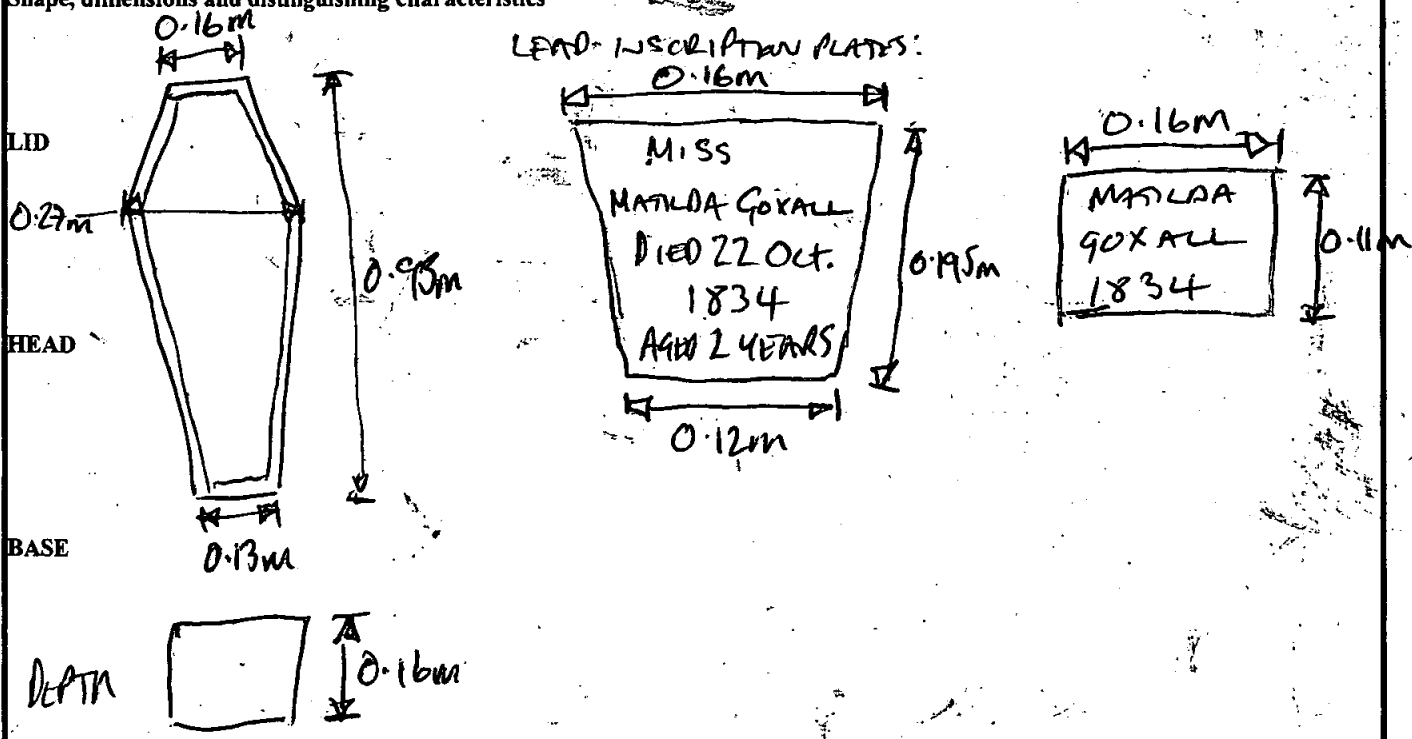

Recorder: DM	Date: 10/10/00	Initials:
--------------	----------------	-----------

db

SITE OLR 00	COFFIN RECORD SHEET	CONTEXT NO. 602
Trench:	Additional sheets:	Treatment: Bones collected / DNA
Site sub div: CHPT	Grave fills	
Plan no: 7	Grave cut:	Finds None
Section no:	Skeleton:	Breastplate ✓ Grip
Co-ordinates:	Matrix location: WEST. END BAY TWO, ADJ. TO VAULT 15	Hinge Bracket
Levels	Preservation: DECAYED COFFIN	Fixing nails Shroud pins
Slide No.	Neg No:	Fabric Other finds Δ-5

Description E-W ORIENTED WOODEN LEAD-LINED COFFIN - INNER WOOD LINED INSIDE. LEAD PINNED TOP AND BOTTOM - BREASTPLATE SOLIDLY TO TOP - SMALL FIND PRESENT - SMALL TIE PIN? - WHITE BONE JET BLUE GLASS PENDANT

Discussion

Shape, dimensions and distinguishing characteristics

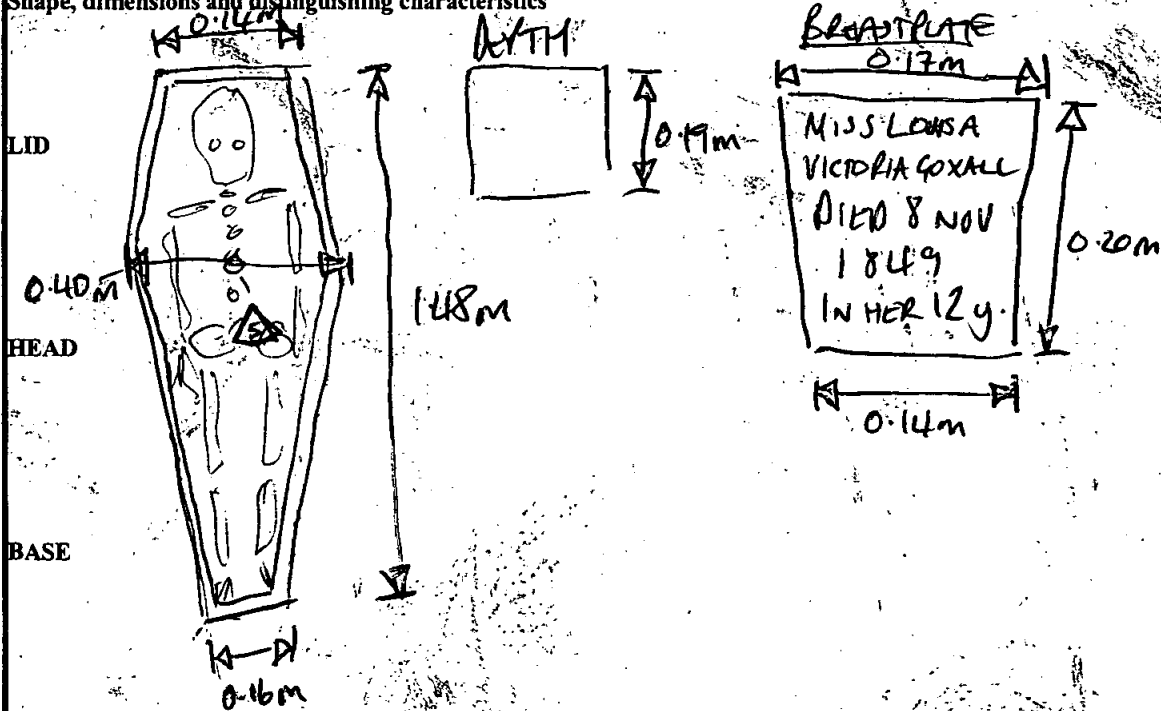

Recorder: <i>DM</i>	Date: 16/10/00	Initials:
---------------------	----------------	-----------

db

SITE	COFFIN RECORD SHEET	CONTEXT NO.
DLR00		603
Trench:	Additional sheets:	Treatment:
Site sub-div: CAMP 303	Grave fills	DNA/BONES
Plan no: 7	Grave cut:	Finds
Section no:	Skeleton:	None
Co-ordinates:	Matrix location: UNDERNEATH (532) (533)	Breastplate
Levels	Preservation: Corroded Pb Coffin	Grip
Slide No.	Neg No:	Hinge
		Bracket
		Fixing nails
		Shroud pins
		Fabric
		Other finds

Description

Discussion

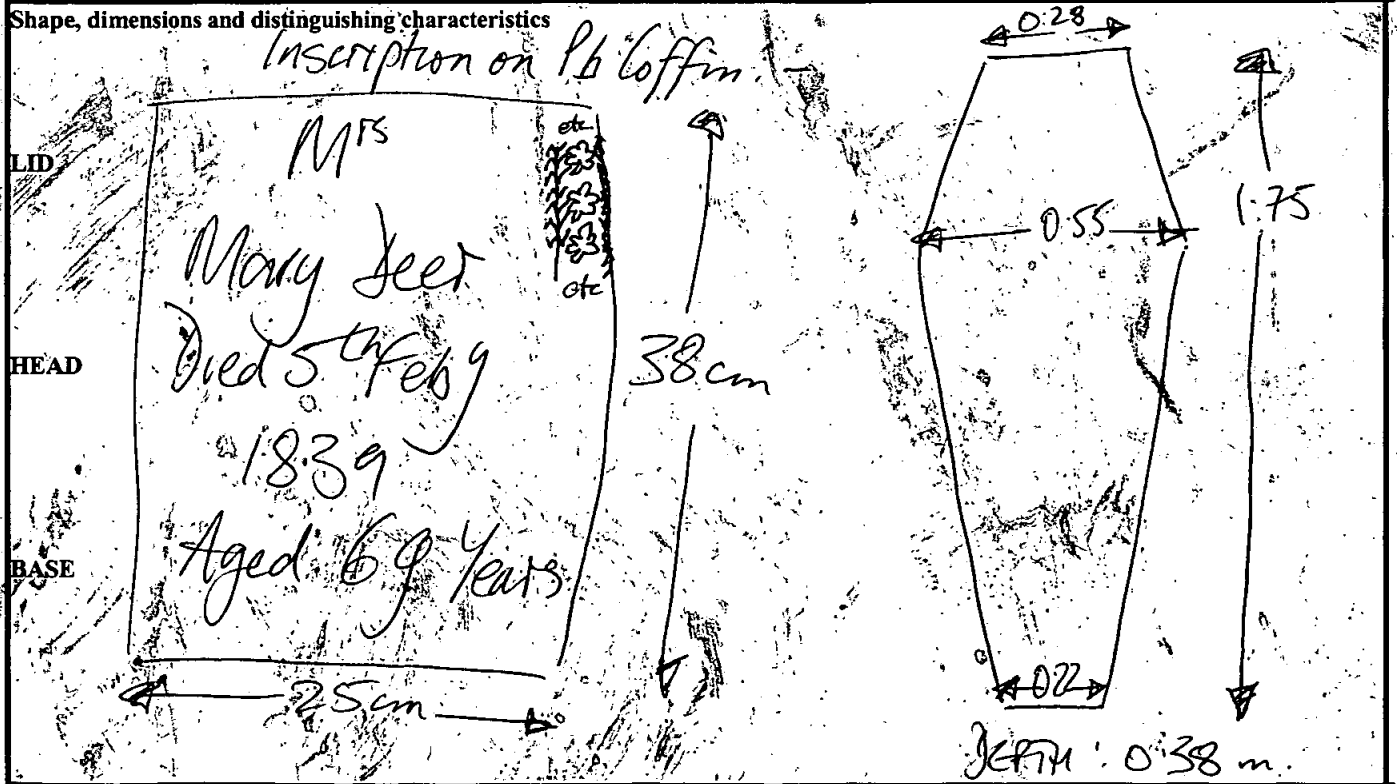

Recorder: M Date: 10/10/00 Initials:

db.

SITE	COFFIN RECORD SHEET	CONTEXT NO.
Trench: <i>SC</i>	Additional sheets:	Treatment: <i>SKELETON LIFTED</i>
Site sub-div: <i>V-III</i>	Grave fills	- <i>NO NAME - NO</i>
Plan no: <i>6</i>	Grave cut:	<i>DNA. *</i>
Section no:	Skeleton:	Finds None
Co-ordinates:	Matrix location: <i>in vault III</i>	Breastplate
Levels	Preservation:	Grip <i>36 (Fe)</i> <i>plate (Fe) (2) (5)</i>
Slide No.	Neg No:	Hinge
		Bracket
		Fixing nails
		Shroud pins
		Fabric
		Other finds

Description *Wood, lid missing, sides collapsed, prob. disturbed by deposition of 605*

Discussion  
*no measurements poss.*

Shape, dimensions and distinguishing characteristics

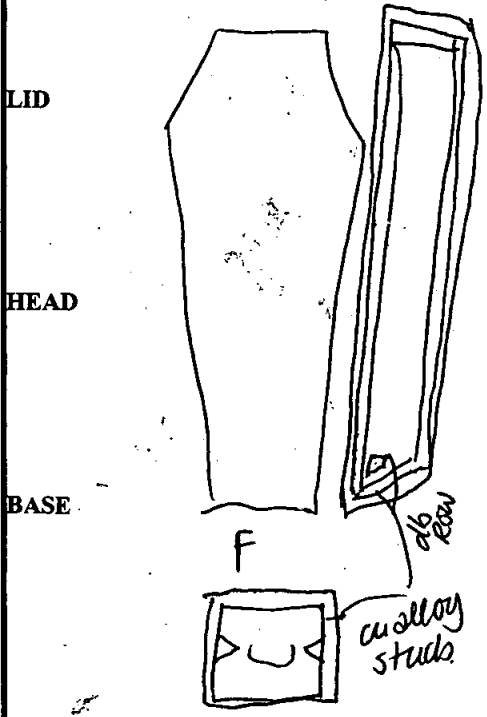

*\* There may be parts of 607 (adj) remaining in w/ this body.*

Recorder:	Date: <i>11/10</i>	Initials: <i>NR</i>
-----------	--------------------	---------------------



db

SITE		COFFIN RECORD SHEET		CONTEXT NO.	
02100				606	
Trench:	S.C.	Additional sheets:		Treatment: SKELLY LIFTED NO NAME-NO DATA	
Site sub-div:	V. III	Grave fills			
Plan no:	6.	Grave cut:		Finds None ✓	
Section no:		Skeleton:		Breastplate Grip x1 fb + plate frag	
Co-ordinates:		Matrix location: MER (608) IN V. III		Hinge Bracket = 0.14 long = drop = 0.05	
Levels		Preservation: ROTTEN		Fixing nails Shroud pins  spltds (5)	
Slide No.		Neg No:		Fabric Other finds	

Description: Wood Coffin - BADLY PRESERVED.

Discussion: MIXED IN WITH 608 / 609.  
NO MEASUREMENTS POSSIBLE.

Shape, dimensions and distinguishing characteristics

LID

HEAD

BASE

Recorder:	Date:	Initials:
PM	11-10-00-	

db

SITE		COFFIN RECORD SHEET		CONTEXT NO.	
Or 100				607	
Trench:	S.C.	Additional sheets:	Treatment: SKELLY LIFTED, NO NAME - NO DNA		
Site sub-div:	V. III	Grave fills			
Plan no:	6	Grave cut:	Finds None		
Section no:		Skeleton:	Breastplate Grip		
Co-ordinates:		Matrix location: IN vault 111 w/ 605	Hinge Bracket		
Levels		Preservation:	Fixing nails Shroud pins		
Slide No.		Neg No:	Fabric Other finds		
<p>Description</p> <p>wood coffin, v. compressed, <del>completely</del> destroyed on stone floor of vault - presence of <del>wooden</del> studs - too fragmentary to <del>any</del> recognise pattern.</p> <p>Discussion</p> <p>no. measurements poss</p>					
<p>Shape, dimensions and distinguishing characteristics</p> <p>LID</p> <p>HEAD</p> <p>BASE</p>					
Recorder:	Date:		11/10	Initials: MR.	



db

SITE <i>02100</i>	COFFIN RECORD SHEET	CONTEXT NO. <i>608</i>
Trench: <i>SC</i>	Additional sheets:	Treatment: <i>BONES REMOVED - NO DATA (NO NAME)</i>
Site sub-div:	Grave fills	
Plan no: <i>6</i>	Grave cut:	Finds None
Section no:	Skeleton:	Breastplate Grip <input checked="" type="checkbox"/> <i>x1 fe</i> <sup>①</sup> <del>breastplate</del> <del>XXXX</del>
Co-ordinates:	Matrix location: <i>in vault 111</i> <i>dv. 606</i>	Hinge <i>20.08 long</i> Bracket
Levels	Preservation:	Fixing nails Shroud pins
Slide No.	Neg No:	Fabric Other finds

Description  

*u. alloy studwork present. wood coffin*  
*INFANT*

Discussion  
*no measurements poss.*

Shape, dimensions and distinguishing characteristics

LID

HEAD

BASE

Recorder: <i>MR.</i>	Date: <i>11.10.00</i>	Initials:
-------------------------	--------------------------	-----------

db

SITE Orlloo.	COFFIN RECORD SHEET	CONTEXT NO. 609
Trench: SC	Additional sheets: YES X1	Treatment: <del>NO PLATE NO DNA</del> BONES LIFTED. DNA TAKEN
Site sub-div: V. III	Grave fills	
Plan no: 6.	Grave cut:	Finds None
Section no:	Skeleton:	Breastplate * X1 P.b. dep plate + 1 inscript. Grip X2 (ONE) w/gp frags(fe) - UN ID.
Co-ordinates:	Matrix location: UNDER 608 V. III	Hinge
Levels	Preservation:	Bracket
Slide No.	Neg No:	Fixing nails Shroud pins
		Fabric Other finds

Description  
P.D. ADULT

MRS  
SUSANNA ROGERS  
Died 26<sup>th</sup> Octo  
1761  
Aged 47

Discussion  
No MEASUREMENTS POSS

Shape, dimensions and distinguishing characteristics

LID  
w Alloy Studs

HEAD

BASE

"Mrs  
Susanna Rogers  
Died 26<sup>th</sup> Octo<sup>r</sup>  
1761  
Aged 47."  
no match.

Recorder: MR      Date: 4-10-      Initials:

db

SITE	COFFIN RECORD SHEET	CONTEXT NO.
OLR00		610
Trench:	Additional sheets: Yes x 1	Treatment: <del>XXXX</del> DNA/BONES.
Site sub-div: CRPT:BM2	Grave fills	
Plan no:	Grave cut:	Finds None
Section no:	Skeleton:	Breastplate ✓ Coffin Plate. Grip x 2
Co-ordinates:	Matrix location:	Hinge Bracket
Levels	Preservation: Good - <del>XXXX</del> resh/rewr. - corroded at Bott/Sides.	Fixing nails Shroud pins
Slide No.	Neg No: slightly waterlogged.	Fabric Other finds

Description  
Pb Coffin inscript.  
Soldered Plate:

Mrs  
Cordelia Eliza<sup>th</sup>  
- Scotter -  
Died 12<sup>th</sup> Augt  
1853  
In her 28<sup>th</sup> Year

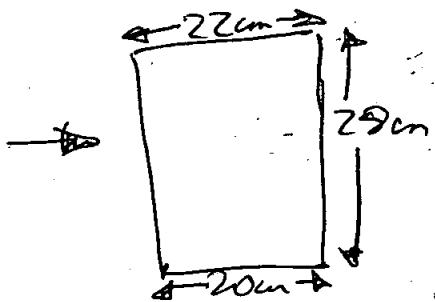

Discussion

Shape, dimensions and distinguishing characteristics

Small Plate

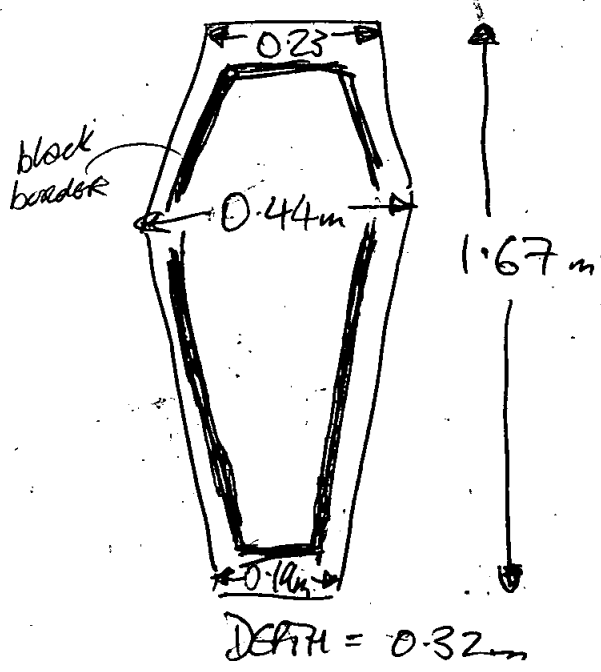
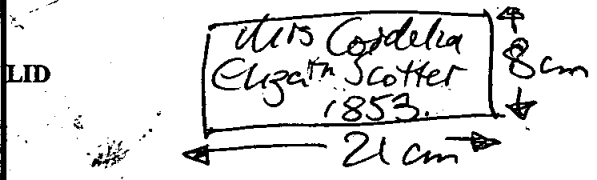

HEAD

BASE

Recorder: <i>DM</i>	Date: 11.10.00.	Initials:
---------------------	-----------------	-----------

Site Code

Context

OK200

610

**Outer Coffin**

Sample Ret.

Recording Date *11/10*

Associated Numbers .....

Condition .....

Dep. Plate

Legible

Inscription *Mrs <sup>2</sup> Cordelia / Eliza<sup>th</sup> Scotter / 1853*

Fabric lead  ormolou  brass  tin plated pewter  gilt tin   
 iron  silvered tin  enamelled  other ..... Sample Ret.

**Shape of dep. plate**

square  rectangle  shield  tapered  lozenge   
 cartouche  oval  other ..... *Plain-foot plate?*

**Upholstery**

colour ..... shoddy  velvet  other ..... Sample Ret.

**Construction**

butt joint  mitred  pitched  other .....

**Grip plate**

Fabric = ormolou  brass  tin plated pewter  gilt tin   
 iron  silvered tin  enamelled  other ..... Sample Ret.

*cartouche key on rev of grip.*

**Grip**

Fabric = ormolou  brass  iron  *2 opt fds ①* Sample Ret.

**Design**

swag of rose  horseshoe  cherub's head  plain

other .....

**Grip bolts**

Corner bolts  Type = gilt brass  brass  iron

other ..... Sample Ret.

**Lid motifs**

other .....

**Escutcheons**

other .....

**Upholstery nails**

brass  gilt brass  silvered brass  iron  enamelled

other ..... Sample Ret.

**Fixings**

panel nails  screws  hinges  lace  Sample Ret.

**Timber type** .....

Sample Ret.

**Interpretation / Comments**

.....  
 .....

26

SITE	COFFIN RECORD SHEET	CONTEXT NO.
AL 200		611
Trench:	Additional sheets: YES x1	Treatment: INTACT
Site sub-div: COFFIN BAY 2	Grave fills:	
Plan no: 7	Grave cut:	Finds: None
Section no:	Skeleton:	Breastplate x1 (+ INSCRIPTION)
		Grip x1
Co-ordinates:	Matrix location:	Hinge
		Bracket
Levels:	Preservation: SLIGHT CORROSION ON LID.	Fixing nails
		Shroud pins
Slide No.:	Neg No.:	Fabric
		Other finds:

Description: Pb Coffin Footplate

Discussion:

Master Charles  
Henry Yoxall  
1837

16cm

11cm

Shape, dimensions and distinguishing characteristics

Inscription:

Master Charles  
Henry Yoxall  
Died 1st April  
1837 Aged  
7 Years 6 Mon<sup>92</sup>

0.17  
0.32  
0.13  
1.16m  
DEATH: 0.24m

LID

HEAD

BASE

Recorder: M Date: 17.10.00. Initials:

R

**Outer Coffin**

Sample Ret.

Site Code

Context

Recording Date ..... 18/10 .....

Oh100

611  
~~611~~

Associated Numbers .....

Condition ..... 3 .....

Dep. Plate

Legible

Inscription "Master Charles / Henry Yoxall / 1837"

Fabric lead  ormolou  brass  tin plated pewter  gilt tin   
 iron  silvered tin  enamelled  other ..... Sample Ret.

**Shape of dep. plate**

square  rectangle  shield  tapered  lozenge   
 cartouche  oval  other ..... plain & small = 0.16 x 0.11.

**Upholstery**

colour ..... shoddy  velvet  other ..... Sample Ret.

**Construction**

butt joint  mitred  pitched  other .....

**Grip plate**

Fabric = ormolou  brass  tin plated pewter  gilt tin   
 iron  silvered tin  enamelled  other ..... Sample Ret.

**Grip**

Fabric = ormolou  brass  iron  Sample Ret.

**Design**

swag of rose  horseshoe  cherub's head  plain   
 other .....

**Grip bolts**

Corner bolts  Type = gilt brass  brass  iron   
 other ..... Sample Ret.

**Lid motifs**

other ..... Sample Ret.

**Escutcheons**

other ..... Sample Ret.

**Upholstery**

studs  
 brass  gilt brass  silvered brass  iron  x 2 pieces enamelled

other ..... 1 x  / 1 x  = total of 10 studs. Sample Ret.

**Fixings**

panel nails  screws  hinges  lace  Sample Ret.

**Timber type** .....

Sample Ret.

**Interpretation / Comments**

.....  
 .....

dp

SITE GLR00	COFFIN RECORD SHEET	CONTEXT NO. 612
Trench: CRYPT	Additional sheets:	Treatment: REMAINS COMPLETELY DISINTEGRATED NO DNA / NO BONES
Site sub-div:	Grave fills:	
Plan no: 7	Grave cut:	Finds: None
Section no:	Skeleton:	Breastplate ✓ Red plain soldered Grip ✓ x1 Fe spthb (D)
Co-ordinates:	Matrix location: in box 3 adj to 613, of 614	Hinge Bracket
Levels:	Preservation:	Fixing nails Shroud pins
Slide No.:	Neg No.:	Fabric Other finds

Description: adult pb coffin, body burned - nothing surviving.

Discussion

Shape, dimensions and distinguishing characteristics

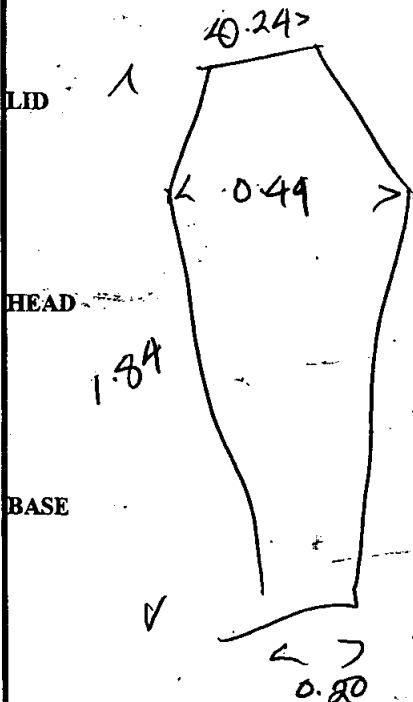

" MR  
John Sowler  
died 18th May  
1792 "  
Aged 45 years.  
= 0.24 deep

Recorder: Met	Date: 12/10	Initials:
---------------	-------------	-----------

db

SITE <i>OH200</i>	COFFIN RECORD SHEET	CONTEXT NO. <i>613</i>
Trench: <i>CRYPT</i>	Additional sheets:	Treatment: <i>BODY DISINTEGRATED UNLIFTABLE, NO DNA</i>
Site sub-div:	Grave fills	
Plan no: <i>7</i>	Grave cut:	Finds None Breastplate <i>x 1 pb rect plain</i>
Section no:	Skeleton:	Grip
Co-ordinates:	Matrix location: <i>in Box 3 adj. to 612, of 614</i>	Hinge Bracket
Levels	Preservation: <i>1</i>	Fixing nails Shroud pins
Slide No.	Neg No:	Fabric Other finds

Description  
*adult, body browned, & largely disintegrated except skull frag. @ v. top inner side, base of coffin badly detached.*

Discussion

Shape, dimensions and distinguishing characteristics

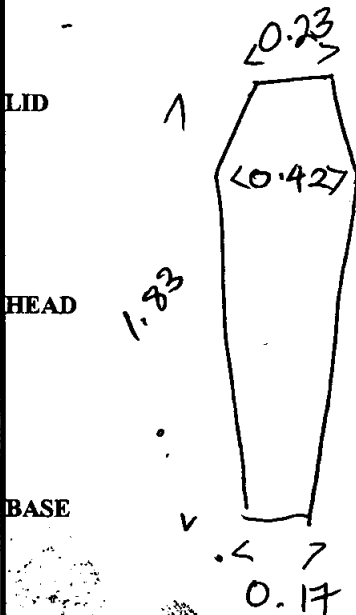

*Mary Newton  
 Obit 18 Dec<sup>R</sup>  
 1811*

Recorder:	Date:	Initials:
-----------	-------	-----------



db

SITE OLR00	COFFIN RECORD SHEET	CONTEXT NO. 614
Trench: CRMPT	Additional sheets:	Treatment: SKELETON LIFTED & DNA TAKEN
Site sub-div:	Grave fills	
Plan no: 7	Grave cut:	Finds None + inscription ✓ x 1 pb (top) ②
Section no:	Skeleton:	Breastplate ✓ x 2 spltds ① Grip ✓ x 2 spltds ①
Co-ordinates:	Matrix location: 4/ 612 & 613	Hinge Bracket
Levels	Preservation: 2	Fixing nails Shroud pins
Slide No.	Neg No:	Fabric Other finds

Description

Discussion

Shape, dimensions and distinguishing characteristics

①  
" Elizabeth Egnor  
Died 20th Feb'y  
1773  
Aged 51 years" ②?  
③  
" MRS.  
Elizabeth Egnor  
Died 20th Feb'y  
1773  
Aged 51 YEARS'

Recorder: MGL	Date: 12/10	Initials:
---------------	-------------	-----------

SITE <i>OLR 00</i>		COFFIN RECORD SHEET		CONTEXT NO. <i>615</i>	
Trench:		Additional sheets:		Treatment: <i>Bones collected.</i>	
Site sub-div: <i>NC</i>		Grave fills <i>/</i>			
Plan no: <i>3</i>		Grave cut: <i>/</i>		Finds None <input checked="" type="checkbox"/>	
Section no:		Skeleton: <i>615</i>		Breastplate Grip	
Co-ordinates:		Matrix location: <i>Mixed with (211)</i>		Hinge Bracket	
Levels		Preservation: <i>POOR.</i>		Fixing nails Shroud pins	
Slide No.		Neg No:		Fabric Other finds	
<p>Description <i>E-W Adult, mixed in grave with 211, Most missing, only found at osteological level of recording - not seen in ground damaged through excavation.</i></p> <p>Discussion</p>					
<p>Shape, dimensions and distinguishing characteristics</p> <p>LID</p> <p>HEAD</p> <p>BASE</p>					
Recorder:		Date:		Initials:	

bb

SITE OLR08	COFFIN RECORD SHEET	CONTEXT NO. 616
Trench: CRMPY	Additional sheets:	Treatment: SKULLS LIFTED DNA LIFTED
Site sub-div:	Grave fills	
Plan no: 7	Grave cut:	Finds None Breastplate x 1"p. 6 (rect)
Section no:	Skeleton:	Grip
Co-ordinates:	Matrix location: in Bay 3	Hinge Bracket
Levels	Preservation: 2	Fixing nails Shroud pins
Slide No.	Neg No:	Fabric Other finds

Description

Discussion

Shape, dimensions and distinguishing characteristics

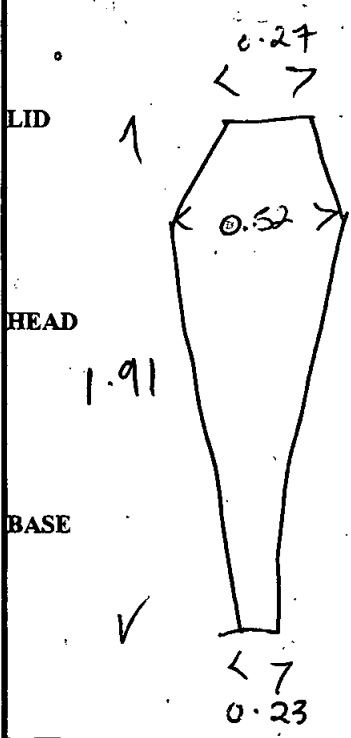

0.52 = deep

MR  
George Girsewood  
Died 19th Nov  
1790  
In his 48 years  
Sptfdo (20)

Recorder:	Date:	Initials:
-----------	-------	-----------

db

SITE OLR08	COFFIN RECORD SHEET	CONTEXT NO. 017
Trench: CRMP1	Additional sheets:	Treatment: SKELETON LIFTED & DNA TAKEN... NO TEETH
Site sub-div:	Grave fills	
Plan no: 7	Grave cut:	Finds None x 2 - 1 pb bp (a) 1 pb rect (b)
Section no:	Skeleton:	Breastplate ✓ Grip
Co-ordinates:	Matrix location: 11 Box 2	Hinge Bracket
Levels	Preservation:	Fixing nails Shroud pins
Slide No.	Neg No:	Fabric Other finds

Description  
adult p.b coffin

Discussion

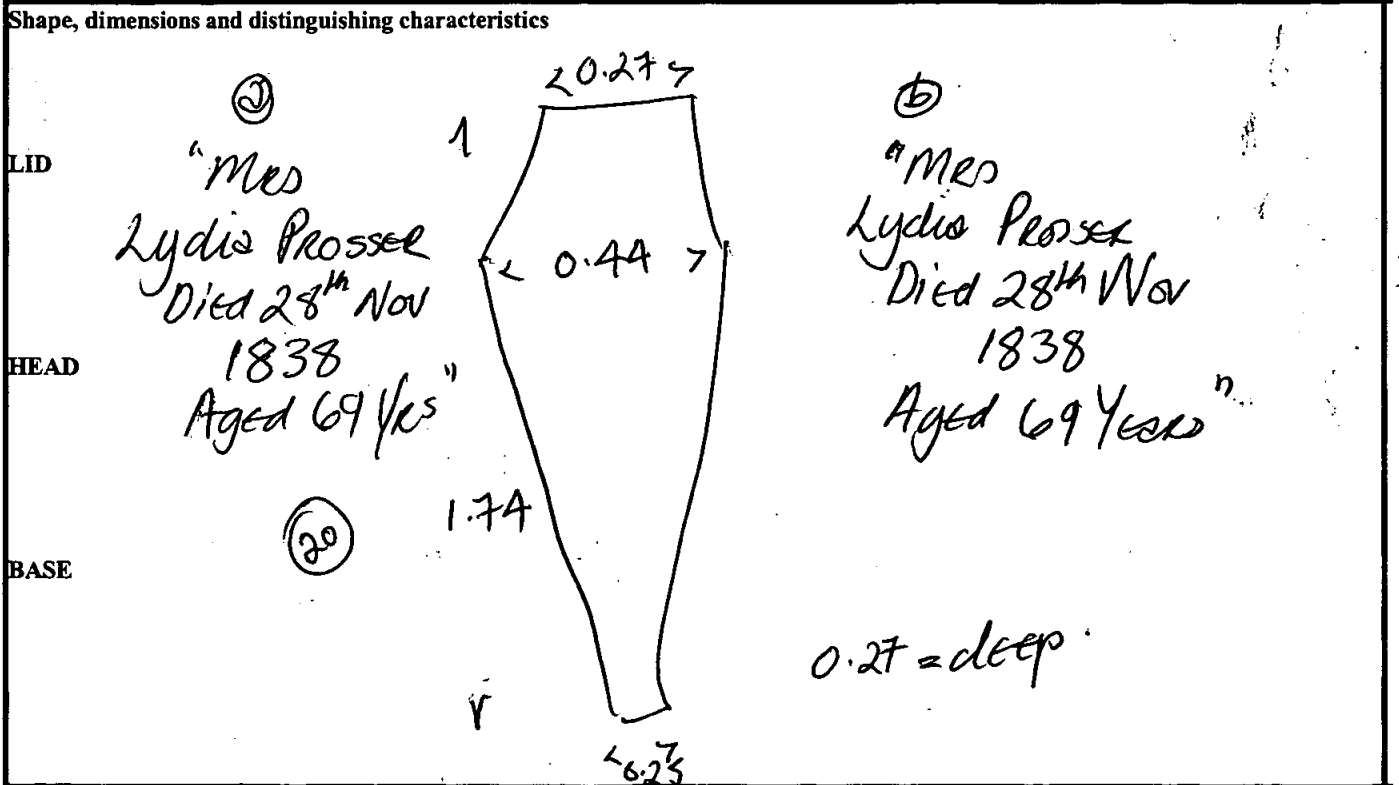

Recorder:	Date:	Initials:
-----------	-------	-----------

db

SITE 02200	COFFIN RECORD SHEET	CONTEXT NO. 618.
Trench:	Additional sheets: YES x1	Treatment: DNA - bones - NO TEETH.
Site sub-div: CLYPT: BAY 2	Grave fills	
Plan no: 7	Grave cut:	Finds None
Section no:	Skeleton: MOST OF UPPER BODY MISSING THEN DECAY.	Breastplate x2 ✓ <del>1</del>
Co-ordinates:	Matrix location:	Grip
Levels	Preservation: Coffin Corroded/leached	Hinge
Slide No.	Neg No:	Bracket
		Fixing nails
		Shroud pins
		Fabric
		Other finds

Description  
Pb Coffin-leached Breastplate:

Discussion  
Mifs  
Ann Seward  
Died 7 Jan 9  
1839  
Aged 72.

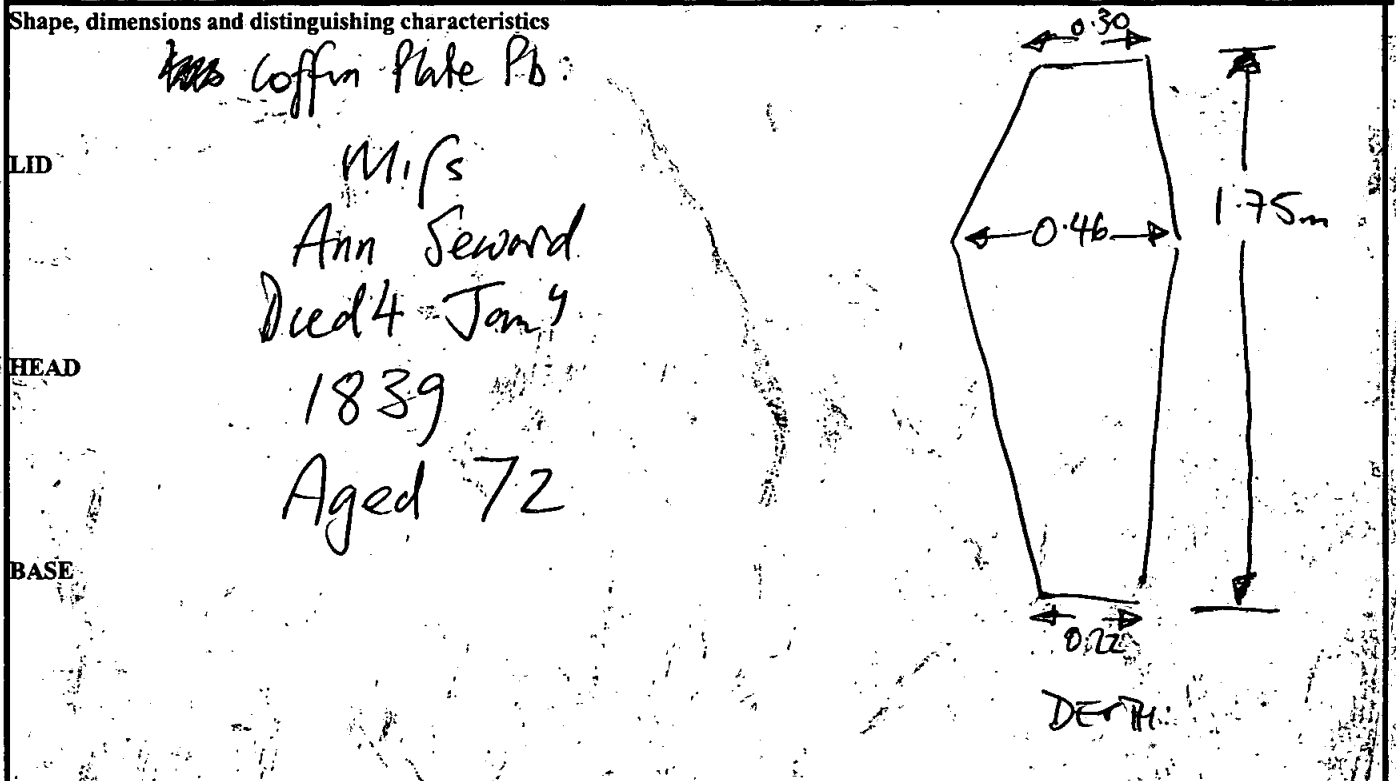

Recorder: DM	Date: 17.10.00	Initials:
-----------------	-------------------	-----------

**Outer Coffin**

Sample Ret.

Site Code

Context

OR200

618

Recording Date ..... 18/10 .....

Associated Numbers .....

Condition .....

Dep. Plate

Legible

Inscription "Miss/Ann Seward/Died 4 Jan<sup>r</sup>/1839/Aged 72"  
 (21) w/ diff borders.

Fabric lead  ormolou  brass  tin plated pewter  gilt tin   
 iron  silvered tin  enamelled  other ..... Sample Ret.   
*black polished*

**Shape of dep. plate**

square  rectangle  shield  tapered  lozenge   
 cartouche  oval  other .....

**Upholstery**

colour ..... shoddy  velvet  other ..... Sample Ret.

**Construction**

butt joint  mitred  pitched  other .....

**Grip plate**  Fabric = ormolou  brass  tin plated pewter  gilt tin   
 iron  silvered tin  enamelled  other ..... Sample Ret.

**Grip**  Fabric = ormolou  brass  iron  Sample Ret.

**Design**

swag of rose  horseshoe  cherub's head  plain

other .....

**Grip bolts**  **Corner bolts**  **Type =** gilt brass  brass  iron

other ..... Sample Ret.

**Lid motifs**  other ..... Sample Ret.

**Escutcheons**  other ..... Sample Ret.

**Upholstery nails**  brass  gilt brass  silvered brass  iron  enamelled

other ..... Sample Ret.

**Fixings**  panel nails  screws  hinges  lace  Sample Ret.

**Timber type** ..... Sample Ret.

**Interpretation / Comments**

.....  
 .....

db

SITE	COFFIN RECORD SHEET	CONTEXT NO.
Wootton		619
Trench:	Additional sheets:	Treatment: BONES LIFTED DNA - NO TEETH
Site sub-div: 8. v. 126	Grave fills	
Plan no: 6	Grave cut:	Finds None + inscription (a) Breastplate ✓ x 7 p.b. (b) Grip x 3 (c)
Section no:	Skeleton:	Hinge Bracket
Co-ordinates:	Matrix location: in vault 126 of 620 TOP	Fixing nails Shroud pins
Levels	Preservation: BADLY CORRODED - PART OF SKELETON - TORSO/HEAD ON OR IN (620) BELOW.	Fabric Other finds
Slide No.	Neg No:	

**Description**  
p.b. adult coffin - bottom corroded inscription on coffin -  
+ fallen out (skull + inner coffin) (a) Charles Cole  
Esq.  
Died 18th January  
1840  
In his 82<sup>nd</sup> year.

**Discussion**

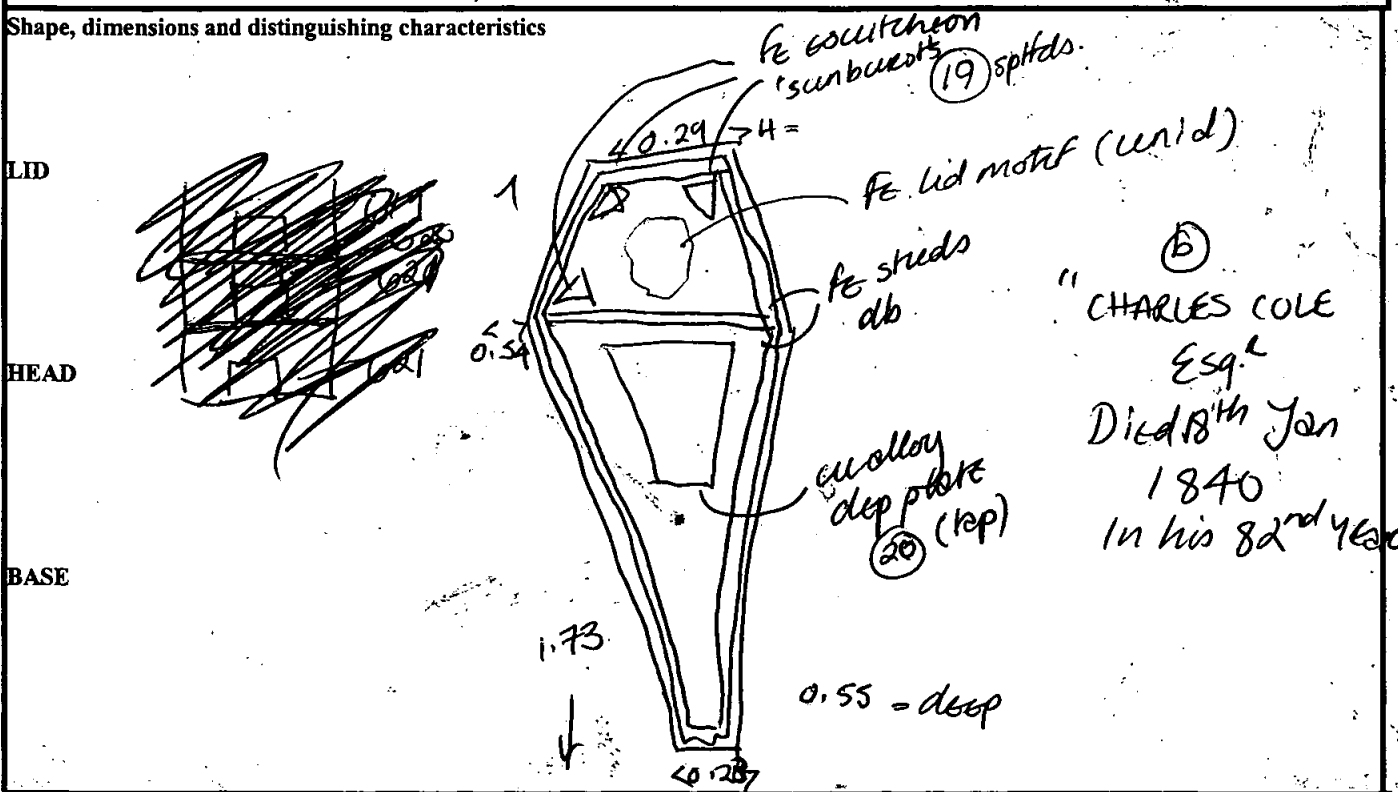

Recorder: m / dm Date: 4/12/10 00 Initials:

110

SITE OL-100.	COFFIN RECORD SHEET	CONTEXT NO. 620
Trench:	Additional sheets: X 1	Treatment: SKELLY LIFTED. NO TEETH - DNA TAKEN
Site sub-div: SC. V.126	Grave fills	
Plan no: 6.	Grave cut:	Finds ✓ ag. 600 rings (small hoops) None
Section no:	Skeleton:	Breastplate ✓ x 1 cu alloy (top). <del>plate</del> plate ✓ = spltd (20) x 4 (3) pb.
Co-ordinates:	Matrix location: UNDER 619	Hinge grip x 2 = spltd (black) (4) ft.
Levels	Preservation: Corroded Top	Bracket
Slide No.	Neg No:	Fixing nails
		Shroud pins
		Fabric
		Other finds

**Description** ~~16~~ 16 Coffin within brick grave [126] part of Sunburst? lid motif - unid.

**Discussion** Body has ossified tumour? in sacrum/coxxix region.

BRASS NO: (20) (TAP)  
SOPHIA COLE  
Died 13th Feb'y  
1839  
In her 76th Year

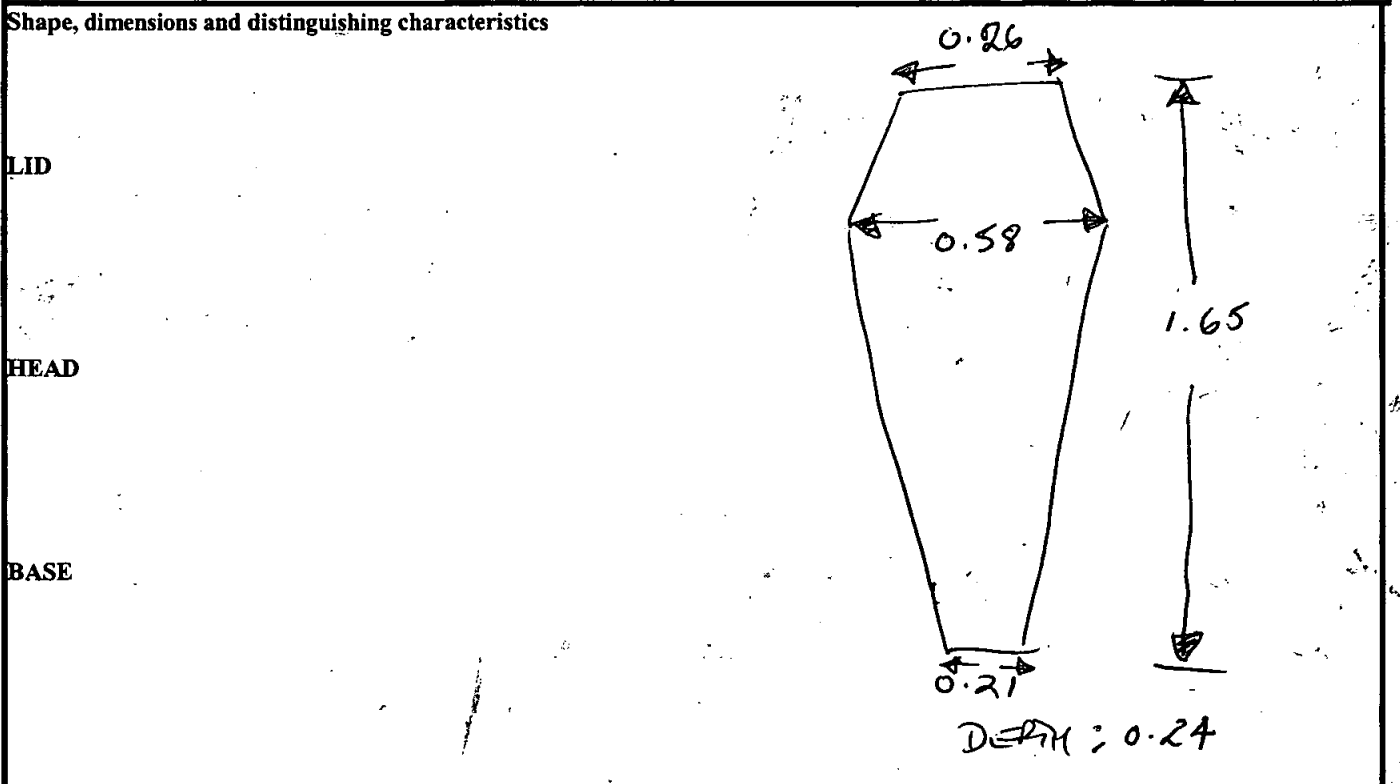

Recorder: <i>SM</i>	Date: 13.10.00	Initials:
---------------------	----------------	-----------



Site Code

Context

OK100

620

**Outer Coffin**

Sample Ret.

Recording Date ..... 13/10 .....

Associated Numbers .....

Condition .....

Dep. Plate

Legible

Inscription "SOPHIA COLE / Died 13<sup>th</sup> Feb<sup>ry</sup> / 18.3.9 / in her 76<sup>th</sup> year

Fabric lead  ormolou  brass  tin plated pewter  gilt tin   
 iron  silvered tin  enamelled  other ..... Sample Ret.

**Shape of dep. plate**

square  rectangle  shield  tapered  lozenge   
 cartouche  oval  other ..... sptfds. (20)

**Upholstery**

colour ..... shoddy  velvet  other *woize* ..... Sample Ret.

**Construction**

butt joint  mitred  pitched  other .....

Grip plate  Fabric = ormolou  brass  tin plated pewter  gilt tin   
 iron  silvered tin  enamelled  other ..... Sample Ret.

Grip  Fabric = ormolou  brass  iron  Sample Ret.

Design swag of rose  horseshoe  cherub's head  plain   
 other .....

Grip bolts  Corner bolts  Type = gilt brass  brass  iron   
 other ..... Sample Ret.

Lid motifs }  other *dec. fr. frag of plate, prob. part of lid motif - unid.* ..... Sample Ret.

Escutcheons }  other ..... Sample Ret.

Upholstery nails  brass  gilt brass  silvered brass  iron  enamelled   
 other ..... Sample Ret.

Fixings  panel nails  screws  hinges  lace  Sample Ret.

Timber type ..... Sample Ret.

**Interpretation / Comments**

.....  
 .....

db

SITE: 0CR00	COFFIN RECORD SHEET	CONTEXT NO. 621
Trench: S.C.	Additional sheets: YES x1	Treatment: SKELLY LIFTED. NO TEETH, DNA TAKEN
Site sub-div:	Grave fills	
Plan no: 6.	Grave cut:	Finds None
Section no:	Skeleton:	Breastplate - Rect. p.b. ② w/diff outer border Grip x1 - Rect. p.b. ③ plain soldered. Hinge (black enamelled)
Co-ordinates:	Matrix location: in vault 126 4/620.	Bracket up studs - fe db row Fixing nails
Levels	Preservation:	Shroud pins
Slide No.	Neg No:	Fabric Other finds

Description: pb coffin:

Discussion:

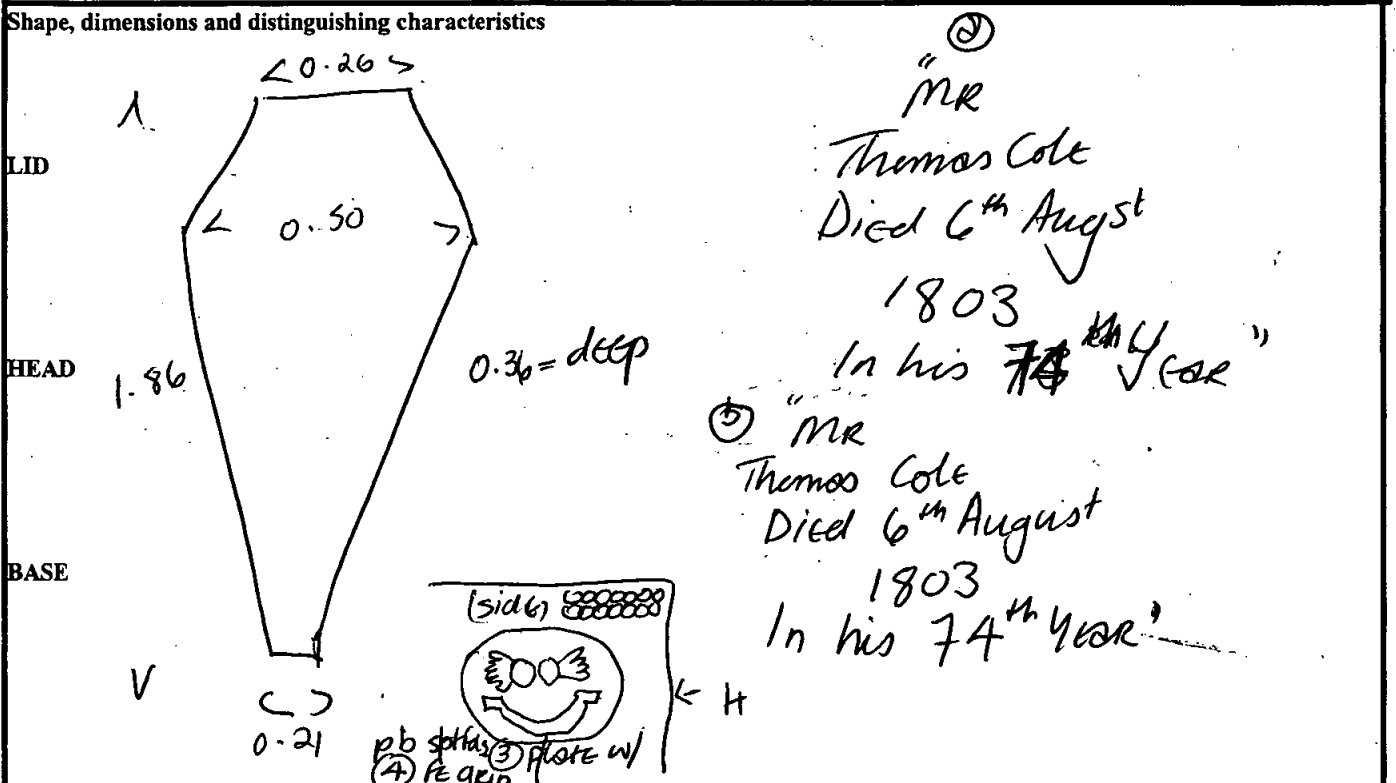

Recorder: \_\_\_\_\_ Date: \_\_\_\_\_ Initials: \_\_\_\_\_

Site Code

Context

02R00

621

**Outer Coffin**

Sample Ret.

Recording Date ..... 13/10 .....

Associated Numbers .....

Condition .....

Dep. Plate

Legible

Inscription "MR / Thomas Cole / Died 6<sup>th</sup> August / 1803 / In his 73<sup>rd</sup> Year"

Fabric lead  ormolou  brass  tin plated pewter  gilt tin   
 iron  silvered tin  enamelled  other ..... Sample Ret.

**Shape of dep. plate**

*spltdo 8 w/ dist. outer border.*

square  rectangle  shield  tapered  lozenge   
 cartouche  oval  other .....

**Upholstery**

colour ..... shoddy  velvet  other *boise* ..... Sample Ret.

**Construction**

butt joint  mitred  pitched  other .....

**Grip plate**  Fabric = ormolou  brass  tin plated pewter  gilt tin   
 iron  silvered tin  enamelled  other ..... Sample Ret.

**Grip**  Fabric = ormolou  brass  iron  Sample Ret.

**Design**

swag of rose  horseshoe  cherub's head  plain

other .....

**Grip bolts**  **Corner bolts**  **Type =** gilt brass  brass  iron

other ..... Sample Ret.

**Lid motifs**  other ..... Sample Ret.

**Escutcheons**  other ..... Sample Ret.

**Upholstery nails**  brass  gilt brass  silvered brass  iron  enamelled

other ..... Sample Ret.

**Fixings**  panel nails  screws  hinges  lace  Sample Ret.

**Timber type** ..... Sample Ret.

**Interpretation / Comments**

.....  
 .....

dp

SITE		COFFIN RECORD SHEET		CONTEXT NO.	
Trench:	56	Additional sheets:		Treatment:	SKULLY LIFTED & DATA TAKEN
Site sub-div:	V. 126.	Grave fills:		Finds:	⑧ w/out outer boarder x 1 pb. rect.
Plan no:	6	Grave cut:		Breastplate:	1 sptfids x 2
Section no:		Skeleton:		Grip:	fo ④ sptfids x 2 2 plates pb. ③ sptfids x 2 cl from foot smaller by
Co-ordinates:		Matrix location:	in Vault 126 a/ 621	Hinge:	0.06 - ten - both black enamelled
Levels:		Preservation:	poor - v. CORRODED. SKULLY v. FRAGILE IN PLACES ESP. SKULL	Bracket:	
Slide No.:		Neg No.:		Fixing nails:	
				Shroud pins:	
				Fabric:	
				Other finds:	

Description: Pb Coffin lining<sup>full</sup> of 'pierced lace'

Discussion:

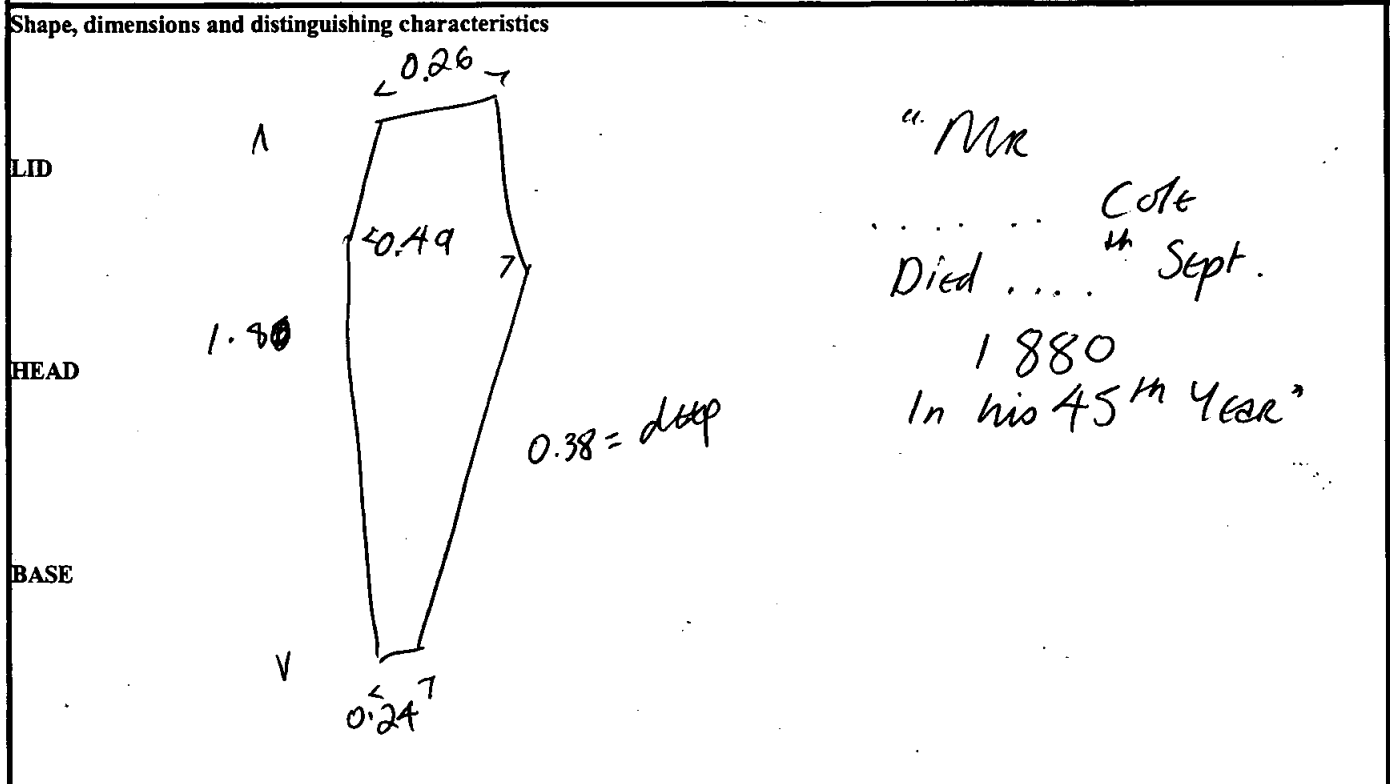
Recorder: SM Date: 12.6.00 Initials:

db

SITE QLR00	COFFIN RECORD SHEET	CONTEXT NO. 623
Trench:	Additional sheets:	Treatment: BONES / DNA
Site sub-div: CAMP BAN 3.	Grave fills:	
Plan no: 7	Grave cut:	Finds None <input checked="" type="checkbox"/>
Section no:	Skeleton:	Breastplate <input checked="" type="checkbox"/> Grip <input checked="" type="checkbox"/>
Co-ordinates:	Matrix location: UNDER 603	Hinge Bracket
Levels:	Preservation: Breached/Corroded	Fixing nails Shroud pins
Slide No.:	Neg No.:	Fabric Other finds

**Description** Pb Coffin

**Discussion**

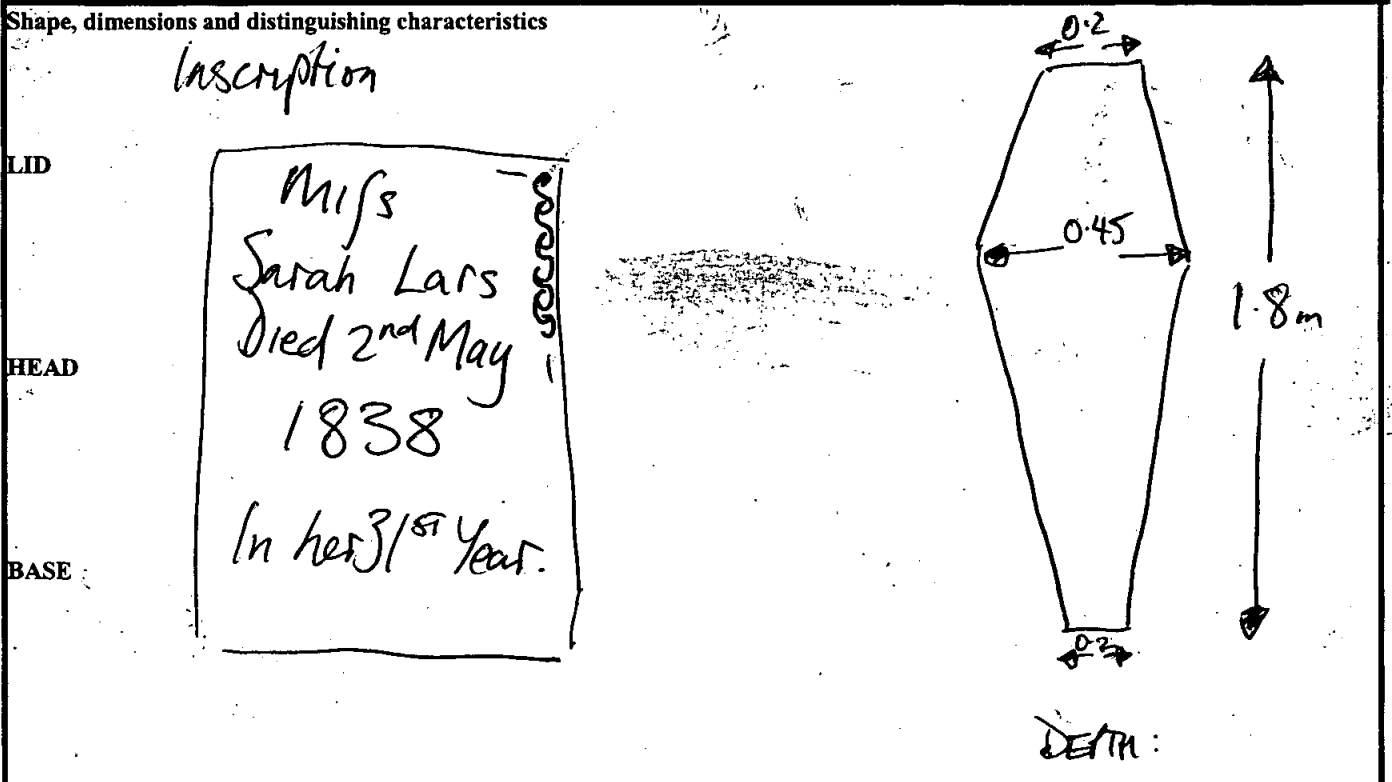

Recorder: M	Date: 17.10.00	Initials:
----------------	-------------------	-----------

db

SITE OLROO	COFFIN RECORD SHEET	CONTEXT NO. 624
Trench:	Additional sheets:	Treatment: <del>WOOD</del> BRICKS LIFTED
Site sub-div: CHURCH BAY 3.	Grave fills:	
Plan no: 7	Grave cut:	Finds None ✓
Section no:	Skeleton:	Breastplate Grip
Co-ordinates:	Matrix location: UNDER 533/534	Hinge Bracket
Levels:	Preservation: BRICKS / CORRODED.	Fixing nails Shroud pins
Slide No.:	Neg No.:	Fabric Other finds

Description  
Pb Coffin - UNNAMED

Discussion

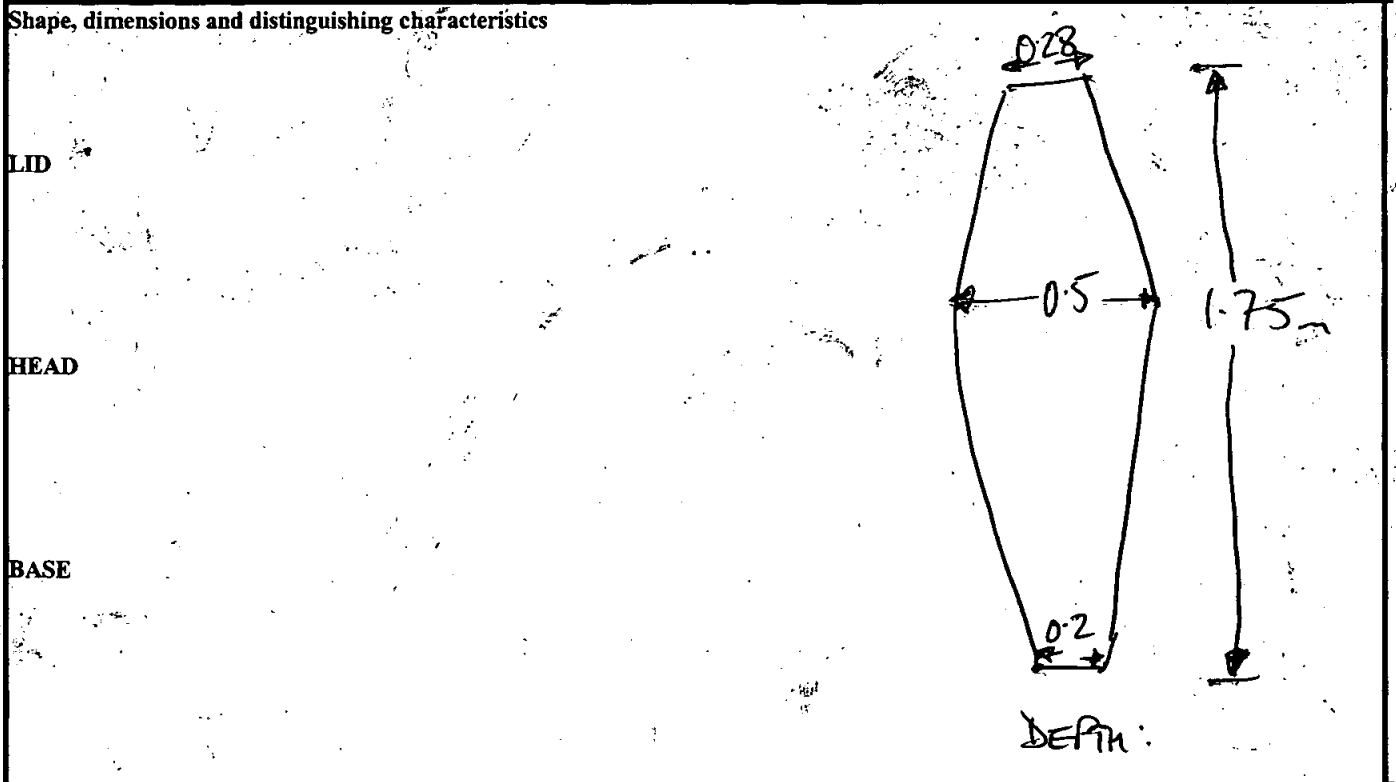

Recorder: <i>TH</i>	Date: 17.10.00	Initials:
---------------------	----------------	-----------

db

SITE 82160	COFFIN RECORD SHEET	CONTEXT NO. 625
Trench:	Additional sheets:	Treatment: INTACT
Site sub-div: CAMP BAN 3	Grave fills	
Plan no: 7.	Grave cut:	Finds None ✓
Section no:	Skeleton:	Breastplate Grip
Co-ordinates:	Matrix location: UNDER 626.	Hinge Bracket
Levels	Preservation: INTACT	Fixing nails Shroud pins
Slide No.	Neg No:	Fabric Other finds

Description: 16 Coffin

Discussion:

Shape, dimensions and distinguishing characteristics

Inscription: -  
Miss  
Zara Turner  
Died 20<sup>th</sup> July  
1790  
Aged 24 Years.

DEPTH: 0.30

Recorder: JM Date: 17.10.00 Initials:

db

SITE	COFFIN RECORD SHEET	CONTEXT NO.
02100		626
Trench:	Additional sheets: YES X 1	Treatment:
Site sub-div: CAMPT BAN3	Grave fills	
Plan no: 7	Grave cut:	Finds
		None
Section no:	Skeleton:	Breastplate ✓
		Grip
Co-ordinates:	Matrix location: UNDER 351 OVER 625.	Hinge
		Bracket
Levels	Preservation: Corroded etc.	Fixing nails
		Shroud pins
Slide No.	Neg No:	Fabric
		Other finds

**Description** Pb Coffin - Lead Breast Plate (Outer Coffin) Mrs Sophia Louch  
**Discussion** Died 16<sup>th</sup> Aug<sup>t</sup> 1847  
 In her 79<sup>th</sup> Year

**Shape, dimensions and distinguishing characteristics**

**LID**

**HEAD**

**BASE**

Inscription: -  
 Mrs  
 Sophia Louch  
 Died 16<sup>th</sup> August  
 1847  
 In her 79<sup>th</sup> Year.

DEATH: 0.3.2

Recorder: Jm Date: 17.10.00 Initials:



# Coffin Recording Sheet

Site Code

Context

**Outer Coffin**

Sample Ret.

Ohloo

626

Recording Date ..... 13/10 .....

Associated Numbers .....

Condition .....

Dep. Plate

Legible

Inscription "Mrs Sophia Louch / Died 6<sup>th</sup> Aug<sup>r</sup> / 1847 / In her 79<sup>th</sup> Year"

Fabric lead  ormolou  brass  tin plated pewter  gilt tin   
 iron  silvered tin  enamelled  other ..... Sample Ret.   
*Black enamelled*

**Shape of dep. plate**

square  rectangle  shield  tapered  lozenge   
 cartouche  oval  other ..... *(2) w/ inner border 618 outer border 534*

**Upholstery**

colour ..... shoddy  velvet  other ..... Sample Ret.

**Construction**

butt joint  mitred  pitched  other .....

Grip plate  Fabric = ormolou  brass  tin plated pewter  gilt tin   
 iron  silvered tin  enamelled  other ..... Sample Ret.

Grip  Fabric = ormolou  brass  iron  Sample Ret.

Design swag of rose  horseshoe  cherub's head  plain   
 other .....

Grip bolts  Corner bolts  Type = gilt brass  brass  iron   
 other ..... Sample Ret.

Lid motifs  other ..... Sample Ret.

Escutcheons  other ..... Sample Ret.

Upholstery nails  brass  gilt brass  silvered brass  iron  enamelled   
 other ..... Sample Ret.

Fixings  panel nails  screws  hinges  lace  Sample Ret.

Timber type ..... Sample Ret.

**Interpretation / Comments**

.....  
 .....

db

SITE 02/200	COFFIN RECORD SHEET	CONTEXT NO. 627
Trench:	Additional sheets:	Treatment: BONES (SKULL FRAGS) NO NAME.
Site sub-div: CRIFT BAY 3.	Grave fills:	
Plan no: 7	Grave cut:	Finds None
Section no:	Skeleton: - POOR CONDITION - ONLY SKULL FRAGS	Breastplate Grip
Co-ordinates:	Matrix location:	Hinge Bracket
Levels:	Preservation: POOR - V. CORRODED.	Fixing nails Shroud pins
Slide No.:	Neg No.:	Fabric Other finds

Description Pb Coffin - Branched Skeleton - V. POOR SURVIVAL.

Discussion NO NAME

Shape, dimensions and distinguishing characteristics

LID

HEAD

BASE

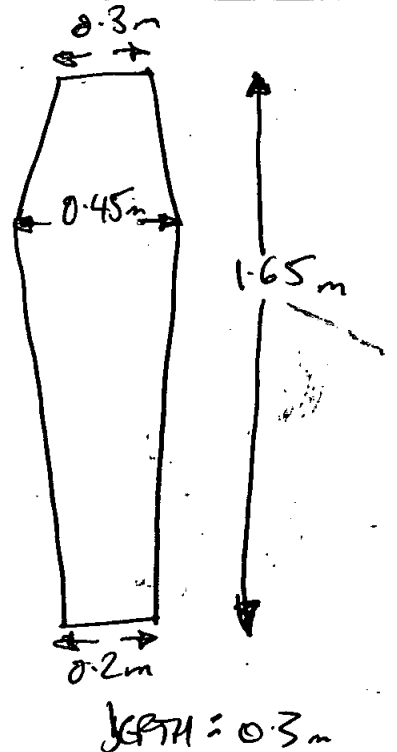

Recorder: <i>[Signature]</i>	Date: 17.10.00	Initials:
------------------------------	----------------	-----------

db

SITE 02100	COFFIN RECORD SHEET	CONTEXT NO. 628
Trench:	Additional sheets:	Treatment: DNA BONES/TEETH BONES LIFTED.
Site sub-div: BAN 3.	Grave fills:	
Plan no: 7.	Grave cut:	Finds None
Section no:	Skeleton: 1000	Breastplate - INSCRIPTION Grip
Co-ordinates:	Matrix location:	Hinge Bracket
Levels:	Preservation: POOR	Fixing nails Shroud pins
Slide No.:	Neg No.:	Fabric Other finds

Description Pb Coffin. - DECORATED WITH CROSS HATCHING. -

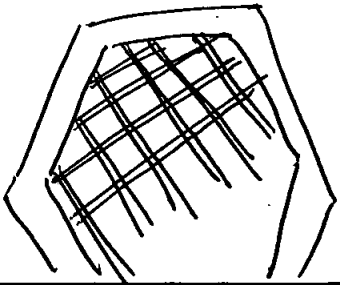

Discussion

Shape, dimensions and distinguishing characteristics

INSCRIPTION:-  
 LID Mr  
 Thomas Moore  
 DIED 15<sup>th</sup> Dec<sup>r</sup>  
 1826  
 BASE Aged 81 yrs

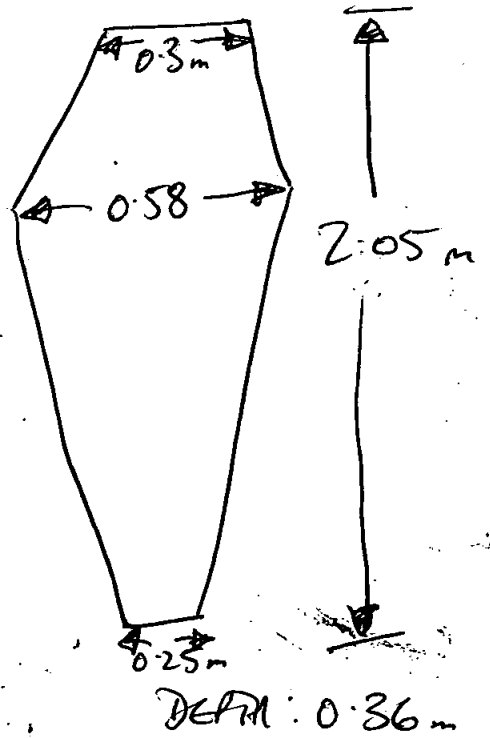

Recorder: <i>Am</i>	Date: 17.10.00.	Initials:
---------------------	-----------------	-----------

dp

SITE OLR00	COFFIN RECORD SHEET	CONTEXT NO. 629
Trench:	Additional sheets:	Treatment: DNA/bones
Site sub-div: CANT BAN 3.	Grave fills:	
Plan no: 7	Grave cut:	Finds None
Section no:	Skeleton: good (except skull)	Breastplate Grip
Co-ordinates:	Matrix location:	Hinge Bracket
Levels:	Preservation: Poor v. Badly Corroded.	Fixing nails Shroud pins
Slide No.:	Neg No.:	Fabric Other finds

**Description**      Poss' wood shavings in coffin.

**Discussion**      Lead coffin

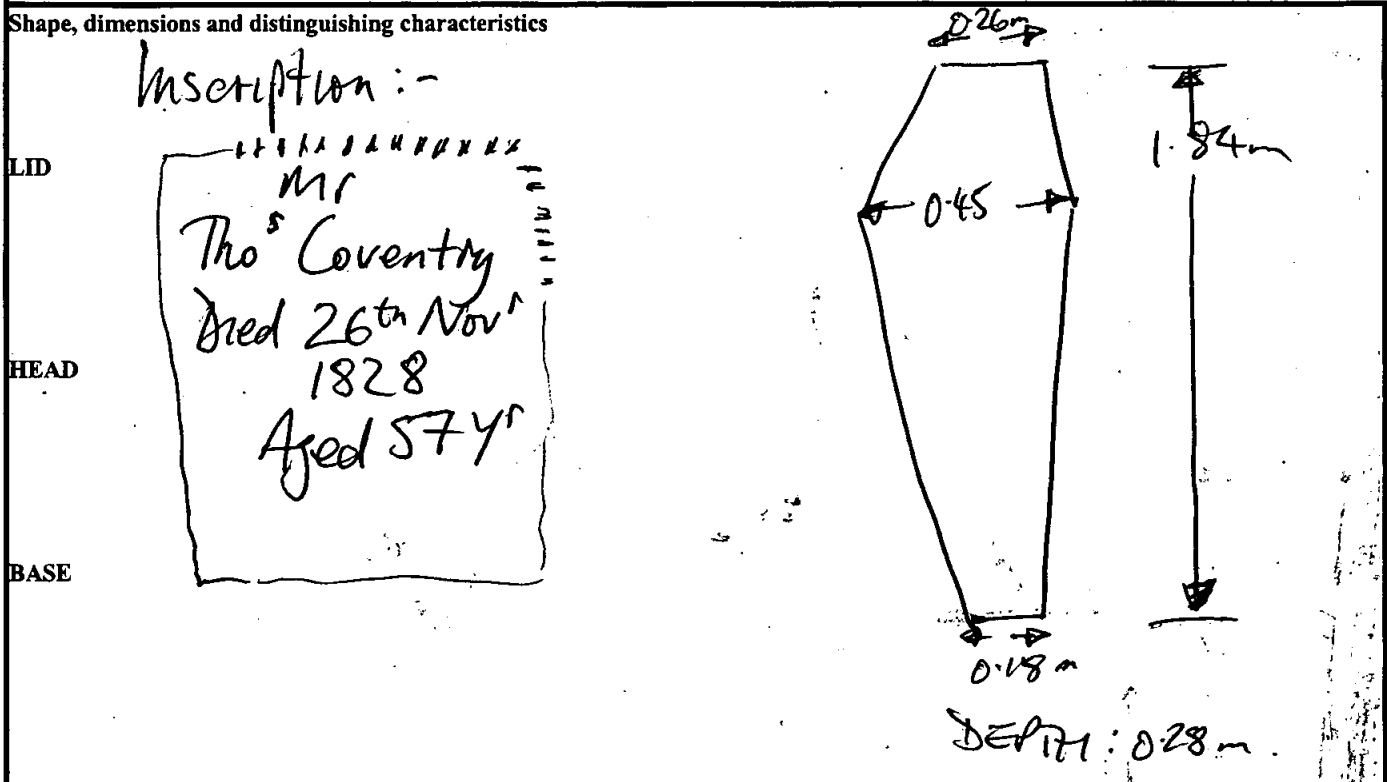

Recorder: M	Date: 17.10.00.	Initials:
----------------	--------------------	-----------

Islington, Old Street, St Lukes  
area

Box 3 File 2

B. PRIMARY CONTACT RECORDS - NO 630-761

SCAN PDF

FILMING INSTRUCTIONS

Submitter OASouth:

No. of CD copies: 2

Headings

Site information

Line 1: [OASouth] County:[Greater London] Parish:[Islington] Site:[Old Street, St Lukes]

Site code[OLR00]

Line 2: Excavators name[A. Boyle]

Line 3:

Classification of material

Tick if present

Classification of material	Tick if present
Index to archive	
Introduction	
A:Final Report	
A:Publication Report	
B:Site Data – Text: Diary/Daybook/Fieldnotes	
B: Site Data – Text: General Summaries	
B: Site Data – Text: Primary Context Records <i>Nº 630 → 761</i>	✓
B: Site Data – Text: Synthesised Context Records	
B: Site Data – Text: Survey Reports	
B: Site Data – Text: Catalogue of Drawings	
B: Site Data – Text: Primary Drawings	
B: Site Data – Text: Synthesised Drawings	
C: Finds Data – Text: Primary Finds Data	
C: Finds Data – Text: Synthesised Finds Data	
C: Finds Data – Text: Specialist Reports	
C: Finds Data – Text: Box/Bag List	
D: Catalogue of Photos/Slides/Videos/X--rays	
E: Environmental/Ecofact Data: Primary Records	
E: Environmental/Ecofact Data: Synthesised Records	
E: Environmental/Ecofact Data: Specialist Reports	
F: Documentary	
F: Press and Publicity	
G: Correspondence	
H: Miscellaneous	

SITE OLR 00		CONTEXT			SITE ST LUKE'S CHURCH			
CODE:		CHECKLIST			NAME: ISLINGTON.			
Context No	Type	Excavated with Segments	Relationships	Dug	Drawn		Matrix (JAMES)	Comments
					Section	Plan		
B 630	BURIAL	NC	UIL 596 UIL 631	OH/AN DHC		3		ADULT
B 631	"	"	UIL 630	"		3		ADULT
B 632	"	"	UIL 633	"		3		JUVENILE
B 633	"	"	UIL 632 UIL 633	"		3		ADULT
B 634	"	"	UIL 635	"		3		ADULT
B 635	"	"	UIL 634	"		3		ADULT
B 636	"	"	<del>UIL 638</del> UIL 633	"		3		ADULT
B 637	"	"	UIL 633					ADULT
B 638	"		UIL 634					ADULT
B 639	"		UIL 640					ADULT
B 640	"		UIL 639 UIL 641					ADULT
B 641	"		UIL 640 UIL 642					ADULT
B 642	"		UIL 641 UIL 642					ADULT
B 643	"		UIL 642					ADULT
B 644	"							ADULT
B 645	"		UIL 646					BABY
B 646	"		UIL 645					ADOLESCENT
B 647	"							ADULT
B 648	"		UIL 649					ADULT
B 649	"		UIL 648 UIL 650					ADULT?
B 650	"		UIL 649					ADULT
B 651	"		UIL 652					ADULT
B 652	"		UIL 651					ADULT
B 653	"		UIL 654					ADULT
B 654	"		UIL 657					ADULT
B 655	"		UIL 656					ADULT - LEAD
B 656	"		UIL 655 UIL 657					ADULT - LEAD (OPIN)
B 657	"		UIL 656					" "
B 658	"		UIL 659 UIL 657					BABY
B 659	"		UIL 658 UIL 659					ADULT
B 660	"		UIL 661					ADULT
B 661	"		UIL 660					CHILD
B 662	"		UIL 663					ADULT

SITE <i>OLR 00</i>		CONTEXT			SITE <i>ST LUKE'S CHURCH</i>		Matrix	Comments
CODE:		CHECKLIST			NAME: <i>ISLINGTON</i>			
Context No.	Type	Excavated with Segments	Relationships	Dug	Drawn			
					Section	Plan		
<i>3</i> 662	<i>BURIAL</i>	<i>NC</i>	<i>U/L 662</i>	<i>DRY</i>		<i>3</i>		<i>ADULT</i>
<i>3</i> 664	<i>"</i>	<i>NC</i>	<i>O/L 664</i>	<i>"</i>		<i>3</i>		<i>ADULT</i>
<i>3</i> 665	<i>"</i>	<i>"</i>	<i>O/L 665</i>	<i>"</i>				<i>Adult</i>
<i>B</i> 666	<i>"</i>	<i>"</i>	<i>U/L 665 665</i>					<i>ADULT</i>
<i>B</i> 667	<i>"</i>	<i>"</i>	<i>U/L 665 666</i>					<i>ADULT</i>
<i>B</i> 668	<i>"</i>	<i>"</i>	<i>O/L 665 667</i>					<i>ADULT</i>
<i>B</i> 669	<i>"</i>	<i>"</i>	<i>U/L 665 668</i>					<i>ADULT</i>
<i>B</i> 670	<i>STR.</i>		<i>U/L 664</i>					<i>WELL/STAIRWAY STRUCTURE</i>
<i>B</i> 671	<i>BURIAL</i>		<i>IN STRUCT 557</i>					<i>Adult</i>
<i>B</i> 672	<i>BURIAL</i>		<i>" " "</i>					<i>Adult</i>
<i>B</i> 673	<i>"</i>		<i>O/L 674</i>					<i>ADULT</i>
<i>B</i> 674	<i>"</i>		<i>U/L 673</i>					<i>ADULT</i>
<i>B</i> 675	<i>"</i>		<i>S/L 675</i>					<i>Adult</i>
<i>B</i> 676	<i>"</i>		<i>U/L 674</i>					<i>Adult</i>
<i>B</i> 677	<i>"</i>		<i>O/L 678</i>					<i>ADULT</i>
<i>B</i> 678	<i>"</i>		<i>NONE</i>					<i>ADULT</i>
<i>B</i> 679	<i>"</i>		<i>U/L 678</i>					<i>ADULT</i>
<i>B</i> 680	<i>"</i>		<i>U/L 675</i>					<i>Adult</i>
<i>B</i> 681	<i>"</i>		<i>S/L 677</i>					<i>Adult</i>
<i>B</i> 682	<i>"</i>		<i>O/L 680</i>					<i>Adult</i>
<i>B</i> 683	<i>"</i>		<i>U/L 679</i>					<i>Adult</i>
<i>B</i> 684	<i>"</i>		<i>S/L 681</i>					<i>Adult</i>
<i>B</i> 685	<i>"</i>		<i>O/L 683</i>					<i>ADULT</i>
<i>B</i> 686	<i>"</i>		<i>U/L 682</i>					<i>ADULT</i>
<i>B</i> 687	<i>"</i>		<i>O/L 685</i>					<i>ADOLESCENT</i>
<i>B</i> 688	<i>"</i>		<i>NONE</i>					<i>ADULT</i>
<i>B</i> 689	<i>"</i>		<i>U/L 686</i>					<i>ADULT</i>
<i>B</i> 690	<i>"</i>		<i>O/L 690</i>					<i>ADULT</i>
<i>B</i> 691	<i>"</i>		<i>NONE</i>					<i>ADULT</i>
<i>B</i> 692	<i>"</i>		<i>U/L 688</i>					<i>ADULT</i>
<i>B</i> 693	<i>"</i>		<i>O/L 684</i>					<i>ADULT</i>
<i>B</i> 694	<i>"</i>		<i>U/L 692</i>					<i>ADULT</i>
<i>B</i> 695	<i>"</i>		<i>O/L 693</i>					<i>ADULT</i>
			<i>O/L 729</i>					<i>BABY</i>

BURIALS THIS PAGE = 32.





SITE		CONTEXT		SITE				
ORR 00		CHECKLIST		ST LUKE'S ISLINGTON				
CODE:		Relationships		Drawn		Matrix <i>(marked)</i>	Comments	
Context No	Type	Excavated with Segments	Dug	Section	Plan			
B	729	burial	NC	U/L 695	OK/AN		3	BABY
B	730	"	"	"	"	"	"	Adult
B	731	"	"	U/L 729	"	"	"	Adult
B	732	"	"	O/L 733	"	"	"	ADULT
B	733	"	"	U/L 732 O/L 734	"	"	"	ADULT
B	734	"	"	O/L 733	"	"	"	ADULT
B	735	"	"	O/L 736	"	"	"	"
B	736	"	"	O/L 735 O/L 739	"	"	"	"
B	737	"	"	O/L 738	"	"	"	"
B	738	"	"	O/L 737 O/L 740	"	"	"	"
B	739	"	"	O/L 736	"	"	"	"
B	740	"	"	O/L 737	"	"	"	"
B	741	"	"	ON ITS OWN	"	"	"	"
B	742	"	"	O/L 745	"	"	"	"
B	743	"	"	O/L 744	"	"	"	"
B	744	"	"	U/L 743	"	"	"	"
B	745	"	"	U/L 742	"	"	"	"
B	746	"	"	ON OWN U/L 749	"	"	"	"
B	747	"	"	ON OWN	"	"	"	"
B	748	"	"	O/L 748 <del>U/L 748</del>	"	"	"	BABY
B	749	"	"	O/L 748 O/L 746	"	"	"	"
B	750	"	"	U/L 747	"	"	"	ADULT
B	751	"	"	O/L 752	"	"	"	BABY/KID
B	752	"	"	U/L 751	"	"	"	BABY
B	753	"	"	O/L 755	"	"	"	ADULT
B	754	"	"	"	"	"	"	BABY
B	755	"	"	U/L 753 O/L 756	"	"	"	BABY
B	756	"	"	U/L 755 O/L 757	"	"	"	ADULT
B	757	"	"	U/L 756	"	"	"	JUVENILE
B	758	"	"	O/L 759	"	"	"	ADULT
B	759	"	"	U/L 758	"	"	"	ADULT
B	760	"	"	O/L 761	"	"	"	BABY
B	761	"	"	U/L 760 O/L 765	"	"	"	BABY/JUVENILE

BURIALS THIS PAGE = 33

db.

SITE OLK 00	COFFIN RECORD SHEET	CONTEXT NO. <del>347</del> 630
Trench:	Additional sheets: YES x 1	Treatment: BONES COLLECTED
Site sub-div: NC	Grave fills	
Plan no: 3	Grave cut:	Finds None
Section no:	Skeleton:	Breastplate Grip ✓
Co-ordinates:	Matrix location: 596 630	Hinge Bracket
Levels	Preservation: GOOD	Fixing nails Shroud pins
Slide No.	Neg No:	Fabric Other finds

Description E-W ADULT BURIAL

Discussion

Shape, dimensions and distinguishing characteristics

LID

HEAD

BASE

Recorder: <i>BM</i>	Date: 11/10/00	Initials:
---------------------	----------------	-----------

# Coffin Recording Sheet

Site Code

Context

**Outer Coffin**

Sample Ret.

OH200

630

Recording Date ..... 14/12/00 .....

Associated Numbers .....

Condition ..... 1 .....

Dep. Plate

Legible  NO

Inscription *Frgs of Re. dep. plate - unid.*

Fabric lead  ormolou  brass  tin plated pewter  gilt tin   
 iron  silvered tin  enamelled  other ..... Sample Ret.

**Shape of dep. plate**

square  rectangle  shield  tapered  lozenge   
 cartouche  oval  other .....

**Upholstery**

colour ..... shoddy  velvet  other ..... Sample Ret.

**Construction**

butt joint  mitred  pitched  other .....

**Grip plate**

Fabric = ormolou  brass  tin plated pewter  gilt tin   
 iron  x2 silvered tin  228b enamelled  other ..... Sample Ret.   
*(250.19)*

**Grip**

Fabric = ormolou  brass  iron  x2 228a Sample Ret.

**Design**

swag of rose  horseshoe  cherub's head  plain

other .....

**Grip bolts**

Corner bolts  Type = gilt brass  brass  iron

other ..... Sample Ret.

**Lid motifs**

other ..... Sample Ret.

**Escutcheons**

other ..... Sample Ret.

**Upholstery nails**

brass  gilt brass  silvered brass  iron  enamelled

other ..... Sample Ret.

**Fixings**

panel nails  screws  hinges  lace  Sample Ret.

**Timber type**

..... Sample Ret.

**Interpretation / Comments**

.....  
 .....

SITE <i>OLR 00</i>		COFFIN RECORD SHEET	CONTEXT NO. <i>631</i>
Trench:	Additional sheets:	Treatment: <i>BONES COLLECTED</i>	
Site sub-div: <i>NC</i>	Grave fills		
Plan no: <i>3</i>	Grave cut:	Finds None	
Section no:	Skeleton:	Breastplate Grip <input checked="" type="checkbox"/>	
Co-ordinates:	Matrix location: <i>(650)</i> <i>(631)</i>	Hinge Bracket	
Levels	Preservation: <i>Good</i>	Fixing nails Shroud pins	
Slide No.	Neg No:	Fabric Other finds	
Description <i>EDW ADULT BURIAL</i>			
Discussion			
Shape, dimensions and distinguishing characteristics			
LID			
HEAD			
BASE			
Recorder: <i>AM</i>	Date: <i>12/10/00</i>	Initials:	

**Outer Coffin**

Sample Ret.

Site Code

Context

Recording Date ..... 22/2/01 .....

OH200

631

Associated Numbers .....

Condition .....

Dep. Plate

Legible

Inscription

Fabric lead  ormolou  brass  tin plated pewter  gilt tin   
 iron  silvered tin  enamelled  other ..... Sample Ret.

**Shape of dep. plate**

square  rectangle  shield  tapered  lozenge   
 cartouche  oval  other .....

**Upholstery**

colour ..... shoddy  velvet  other ..... Sample Ret.

**Construction**

butt joint  mitred  pitched  other .....

Grip plate  Fabric = ormolou  brass  tin plated pewter  gilt tin   
 iron  <sup>2x 228b.</sup> silvered tin  enamelled  other ..... Sample Ret.

Grip  Fabric = ormolou  brass  iron  <sup>x2</sup> Sample Ret.

Design swag of rose  horseshoe  cherub's head  <sup>228a</sup> plain   
 other .....

Grip bolts  Corner bolts  Type = gilt brass  brass  iron

other ..... Sample Ret.

Lid motifs  other ..... Sample Ret.

Escutcheons  other ..... Sample Ret.

Upholstery nails  brass  gilt brass  silvered brass  iron  enamelled   
 other ..... Sample Ret.

Fixings  panel nails  screws  hinges  lace  Sample Ret.

Timber type ..... Sample Ret.

**Interpretation / Comments**

.....  
 .....

SITE	02R 00	COFFIN RECORD SHEET	CONTEXT NO:	632
Trench:		Additional sheets:	Treatment:	Bones collected.
Site sub-div:	NC	Grave fills	✓	
Plan no:	3	Grave cut:	✓	Finds None
Section no:		Skeleton:	632	Breastplate Grip
Co-ordinates:		Matrix location:	632 633	Hinge Bracket
Levels		Preservation:	GOOD.	Fixing nails Shroud pins
Slide No.		Neg No:		Fabric Other finds

**Description**  
 E-W Juvenile burial, overlying 633. Head truncated away by vault. No body present below spine - assume truncated by later grave which is still under section.

**Discussion**

**Shape, dimensions and distinguishing characteristics**

LID	Extra bones: Sternum Manubrium R Ulna R Radius L Radius R scaploid R lunate R capitate L Trapezium R Trapezoid R Triquetrum R 1-2 Mc R 4-5 Mc 12th thoracic vertebra	From at least 2 individuals. L Radius + 12 vertebra possibly disarticulated. The rest from 633?
HEAD		
BASE		

Recorder:	D. Horn	Date:	10.10.00	Initials:	
-----------	---------	-------	----------	-----------	--

SITE <i>OLR 00</i>	COFFIN RECORD SHEET	CONTEXT NO. <i>633</i>
Trench:	Additional sheets:	Treatment: <i>Bones collected.</i>
Site sub-div: <i>NC</i>	Grave fills <i>/</i>	
Plan no: <i>3</i>	Grave cut: <i>/</i>	Finds None
Section no:	Skeleton: <i>633</i>	Breastplate Grip
Co-ordinates:	Matrix location: <i>632</i> <i>633</i>	Hinge Bracket
Levels	Preservation: <i>FAIR</i>	Fixing nails Shroud pins
Slide No.	Neg No:	Fabric Other finds
<b>Description</b> <i>E-W Adult burial. Only top 1/2 remaining. Skull etc truncated by vault to west, legs etc partly trunc. by later burial (see 632).</i>		
<b>Discussion</b>		
<b>Shape, dimensions and distinguishing characteristics</b>  <b>LID</b>  <b>HEAD</b>  <b>BASE</b>		
Recorder: <i>D. Ham</i>	Date: <i>11.18.00</i>	Initials:



SITE	COFFIN RECORD SHEET	CONTEXT NO.
OLR 00		634
Trench:	Additional sheets: <i>ves x 1</i>	Treatment:
Site sub-div: <i>NC</i>	Grave fills	<i>BONES COVERED</i>
Plan no: <i>3</i>	Grave cut:	Finds None
Section no:	Skeleton:	Breastplate Grip <input checked="" type="checkbox"/>
Co-ordinates:	Matrix location: <i>634</i> <i>635</i>	Hinge Bracket
Levels	Preservation: <i>AVERAGE</i>	Fixing nails Shroud pins
Slide No.	Neg No:	Fabric Other finds
<b>Description</b> <i>E-W ADULT BURIAL - ONLY ARTICULATED LEFT ARM FOUND  - TRUNCATED BY MACHINE?</i>		
<b>Discussion</b>		
<b>Shape, dimensions and distinguishing characteristics</b>  LID  HEAD  BASE		
Recorder: <i>GM</i>	Date: <i>11/16/00</i>	Initials:

# Coffin Recording Sheet

Site Code

Context

**Outer Coffin**

Sample Ret.

01200

634

Recording Date ..... 12/2/01 .....

Associated Numbers .....

Condition .....

Dep. Plate

Legible

Inscription

Fabric lead  ormolou  brass  tin plated pewter  gilt tin   
iron  silvered tin  enamelled  other ..... Sample Ret.

**Shape of dep. plate**

square  rectangle  shield  tapered  lozenge   
cartouche  oval  other .....

**Upholstery**

colour ..... shoddy  velvet  other ..... Sample Ret.

**Construction**

butt joint  mitred  pitched  other .....

**Grip plate**

Fabric = ormolou  brass  tin plated pewter  gilt tin   
iron  silvered tin  enamelled  other ..... Sample Ret.   
*fasts on ltr of grip - unid.*

**Grip**

Fabric = ormolou  brass  iron  Sample Ret.   
*x2 36's*

**Design**

swag of rose  horseshoe  cherub's head  plain

other .....

**Grip bolts**

**Corner bolts**  Type = gilt brass  brass  iron

other ..... Sample Ret.

**Lid motifs**

other ..... Sample Ret.

**Escutcheons**

other ..... Sample Ret.

**Upholstery nails**

brass  gilt brass  silvered brass  iron  enamelled

other ..... Sample Ret.

**Fixings**

panel nails  screws  hinges  lace  Sample Ret.

**Timber type**

..... Sample Ret.

**Interpretation / Comments**

.....  
.....

db

SITE	COFFIN RECORD SHEET	CONTEXT NO.
CLR 00	Additional sheets: YES XI.	635 Treatment: Bone collected.
Trench:	Grave fills	
Site sub-div: NC	Grave cut:	Finds None
Plan no: 3	Skeleton:	Breastplate Grip ✓
Section no:	Matrix location: (634) (635)	Hinge Bracket
Co-ordinates:	Preservation: AVERAGE	Fixing nails Shroud pins
Levels	Slide No.	Neg No: Fabric
Slide No.	Neg No:	Other finds
<p><b>Description</b> E-W ADULT BURIAL - SPINE &amp; LEFT SIDE OF UPPER BODY FOUND - TRUNCATED BY (634)?</p> <p><b>Discussion</b> POSSIBLY CONTAINS LOWER VERTEBRAS OF 634 TWO SETS. 1 SET T10 T11 &amp; T12 and T12 L1 LOTS of OSTEOPHYTES</p>		
<p>Shape, dimensions and distinguishing characteristics</p> <p>LID</p> <p>HEAD</p> <p>BASE</p>		
Recorder: BM	Date: 11/10/00	Initials:

# Coffin Recording Sheet

Site Code

Context

**Outer Coffin**

Sample Ret.

02200

635

Recording Date ..... 14/12/00 .....

Associated Numbers .....

Condition .....

Dep. Plate

Legible

Inscription

Fabric lead       ormolou       brass       tin plated pewter       gilt tin   
 iron       silvered tin       enamelled       other .....      Sample Ret.

**Shape of dep. plate**

square       rectangle       shield       tapered       lozenge   
 cartouche       oval       other .....

**Upholstery**

colour .....      shoddy       velvet       other .....      Sample Ret.

**Construction**

butt joint       mitred       pitched       other .....

Grip plate  Fabric = ormolou       brass       tin plated pewter       gilt tin   
 iron  *Feeds on rev. of grip-wood.*      silvered tin       enamelled       other .....      Sample Ret.

Grip  Fabric = ormolou       brass       iron  *x3*      Sample Ret.

Design      swag of rose       horseshoe       cherub's head       *Ⓟ* plain   
 other .....

Grip bolts       Corner bolts       Type =      gilt brass       brass       iron   
 other .....      Sample Ret.

Lid motifs       other .....

Escutcheons       other .....

Upholstery nails       brass       gilt brass       silvered brass       iron       enamelled   
 other .....      Sample Ret.

Fixings       panel nails       screws       hinges       lace       Sample Ret.

Timber type .....      Sample Ret.

**Interpretation / Comments**

.....  
 .....

SITE <i>Old 00</i>		COFFIN RECORD SHEET	CONTEXT NO. <i>636</i>
Trench:	Additional sheets:	Treatment: <i>BOVER COLLECTED</i>	
Site sub-div: <i>NC</i>	Grave fills		
Plan no: <i>3</i>	Grave cut:	Finds	
		None	
Section no:	Skeleton:	Breastplate	
		Grip <input checked="" type="checkbox"/>	
Co-ordinates:	Matrix location: <i>(636)</i>	Hinge	
		Bracket	
Levels	Preservation:	Fixing nails	
		Shroud pins	
Slide No.	Neg No:	Fabric	
		Other finds	
Description <i>E-W ADULT BURIAL</i>			
Discussion			
Shape, dimensions and distinguishing characteristics			
LID			
HEAD			
BASE			
Recorder: <i>BM/DH</i>	Date: <i>11/10/00</i>	Initials:	

# Coffin Recording Sheet

Site Code

Context

**Outer Coffin**

Sample Ret.

OLR00

636

Recording Date ..... 19/2/01

Associated Numbers .....

Condition .....

Dep. Plate

Legible

Inscription

Fabric lead  ormolou  brass  tin plated pewter  gilt tin   
 iron  silvered tin  enamelled  other ..... Sample Ret.

**Shape of dep. plate**

square  rectangle  shield  tapered  lozenge   
 cartouche  oval  other .....

**Upholstery**

colour ..... shoddy  velvet  other ..... Sample Ret.

**Construction**

butt joint  mitred  pitched  other .....

**Grip plate**

Fabric = ormolou  brass  tin plated pewter  gilt tin   
*rogs on rev of grip - unid*  
 iron  silvered tin  enamelled  other ..... Sample Ret.

**Grip**

Fabric = ormolou  brass  iron  Sample Ret.

**Design**

swag of rose  horseshoe  cherub's head  plain   
 other ..... 3 x 30's 2 x 1's

**Grip bolts**

**Corner bolts**  Type = gilt brass  brass  iron

other ..... Sample Ret.

**Lid motifs**

other ..... Sample Ret.

**Escutcheons**

other ..... Sample Ret.

**Upholstery nails**

brass  gilt brass  silvered brass  iron  enamelled

other ..... Sample Ret.

**Fixings**

panel nails  screws  hinges  lace  Sample Ret.

**Timber type**

..... Sample Ret.

**Interpretation / Comments**

.....  
 .....

SITE <i>OLR 00</i>		COFFIN RECORD SHEET	CONTEXT NO. <i>637</i>
Trench:	Additional sheets:	Treatment: <i>Bone collected</i>	
Site sub-div: <i>NC</i>	Grave fills: <i>/</i>		
Plan no: <i>3</i>	Grave cut: <i>/</i>	Finds None	
Section no:	Skeleton: <i>637</i>	Breastplate Grip	
Co-ordinates:	Matrix location: <i>633</i> <i>637</i>	Hinge Bracket	
Levels	Preservation: <i>FAIR</i>	Fixing nails Shroud pins	
Slide No.	Neg No:	Fabric Other finds	
<b>Description</b> <i>E-W Adult/Adolescent burial - truncated by vault + legs missing, same as 632+633 - truncated by another grave, it seems.</i>			
<b>Discussion</b>			
<b>Shape, dimensions and distinguishing characteristics</b>			
<b>LID</b>			
<b>HEAD</b>			
<b>BASE</b>			
Recorder:	Date:	Initials:	

SITE <i>OLK 00</i>		COFFIN RECORD SHEET	CONTEXT NO. <i>638</i>
Trench:	Additional sheets: <i>YES x1</i>	Treatment: <i>DONE CONCRETE</i>	
Site sub-div: <i>NC</i>	Grave fills		
Plan no: <i>3</i>	Grave cut:	Finds None	
Section no:	Skeleton: <i>638</i>	Breastplate Grip <input checked="" type="checkbox"/>	
Co-ordinates:	Matrix location: <i>(636)</i> <i>(638)</i>	Hinge Bracket	
Levels	Preservation:	Fixing nails Shroud pins	
Slide No.	Neg No:	Fabric Other finds	
Description <i>E-W ADULT BURIAL</i>			
Discussion			
Shape, dimensions and distinguishing characteristics			
LID			
HEAD			
BASE			
Recorder: <i>DKA/DH</i>	Date: <i>12/10/00</i>	Initials:	



Site Code

Context

**Outer Coffin**

Sample Ret.

OKR00

638

Recording Date ..... 13/2/01

Associated Numbers .....

Condition .....

Dep. Plate

Legible

Inscription

Fabric lead  ormolou  brass  tin plated pewter  gilt tin   
 iron  silvered tin  enamelled  other ..... Sample Ret.

**Shape of dep. plate**

square  rectangle  shield  tapered  lozenge   
 cartouche  oval  other .....

**Upholstery**

colour ..... shoddy  velvet  other *Boize* ..... Sample Ret.

**Construction**

butt joint  mitred  pitched  other .....

**Grip plate**

*Fabric = ormolou*  brass  tin plated pewter  gilt tin   
*Progn on dev. of grip - unid.*  
 iron  silvered tin  enamelled  other ..... Sample Ret.

**Grip**

*Fabric = ormolou*  brass  iron  *X2* Sample Ret.   
*too conc. to id*

**Design**

swag of rose  horseshoe  cherub's head  plain

other .....

**Grip bolts**

**Corner bolts**  Type = gilt brass  brass  iron

other ..... Sample Ret.

**Lid motifs**

other ..... Sample Ret.

**Escutcheons**

other ..... Sample Ret.

**Upholstery**

*studs*  
 nails  brass  gilt brass  silvered brass  iron  enamelled   
 other ..... *4 x pieces / 1 x [diagram] = 23 studs / 1 x [diagram] = 5 studs* Sample Ret.   
*1 x [diagram] = 15 studs TOTAL 55.*

**Fixings**

panel nails  screws  hinges  lace  Sample Ret.

**Timber type** .....

Sample Ret.

**Interpretation / Comments**

.....  
 .....

db

SITE	OLR 00	COFFIN RECORD SHEET	CONTEXT NO.	639	
Trench:		Additional sheets:	YES x1	Treatment:	BONE COLLECTED
Site sub-div:	NC	Grave fills			
Plan no:	3	Grave cut:		Finds	None
Section no:		Skeleton:	639	Breastplate	Grip <input checked="" type="checkbox"/>
Co-ordinates:		Matrix location:	639 640	Hinge	
Levels		Preservation:	fair	Bracket	
Slide No.		Neg No:		Fixing nails	
				Shroud pins	
				Fabric	
				Other finds	

Description E-W ADULT BURIAL - CUT BY LATER PIT?, TAIL ~~ON~~ TOP  
 HALF OF TORSO NOT PRESENT.

Discussion

Shape, dimensions and distinguishing characteristics

LID

HEAD

BASE

Recorder:	DM / DM	Date:	12/10/00	Initials:	
-----------	---------	-------	----------	-----------	--

**Outer Coffin**

Sample Ret.

Site Code

Context

Recording Date ..... *12/12/00* .....

*Orl00*

*639*

Associated Numbers .....

Condition .....

Dep. Plate

Legible

Inscription

Fabric lead  ormolou  brass  tin plated pewter  gilt tin   
 iron  silvered tin  enamelled  other ..... Sample Ret.

**Shape of dep. plate**

square  rectangle  shield  tapered  lozenge   
 cartouche  oval  other .....

**Upholstery**

colour ..... shoddy  velvet  other ..... Sample Ret.

**Construction**

butt joint  mitred  pitched  other .....

**Grip plate**

Fabric = ormolou  brass  tin plated pewter  gilt tin   
*knags on rev of grip-und*  
 iron  silvered tin  enamelled  other ..... Sample Ret.

**Grip**

Fabric = ormolou  brass  iron  *X2* Sample Ret.   
*some w 2280*

**Design**

swag of rose  horseshoe  cherub's head  plain

other .....

**Grip bolts**

**Corner bolts**  Type = gilt brass  brass  iron

other ..... Sample Ret.

**Lid motifs**

other ..... Sample Ret.

**Escutcheons**

other ..... Sample Ret.

**Upholstery nails**

brass  gilt brass  silvered brass  iron  enamelled

other ..... Sample Ret.

**Fixings**

panel nails  screws  hinges  lace  Sample Ret.

**Timber type** .....

Sample Ret.

**Interpretation / Comments**

.....  
 .....

SITE <u>OLR 00</u>		COFFIN RECORD SHEET	CONTEXT NO. <u>640</u>
Trench:	Additional sheets:	Treatment: <u>BONE COLLECTED</u>	
Site sub-div: <u>NC</u>	Grave fills		
Plan no: <u>3</u>	Grave cut:	Finds None	
Section no:	Skeleton: <u>640</u>	Breastplate Grip	
Co-ordinates:	Matrix location: <u>(639)</u> <u>(640)</u> <u>(641)</u>	Hinge Bracket	
Levels	Preservation: <u>AV.</u>	Fixing nails Shroud pins	
Slide No.	Neg No:	Fabric Other finds	
Description <u>E-W ADULT BURIAL TRUNCATED BY BURIAL (639). ONLY LEFT SIDE OF BURIAL REMAINS.</u>			
Discussion			
Shape, dimensions and distinguishing characteristics			
LID			
HEAD			
BASE			
Recorder: <u>JBM/dn</u>	Date: <u>12/10/00</u>	Initials:	

SITE <u>OLR 00</u>		COFFIN RECORD SHEET	CONTEXT NO. <u>641</u>
Trench:	Additional sheets:	Treatment: <u>None collected</u>	
Site sub-div: <u>NC</u>	Grave fills		
Plan no: <u>3</u>	Grave cut:	Finds None	
Section no:	Skeleton: <u>641</u>	Breastplate Grip	
Co-ordinates:	Matrix location <u>(640)</u> <u>(641)</u> <u>(642)</u>	Hinge Bracket	
Levels	Preservation: <u>AV.</u>	Fixing nails Shroud pins	
Slide No.	Neg No:	Fabric Other finds :	
Description <u>E-W ADULT BURIAL.</u>			
Discussion			
Shape, dimensions and distinguishing characteristics			
<p>LED</p> <p>HEAD</p> <p>BASE</p>			
Recorder: <u>AM/DH</u>	Date: <u>12/10/00</u>	Initials:	

**Outer Coffin**

Sample Ret.

Site Code

Context

Recording Date ..... 19/2/01

06200

641

Associated Numbers .....

Condition .....

Dep. Plate

Legible

Inscription

Fabric lead  ormolou  brass  tin plated pewter  gilt tin   
iron  silvered tin  enamelled  other ..... Sample Ret.

**Shape of dep. plate**

square  rectangle  shield  tapered  lozenge   
cartouche  oval  other .....

**Upholstery**

colour ..... shoddy  velvet  other ..... Sample Ret.

**Construction**

butt joint  mitred  pitched  other .....

Grip plate  Fabric = ormolou  brass  tin plated pewter  gilt tin   
iron  *Frogson REV. of grip - unid* silvered tin  enamelled  other ..... Sample Ret.

Grip  Fabric = ormolou  brass  iron  x1 Sample Ret.

Design swag of rose  horseshoe  cherub's head  (36) plain   
other .....

Grip bolts  Corner bolts  Type = gilt brass  brass  iron

other ..... Sample Ret.

Lid motifs  other ..... Sample Ret.

Escutcheons  other ..... Sample Ret.

Upholstery nails  brass  gilt brass  silvered brass  iron  enamelled

other ..... Sample Ret.

Fixings  panel nails  screws  hinges  lace  Sample Ret.

Timber type ..... Sample Ret.

**Interpretation / Comments**

.....  
.....

SITE <u>042 00</u>		COFFIN RECORD SHEET	CONTEXT NO. <u>642</u>
Trench:	Additional sheets:	Treatment: <u>BONE COLLECTED</u>	
Site sub-div: <u>NC</u>	Grave fills		
Plan no: <u>3</u>	Grave cut:	Finds None	
Section no:	Skeleton: <u>642</u>	Breastplate Grip <input checked="" type="checkbox"/>	
Co-ordinates:	Matrix location: <u>641</u> <u>642</u>	Hinge Bracket	
Levels	Preservation: <u>9000.</u>	Fixing nails Shroud pins	
Slide No.	Neg No:	Fabric Other finds :	

Description EAW ADULT BURIAL

Discussion

Shape, dimensions and distinguishing characteristics

LID

HEAD

BASE

Recorder: AWY/01

Date: 12/10/00

Initials:

**Outer Coffin**

Sample Ret.

Site Code

Context

Recording Date ..... 21/2/01 .....

01200

642

Associated Numbers .....

Condition .....

Dep. Plate

Legible

Inscription

Fabric lead  ormolou  brass  tin plated pewter  gilt tin   
 iron  silvered tin  enamelled  other ..... Sample Ret.

**Shape of dep. plate**

square  rectangle  shield  tapered  lozenge   
 cartouche  oval  other .....

**Upholstery**

colour ..... shoddy  velvet  other baize ..... Sample Ret.

**Construction** butt joint  mitred  pitched  other .....

**Grip plate**  Fabric = ormolou  brass  tin plated pewter  gilt tin   
 iron  silvered tin  enamelled  other ..... Sample Ret.

**Grip**  Fabric = ormolou  brass  iron  Sample Ret.

**Design** swag of rose  horseshoe  cherub's head  plain   
 other .....

**Grip bolts**  **Corner bolts**  Type = gilt brass  brass  iron   
 other ..... Sample Ret.

**Lid motifs**  other ..... Sample Ret.

**Escutcheons**  other ..... Sample Ret.

**Upholstery** <sup>studs</sup> ~~nails~~  brass  gilt brass  silvered brass  iron  enamelled   
 other 5x rivets 1x 00000 / 1x 000000 / 1x 000000 / 1x 000000 / 1x 000000 / 1x 00000000 ..... Sample Ret.   
= 46 studs.

**Fixings**  panel nails  screws  hinges  lace  Sample Ret.

**Timber type** ..... Sample Ret.

**Interpretation / Comments**

.....  
 .....



110.

SITE 04K 00	COFFIN RECORD SHEET	CONTEXT NO. 643
Trench:	Additional sheets: YES x 1.	Treatment: Bone collected
Site sub-div: NC	Grave fills	
Plan no: 3	Grave cut:	Finds None
Section no:	Skeleton: 643	Breastplate Grip
Co-ordinates:	Matrix location: 642 643	Hinge Bracket
Levels	Preservation:	Fixing nails Shroud pins
Slide No.	Neg No:	Fabric Other finds
Description E-W ADULT BURIAL		
Discussion		
Shape, dimensions and distinguishing characteristics		
LID		
HEAD		
BASE		
Recorder: [Signature]	Date: 12/10/00	Initials:

# Coffin Recording Sheet

Site Code

Context

**Outer Coffin**

Sample Ret.

Orloo

643

Recording Date ..... 13/12/00

Associated Numbers .....

Condition .....

Dep. Plate

Legible

Inscription

Fabric lead  ormolou  brass  tin plated pewter  gilt tin   
 iron  silvered tin  enamelled  other ..... Sample Ret.

**Shape of dep. plate**

square  rectangle  shield  tapered  lozenge   
 cartouche  oval  other .....

**Upholstery**

colour ..... shoddy  velvet  other ..... Sample Ret.

**Construction**

butt joint  mitred  pitched  other .....

Grip plate  Fabric = ormolou  brass  tin plated pewter  gilt tin   
 iron  *frags on the rev of grip-wood.* silvered tin  enamelled  other ..... Sample Ret.

Grip  Fabric = ormolou  brass  iron  *x2* Sample Ret.

Design swag of rose  horseshoe  cherub's head  *(3b)'s* plain   
 other .....

Grip bolts  Corner bolts  Type = gilt brass  brass  iron   
 other ..... Sample Ret.

Lid motifs  other ..... Sample Ret.

Escutcheons  other ..... Sample Ret.

Upholstery nails  brass  gilt brass  silvered brass  iron  enamelled   
 other ..... Sample Ret.

Fixings  panel nails  screws  hinges  lace  Sample Ret.

Timber type ..... Sample Ret.

**Interpretation / Comments**

.....  
 .....

SITE <i>OLR 00</i>		COFFIN RECORD SHEET		CONTEXT NO. <i>644</i>	
Trench:		Additional sheets:		Treatment:	
Site sub-div: <i>NC</i>		Grave fills <i>/</i>		<i>Bones collected.</i>	
Plan no: <i>3</i>		Grave cut: <i>/</i>		Finds	
Section no:		Skeleton: <i>644</i>		None	
Co-ordinates:		Matrix location:		Breastplate	
Levels		Preservation: <i>FAIR.</i>		Grip	
Slide No.		Neg No:		Hinge	
				Bracket	
				Fixing nails	
				Shroud pins	
				Fabric	
				Other finds	
<p>Description</p> <p><i>E-W Adult burial - only Right side removed due to its being underneath the section at the edge of dig (2-2.5m down).</i></p> <p>Discussion</p>					
<p>Shape, dimensions and distinguishing characteristics</p> <p>LID</p> <p>HEAD</p> <p>BASE</p>					
Recorder: <i>D. H. M.</i>		Date: <i>12.10.00.</i>		Initials:	

Site Code

Context

**Outer Coffin**

Sample Ret.

OLR00

644

Recording Date ..... 16/2/01 .....

Associated Numbers .....

Condition .....

Dep. Plate

Legible

Inscription

Fabric lead  ormolou  brass  tin plated pewter  gilt tin   
 iron  silvered tin  enamelled  other ..... Sample Ret.

**Shape of dep. plate**

square  rectangle  shield  tapered  lozenge   
 cartouche  oval  other .....

**Upholstery**

colour ..... shoddy  velvet  other ..... Sample Ret.

**Construction**

butt joint  mitred  pitched  other .....

Grip plate  Fabric = ormolou  brass  tin plated pewter  gilt tin   
 iron  *Feeds on rev of grip - unid.* silvered tin  enamelled  other ..... Sample Ret.

Grip  Fabric = ormolou  brass  iron  *x3* Sample Ret.

Design swag of rose  horseshoe  cherub's head  *(3b)s* plain   
 other .....

Grip bolts  Corner bolts  Type = gilt brass  brass  iron   
 other ..... Sample Ret.

Lid motifs  other ..... Sample Ret.

Escutcheons  other ..... Sample Ret.

Upholstery nails  brass  gilt brass  silvered brass  iron  enamelled   
 other ..... Sample Ret.

Fixings  panel nails  screws  hinges  lace  Sample Ret.

Timber type ..... Sample Ret.

**Interpretation / Comments**

.....  
 .....

SITE <i>BR 00</i>	COFFIN RECORD SHEET	CONTEXT NO. <i>645</i>
Trench:	Additional sheets:	Treatment: <i>Bones collected..</i>
Site sub-div: <i>NC</i>	Grave fills <i>/</i>	
Plan no: <i>3</i>	Grave cut: <i>/</i>	Finds None
Section no:	Skeleton: <i>645</i>	Breastplate Grip
Co-ordinates:	Matrix location: <i>645</i> <i>646</i>	Hinge Bracket
Levels	Preservation: <i>GOOD.</i>	Fixing nails Shroud pins
Slide No.	Neg No:	Fabric Other finds
<p><b>Description</b> <i>E-W child burial. Buried between (overlying) legs of 646. Buried in quick lime - some horrible disease, no doubt!</i></p> <p><b>Discussion</b></p>		
<p><b>Shape, dimensions and distinguishing characteristics</b></p> <p>LID</p> <p>HEAD</p> <p>BASE</p>		
Recorder: <i>D. HAM</i>	Date: <i>13.10.00.</i>	Initials:

SITE	COFFIN RECORD SHEET	CONTEXT NO.
OLR 00	Additional sheets: YES x 2	646 Treatment: Bones collected.
Trench:	Grave fills /	
Site sub-div: NC	Grave cut: /	Finds
Plan no: 3	Skeleton: 646	None
Section no:	Matrix location: 645 646	Breastplate
Co-ordinates:	Preservation: GOOD.	Grip
Levels	Slide No.	Hinge
Slide No.	Neg No:	Bracket
Description		Fixing nails
Discussion	E-W Adolescent burial - bone problems poss. niches?	Shroud pins
Shape, dimensions and distinguishing characteristics		Fabric
LID		Other finds
HEAD		
BASE		
Recorder: D. Ham	Date: 13-10-00.	Initials:

# Coffin Recording Sheet

Site Code

Context

**Outer Coffin**

Sample Ret.

*Orl00*

*646*

Recording Date ..... *13/2/01* .....

Associated Numbers .....

Condition .....

Dep. Plate

Legible

Inscription

Fabric lead       ormolou       brass       tin plated pewter       gilt tin   
 iron       silvered tin       enamelled       other .....      Sample Ret.

**Shape of dep. plate**

square       rectangle       shield       tapered       lozenge   
 cartouche       oval       other .....

**Upholstery**

colour .....      shoddy       velvet       other .....      Sample Ret.

**Construction**

butt joint       mitred       pitched       other .....

Grip plate  Fabric = ormolou       brass       tin plated pewter       gilt tin   
 iron       *new type, see sheet.* silvered tin       enamelled       other .....      Sample Ret.

Grip  Fabric = ormolou       brass       iron  *x2*      Sample Ret.

Design      swag of rose       horseshoe       cherub's head       plain  *①'S*  
 other .....

Grip bolts       Corner bolts       Type =      gilt brass       brass       iron

other .....      Sample Ret.

Lid motifs       other .....      Sample Ret.

Escutcheons       other .....      Sample Ret.

Upholstery *studs*       brass       gilt brass       silvered brass       iron       enamelled   
 other ..... *2 x pieces / 1 x 00 / 1 x 00* .....      Sample Ret.

Fixings       panel nails       screws       hinges       lace       Sample Ret.

Timber type .....      Sample Ret.

**Interpretation / Comments**

.....  
 .....

SITE	COFFIN RECORD SHEET	CONTEXT NO.
OUR 00		647
Trench:	Additional sheets:	Treatment: <i>Bones collected</i>
Site sub-div: <i>NC</i>	Grave fills	
Plan no: <i>3</i>	Grave cut: <i>/</i>	Finds None
Section no:	Skeleton: <i>647</i>	Breastplate Grip
Co-ordinates:	Matrix location: <i>647</i>	Hinge Bracket
Levels	Preservation: <i>Good.</i>	Fixing nails Shroud pins
Slide No.	Neg No:	Fabric Other finds

Description *E-W Adult burial.*

Discussion

Shape, dimensions and distinguishing characteristics

LID

HEAD

BASE

Recorder: <i>D. Azim</i>	Date: <i>13.10.00.</i>	Initials:
--------------------------	------------------------	-----------



SITE <b>OLV 00</b>	COFFIN RECORD SHEET	CONTEXT NO. <b>648</b>
Trench:	Additional sheets:	Treatment: <b>bones Concrete</b>
Site sub-div: <b>NE</b>	Grave fills	
Plan no: <b>3</b>	Grave cut:	Finds None
Section no:	Skeleton: <b>648</b>	Breastplate Grip
Co-ordinates:	Matrix location: <b>648</b>	Hinge Bracket
Levels	Preservation: <b>649</b> <b>AV.</b>	Fixing nails Shroud pins
Slide No.	Neg No:	Fabric Other finds

Description **E-W ADULT BURIAL**

Discussion

Shape, dimensions and distinguishing characteristics

LID

HEAD

BASE

Recorder: <b>ABM</b>	Date: <b>13/10/00</b>	Initials:
----------------------	-----------------------	-----------

**Outer Coffin**

Sample Ret.

Site Code

Context

OK200

648

Recording Date ..... 21/2/01 .....

Associated Numbers .....

Condition .....

Dep. Plate

Legible

Inscription

Fabric lead  ormolou  brass  tin plated pewter  gilt tin   
 iron  silvered tin  enamelled  other ..... Sample Ret.

**Shape of dep. plate**

square  rectangle  shield  tapered  lozenge   
 cartouche  oval  other .....

**Upholstery**

colour ..... shoddy  velvet  other ..... Sample Ret.

**Construction**

butt joint  mitred  pitched  other .....

Grip plate  Fabric = ormolou  brass  tin plated pewter  gilt tin   
 iron  silvered tin  enamelled  other ..... Sample Ret.

Grip  Fabric = ormolou  brass  iron  *X1* Sample Ret.

Design swag of rose  horseshoe  cherub's head  *too conc. to id.* plain   
 other .....

Grip bolts  Corner bolts  Type = gilt brass  brass  iron   
 other ..... Sample Ret.

Lid motifs  other ..... Sample Ret.

Escutcheons  other ..... Sample Ret.

Upholstery <sup>studs</sup> ~~nails~~  brass  gilt brass  silvered brass  iron  enamelled   
 other *1 piece* ~~on aaaa~~ ~~no studs~~ = 18 studs. Sample Ret.

Fixings  panel nails  screws  hinges  lace  Sample Ret.

Timber type ..... Sample Ret.

**Interpretation / Comments**

.....  
 .....



SITE	COFFIN RECORD SHEET	CONTEXT NO.
OLR.00		650
Trench:	Additional sheets:	Treatment:
Site sub-div: NC	Grave fills /	Bones collected.
Plan no: 3	Grave cut: /	Finds
Section no:	Skeleton: 650	None
Co-ordinates:	Matrix location: 649 650	Breastplate
Levels	Preservation: (650)	Grip
Slide No.	Neg No:	Hinge
Description E-W Adult burial.		Bracket
Discussion		Fixing nails
Shape, dimensions and distinguishing characteristics		Shroud pins
LID		Fabric
HEAD		Other finds
BASE		
Recorder: D. H. M.	Date: 13.10.00.	Initials:

**Outer Coffin**

Sample Ret.

Site Code

Context

06200

650

Recording Date ..... 22/2/01 .....

Associated Numbers .....

Condition .....

Dep. Plate

Legible

Inscription

Fabric lead  ormolou  brass  tin plated pewter  gilt tin   
 iron  silvered tin  enamelled  other ..... Sample Ret.

**Shape of dep. plate**

square  rectangle  shield  tapered  lozenge   
 cartouche  oval  other .....

**Upholstery**

colour ..... shoddy  velvet  other *beize* ..... Sample Ret.

**Construction** butt joint  mitred  pitched  other .....

**Grip plate**  Fabric = ormolou  brass  tin plated pewter  gilt tin   
 iron  *(27)* silvered tin  enamelled  other ..... Sample Ret.

**Grip**  Fabric = ormolou  brass  iron  *X2* Sample Ret.

**Design** swag of rose  horseshoe  cherub's head  *(20)'s* plain   
 other .....

**Grip bolts**  **Corner bolts**  **Type =** gilt brass  brass  iron   
 other ..... Sample Ret.

**Lid motifs**  other ..... Sample Ret.

**Escutcheons**  other ..... Sample Ret.

**Upholstery** *stud*  brass  gilt brass  silvered brass  iron  enamelled   
 other *1 x piece* ..... *= 68 studs* ..... Sample Ret.

**Fixings**  panel nails  screws  hinges  lace  Sample Ret.

**Timber type** ..... Sample Ret.

**Interpretation / Comments**

.....  
 .....

SITE <u>OLR00</u>		COFFIN RECORD SHEET	CONTEXT NO. <u>651</u>
Trench:	Additional sheets: <u>YES x1</u>	Treatment: <u>B. COLLECTED</u>	
Site sub-div: <u>NC</u>	Grave fills		
Plan no: <u>3</u>	Grave cut:	Finds None	
Section no:	Skeleton: <u>651</u>	Breastplate Grip <input checked="" type="checkbox"/>	
Co-ordinates:	Matrix location: <u>651</u> <u>652</u>	Hinge Bracket	
Levels	Preservation:	Fixing nails Shroud pins	
Slide No.	Neg No:	Fabric Other finds	
Description <u>E-A W ADULT BURIAL - HEAVILY JUMBLED WITH</u> <u>(652) DUE TO SECTION COLLAPSE - SOME BONE LOST DUE TO THIS</u>			
Discussion			
Shape, dimensions and distinguishing characteristics			
LID			
HEAD			
BASE			
Recorder: <u>[Signature]</u>	Date: <u>13/10/00</u>	Initials:	

# Coffin Recording Sheet

Site Code

Context

OH200

651

**Outer Coffin**

Sample Ret.

Recording Date ..... 14/2/01 .....

Associated Numbers .....

Condition ..... 1 .....

Dep. Plate

Legible  NO - PARTIAL.

Inscription

*TOP RHS CORNER ONLY.  
single rose & part of shield only visible.*

Fabric lead  ormolou  brass  tin plated pewter  gilt tin   
iron  silvered tin  enamelled  other ..... Sample Ret.

**Shape of dep. plate ?**

square  rectangle  shield  tapered  lozenge   
cartouche  oval  other .....

**Upholstery**

colour ..... shoddy  velvet  other ..... Sample Ret.

**Construction**

butt joint  mitred  pitched  other .....

**Grip plate**

Fabric = ormolou  brass  tin plated pewter  gilt tin   
iron  silvered tin  enamelled  other ..... Sample Ret.   
*knobs on rev of grip-wood.*

**Grip**

Fabric = ormolou  brass  iron  x 2 Sample Ret.

**Design**

swag of rose  horseshoe  cherub's head  (4)'s plain

other .....

**Grip bolts**

**Corner bolts**  Type = gilt brass  brass  iron

other ..... Sample Ret.

**Lid motifs**

other ..... Sample Ret.

**Escutcheons**

other ..... Sample Ret.

**Upholstery nails**

brass  gilt brass  silvered brass  iron  enamelled

other ..... Sample Ret.

**Fixings**

panel nails  screws  hinges  lace  Sample Ret.

**Timber type** .....

Sample Ret.

**Interpretation / Comments**

.....  
.....

SITE	OLR00	COFFIN RECORD SHEET	CONTEXT NO.	652	
Trench:		Additional sheets:	YES x1	Treatment:	B. CORRECTED
Site sub-div:	NC	Grave fills			
Plan no:	3	Grave cut:		Finds	None
Section no:		Skeleton:	652	Breastplate	Grip <input checked="" type="checkbox"/>
Co-ordinates:		Matrix location:	651 652	Hinge	Bracket
Levels		Preservation:		Fixing nails	Shroud pins
Slide No.		Neg. No:		Fabric	Other finds

Description

E - A W ADULT BURIAL. FULLY JUMBLED WITH 651  
DUE TO SECTION COLLAPSE - SOME BONE LOST TO T19.

Discussion

Shape, dimensions and distinguishing characteristics

LID

HEAD

BASE

Recorder:	EM/AN	Date:	15/10/00	Initials:	
-----------	-------	-------	----------	-----------	--



Site Code

Context

**Outer Coffin**

Sample Ret.

0200

652

Recording Date ..... 13/2/01 .....

Associated Numbers .....

Condition .....

Dep. Plate

Legible

Inscription

Fabric lead       ormolou       brass       tin plated pewter       gilt tin   
 iron       silvered tin       enamelled       other .....      Sample Ret.

**Shape of dep. plate**

square       rectangle       shield       tapered       lozenge   
 cartouche       oval       other .....

**Upholstery**

colour .....      shoddy       velvet       other .....      Sample Ret.

**Construction**      butt joint       mitred       pitched       other .....

**Grip plate**  Fabric = ormolou       brass       tin plated pewter       gilt tin   
 iron  *frags on rev. of grip - wood*      silvered tin       enamelled       other .....      Sample Ret.

**Grip**  Fabric = ormolou       brass       iron  <sup>x3</sup>      Sample Ret.

**Design**      swag of rose       horseshoe       cherub's head       plain   
 other ..... (4)

**Grip bolts**       **Corner bolts**       **Type =**      gilt brass       brass       iron

other .....      Sample Ret.

**Lid motifs**       other .....      Sample Ret.

**Escutcheons**       other .....      Sample Ret.

**Upholstery nails**       brass       gilt brass       silvered brass       iron       enamelled

other .....      Sample Ret.

**Fixings**       panel nails       screws       hinges       lace       Sample Ret.

**Timber type** .....      Sample Ret.

**Interpretation / Comments**

.....  
 .....

SITE OLR 00	COFFIN RECORD SHEET	CONTEXT NO. 653
Trench:	Additional sheets:	Treatment: BONE CONTAINED
Site sub-div: NC	Grave fills	
Plan no: 3	Grave cut:	Finds None
Section no:	Skeleton: 653	Breastplate Grip <input checked="" type="checkbox"/>
Co-ordinates:	Matrix location 653 654	Hinge Bracket
Levels	Preservation:	Fixing nails Shroud pins
Slide No.	Neg No:	Fabric Other finds

**Description** E & W ADULT BURIAL. TRUNCATED BY CHANNEL PIT? THUS RIGHT-SIDE MISSING.

**Discussion**

**Shape, dimensions and distinguishing characteristics**

LID

HEAD

BASE

Recorder: <i>[Signature]</i>	Date: 13/10/00	Initials:
------------------------------	----------------	-----------

Site Code

Context

**Outer Coffin**

Sample Ret.

0200

653

Recording Date ..... 16/2/01 .....

Associated Numbers .....

Condition .....

Dep. Plate

Legible

Inscription

Fabric lead  ormolou  brass  tin plated pewter  gilt tin   
 iron  silvered tin  enamelled  other ..... Sample Ret.

**Shape of dep. plate**

square  rectangle  shield  tapered  lozenge   
 cartouche  oval  other .....

**Upholstery**

colour ..... shoddy  velvet  other ..... Sample Ret.

**Construction**

butt joint  mitred  pitched  other .....

**Grip plate**

Fabric = ormolou  brass  tin plated pewter  gilt tin   
 iron  silvered tin  enamelled  other ..... Sample Ret.   
*modiglianitic pieces - unid. block*

**Grip**

Fabric = ormolou  brass  iron  Sample Ret.   
*too conc. to id.*

**Design**

swag of rose  horseshoe  cherub's head  plain   
 other .....

**Grip bolts**

**Corner bolts**  Type = gilt brass  brass  iron

other ..... Sample Ret.

**Lid motifs**

other ..... Sample Ret.

**Escutcheons**

other ..... Sample Ret.

**Upholstery nails**

brass  gilt brass  silvered brass  iron  enamelled

other ..... Sample Ret.

**Fixings**

panel nails  screws  hinges  lace  Sample Ret.

**Timber type**

Sample Ret.

**Interpretation / Comments**

.....  
 .....

SITE	COFFIN RECORD SHEET	CONTEXT NO.
AR00	Additional sheets: YES x1	654 Treatment: B. CONCRETE
Trench:	Grave fills	
Site sub-div: NC	Grave cut:	Finds
Plan no: 3	Skeleton: 654	None
Section no:	Matrix location: (653) (654)	Breastplate
Co-ordinates:	Preservation:	Grip ✓
Levels	Neg No:	Hinge
Slide No.	Discussion	Bracket
<p>Description: E-AW ADULT BURIAL. TRUNCATED BY CHANNEL PIT? NO VISIBLE SIDE OF SKELETON. V. TALL SKELETAL REMS.</p>		
<p>Shape, dimensions and distinguishing characteristics</p> <p>LID</p> <p>HEAD</p> <p>BASE</p>		
Recorder: [Signature]	Date: 13/10/00	Initials:

# Coffin Recording Sheet

Site Code

Context

**Outer Coffin**

Sample Ret.

02200

654

Recording Date ..... 13/2/01 .....

Associated Numbers .....

Condition .....

Dep. Plate

Legible

Inscription

Fabric lead  ormolou  brass  tin plated pewter  gilt tin   
 iron  silvered tin  enamelled  other ..... Sample Ret.

**Shape of dep. plate**

square  rectangle  shield  tapered  lozenge   
 cartouche  oval  other .....

**Upholstery**

colour ..... shoddy  velvet  other ..... Sample Ret.

**Construction**

butt joint  mitred  pitched  other .....

**Grip plate**

Fabric = ormolou  brass  tin plated pewter  gilt tin   
*Fabric on lev of grips - unid*

iron  silvered tin  enamelled  other ..... Sample Ret.

**Grip**

Fabric = ormolou  brass  iron  Sample Ret.

**Design**

swag of rose  horseshoe  cherub's head  (4) 5 plain

other .....

**Grip bolts**

**Corner bolts**  Type = gilt brass  brass  iron

other ..... Sample Ret.

**Lid motifs**

other ..... Sample Ret.

**Escutcheons**

other ..... Sample Ret.

**Upholstery nails**

brass  gilt brass  silvered brass  iron  enamelled

other ..... Sample Ret.

**Fixings**

panel nails  screws  hinges  lace  Sample Ret.

**Timber type**

..... Sample Ret.

**Interpretation / Comments**

.....  
 .....

db

SITE <b>OUR00</b>	COFFIN RECORD SHEET	CONTEXT NO. <b>655</b>
Trench:	Additional sheets: <b>YES X2.</b>	Treatment: <b>Bone calc./DNA</b>
Site sub-div: <b>NC</b>	Grave fills	
Plan no: <b>3</b>	Grave cut:	Finds None
Section no:	Skeleton: <b>655</b>	Breastplate <input checked="" type="checkbox"/> Grip
Co-ordinates:	Matrix location:	Hinge Bracket
Levels:	Preservation:	Fixing nails Shroud pins
Slide No.	Neg No:	Fabric Other finds

Description **E-W ADULT PURIAL - WOODEN LEAD LINED COFFIN WITH INTERNAL WOOD - TOP & BASE SOLIDIFIED SINT - SOLIDIFIED BREASTPLATE**

Discussion

Shape, dimensions and distinguishing characteristics

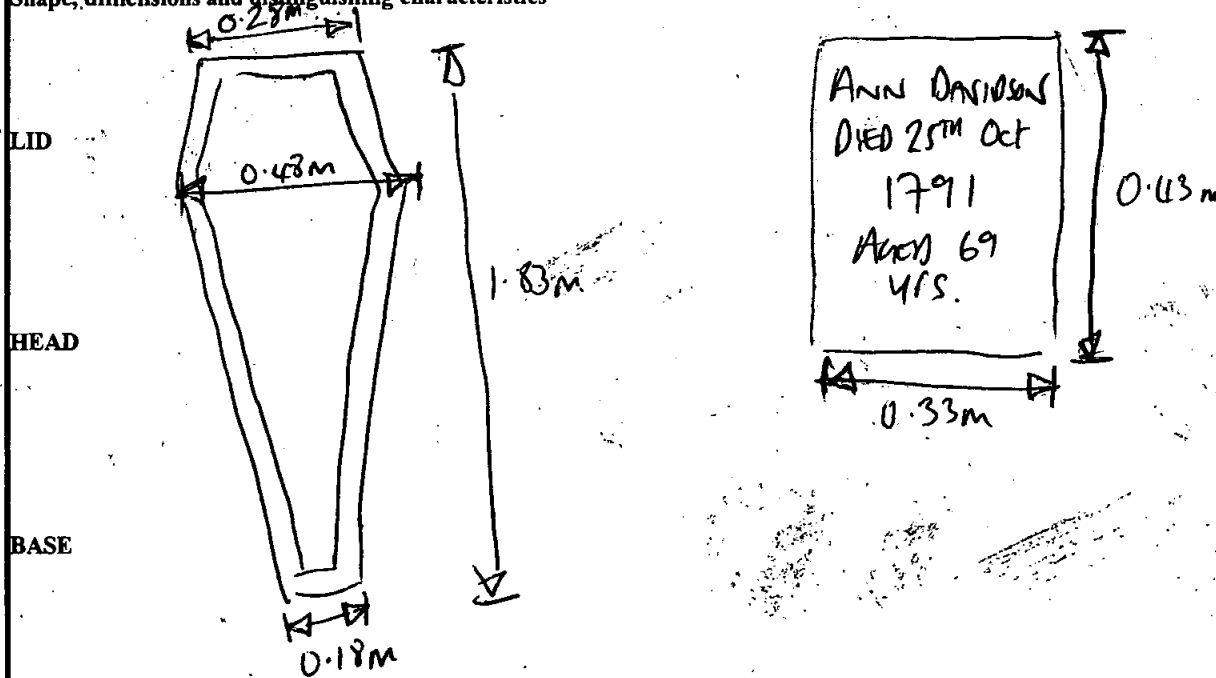

Recorder: <b>[Signature]</b>	Date: <b>13/10/00</b>	Initials:
------------------------------	-----------------------	-----------

Site Code

Context

OR 100

655

**Outer Coffin**

Sample Ret.

Recording Date ..... 2/11/00 .....

Associated Numbers .....

Condition ..... 4 .....

Dep. Plate

Legible

Inscription "Mrs Ann Davidson / Died 25<sup>th</sup> Oct<sup>r</sup> / 1791 / Aged 69 / YKO  
new type.

Fabric lead  ormolou  brass  tin plated pewter  gilt tin   
iron  silvered tin  enamelled  other ..... Sample Ret.

**Shape of dep. plate**

square  rectangle  (w/  inscription) shield  tapered  lozenge   
cartouche  oval  other .....

**Upholstery**

colour ..... shoddy  velvet  other ..... Sample Ret.

**Construction**

butt joint  mitred  pitched  other .....

Grip plate  Fabric = ormolou  brass  tin plated pewter  gilt tin   
iron  silvered tin  enamelled  other ..... Sample Ret.

Grip  Fabric = ormolou  brass  iron  x1 Sample Ret.

Design swag of rose  horseshoe  cherub's head  ① plain   
other .....

Grip bolts  Corner bolts  Type = gilt brass  brass  iron   
other ..... Sample Ret.

Lid motifs  other ..... Sample Ret.

Escutcheons  other ..... Sample Ret.

Upholstery nails  brass  gilt brass  silvered brass  iron  enamelled   
other ..... Sample Ret.

Fixings  panel nails  screws  hinges  lace  Sample Ret.

Timber type ..... Sample Ret.

**Interpretation / Comments**

.....  
.....

SITE <u>OLR 50</u>		COFFIN RECORD SHEET		CONTEXT NO. <u>656</u>	
Trench:		Additional sheets:		Treatment: <u>Bones collected.</u>	
Site sub-div: <u>NC</u>		Grave fills			
Plan no: <u>3</u>		Grave cut: <u>/</u>		Finds	
Section no:		Skeleton: <u>656</u>		None	
Co-ordinates:		Matrix location: <u>655</u> <u>656</u>		Breastplate <input checked="" type="checkbox"/> - <u>Illegible in field.</u>	
Levels		Preservation: <u>Good</u>		Grip	
Slide No.		Neg No:		Hinge	
Description				Bracket	
Discussion				Fixing nails	
Shape, dimensions and distinguishing characteristics				Shroud pins	
LID				Fabric	
HEAD				Other finds	
BASE					
Recorder: <u>D Hall</u>		Date: <u>16.10.50.</u>		Initials:	

E.W. Adult burial - Lead coffin, nameplate illegible in field.  
Dimensions - 1.8m x 0.5m.



**Outer Coffin**

Sample Ret.

Site Code

Context

Recording Date ..... 21/2/01 .....

OK200

656

Associated Numbers .....

Condition .....

Dep. Plate

Legible

Inscription Mrs/Mary Williamson/Obit 28<sup>th</sup> June/1791/Atlet 71.

*same as 657.  
w/699 border w  
plain outer gilt tin*

Fabric lead  ormolou  brass  tin plated pewter   
 iron  silvered tin  enamelled  other ..... Sample Ret.

**Shape of dep. plate**

square  rectangle  shield  tapered  lozenge   
 cartouche  oval  other .....

**Upholstery**

colour ..... shoddy  velvet  other ..... Sample Ret.

**Construction**

butt joint  mitred  pitched  other .....

Grip plate  Fabric = ormolou  brass  tin plated pewter  gilt tin   
 iron  silvered tin  enamelled  other ..... Sample Ret.

Grip  Fabric = ormolou  brass  iron  <sup>x 1</sup> Sample Ret.

Design swag of rose  horseshoe  cherub's head  plain   
 other .....

Grip bolts  Corner bolts  Type = gilt brass  brass  iron

other ..... Sample Ret.

Lid motifs  other ..... Sample Ret.

Escutcheons  other ..... Sample Ret.

Upholstery nails  brass  gilt brass  silvered brass  iron  enamelled   
 other ..... Sample Ret.

Fixings  panel nails  screws  hinges  lace  Sample Ret.

Timber type ..... Sample Ret.

**Interpretation / Comments**

.....  
 .....

SITE AR00	COFFIN RECORD SHEET	CONTEXT NO. 657
Trench:	Additional sheets:	Treatment: <i>bones/DNA</i>
Site sub-div: <i>NC</i>	Grave fills	
Plan no: <i>3</i>	Grave cut:	Finds None
Section no:	Skeleton:	Breastplate <input checked="" type="checkbox"/> Grip
Co-ordinates:	Matrix location: <i>(656)</i> <i>(657)</i>	Hinge Bracket
Levels	Preservation: <i>Good</i>	Fixing nails Shroud pins
Slide No.	Neg No:	Fabric Other finds

Description *E-W ADZE SHIRT - LEAD LINED COFFIN - SOLIDIFIED  
SWT TOP & BOTTOM*

Discussion

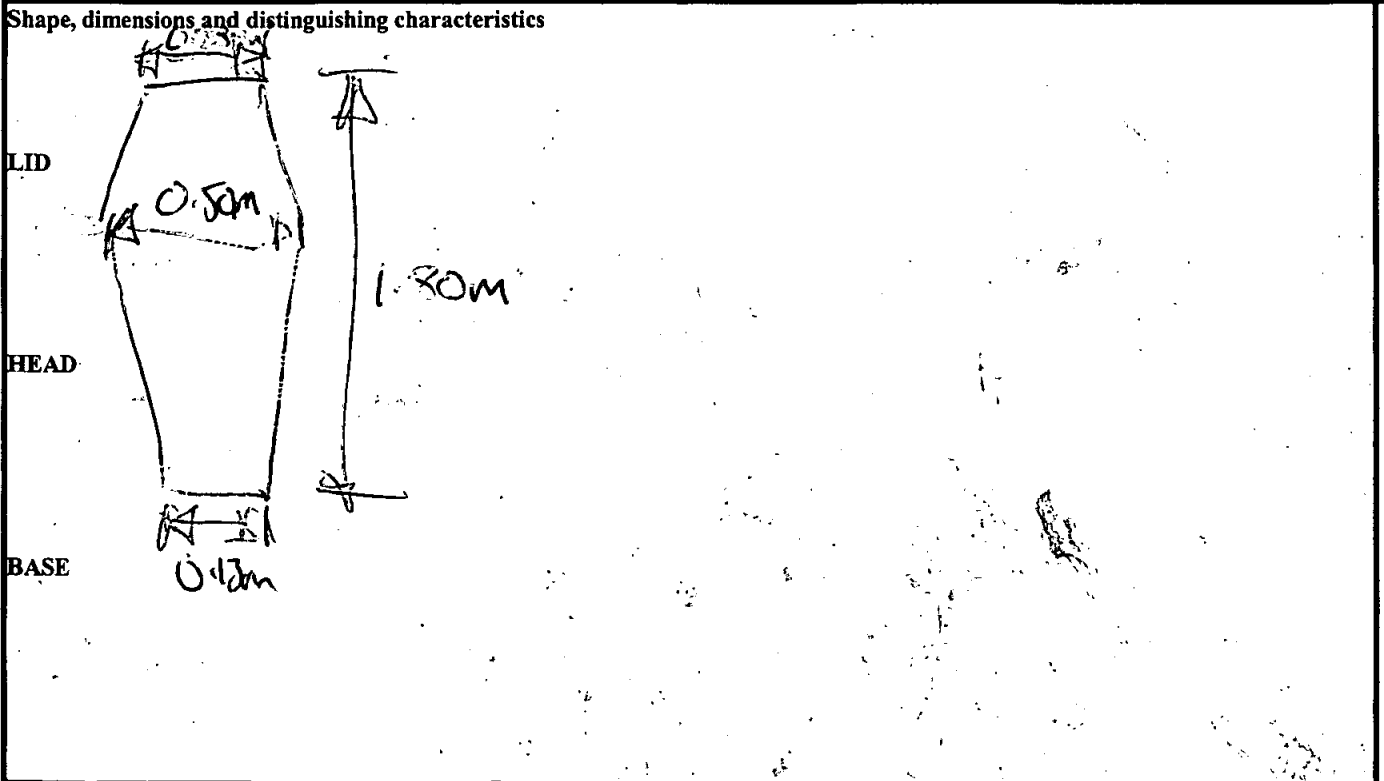

Recorder: <i>ABM</i>	Date:	Initials:
----------------------	-------	-----------

# Coffin Recording Sheet

Site Code

Context

**Outer Coffin**

Sample Ret.

OLR00

657

Recording Date ..... 16/2/01 .....

Associated Numbers .....

Condition .....

Dep. Plate

Legible

Inscription

Fabric lead  ormolou  brass  tin plated pewter  gilt tin   
 iron  silvered tin  enamelled  other ..... Sample Ret.

**Shape of dep. plate**

square  rectangle  shield  tapered  lozenge   
 cartouche  oval  other .....

**Upholstery**

colour ..... shoddy  velvet  other *bolts* ..... Sample Ret.

**Construction**

butt joint  mitred  pitched  other .....

**Grip plate**  Fabric = ormolou  brass  tin plated pewter  gilt tin   
 iron  silvered tin  enamelled  other ..... Sample Ret.

**Grip**  Fabric = ormolou  brass  iron  Sample Ret.

**Design** swag of rose  horseshoe  cherub's head  plain   
 other .....

**Grip bolts**  **Corner bolts**  **Type =** gilt brass  brass  iron   
 other .....

**Lid motifs**  other .....

**Escutcheons**  other .....

**Upholstery** <sup>studs</sup> nails  brass  gilt brass  silvered brass  iron  enamelled   
 other *4 x pieces 1 x [drawing] / 1 x [drawing] / 1 x [drawing] / 1 x [drawing] = 51 studs.* Sample Ret.

**Fixings**  panel nails  screws  hinges  lace  Sample Ret.

**Timber type** ..... Sample Ret.

**Interpretation / Comments**

.....  
 .....

Site Code

Context

**Outer Coffin**

Sample Ret.

OLR00

657

Recording Date ..... 19/2/01 .....

Associated Numbers .....

Condition ..... 3 .....

Dep. Plate

Legible

Inscription *MR Cuthbert/Wilkinson/Obit 22<sup>nd</sup> Oct<sup>r</sup>/1787/Aet 68*

*'new' type - hybrid w/ (3) see sheet.*

Fabric lead  ormolou  brass  tin plated pewter   
 iron  silvered tin  enamelled  other ..... Sample Ret.   
*black polished.*

**Shape of dep. plate**

square  rectangle  shield  tapered  lozenge   
 cartouche  oval  other .....

**Upholstery**

colour ..... shoddy  velvet  other ..... Sample Ret.

**Construction**

butt joint  mitred  pitched  other .....

**Grip plate**  Fabric = ormolou  brass  tin plated pewter  gilt tin   
 iron  silvered tin  enamelled  other ..... Sample Ret.

**Grip**  Fabric = ormolou  brass  iron  Sample Ret.

**Design** swag of rose  horseshoe  cherub's head  plain   
 other .....

**Grip bolts**  **Corner bolts**  **Type =** gilt brass  brass  iron   
 other ..... Sample Ret.

**Lid motifs**  other ..... Sample Ret.

**Escutcheons**  other ..... Sample Ret.

**Upholstery nails**  brass  gilt brass  silvered brass  iron  enamelled   
 other ..... Sample Ret.

**Fixings**  panel nails  screws  hinges  lace  Sample Ret.

**Timber type** ..... Sample Ret.

**Interpretation / Comments**

.....  
 .....

SITE <i>OLR 00</i>	COFFIN RECORD SHEET	CONTEXT NO. <i>658</i>
Trench:	Additional sheets:	Treatment: <i>Bones collected</i>
Site sub-div: <i>Nc</i>	Grave fills <i>/</i>	
Plan no: <i>3</i>	Grave cut: <i>/</i>	Finds None
Section no:	Skeleton: <i>658</i>	Breastplate Grip
Co-ordinates:	Matrix location: <i>657</i> <i>658</i> <i>659</i>	Hinge Bracket
Levels	Preservation: <i>Good/FAIR.</i>	Fixing nails Shroud pins
Slide No.	Neg No:	Fabric Other finds
Description <i>E-W Baby/child burial of/ies 659, of/ies 657.</i>		
Discussion		
Shape, dimensions and distinguishing characteristics		
LID		
HEAD		
BASE		
Recorder: <i>D. Hall</i>	Date: <i>16.10.00.</i>	Initials:

SITE <i>OLR 00</i>		COFFIN RECORD SHEET	CONTEXT NO. <i>659</i>
Trench:	Additional sheets:	Treatment: <i>Bones collected.</i>	
Site sub-div: <i>NC</i>	Grave fills: <i>/</i>		
Plan no: <i>3</i>	Grave cut: <i>/</i>	Finds None	
Section no:	Skeleton: <i>659</i>	Breastplate Grip	
Co-ordinates:	Matrix location: <i>658</i> <i>659</i>	Hinge Bracket	
Levels:	Preservation: <i>Good.</i>	Fixing nails Shroud pins	
Slide No.:	Neg No:	Fabric Other finds	
<p>Description <i>E-W Adult burial of/in by 658.</i></p> <p><i>Cranial fragments + cervical vertebrae not belonging to sk 659, fixed in. New number 1309 given for additional repair</i></p>			
<p>Discussion</p>			
<p>Shape, dimensions and distinguishing characteristics</p> <p>LID</p> <p>HEAD</p> <p>BASE</p>			
Recorder: <i>D. Hall</i>	Date: <i>16.10.00.</i>	Initials:	

db

SITE OLR 00	COFFIN RECORD SHEET	CONTEXT NO. 660
Trench:	Additional sheets: NES X 1.	Treatment: DATE COVERED
Site sub-div: NC	Grave fills	
Plan no: 3	Grave cut:	Finds None
Section no:	Skeleton:	Breastplate Grip ✓
Co-ordinates:	Matrix location: <u>661</u> <u>660</u>	Hinge Bracket
Levels	Preservation:	Fixing nails Shroud pins
Slide No.	Neg No:	Fabric Other finds

Description  
EAW ADULT BURIAL

Discussion

Shape, dimensions and distinguishing characteristics

LID

HEAD

BASE

Recorder: <i>[Signature]</i>	Date: 16/10/08	Initials:
---------------------------------	-------------------	-----------

# Coffin Recording Sheet

Site Code

Context

**Outer Coffin**

Sample Ret.

Ohloo

660

Recording Date ..... 14/12/00 .....

Associated Numbers .....

Condition .....

Dep. Plate

Legible

Inscription

Fabric lead       ormolou       brass       tin plated pewter       gilt tin   
 iron       silvered tin       enamelled       other .....      Sample Ret.

**Shape of dep. plate**

square       rectangle       shield       tapered       lozenge   
 cartouche       oval       other .....

**Upholstery**

colour .....      shoddy       velvet       other .....      Sample Ret.

**Construction**

butt joint       mitred       pitched       other .....

**Grip plate**

Fabric = ormolou       brass       tin plated pewter       gilt tin   
 iron  *x1 ③ spruce*      silvered tin       enamelled       other .....      Sample Ret.

**Grip**

Fabric = ormolou       brass       iron  *x1*      Sample Ret.

**Design**

swag of rose       horseshoe       cherub's head       plain

other .....

**Grip bolts**

**Corner bolts**       Type = gilt brass       brass       iron

other .....      Sample Ret.

**Lid motifs**

other .....

Sample Ret.

**Escutcheons**

other .....

Sample Ret.

**Upholstery nails**

brass       gilt brass       silvered brass       iron       enamelled

other .....      Sample Ret.

**Fixings**

panel nails       screws       hinges       lace       Sample Ret.

**Timber type**

Sample Ret.

**Interpretation / Comments**

.....  
 .....



SITE <u>01200</u>	COFFIN RECORD SHEET	CONTEXT NO. <u>661</u>
Trench:	Additional sheets:	Treatment: <u>DO NOT COVERED</u>
Site sub-div: <u>NC</u>	Grave fills	
Plan no: <u>3</u>	Grave cut:	Finds None
Section no:	Skeleton:	Breastplate Grip
Co-ordinates:	Matrix location: <u>661</u>	Hinge Bracket
Levels	Preservation: <u>660</u>	Fixing nails Shroud pins
Slide No.	Neg No:	Fabric Other finds
Description <u>E &amp; W INFANT BURIAL</u>		
Discussion		
Shape, dimensions and distinguishing characteristics		
LID		
HEAD		
BASE		
Recorder: <u>RM</u>	Date: <u>16/10/08</u>	Initials:

SITE <b>OLL00</b>	COFFIN RECORD SHEET	CONTEXT NO. <b>662</b>
Trench:	Additional sheets: <b>YES x1</b>	Treatment: <b>SOME COVERED</b>
Site sub-div: <b>NC</b>	Grave fills	
Plan no: <b>S</b>	Grave cut:	Finds None
Section no:	Skeleton:	Breastplate Grip
Co-ordinates:	Matrix location: <b>(662)</b>	Hinge Bracket
Levels	Preservation:	Fixing nails Shroud pins
Slide No.	Neg No:	Fabric Other finds
Description <b>E-W ADULT BURIAL</b>		
Discussion		
Shape, dimensions and distinguishing characteristics		
LID		
HEAD		
BASE		
Recorder: <b>AM</b>	Date: <b>16/10/00</b>	Initials:

Site Code

Context

**Outer Coffin**

Sample Ret.

02200

662

Recording Date 14/2/01

Associated Numbers .....

Condition .....

Dep. Plate

Legible

Inscription

Fabric lead  ormolou  brass  tin plated pewter  gilt tin   
 iron  silvered tin  enamelled  other ..... Sample Ret.

**Shape of dep. plate**

square  rectangle  shield  tapered  lozenge   
 cartouche  oval  other .....

**Upholstery**

colour ..... shoddy  velvet  other *woize on kev of studs* Sample Ret.

**Construction** butt joint  mitred  pitched  other .....

**Grip plate**  Fabric = ormolou  brass  tin plated pewter  gilt tin   
 iron  *Resins on kev of grip - unid.* silvered tin  enamelled  other ..... Sample Ret.

**Grip**  Fabric = ormolou  brass  iron  *x 3* Sample Ret.

**Design** swag of rose  horseshoe  cherub's head  *too conc. to id. plain*

**Grip bolts**  **Corner bolts**  **Type =** gilt brass  brass  iron

other ..... Sample Ret.

**Lid motifs**  other ..... Sample Ret.

**Escutcheons**  other ..... Sample Ret.

**Upholstery** *studs*  brass  gilt brass  silvered brass  iron  enamelled   
 other *2 pieces - 1 x [drawing] / 1 x [drawing] = 19 studs.* Sample Ret.

**Fixings**  panel nails  screws  hinges  lace  Sample Ret.

**Timber type** ..... Sample Ret.

**Interpretation / Comments**

.....  
 .....

SITE	COFFIN RECORD SHEET	CONTEXT NO.
OLR 00		663
Trench:	Additional sheets:	Treatment: Bones collected.
Site sub-div: NC	Grave fills /	
Plan no: 3	Grave cut: /	Finds None
Section no:	Skeleton: 663	Breastplate Grip
Co-ordinates:	Matrix location: 662 663 664	Hinge Bracket
Levels	Preservation: good.	Fixing nails Shroud pins
Slide No.	Neg No:	Fabric Other finds
Description E-W Adult burial - <del>at</del> ulies 662.		
Discussion		
Shape, dimensions and distinguishing characteristics		
LID           HEAD           BASE		
Recorder: D. Hall	Date: 16.10.00.	Initials:

SITE <i>02100</i>	COFFIN RECORD SHEET	CONTEXT NO. <i>664</i>
Trench:	Additional sheets:	Treatment: <i>BONE COLLECTED</i>
Site sub-div: <i>NC</i>	Grave fills	
Plan no: <i>3</i>	Grave cut:	Finds None
Section no:	Skeleton: <i>(663)</i> <i>(664)</i>	Breastplate Grip
Co-ordinates:	Matrix location:	Hinge Bracket
Levels	Preservation: <i>good</i>	Fixing nails Shroud pins
Slide No.	Neg No:	Fabric Other finds
<p>Description <i>6-0 Adult, mixed</i></p> <p>Discussion</p>		
<p>Shape, dimensions and distinguishing characteristics</p> <p>LID</p> <p>HEAD</p> <p>BASE</p>		
Recorder: <i>[Signature]</i>	Date: <i>16/10/00</i>	Initials:

**Outer Coffin**

Sample Ret.

Site Code

Context

Recording Date ..... *16/2/01* .....

*Oh200*

*664*

Associated Numbers .....

Condition .....

Dep. Plate

Legible

Inscription

Fabric lead  ormolou  brass  tin plated pewter  gilt tin   
 iron  silvered tin  enamelled  other ..... Sample Ret.

**Shape of dep. plate**

square  rectangle  shield  tapered  lozenge   
 cartouche  oval  other .....

**Upholstery**

colour ..... shoddy  velvet  other *bi-zac* ..... Sample Ret.

**Construction**

butt joint  mitred  pitched  other .....

**Grip plate**

Fabric = ormolou  brass  tin plated pewter  gilt tin   
 iron  *frags on rev of grip - unid* silvered tin  enamelled  other ..... Sample Ret.

**Grip**

Fabric = ormolou  brass  iron  *x1* Sample Ret.

**Design**

swag of rose  horseshoe  cherub's head  *too cone to id* plain

other .....

**Grip bolts**

**Corner bolts**  Type = gilt brass  brass  iron

other ..... Sample Ret.

**Lid motifs**

other ..... Sample Ret.

**Escutcheons**

other ..... Sample Ret.

**Upholstery**

*stud nails* brass  gilt brass  silvered brass  iron  enamelled

other *2 x pieces 1x [drawing] / 1x [drawing] = 27 studs* ..... Sample Ret.

**Fixings**

panel nails  screws  hinges  lace  Sample Ret.

**Timber type** .....

Sample Ret.

**Interpretation / Comments**

.....  
 .....

SITE 2LR00		COFFIN RECORD SHEET		CONTEXT NO. 665	
Trench:		Additional sheets: 465 x 1		Treatment:	
Site sub-div: N.C.		Grave fills		BONE COLLECTED	
Plan no: 3		Grave cut:		Finds	
Section no:		Skeleton: 665		None	
Co-ordinates:		Matrix location: 665 666		Breastplate	
Levels		Preservation: GOOD		Grip	
Slide No.		Neg No:		Hinge	
Description		6-0 Adult seen fallen out of section as in machine bucket		Bracket	
Discussion				Fixing nails	
Shape, dimensions and distinguishing characteristics				Shroud pins	
LID				Fabric	
HEAD				Other finds	
BASE					
Recorder: [Signature]		Date: 16/10/02		Initials:	

# Coffin Recording Sheet

Site Code

Context

OLR00

665

**Outer Coffin**

Sample Ret.

Recording Date ..... 13/2/01 .....

Associated Numbers .....

Condition .....

Dep. Plate

Legible

Inscription

Fabric lead       ormolou       brass       tin plated pewter       gilt tin   
 iron       silvered tin       enamelled       other .....      Sample Ret.

**Shape of dep. plate**

square       rectangle       shield       tapered       lozenge   
 cartouche       oval       other .....

**Upholstery**

colour ..... shoddy       velvet       other .....      Sample Ret.

**Construction**

butt joint       mitred       pitched       other .....

**Grip plate**

Fabric = ormolou       brass       tin plated pewter       gilt tin   
 iron       *Flags on rev of grip-unicid*      silvered tin       enamelled       other .....      Sample Ret.

**Grip**

Fabric = ormolou       brass       iron       Sample Ret.

**Design**

swag of rose       horseshoe       cherub's head       plain       7

other .....

**Grip bolts**

**Corner bolts**       Type =      gilt brass       brass       iron

other .....      Sample Ret.

**Lid motifs**

other .....      Sample Ret.

**Escutcheons**

other .....      Sample Ret.

**Upholstery nails**

brass       gilt brass       silvered brass       iron       enamelled

other .....      Sample Ret.

**Fixings**

panel nails       screws       hinges       lace       Sample Ret.

**Timber type** .....

Sample Ret.

**Interpretation / Comments**

.....  
 .....



SITE		COFFIN RECORD SHEET		CONTEXT NO.
OLROW		Additional sheets: YES x1		-666
Trench:		Grave fills		Treatment: Bones COLLECTED
Site sub-div: NC		Grave cut:		Finds
Plan no: 3		Skeleton: 666		None
Section no:		Matrix location: 665		Breastplate
Co-ordinates:		666		Grip
Levels		667		Hinge
Slide No.		Neg No:		Bracket
Description		Preservation: GOOD		Fixing nails
Discussion		666		Shroud pins
Shape, dimensions and distinguishing characteristics		667		Fabric
LID		666		Other finds
HEAD		666		
BASE		666		
Recorder: [Signature]		Date: 16/10/02		Initials:

# Coffin Recording Sheet

Site Code

Context

**Outer Coffin**

Sample Ret.

02200

666

Recording Date ..... 13/2/01 .....

Associated Numbers .....

Condition .....

Dep. Plate

Legible

Inscription

Fabric lead  ormolou  brass  tin plated pewter  gilt tin   
 iron  silvered tin  enamelled  other ..... Sample Ret.

**Shape of dep. plate**

square  rectangle  shield  tapered  lozenge   
 cartouche  oval  other .....

**Upholstery**

colour ..... shoddy  velvet  other ..... Sample Ret.

**Construction**

butt joint  mitred  pitched  other .....

Grip plate  Fabric = ormolou  brass  tin plated pewter  gilt tin   
 iron  silvered tin  enamelled  other ..... Sample Ret.   
*Flag on rev of grip-wood.*

Grip  Fabric = ormolou  brass  iron  *x 2* Sample Ret.

Design swag of rose  horseshoe  cherub's head  *①'s.* plain   
 other .....

Grip bolts  Corner bolts  Type = gilt brass  brass  iron

other ..... Sample Ret.

Lid motifs  other ..... Sample Ret.

Escutcheons  other ..... Sample Ret.

Upholstery nails  brass  gilt brass  silvered brass  iron  enamelled

other ..... Sample Ret.

Fixings  panel nails  screws  hinges  lace  Sample Ret.

Timber type ..... Sample Ret.

**Interpretation / Comments**

.....  
 .....

db

SITE OLROU	COFFIN RECORD SHEET	CONTEXT NO. 667
Trench:	Additional sheets: YES x 1.	Treatment: BONE COLLECTED
Site sub-div: NC	Grave fills	
Plan no: 3	Grave cut:	Finds None
Section no:	Skeleton: 667	Breastplate Grip
Co-ordinates:	Matrix location: 666 667	Hinge Bracket
Levels	Preservation:	Fixing nails Shroud pins
Slide No.	Neg No:	Fabric Other finds

Description  
6-W Adult

Discussion

Shape, dimensions and distinguishing characteristics

LID

HEAD

BASE

Recorder: Jh	Date: 16/10/02	Initials:
--------------	----------------	-----------

Site Code

Context

**Outer Coffin**

Sample Ret.

OR00

667

Recording Date ..... 13/12

Associated Numbers .....

Condition .....

Dep. Plate

Legible

Inscription

Fabric lead  ormolou  brass  tin plated pewter  gilt tin   
iron  silvered tin  enamelled  other ..... Sample Ret.

**Shape of dep. plate**

square  rectangle  shield  tapered  lozenge   
cartouche  oval  other .....

**Upholstery**

colour ..... shoddy  velvet  other ..... Sample Ret.

**Construction**

butt joint  mitred  pitched  other .....

Grip plate  Fabric = ormolou  brass  tin plated pewter  gilt tin   
iron  silvered tin  enamelled  other ..... Sample Ret.   
*Feags on rev of grip - black enamelled unid.*

Grip  Fabric = ormolou  brass  iron  Sample Ret.   
*x2*

Design swag of rose  horseshoe  cherub's head  plain   
other ..... *smallish ①'s*  
*← 0.11 ↑ 0.05*

Grip bolts  Corner bolts  Type = gilt brass  brass  iron   
other ..... Sample Ret.

Lid motifs  other ..... Sample Ret.

Escutcheons  other ..... Sample Ret.

Upholstery nails  brass  gilt brass  silvered brass  iron  enamelled   
other ..... Sample Ret.

Fixings  panel nails  screws  hinges  lace  Sample Ret.

Timber type ..... Sample Ret.

**Interpretation / Comments**

.....  
.....

SITE <i>OLROE</i>	COFFIN RECORD SHEET	CONTEXT NO. <i>668</i>
Trench:	Additional sheets:	Treatment: <i>BONES COLLECTED</i>
Site sub-div: <i>NC</i>	Grave fills:	
Plan no: <i>3</i>	Grave cut:	Finds None
Section no:	Skeleton: <i>668</i>	Breastplate Grip
Co-ordinates:	Matrix location: <i>668</i> <i>669</i>	Hinge Bracket
Levels:	Preservation: <i>GOOD</i>	Fixing nails Shroud pins
Slide No.:	Neg No.:	Fabric Other finds

Description  
*6-w Skull*

Discussion

Shape, dimensions and distinguishing characteristics

LID

HEAD

BASE

Recorder: <i>Jh</i>	Date: <i>16/10/02</i>	Initials:
------------------------	--------------------------	-----------

SITE GLR00	COFFIN RECORD SHEET	CONTEXT NO. 669
Trench:	Additional sheets:	Treatment:
Site sub-div: NC	Grave fills	Screw caps
Plan no: 3	Grave cut:	Finds None
Section no:	Skeleton: 669	Breastplate Grip
Co-ordinates:	Matrix location: 668 669	Hinge Bracket
Levels	Preservation: Good	Fixing nails Shroud pins
Slide No.	Neg No:	Fabric Other finds
Description E-W Skull		
Discussion		
Shape, dimensions and distinguishing characteristics  LID  HEAD  BASE		
Recorder: Jhr	Date: 16/10/00	Initials:

SITE 0400	CONTEXT RECORD		Context No. 670
	Additional Sheets:		Type STR.
Trench	Context Type: Deposit / <del>Part</del> / Structure		Check Lists:
Site sub-div NC	Overlain by: 664 177		DEPOSIT: 1.compaction 2.colour 3.composition 4.inclusions 5.thickness 6.extent 7.comments 8.method & conditions
Structure No.	Abutted by:		
Plan No. 3	Cut by:		CUT: 1.shape in plan 2.base/sides/top profile 3.dimension and depth 4.sketch 5.truncation 6.fill nos 7.other comments
	Filled by:		
Section No.	Same as:		MASONRY: 1.materials 2.size of bricks etc 3.finish of stones 4.coursing/bond 5.form 6.faces 7.bond 8.dimensions as found 9.other comments
	Part of:		
Co-Ordinates	Consists of:		
	Overlies:		
Level	Butts:		
Slide No.	Cuts:		
Neg No.	Fill of:		
Matrix location	Relationships uncertain		

- Description (See check lists):
- ① BRICK (Red), Mortar.
  - ② 0.23m x 0.10m BRICK, 0.02m COURSE
  - Mortar
  - ③ — ④ STRAIGHT OVERLAP BRICK

STRATIGRAPHIC MATRIX

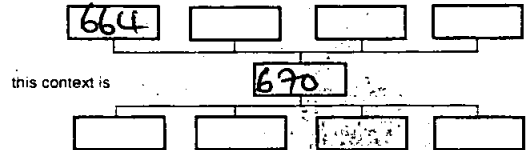

FRANNING AROUND A CIRCULAR MORTAR BANKED HOLE.  
 ⑤ CIRCULAR 'WELL-LIKE' FEATURE WITH SOME FORM OF POSSIBLE 'WELL' STRUCTURE HEADING NORTHWARDS FROM CENTRAL EDGE OF 'WELL'-LIKE BANKED WITH CONSTRUCTION WASTE (IF MORTAR). ⑧ 1.38m Ø WITH EXC. 0.25x0.4m

Interpretation/Discussion:  
 WITHIN NC WITH SMALLER 'WELL-LIKE' CONSTR. HEADING NORTH BENEATH VAULT - 'WELL' HOLE IS PRIMARILY MORTAR, SUGGESTING BACKFILLING AT TIME OF CURVE CONSTR. - SECTION PLAN (NOT TO SCALE) GRAVE 664 OVERLAP STR. 670 - WHICH IS ENTIRELY OVERL. BY CURVED SOIL 177.

Diagram description: A hand-drawn section plan of a circular feature. It shows a central circular area labeled 'WELL' surrounded by a ring of bricks. The feature is overlain by a layer labeled 'WELL STR.' and is situated within a larger area labeled '670'. Below the feature is a layer labeled '177'.

Finds (tick): None  Pot  Bone  Flint  Stone  Burnt stone  Glass  Metal  CBM  Wood  Leather

Δ Small Finds	Recorder <i>BBM</i>
◇ Samples	Date 17/10/00
△ Building Materials	Initials

SITE <u>OLROE</u>		COFFIN RECORD SHEET		CONTEXT NO. <u>671</u>	
Trench:		Additional sheets:		Treatment:	<u>BONE COLLECTED</u>
Site sub-div:	<u>NC</u>	Grave fills		Finds	
Plan no:	<u>3</u>	Grave cut:	<u>IN STRUCT 557</u>	None	
Section no:		Skeleton:	<u>671</u>	Breastplate	
Co-ordinates:		Matrix location:		Grip	
Levels		Preservation:	<u>GOOD</u>	Hinge	
Slide No.		Neg No:		Bracket	
				Fixing nails	
				Shroud pins	
				Fabric	
				Other finds	
<p>Description <u>6-w Adults machined w/ of structure <span style="border: 1px solid black; padding: 2px;">557</span> with tacked bucket. Perhaps some mixing with 672</u></p> <p>Discussion <u>(2)</u></p>					
<p>Shape, dimensions and distinguishing characteristics</p> <p>LID</p> <p>HEAD</p> <p>BASE</p>					
Recorder: <u>JH</u>		Date: <u>17/10/00</u>		Initials:	



SITE 02R00	COFFIN RECORD SHEET	CONTEXT NO. 672
Trench:	Additional sheets: YES X1	Treatment:
Site sub-div: NC	Grave fills	BONE COLLECTED
Plan no: 3	Grave cut: STRUCT 557	Finds None
Section no:	Skeleton: 672	Breastplate Grip
Co-ordinates:	Matrix location:	Hinge Bracket
Levels	Preservation: FAIR	Fixing nails Shroud pins
Slide No.	Neg No:	Fabric Other finds
<p><b>Description</b> 6-0 Adult within structure 557 perhaps moved with 671. Most probably redeposited charcoal bones</p> <p><b>Discussion</b> from a disturbed grave, but as machined out with toothed bucket could not be sure</p>		
<p><b>Shape, dimensions and distinguishing characteristics</b></p> <p>LID</p> <p>HEAD</p> <p>BASE</p>		
Recorder: <i>[Signature]</i>	Date: 17/10/00	Initials:

# Coffin Recording Sheet

Site Code

Context

**Outer Coffin**

Sample Ret.

02L00

672

Recording Date ..... 13/2/01 .....

Associated Numbers .....

Condition .....

Dep. Plate

Legible

Inscription

Fabric lead       ormolou       brass       tin plated pewter       gilt tin   
 iron       silvered tin       enamelled       other .....      Sample Ret.

**Shape of dep. plate**

square       rectangle       shield       tapered       lozenge   
 cartouche       oval       other .....

**Upholstery**

colour .....      shoddy       velvet       other .....      Sample Ret.

**Construction**

butt joint       mitred       pitched       other .....  
*? unid. be plate - no distinguishing features.*

**Grip plate**       Fabric = ormolou       brass       tin plated pewter       gilt tin   
 iron       silvered tin       enamelled       other .....      Sample Ret.

**Grip**       Fabric = ormolou       brass       iron       Sample Ret.

**Design**      swag of rose       horseshoe       cherub's head       plain   
 other .....

**Grip bolts**       **Corner bolts**       **Type =**      gilt brass       brass       iron   
 other .....      Sample Ret.

**Lid motifs**       other .....      Sample Ret.

**Escutcheons**       other .....      Sample Ret.

**Upholstery nails**       brass       gilt brass       silvered brass       iron       enamelled   
 other .....      Sample Ret.

**Fixings**       panel nails       screws       hinges       lace       Sample Ret.

**Timber type** .....      Sample Ret.

**Interpretation / Comments**

.....  
.....

SITE <i>OLR 50</i>		COFFIN RECORD SHEET	CONTEXT NO. <i>673</i>
Trench:	Additional sheets:	Treatment: <i>Bones collected.</i>	
Site sub-div: <i>N←</i>	Grave fills <i>/</i>		
Plan no: <i>3</i>	Grave cut: <i>/</i>	Finds None	
Section no:	Skeleton: <i>673</i>	Breastplate Grip	
Co-ordinates:	Matrix location: <i>673</i> <i>674</i>	Hinge Bracket	
Levels	Preservation: <i>Good.</i>	Fixing nails Shroud pins	
Slide No.	Neg No:	Fabric Other finds :	
Description <i>E-W Adult burial.</i>			
Discussion			
Shape, dimensions and distinguishing characteristics			
LID			
HEAD			
BASE			
Recorder: <i>DHM</i>	Date: <i>17.10.00</i>	Initials:	

SITE <i>OLR 00</i>		COFFIN RECORD SHEET	CONTEXT NO. <i>674</i>
Trench:	Additional sheets: <i>YES X1</i>	Treatment: <i>Bones collected</i>	
Site sub-div: <i>NC</i>	Grave fills: <i>/</i>		
Plan no: <i>3</i>	Grave cut: <i>/</i>	Finds None	
Section no:	Skeleton: <i>674</i>	Breastplate Grip	
Co-ordinates:	Matrix location: <i>673</i> <i>674</i> <i>675</i>	Hinge Bracket	
Levels	Preservation: <i>Good</i>	Fixing nails Shroud pins	
Slide No.	Neg No:	Fabric Other finds	
Description <i>E-W Adult burial.</i>			
Discussion			
Shape, dimensions and distinguishing characteristics			
LID			
HEAD			
BASE			
Recorder: <i>D H M</i>	Date: <i>17.10.00.</i>	Initials:	

# Coffin Recording Sheet

Site Code

Context

**Outer Coffin**

Sample Ret.

OL200

674

Recording Date ..... 13/2/01 .....

Associated Numbers .....

Condition .....

Dep. Plate

Legible

**Inscription**

Fabric lead  ormolou  brass  tin plated pewter  gilt tin   
 iron  silvered tin  enamelled  other ..... Sample Ret.

**Shape of dep. plate**

square  rectangle  shield  tapered  lozenge   
 cartouche  oval  other .....

**Upholstery**

colour ..... shoddy  velvet  other ..... Sample Ret.

**Construction**

butt joint  mitred  pitched  other .....

**Grip plate**

*Fabric = ormolou*  brass  tin plated pewter  gilt tin   
*Flags on lev of grip-unit.*  
 iron  silvered tin  enamelled  other ..... Sample Ret.

**Grip**

*Fabric = ormolou*  brass  iron  *4 x 2 2280* Sample Ret.

**Design**

swag of rose  horseshoe  cherub's head  plain

other .....

**Grip bolts**

**Corner bolts**  Type = gilt brass  brass  iron

other ..... Sample Ret.

**Lid motifs**

other ..... Sample Ret.

**Escutcheons**

other ..... Sample Ret.

**Upholstery nails**

brass  gilt brass  silvered brass  iron  enamelled

other ..... Sample Ret.

**Fixings**

panel nails  screws  hinges  lace  Sample Ret.

**Timber type** .....

Sample Ret.

**Interpretation / Comments**

.....  
 .....

SITE <u>OLR00</u>		COFFIN RECORD SHEET	CONTEXT NO. <u>675</u>
Trench:	Additional sheets:	Treatment: <u>BONES COLLECTED</u>	
Site sub-div: <u>NC</u>	Grave fills		
Plan no: <u>3</u>	Grave cut:	Finds None	
Section no:	Skeleton: <u>675</u>	Breastplate Grip	
Co-ordinates:	Matrix location: <u>674</u> <u>675</u> <u>1</u>	Hinge Bracket	
Levels	Preservation: <u>678</u> <u>GOOD</u>	Fixing nails Shroud pins	
Slide No.	Neg No:	Fabric Other finds	
Description <u>E-W skull</u>			
Discussion			
Shape, dimensions and distinguishing characteristics			
LID			
HEAD			
BASE			
Recorder: <u>Jha</u>	Date: <u>17/10/00</u>	Initials:	

SITE	COFFIN RECORD SHEET	CONTEXT NO.
OLR00		676
Trench:	Additional sheets: YES X1	Treatment: Bone collected.
Site sub-div: NC	Grave fills /	
Plan no: 3	Grave cut: /	Finds None
Section no:	Skeleton: 676	Breastplate Grip
Co-ordinates:	Matrix location: 676	Hinge Bracket
Levels	Preservation: FAIR.	Fixing nails Shroud pins
Slide No.	Neg No:	Fabric Other finds
<p>Description E-W Adult burial.</p> <p>Discussion</p>		
<p>Shape, dimensions and distinguishing characteristics</p> <p>LID</p> <p>HEAD</p> <p>BASE</p>		
Recorder: D. Hall	Date: 17.10.00.	Initials:

# Coffin Recording Sheet

Site Code

Context

**Outer Coffin**

Sample Ret.

OH200

676

Recording Date ..... 13/2/01 .....

Associated Numbers .....

Condition .....

Dep. Plate

Legible

Inscription

Fabric lead       ormolou       brass       tin plated pewter       gilt tin   
 iron       silvered tin       enamelled       other .....      Sample Ret.

**Shape of dep. plate**

square       rectangle       shield       tapered       lozenge   
 cartouche       oval       other .....

**Upholstery**

colour .....      shoddy       velvet       other .....      Sample Ret.

**Construction**

butt joint       mitred       pitched       other .....

Grip plate  Fabric = ormolou       brass       tin plated pewter       gilt tin   
 iron  *leags on rev. of grip-uid.*      silvered tin       enamelled       other .....      Sample Ret.

Grip  Fabric = ormolou       brass       iron  *x4*      Sample Ret.

Design      swag of rose       horseshoe       cherub's head  *①'s*      plain   
 other .....

Grip bolts       Corner bolts       Type =      gilt brass       brass       iron   
 other .....      Sample Ret.

Lid motifs       other .....

Escutcheons       other .....

Upholstery nails       brass       gilt brass       silvered brass       iron       enamelled   
 other .....      Sample Ret.

Fixings            panel nails       screws       hinges       lace       Sample Ret.

Timber type .....      Sample Ret.

**Interpretation / Comments**

.....  
 .....



SITE <i>OLR00</i>		COFFIN RECORD SHEET	CONTEXT NO. <i>677</i>
Trench:	Additional sheets:	Treatment: <i>BONE COLLECTED</i>	
Site sub-div: <i>NC</i>	Grave fills		
Plan no: <i>3</i>	Grave cut:	Finds None	
Section no:	Skeleton: <i>677</i>	Breastplate Grip	
Co-ordinates:	Matrix location: <i>678</i> <i>677</i>	Hinge <input checked="" type="checkbox"/> Bracket	
Levels	Preservation: <i>GOOD</i>	Fixing nails Shroud pins	
Slide No.	Neg No:	Fabric Other finds	
Description <i>6-w Adult underlies baby 678 over knees</i>			
Discussion			
Shape, dimensions and distinguishing characteristics			
LID			
HEAD			
BASE			
Recorder: <i>[Signature]</i>	Date: <i>17/10/00</i>	Initials:	

Site Code

Context

**Outer Coffin**

Sample Ret.

0200

677

Recording Date ..... 22/2/01 .....

Associated Numbers .....

Condition .....

Dep. Plate

Legible

Inscription

Fabric lead  ormolou  brass  tin plated pewter  gilt tin   
 iron  silvered tin  enamelled  other ..... Sample Ret.

Shape of dep. plate

square  rectangle  shield  tapered  lozenge   
 cartouche  oval  other .....

Upholstery

colour ..... shoddy  velvet  other *buize* ..... Sample Ret.

Construction butt joint  mitred  pitched  other .....

Grip plate  Fabric = ormolou  brass  tin plated pewter  gilt tin   
 iron  *knobs on rev. of grip-wood.* silvered tin  enamelled  other ..... Sample Ret.

Grip  Fabric = ormolou  brass  iron  *x2* Sample Ret.

Design swag of rose  horseshoe  cherub's head  *(36)5* plain   
 other .....

Grip bolts  Corner bolts  Type = gilt brass  brass  iron   
 other ..... Sample Ret.

Lid motifs  other ..... Sample Ret.

Escutcheons  other ..... Sample Ret.

Upholstery *stud*  brass  gilt brass  silvered brass  iron  enamelled   
 other *8 x pieces 2x ∞ / 1x ∞∞ / 1x ∞∞∞∞ / 1x ∞∞∞∞∞∞ = 22 studs* Sample Ret.

Fixings  panel nails  screws  hinges  lace  Sample Ret.

Timber type ..... Sample Ret.

Interpretation / Comments

.....  
 .....

SITE	COFFIN RECORD SHEET		CONTEXT NO.
04200	Additional sheets:	678	
Trench:	Grave fills	Bones collected	
Site sub-div: NC	Grave cut:	Finds	
Plan no: 3	Skeleton: 678	None	
Section no:	Matrix location: 675	Breastplate	
Co-ordinates:	678	Grip	
Levels	677	Hinge	
Slide No.	Preservation:	Bracket	
Neg No:	Fixing nails	Shroud pins	
Description	Fabric	Other finds	
6-0 Infarb over 677's knees			
Discussion			
Shape, dimensions and distinguishing characteristics			
LID			
HEAD			
BASE			
Recorder: [Signature]	Date: 17/10/00	Initials:	

SITE	COFFIN RECORD SHEET	CONTEXT NO.
OLR00	Additional sheets: 468 x 1	679
Trench:	Grave fills	Treatment: Bones collected
Site sub-div: NC	Grave cut:	Finds
Plan no: 3	Skeleton:	None
Section no:	679	Breastplate
Co-ordinates:	Matrix location: 679	Grip
Levels	680	Hinge
Slide No.	Preservation: Good	Bracket
Neg No:		Fixing nails
Description	E-W Skull	Shroud pins
Discussion		Fabric
Shape, dimensions and distinguishing characteristics		Other finds
LID		
HEAD		
BASE		
Recorder: [Signature]	Date: 18/10/00	Initials:

# Coffin Recording Sheet

Site Code

Context

06200

679

**Outer Coffin**

Sample Ret.

Recording Date ..... 14/2/01 .....

Associated Numbers .....

Condition .....

Dep. Plate

Legible

Inscription

Fabric lead       ormolou       brass       tin plated pewter       gilt tin   
 iron       silvered tin       enamelled       other .....      Sample Ret.

**Shape of dep. plate**

square       rectangle       shield       tapered       lozenge   
 cartouche       oval       other .....

**Upholstery**

colour .....      shoddy       velvet       other .....      Sample Ret.

**Construction**

butt joint       mitred       pitched       other .....

**Grip plate**

Fabric = ormolou       brass       tin plated pewter       gilt tin   
 iron       *frag on rev. of grip - ③*      silvered tin       enamelled       other .....      Sample Ret.

**Grip**

Fabric = ormolou       brass       iron  *x3*      Sample Ret.

**Design**

swag of rose       horseshoe       cherub's head       ④ 15      plain

other .....

**Grip bolts**

**Corner bolts**       Type =      gilt brass       brass       iron

other .....      Sample Ret.

**Lid motifs**

other .....      Sample Ret.

**Escutcheons**

other .....      Sample Ret.

**Upholstery nails**

brass       gilt brass       silvered brass       iron       enamelled

other .....      Sample Ret.

**Fixings**

panel nails       screws       hinges       lace       Sample Ret.

**Timber type** .....

Sample Ret.

**Interpretation / Comments**

.....  
 .....

SITE <i>04/00</i>		COFFIN RECORD SHEET	CONTEXT NO. <i>680</i>			
Trench:	Additional sheets:	Treatment: <i>BONE COLLECTED</i>				
Site sub-div: <i>NC</i>	Grave fills					
Plan no: <i>3</i>	Grave cut:	Finds None				
Section no:	Skeleton: <i>680</i>	Breastplate Grip				
Co-ordinates:	Matrix location: <i>679</i> <i>680</i> <i>681</i>	Hinge Bracket				
Levels	Preservation: <i>poor</i>	Fixing nails Shroud pins				
Slide No.	Neg No:	Fabric Other finds				
Description <i>6-11 Adult</i>						
Discussion <table border="0"> <tr> <td style="vertical-align: top;"> <p>Extra bones:  left 1-5 Mt  Right 1st, 3rd 5th Mt  R+L cuboid  R+L Lateral cunifom  R+L 3rd MC, R Patella</p> </td> <td style="font-size: 3em; vertical-align: middle; padding: 0 10px;">}</td> <td style="vertical-align: middle;"> <p>All same individual,  Adult  Possibly Male (large &amp; robust)  Possibly 679 or 681</p> </td> </tr> </table>				<p>Extra bones:  left 1-5 Mt  Right 1st, 3rd 5th Mt  R+L cuboid  R+L Lateral cunifom  R+L 3rd MC, R Patella</p>	}	<p>All same individual,  Adult  Possibly Male (large &amp; robust)  Possibly 679 or 681</p>
<p>Extra bones:  left 1-5 Mt  Right 1st, 3rd 5th Mt  R+L cuboid  R+L Lateral cunifom  R+L 3rd MC, R Patella</p>	}	<p>All same individual,  Adult  Possibly Male (large &amp; robust)  Possibly 679 or 681</p>				
Shape, dimensions and distinguishing characteristics						
LID						
HEAD						
BASE						
Recorder: <i>JW</i>	Date: <i>18/10/00</i>	Initials:				

SITE		COFFIN RECORD SHEET		CONTEXT NO.	
JLPOW				681	
Trench:		Additional sheets:		Treatment:	
Site sub-div: NC		Grave fills		Bones collected	
Plan no: 3		Grave cut:		Finds	
Section no:		Skeleton: 681		None	
Co-ordinates:		Matrix location: 680 681		Breastplate	
Levels		Preservation: GOOD		Grip	
Slide No.		Neg No:		Hinge	
Description		6-11 BURIAL		Bracket	
Discussion				Fixing nails	
Shape, dimensions and distinguishing characteristics				Shroud pins	
LID				Fabric	
HEAD				Other finds	
BASE					
Recorder: JH		Date: 18/10/00		Initials:	

SITE	COFFIN RECORD SHEET	CONTEXT NO.
0LR00	Additional sheets: YES x1.	682
Trench: 8	Grave fills	Treatment: BONE COLLECTED
Site sub-div: NC	Grave cut:	Finds
Plan no: 3	Skeleton: 682	None
Section no:	Matrix location: 681	Breastplate
Co-ordinates:	682	Grip
Levels	683	Hinge
Slide No.	Preservation: GOOD	Bracket
	Neg No:	Fixing nails
		Shroud pins
		Fabric
		Other finds
Description 6-W Adult		
Discussion		
Shape, dimensions and distinguishing characteristics		
LID		
HEAD		
BASE		
Recorder: JH	Date: 18/10/00	Initials:



# Coffin Recording Sheet

Site Code

Context

0200

682

**Outer Coffin**

Sample Ret.

Recording Date ..... 2/12/00 .....

Associated Numbers .....

Condition .....

Dep. Plate

Legible

Inscription

Fabric lead       ormolou       brass       tin plated pewter       gilt tin   
 iron       silvered tin       enamelled       other .....      Sample Ret.

**Shape of dep. plate**

square       rectangle       shield       tapered       lozenge   
 cartouche       oval       other .....

**Upholstery**

colour .....      shoddy       velvet       other .....      Sample Ret.

**Construction**

butt joint       mitred       pitched       other .....

**Grip plate**

Fabric = ormolou       brass       tin plated pewter       gilt tin   
 iron       silvered tin       enamelled       other .....      Sample Ret.

*Frags on rev of grip - parcel 24*

**Grip**

Fabric = ormolou       brass       iron  x 4      Sample Ret.

**Design**

swag of rose       horseshoe       cherub's head       (5) (5) S      plain

other .....

**Grip bolts**

**Corner bolts**       Type =      gilt brass       brass       iron

other .....      Sample Ret.

**Lid motifs**

other .....      Sample Ret.

**Escutcheons**

other .....      Sample Ret.

**Upholstery nails**

brass       gilt brass       silvered brass       iron       enamelled

other .....      Sample Ret.

**Fixings**

panel nails       screws       hinges       lace       Sample Ret.

**Timber type** .....

Sample Ret.

**Interpretation / Comments**

.....  
 .....

**Outer Coffin**

Sample Ret.

Site Code

Context

OKR00

682

Recording Date ..... 22/2/01 .....

Associated Numbers .....

Condition .....

Dep. Plate

Legible

Inscription

Fabric lead  ormolou  brass  tin plated pewter  gilt tin   
 iron  silvered tin  enamelled  other ..... Sample Ret.

**Shape of dep. plate**

square  rectangle  shield  tapered  lozenge   
 cartouche  oval  other .....

**Upholstery**

colour ..... shoddy  velvet  other ..... Sample Ret.

**Construction**

butt joint  mitred  pitched  other .....

Grip plate  Fabric = ormolou  brass  tin plated pewter  gilt tin   
 iron  silvered tin  enamelled  other ..... Sample Ret.   
*Frag on rev of grip - frags of 3*

Grip  Fabric = ormolou  brass  iron  x4 Sample Ret.

Design swag of rose  horseshoe  cherub's head  plain   
 other ..... *2 x 1's*  
*2 x 4's*

Grip bolts  Corner bolts  Type = gilt brass  brass  iron

other ..... Sample Ret.

Lid motifs  other ..... Sample Ret.

Escutcheons  other ..... Sample Ret.

Upholstery nails  brass  gilt brass  silvered brass  iron  enamelled

other ..... Sample Ret.

Fixings  panel nails  screws  hinges  lace  Sample Ret.

Timber type ..... Sample Ret.

**Interpretation / Comments**

.....  
 .....

SITE 0LR00	COFFIN RECORD SHEET	CONTEXT NO. 683
Trench:	Additional sheets:	Treatment:
Site sub-div: NC	Grave fills	BONES COLLECTED
Plan no: 3	Grave cut:	Finds None
Section no:	Skeleton: 683	Breastplate Grip
Co-ordinates:	Matrix location: 682   683	Hinge Bracket
Levels	Preservation: Good	Fixing nails Shroud pins
Slide No.	Neg No: Photos of pathological lesion: Film 36, 2-5.	Fabric Other finds

Description  
6-w Adult

Discussion  
 Extra bones:  
 L + R 2nd MC  
 L + R 1st MC  
 L Scaphoid  
 R Trapezium  
 L Hamate } Adult - all from the same individuals, 682?

Shape, dimensions and distinguishing characteristics

LID

HEAD

BASE

Recorder: JHW	Date: 18/10/00	Initials:
---------------	----------------	-----------

SITE	COFFIN RECORD SHEET	CONTEXT NO.
BZR 00		684
Trench:	Additional sheets:	Treatment: Bones collected.
Site sub-div: NC	Grave fills /	
Plan no: 3	Grave cut: /	Finds None
Section no:	Skeleton: 684	Breastplate Grip
Co-ordinates:	Matrix location: 684 685	Hinge Bracket
Levels	Preservation: poor.	Fixing nails Shroud pins
Slide No.	Neg No:	Fabric Other finds :
<p>Description: E-W Adult burial, fairly poor bone preservation</p> <p>Discussion:</p>		
<p>Shape, dimensions and distinguishing characteristics</p> <p>LID</p> <p>HEAD</p> <p>BASE</p>		
Recorder: D HAM	Date: 18.10.00.	Initials:

SITE	COFFIN RECORD SHEET	CONTEXT NO.
Trench:	Additional sheets:	Treatment:
Site sub-div: NC	Grave fills /	Bones collected.
Plan no: 3	Grave cut: /	Finds None
Section no:	Skeleton: 685	Breastplate <input checked="" type="checkbox"/> Grip
Co-ordinates:	Matrix location: 684 685	Hinge Bracket
Levels	Preservation: FAIR <del>684</del> 692	Fixing nails Shroud pins
Slide No.	Neg No:	Fabric Other finds
<b>Description</b> E-W Adult burial, better preserved than 684.		
<b>Discussion</b>		
<b>Shape, dimensions and distinguishing characteristics</b>  LID  HEAD  BASE		
Recorder: D. How	Date: 18.10.00.	Initials:

**Outer Coffin**

Sample Ret.

Site Code

Context

Recording Date ..... 22/2/01 .....

Oh100

685

Associated Numbers .....

Condition ..... 1 .....

Dep. Plate

Legible  No

Inscription 7 x frags flat Fe plate w/ traces of characters & pass. diagnostic pieces from (6) or (43)

Fabric lead  ormolou  brass  tin plated pewter  gilt tin   
 iron  silvered tin  enamelled  other ..... Sample Ret.

Shape of dep. plate ?

square  rectangle  shield  tapered  lozenge   
 cartouche  oval  other .....

Upholstery

colour ..... shoddy  velvet  other ..... Sample Ret.

Construction butt joint  mitred  pitched  other .....

Grip plate  Fabric = ormolou  brass  tin plated pewter  gilt tin   
 iron  Frags of (6) silvered tin  enamelled  other ..... Sample Ret.

Grip  Fabric = ormolou  brass  iron  x3 Sample Ret.

Design swag of rose  horseshoe  cherub's head  (20's) plain   
 other .....

Grip bolts  Corner bolts  Type = gilt brass  brass  iron

other ..... Sample Ret.

Lid motifs  other ..... Sample Ret.

Escutcheons  other ..... Sample Ret.

Upholstery nails  brass  gilt brass  silvered brass  iron  enamelled   
 other ..... Sample Ret.

Fixings  panel nails  screws  hinges  lace  Sample Ret.

Timber type ..... Sample Ret.

Interpretation / Comments

1 x shroud pin.

SITE <i>OLR 00</i>		COFFIN RECORD SHEET	CONTEXT NO. <i>686</i>
Trench:	Additional sheets:	Treatment: <i>Bones collected.</i>	
Site sub-div: <i>NC</i>	Grave fills <i>/</i>		
Plan no: <i>3</i>	Grave cut: <i>/</i>	Finds None	
Section no:	Skeleton: <i>686</i>	Breastplate Grip <i>/</i>	
Co-ordinates:	Matrix location: <i>686</i> <i>689</i>	Hinge Bracket	
Levels	Preservation: <i>Good.</i>	Fixing nails Shroud pins	
Slide No.	Neg No:	Fabric Other finds	
Description <i>E-W Adolescent burial - unfused epiphyses.</i>			
Discussion			
Shape, dimensions and distinguishing characteristics			
<div style="display: flex; justify-content: space-between;"> <div style="width: 20%;"> <p>LID</p> <p>HEAD</p> <p>BASE</p> </div> <div style="width: 80%; text-align: right;">  </div> </div>			
Recorder: <i>D. H. M.</i>	Date: <i>18.10.50.</i>	Initials:	

# Coffin Recording Sheet

Site Code

Context

**Outer Coffin**

Sample Ret.

0H200

686

Recording Date ..... 22/2/01 .....

Associated Numbers .....

Condition .....

Dep. Plate

Legible

Inscription

Fabric lead       ormolou       brass       tin plated pewter       gilt tin   
 iron       silvered tin       enamelled       other .....      Sample Ret.

**Shape of dep. plate**

square       rectangle       shield       tapered       lozenge   
 cartouche       oval       other .....

**Upholstery**

colour .....      shoddy       velvet       other .....      Sample Ret.

**Construction**

butt joint       mitred       pitched       other .....

**Grip plate**

Fabric = ormolou       brass       tin plated pewter       gilt tin   
*fragments of grip-wood*  
 iron  silvered tin       enamelled       other .....      Sample Ret.

**Grip**

Fabric = ormolou       brass       iron  <sup>x3</sup>      Sample Ret.

**Design**

swag of rose       horseshoe       cherub's head       ~~3b~~ 3b      plain

other .....

**Grip bolts**

**Corner bolts**       Type =      gilt brass       brass       iron

other .....      Sample Ret.

**Lid motifs**

other .....

Sample Ret.

**Escutcheons**

other .....

Sample Ret.

**Upholstery nails**

brass       gilt brass       silvered brass       iron       enamelled

other .....      Sample Ret.

**Fixings**

panel nails       screws       hinges       lace       Sample Ret.

**Timber type**

.....      Sample Ret.

**Interpretation / Comments**

.....  
 .....



SITE <i>OUR 00</i>		COFFIN RECORD SHEET	CONTEXT NO. <i>687</i>
Trench:	Additional sheets:	Treatment: <i>Bone collected</i>	
Site sub-div: <i>NZ</i>	Grave fills: <i>/</i>		
Plan no: <i>3</i>	Grave cut: <i>/</i>	Finds None	
Section no:	Skeleton: <i>688</i>	Breastplate Grip	
Co-ordinates:	Matrix location: <del>687</del> <del>688</del> <i>(687)</i>	Hinge Bracket	
Levels	Preservation: <i>Good</i>	Fixing nails Shroud pins	
Slide No.	Neg No:	Fabric Other finds	
Description: <i>E-W Adult burial. No relationships.</i>			
Discussion			
Shape, dimensions and distinguishing characteristics			
LID			
HEAD			
BASE			
Recorder: <i>A. Ham</i>	Date: <i>18.10.00</i>	Initials:	

SITE <b>OLR 00</b>		COFFIN RECORD SHEET		CONTEXT NO. <b>688</b>	
Trench:		Additional sheets:		Treatment:	
Site sub-div: <b>NC</b>		Grave fills <input checked="" type="checkbox"/>		Bones collected.	
Plan no: <b>3</b>		Grave cut: <input checked="" type="checkbox"/>		Finds	
Section no:		Skeleton: <b>688</b>		None	
Co-ordinates:		Matrix location: <b>686</b> <b>688</b> <b>690</b>		Breastplate	
Levels		Preservation: <b>Good.</b>		Grip	
Slide No.		Neg No:		Hinge	
Description		E-W Adult burial.		Bracket	
Discussion				Fixing nails	
Shape, dimensions and distinguishing characteristics				Shroud pins	
LID				Fabric	
HEAD				Other finds	
BASE					
Recorder: <b>D. H. M.</b>		Date: <b>18.10.00.</b>		Initials: <b>3</b>	

**Outer Coffin**

Sample Ret.

Site Code

Context

Recording Date ..... 22/2/01 .....

Oh100

688

Associated Numbers .....

Condition .....

Dep. Plate

Legible

Inscription

Fabric lead  ormolou  brass  tin plated pewter  gilt tin   
 iron  silvered tin  enamelled  other ..... Sample Ret.

**Shape of dep. plate**

square  rectangle  shield  tapered  lozenge   
 cartouche  oval  other .....

**Upholstery**

colour ..... shoddy  velvet  other ..... Sample Ret.

**Construction**

butt joint  mitred  pitched  other .....

**Grip plate**

Fabric = ormolou  brass  tin plated pewter  gilt tin   
 iron  2286 x 1 silvered tin  enamelled  other ..... Sample Ret.

**Grip**

Fabric = ormolou  brass  iron  x 1 Sample Ret.

**Design**

swag of rose  horseshoe  cherub's head  2280. plain

other .....

**Grip bolts**

**Corner bolts**  Type = gilt brass  brass  iron

other ..... Sample Ret.

**Lid motifs**

other ..... Sample Ret.

**Escutcheons**

other ..... Sample Ret.

**Upholstery nails**

brass  gilt brass  silvered brass  iron  enamelled

other ..... Sample Ret.

**Fixings**

panel nails  screws  hinges  lace  Sample Ret.

**Timber type**

Sample Ret.

**Interpretation / Comments**

.....  
 .....

SITE	COFFIN RECORD SHEET	CONTEXT NO.
02R00		689
Trench:	Additional sheets:	Treatment:
Site sub-div: NC	Grave fills	B.C.
Plan no: 3	Grave cut:	Finds
Section no:	Skeleton: 689	None
Co-ordinates:	Matrix location:	Breastplate
Levels	Preservation: GOOD	Grip
Slide No.	Neg No:	Hinge ✓
		Bracket
		Fixing nails
		Shroud pins
		Fabric
		Other finds

**Description** 6-W Adult

**Discussion**

**Shape, dimensions and distinguishing characteristics**

LID

HEAD

BASE

Recorder: <i>[Signature]</i>	Date: 18/10/00	Initials:
------------------------------	----------------	-----------

SITE <i>OLR 50</i>		COFFIN RECORD SHEET		CONTEXT NO. <i>690</i>	
Trench:		Additional sheets: <i>YES X1</i>		Treatment: <i>B.C.</i>	
Site sub-div: <i>NC</i>		Grave fills <i>/</i>			
Plan no: <i>3</i>		Grave cut: <i>/</i>		Finds None	
Section no:		Skeleton: <i>690</i>		Breastplate Grip	
Co-ordinates:		Matrix location: <i>688</i> <i>690</i>		Hinge Bracket	
Levels		Preservation: <i>GOOD / FAIR</i>		Fixing nails Shroud pins	
Slide No.		Neg No:		Fabric Other finds	
Description <i>E-W Adult burial w/lying 688.</i>					
Discussion					
Shape, dimensions and distinguishing characteristics					
LID					
HEAD					
BASE					
Recorder: <i>D. HAW</i>		Date: <i>18.10.50</i>		Initials:	

# Coffin Recording Sheet

Site Code

Context

**Outer Coffin**

Sample Ret.

*0400*

*690*

Recording Date ..... *13/2/01* .....

Associated Numbers .....

Condition .....

Dep. Plate

Legible

Inscription

Fabric lead  ormolou  brass  tin plated pewter  gilt tin   
 iron  silvered tin  enamelled  other ..... Sample Ret.

**Shape of dep. plate**

square  rectangle  shield  tapered  lozenge   
 cartouche  oval  other .....

**Upholstery**

colour ..... shoddy  velvet  other ..... *peacock hession on Rev. of grip* Sample Ret.

**Construction** butt joint  mitred  pitched  other .....

**Grip plate**  Fabric = ormolou  brass  tin plated pewter  gilt tin   
*1x 228b* iron  silvered tin  enamelled  other ..... Sample Ret.

**Grip**  Fabric = ormolou  brass  iron  Sample Ret.   
*1x 228a*

**Design** swag of rose  horseshoe  cherub's head  plain   
 other .....

**Grip bolts**  **Corner bolts**  **Type =** gilt brass  brass  iron   
 other ..... Sample Ret.

**Lid motifs**  other ..... Sample Ret.

**Escutcheons**  other ..... Sample Ret.

**Upholstery nails**  brass  gilt brass  silvered brass  iron  enamelled   
 other ..... Sample Ret.

**Fixings**  panel nails  screws  hinges  lace  Sample Ret.

**Timber type** ..... Sample Ret.

**Interpretation / Comments**

.....  
 .....

SITE <i>OLR 00</i>		COFFIN RECORD SHEET		CONTEXT NO. <i>691</i>	
Trench:		Additional sheets: <i>YESX1</i>		Treatment: <i>B.C.</i>	
Site sub-div: <i>NC</i>		Grave fills <i>/</i>			
Plan no: <i>3</i>		Grave cut: <i>/</i>		Finds	
Section no:		Skeleton: <i>691</i>		None	
Co-ordinates:		Matrix location: <i>(691)</i>		Breastplate	
Levels		Preservation: <i>GOOD.</i>		Grip	
Slide No.		Neg No:		Hinge	
Description				Bracket	
Discussion				Fixing nails	
Shape, dimensions and distinguishing characteristics				Shroud pins	
LID				Fabric	
HEAD				Other finds	
BASE					
Recorder: <i>D. AMM</i>		Date: <i>18.10.00</i>		Initials:	

# Coffin Recording Sheet

Site Code

Context

**Outer Coffin**

Sample Ret.

02200

691

Recording Date ..... 13/2/01 .....

Associated Numbers .....

Condition .....

Dep. Plate

Legible

Inscription

Fabric lead  ormolou  brass  tin plated pewter  gilt tin   
 iron  silvered tin  enamelled  other ..... Sample Ret.

**Shape of dep. plate**

square  rectangle  shield  tapered  lozenge   
 cartouche  oval  other .....

**Upholstery**

colour ..... shoddy  velvet  other ..... Sample Ret.

**Construction**

butt joint  mitred  pitched  other .....

Grip plate  Fabric = ormolou  brass  tin plated pewter  gilt tin   
 iron  silvered tin  enamelled  other ..... Sample Ret.

Grip  Fabric = ormolou  brass  iron  x 2 Sample Ret.

Design swag of rose  horseshoe  cherub's head  plain   
 other ..... (1) → 1x ← 0.18 ↓ 0.07 / 1x ← 0.14 ↓ 0.06 ← (4)

Grip bolts  Corner bolts  Type = gilt brass  brass  iron   
 other ..... Sample Ret.

Lid motifs  other ..... Sample Ret.

Escutcheons  other ..... Sample Ret.

Upholstery nails  brass  gilt brass  silvered brass  iron  enamelled   
 other ..... Sample Ret.

Fixings  panel nails  screws  hinges  lace  Sample Ret.

Timber type ..... Sample Ret.

**Interpretation / Comments**

.....  
 .....



SITE	COFFIN RECORD SHEET	CONTEXT NO.
OLR 00		692
Trench:	Additional sheets:	Treatment:
Site sub-div: NC	Grave fills /	B.C.
Plan no: 3	Grave cut: /	Finds
Section no:	Skeleton: 692	None
Co-ordinates:	Matrix location: 685 692	Breastplate
Levels	Preservation: GOOD.	Grip ☉
Slide No.	Neg No:	Hinge
Description	E-W Adult burial.	Bracket
Discussion		Fixing nails
Shape, dimensions and distinguishing characteristics		Shroud pins
LID		Fabric
HEAD		Other finds
BASE		
Recorder: D. Hall	Date: 18.10.00.	Initials:

**Outer Coffin**

Sample Ret.

Site Code

Context

Recording Date ..... 22/2/01 .....

OKR00

692  
~~1000~~

Associated Numbers .....

Condition .....

Dep. Plate

Legible

Inscription

Fabric lead  ormolou  brass  tin plated pewter  gilt tin   
 iron  silvered tin  enamelled  other ..... Sample Ret.

**Shape of dep. plate**

square  rectangle  shield  tapered  lozenge   
 cartouche  oval  other .....

**Upholstery**

colour ..... shoddy  velvet  other ..... Sample Ret.

**Construction**

butt joint  mitred  pitched  other .....

**Grip plate**

Fabric = ormolou  brass  tin plated pewter  gilt tin   
 iron  silvered tin  enamelled  other ..... Sample Ret.   
*Frogs on rev of grip unid.*

**Grip**

Fabric = ormolou  brass  iron  x2 Sample Ret.

**Design**

swag of rose  horseshoe  cherub's head  plain

other .....

**Grip bolts**

**Corner bolts**  Type = gilt brass  brass  iron

other ..... Sample Ret.

**Lid motifs**

other ..... Sample Ret.

**Escutcheons**

other ..... Sample Ret.

**Upholstery nails**

brass  gilt brass  silvered brass  iron  enamelled

other ..... Sample Ret.

**Fixings**

panel nails  screws  hinges  lace  Sample Ret.

**Timber type**

..... Sample Ret.

**Interpretation / Comments**

.....  
 .....

SITE	OLR 00	COFFIN RECORD SHEET	CONTEXT NO.	693
Trench:		Additional sheets:	Treatment:	B.C.
Site sub-div:	NC	Grave fills		
Plan no:	3	Grave cut:	Finds	
Section no:		Skeleton:	None	
		693	Breastplate	
			Grip	
Co-ordinates:		Matrix location:	Hinge	
		692	Bracket	
		693		
		694	Fixing nails	
Levels		Preservation:	Shroud pins	
		Good.		
Slide No.		Neg No:	Fabric	
			Other finds	
Description E-W Adult burial.				
Discussion				
Shape, dimensions and distinguishing characteristics				
LID				
HEAD				
BASE				
Recorder:	D. Ham	Date:	18.10.00.	Initials:

SITE	COFFIN RECORD SHEET	CONTEXT NO.
02R 00		694
Trench:	Additional sheets:	Treatment: B.C.
Site sub-div: NC	Grave fills /	
Plan no: 3	Grave cut: /	Finds
		None
Section no:	Skeleton: 694	Breastplate
		Grip
Co-ordinates:	Matrix location: 693 694	Hinge
		Bracket
Levels	Preservation: GOOD.	Fixing nails
		Shroud pins
Slide No.	Neg No:	Fabric
		Other finds
Description E-W Adult burial.		
Discussion		
Shape, dimensions and distinguishing characteristics		
LID		
HEAD		
BASE		
Recorder: D.H.M.	Date: 18.10.00.	Initials:

**Outer Coffin**

Sample Ret.

Site Code

Context

Recording Date ..... 21/2/01

06R00

694

Associated Numbers .....

Condition .....

Dep. Plate

Legible

Inscription

Fabric lead  ormolou  brass  tin plated pewter  gilt tin   
 iron  silvered tin  enamelled  other ..... Sample Ret.

**Shape of dep. plate**

square  rectangle  shield  tapered  lozenge   
 cartouche  oval  other .....

**Upholstery**

colour ..... shoddy  velvet  other ..... Sample Ret.

**Construction** butt joint  mitred  pitched  other .....

**Grip plate**  Fabric = ormolou  brass  tin plated pewter  gilt tin   
*Frogs on rev of grip-und*  
 iron  silvered tin  enamelled  other ..... Sample Ret.

**Grip**  Fabric = ormolou  brass  iron  Sample Ret.

**Design** swag of rose  horseshoe  cherub's head  *(23) 15* plain   
 other .....

**Grip bolts**  **Corner bolts**  **Type =** gilt brass  brass  iron   
 other ..... Sample Ret.

**Lid motifs**  other ..... Sample Ret.

**Escutcheons**  other ..... Sample Ret.

**Upholstery nails**  brass  gilt brass  silvered brass  iron  enamelled   
 other ..... Sample Ret.

**Fixings**  panel nails  screws  hinges  lace  Sample Ret.

**Timber type** ..... Sample Ret.

**Interpretation / Comments**

.....  
 .....

SITE <u>OLR 00</u>		COFFIN RECORD SHEET	CONTEXT NO. <u>695</u>
Trench:	Additional sheets:	Treatment: <u>B.C.</u>	
Site sub-div: <u>NC</u>	Grave fills: <u>/</u>		
Plan no: <u>3</u>	Grave cut: <u>/</u>	Finds None	
Section no:	Skeleton: <u>695</u>	Breastplate Grip	
Co-ordinates:	Matrix location: <u>695</u> <u>729</u> WITH <u>729</u> <u>≈ 1300</u>	Hinge Bracket	
Levels	Preservation: <u>FAIR/GOOD</u>	Fixing nails Shroud pins	
Slide No.	Neg No:	Fabric Other finds	
<p>Description <u>E-W Baby burial, of lies 729. Associated with 729, 695 being the smaller baby. Possibly mixed with channel.</u></p> <p>Discussion</p>			
<p>Shape, dimensions and distinguishing characteristics</p> <p>LID</p> <p>HEAD</p> <p>BASE</p>			
Recorder: <u>D. H. M.</u>	Date: <u>19.10.00.</u>	Initials:	

110

SITE 02100	COFFIN RECORD SHEET	CONTEXT NO. 696
Trench:	Additional sheets:	Treatment: TEETH - DUA (BONES - LIKE SPANZ)
Site sub-div: CRYPT BAY 3.	Grave fills:	Finds None
Plan no: 7	Grave cut:	Breastplate ON INNER LEAD.
Section no:	Skeleton: - Foot Bone Preservation Due to BRAN(?)	Grip
Co-ordinates:	Matrix location:	Hinge
Levels	Preservation: Corroded	Bracket
Slide No.	Neg No:	Fixing nails
		Shroud pins
		Fabric
		Other finds

Description: 10 Coffin - Soldered

Discussion

Shape, dimensions and distinguishing characteristics  
Inner Lead Plate: - (Soldered).

LID

Mr John  
Hollingshead  
Died 26<sup>th</sup> July  
1781.  
Aged 48

HEAD

BASE

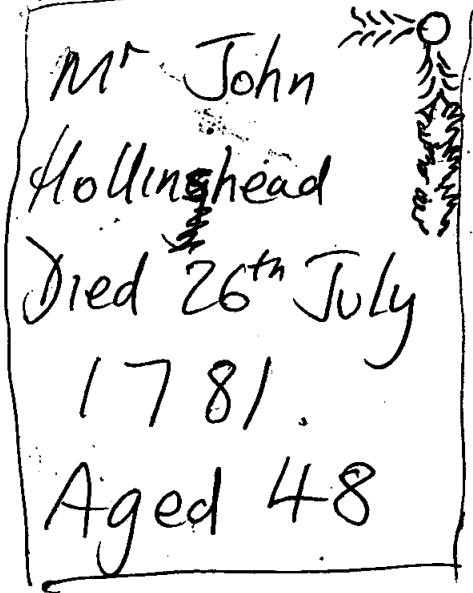
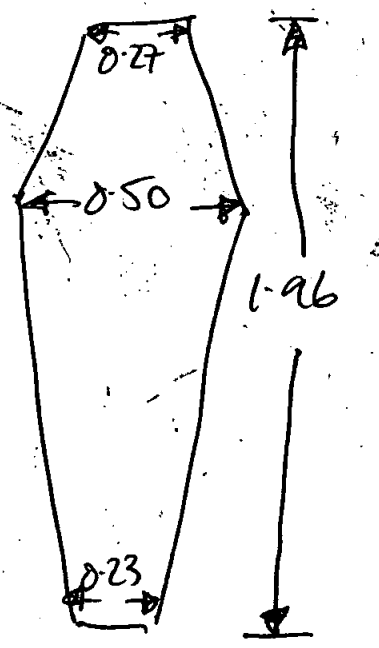
DEATH. 0.36m

Recorder: Jm Date: 17.10.00 Initials:

db

SITE 0C1200	COFFIN RECORD SHEET	CONTEXT NO. 697
Trench:	Additional sheets: YES X2	Treatment: BONES / DNT
Site sub-div: CRMP BAN 3.	Grave fills	
Plan no: 7	Grave cut:	Findings None
Section no:	Skeleton: OK	Breastplate ✓ + Inscript <sup>u</sup>
Co-ordinates:	Matrix location:	Grip
Levels:	Preservation: Poor	Hinge
Slide No.:	Neg No.:	Bracket
		Fixing nails
		Shroud pins
		Fabric
		Other finds

Description: Pb Coffin (soldered)

Discussion: BRAN.

Inscription: *Mrs Elizabeth Sewell  
Died 28<sup>th</sup> June 1839  
Age 69<sup>1/2</sup>  
Years*

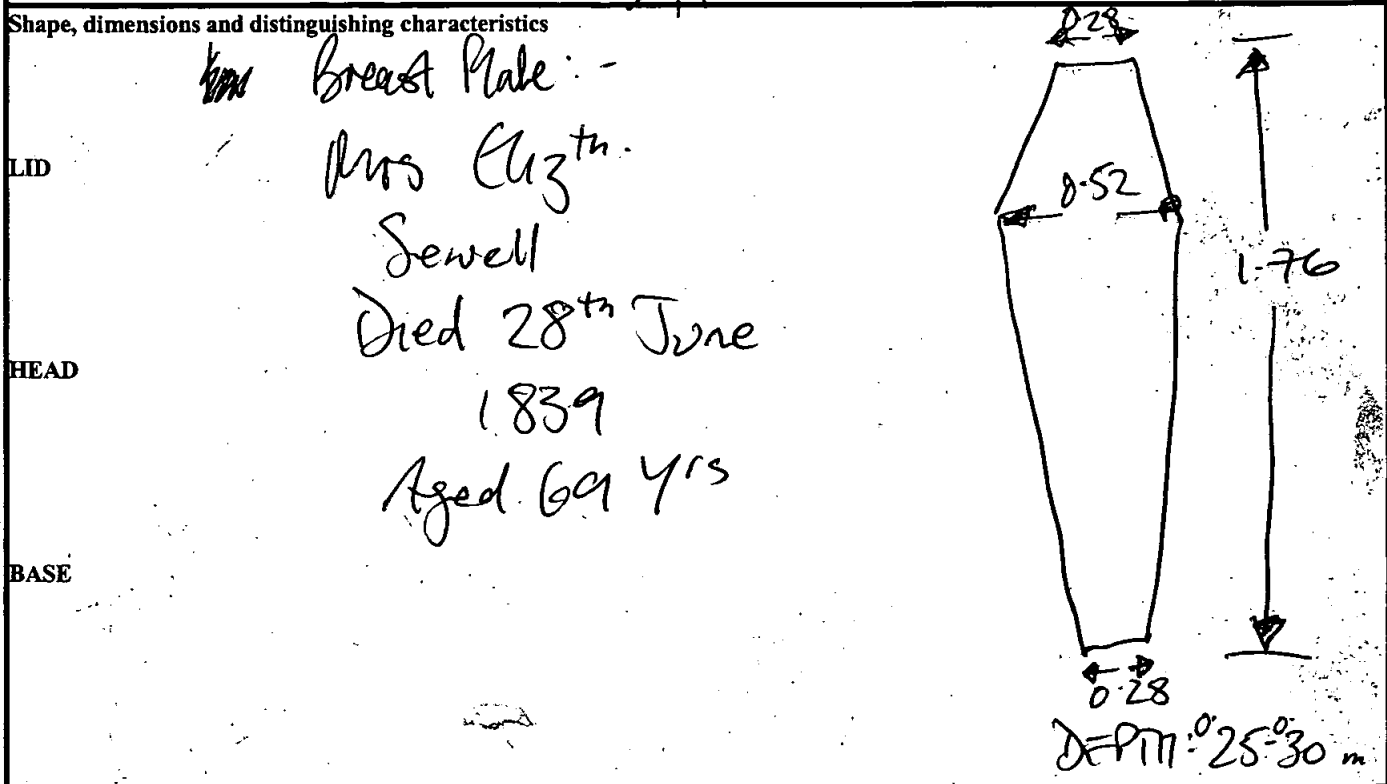

Recorder: Wm	Date: 17.10.00.	Initials:
--------------	-----------------	-----------



# Coffin Recording Sheet

Site Code

Context

OR00

697

**Outer Coffin**

Sample Ret.

Recording Date ..... 18/10 .....

Associated Numbers .....

Condition .....

Dep. Plate

Legible

Inscription *"Mrs Eliz<sup>th</sup> / Sewell / Died 28<sup>th</sup> June 1839 / Aged 69 Years"*  
*film 27 (14-16).*

*no match - new type.*

Fabric lead  ormolou  brass  tin plated pewter  gilt tin   
 iron  silvered tin  enamelled  other ..... Sample Ret.

*black polished.*

**Shape of dep. plate**

square  rectangle  shield  tapered  lozenge   
 cartouche  oval  other .....

**Upholstery**

colour ..... shoddy  velvet  other ..... Sample Ret.

**Construction**

butt joint  mitred  pitched  other .....

Grip plate  Fabric = ormolou  brass  tin plated pewter  gilt tin   
 iron  silvered tin  enamelled  other ..... Sample Ret.

Grip  Fabric = ormolou  brass  iron  x 1 Sample Ret.

Design swag of rose  horseshoe  cherub's head  plain   
 other ..... *spt fds ①*

Grip bolts  Corner bolts  Type = gilt brass  brass  iron   
 other ..... Sample Ret.

Lid motifs  other ..... Sample Ret.

Escutcheons  other ..... Sample Ret.

Upholstery nails  brass  gilt brass  silvered brass  iron  enamelled   
 other ..... Sample Ret.

Fixings  panel nails  screws  hinges  lace  Sample Ret.

Timber type ..... Sample Ret.

**Interpretation / Comments**

.....  
 .....

db

SITE DLR00	COFFIN RECORD SHEET	CONTEXT NO. 698
Trench:	Additional sheets: YES x 1	Treatment: INTACT NEEDS
Site sub-div: CAMPT BAN3	Grave fills	
Plan no: 7	Grave cut:	Finds None
Section no:	Skeleton:	Breastplate Grip ✓ x 1
Coordinates:	Matrix location: W/310	Hinge Bracket
Levels	Preservation: Good - slight holes / corrosion	Fixing nails Shroud pins
Slide No.	Neg No:	Fabric Other finds

Description Pb Coffin ~~Soldered~~ Pinned.

Discussion

Shape, dimensions and distinguishing characteristics

LID  
HEAD  
BASE

Lead Plate on Pb Coffin:-  
MMS  
Martha Smith  
Died 27th Sept  
1794  
In her 49th Year.

Recorder: <i>vm</i>	Date: 17.10.00.	Initials:
---------------------	-----------------	-----------

**Outer Coffin**

Sample Ret.

Site Code

Context

OH200

698

Recording Date ..... 18/10 .....

Associated Numbers .....

Condition .....

Dep. Plate

Legible

Inscription

Fabric lead  ormolou  brass  tin plated pewter  gilt tin   
iron  silvered tin  enamelled  other ..... Sample Ret.

**Shape of dep. plate**

square  rectangle  shield  tapered  lozenge   
cartouche  oval  other .....

**Upholstery**

colour ..... shoddy  velvet  other ..... Sample Ret.

**Construction**

butt joint  mitred  pitched  other .....

Grip plate  Fabric = ormolou  brass  tin plated pewter  gilt tin   
iron  silvered tin  enamelled  other ..... Sample Ret.

Grip  Fabric = ormolou  brass  iron  XI Sample Ret.

Design swag of rose  horseshoe  cherub's head  plain   
other ..... *① spltds*

Grip bolts  Corner bolts  Type = gilt brass  brass  iron   
other ..... Sample Ret.

Lid motifs  other ..... Sample Ret.

Escutcheons  other ..... Sample Ret.

Upholstery nails  brass  gilt brass  silvered brass  iron  enamelled   
other ..... Sample Ret.

Fixings  panel nails  screws  hinges  lace  Sample Ret.

Timber type ..... Sample Ret.

**Interpretation / Comments**

.....  
.....

db

SITE OLW0	COFFIN RECORD SHEET	CONTEXT NO. 691
Trench:	Additional sheets: YES x1	Treatment: DNA / BONE
Site sub-div: COMPT BAN 3.	Grave fills	
Plan no: 7.	Grave cut:	Finds None
Section no:	Skeleton:	Breastplate ✓ Grip
Co-ordinates:	Matrix location: u/309/311	Hinge Bracket
Levels	Preservation: Poor - Breached / Corroded.	Fixing nails Shroud pins
Slide No.	Neg No:	Fabric Other finds

Description: No Coffin Outer Lead Plate:- Thomas Millett  
 No Inscription Died 24th June 1815  
 Discussion: Shroud Aged 61

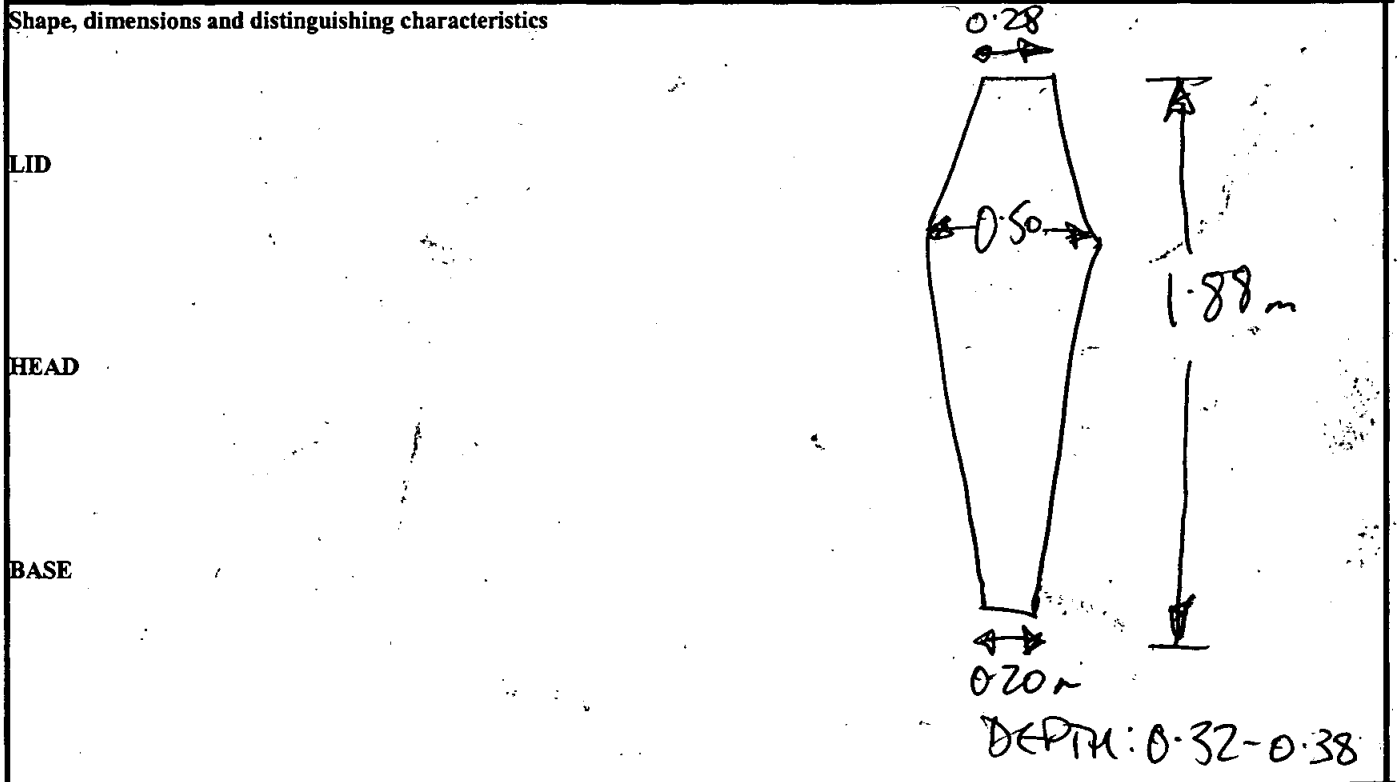

Recorder: M	Date: 17.10.00.	Initials:
-------------	-----------------	-----------

# Coffin Recording Sheet

Site Code

Context

**Outer Coffin**

Sample Ret.

02200

699

Recording Date ..... 18/10 .....

Associated Numbers .....

Condition ..... 3 .....

Dep. Plate

Legible

Inscription "Thomas Willet / Esq<sup>r</sup> / Died 24<sup>th</sup> June / 1815 / Aged 61"

Fabric lead  ormolou  brass  tin plated pewter  gilt tin   
 iron  silvered tin  enamelled  other ..... Sample Ret.

*Black polished (8) w/diff border*

**Shape of dep. plate**

square  rectangle  shield  tapered  lozenge   
 cartouche  oval  other .....

**Upholstery**

colour ..... shoddy  velvet  other ..... Sample Ret.

**Construction**

butt joint  mitred  pitched  other .....

**Grip plate**

Fabric = ormolou  brass  tin plated pewter  gilt tin

iron  silvered tin  enamelled  other ..... Sample Ret.

**Grip**

Fabric = ormolou  brass  iron  Sample Ret.

**Design**

swag of rose  horseshoe  cherub's head  plain

other .....

**Grip bolts**

Corner bolts  Type = gilt brass  brass  iron

other ..... Sample Ret.

**Lid motifs**

other ..... Sample Ret.

**Escutcheons**

other ..... Sample Ret.

**Upholstery nails**

brass  gilt brass  silvered brass  iron  enamelled

other ..... Sample Ret.

**Fixings**

panel nails  screws  hinges  lace  Sample Ret.

**Timber type** .....

Sample Ret.

**Interpretation / Comments**

.....  
 .....

Ab

SITE 82200	COFFIN RECORD SHEET	CONTEXT NO. 700
Trench:	Additional sheets:	Treatment: BONES LIFTED.
Site sub-div: CAMP BAY 3	Grave fills	
Plan no: 7	Grave cut: "	Finds None ✓
Section no:	Skeleton:	Breastplate Grip
Co-ordinates:	Matrix location: V/627	Hinge Bracket
Levels	Preservation: VERY POOR	Fixing nails Shroud pins
Slide No.	Neg No:	Fabric Other finds

Description: 16 Coffin - No NAME - SKELETON V. POORLY PRESERVED - V. LITTLE REMAINS.

Discussion

Shape, dimensions and distinguishing characteristics

LID

HEAD

BASE

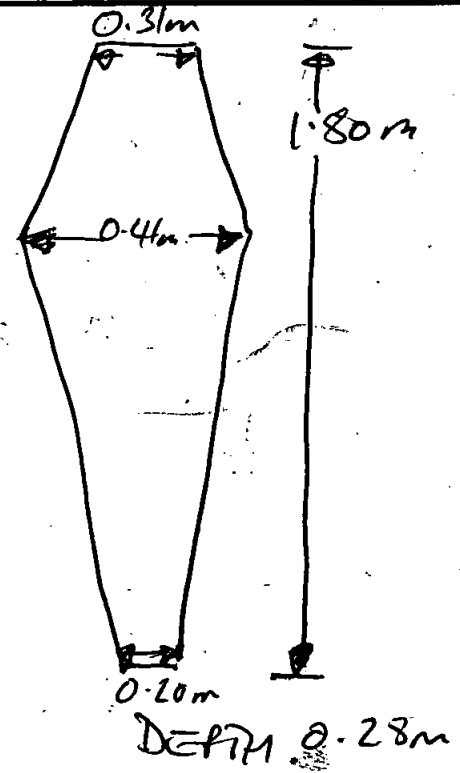

Recorder: [Signature]	Date: 17-10-00	Initials:
--------------------------	-------------------	-----------

# Coffin Recording Sheet

Site Code

Context

Oh200

700

**Outer Coffin**

Sample Ret.

Recording Date ..... *16/2/01* .....

Associated Numbers .....

Condition .....

Dep. Plate

Legible

Inscription

Fabric lead       ormolou       brass       tin plated pewter       gilt tin   
 iron       silvered tin       enamelled       other .....      Sample Ret.

**Shape of dep. plate**

square       rectangle       shield       tapered       lozenge   
 cartouche       oval       other .....

**Upholstery**

colour .....      shoddy       velvet       other .....      Sample Ret.

**Construction**

butt joint       mitred       pitched       other .....

Grip plate       Fabric = ormolou       brass       tin plated pewter       gilt tin   
 iron       silvered tin       enamelled       other .....      Sample Ret.

Grip       Fabric = ormolou       brass       iron       Sample Ret.

Design      swag of rose       horseshoe       cherub's head       plain   
 other .....

Grip bolts       Corner bolts       Type =      gilt brass       brass       iron   
 other .....      Sample Ret.

Lid motifs       other .....

Escutcheons       other .....

Upholstery <sup>studs</sup> ~~nails~~       brass       gilt brass       silvered brass       iron       enamelled   
 other ..... *1 x piece brass = 6 studs* .....      Sample Ret.

Fixings       panel nails       screws       hinges       lace       Sample Ret.

Timber type .....

**Interpretation / Comments**

.....  
 .....

db

SITE	COFFIN RECORD SHEET	CONTEXT NO.
02100		701
Trench:	Additional sheets: YES x 2.	Treatment: BONES NO DNA (YES)
Site sub-dix: CRUMPT SANDS.	Grave fills	
Plan no: 7.	Grave cut:	Finds None
Section no:	Skeleton:	Breastplate ✓ Grip
Co-ordinates:	Matrix location: u/628	Hinge Bracket
Levels	Preservation:	Fixing nails Shroud pins
Slide No.	Neg No:	Fabric Other finds

Description BREASTPLATE UNDETECTABLE. - WIDE MOUTH BURIAL, COFFIN HOLE  
 RECTANGULAR - LEAD LINED. SOLIDISED TOP & BASE. BRASS FUNDED COFFIN WITH  
 DOUBLE CROSS-LATCHINGS ON SIDES.

Discussion

Shape, dimensions and distinguishing characteristics

LID

HEAD

BASE

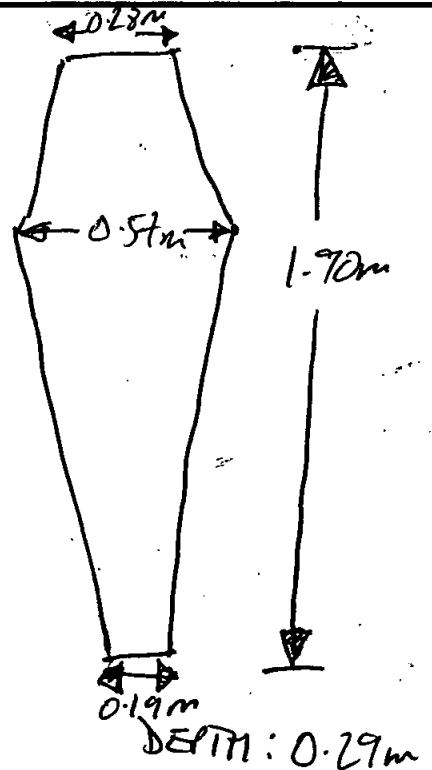

Recorder: [Signature]	Date: 17.10.00.	Initials:
-----------------------	-----------------	-----------



# Coffin Recording Sheet

Site Code

Context

02100

701

**Outer Coffin**

Sample Ret.

Recording Date ..... 26/10 .....

Associated Numbers .....

Condition ..... 2 .....

Dep. Plate  x 2 .....

Legible  ish

Inscription

Fabric lead  *x1 plated* ormolou  brass  *x1 plate b. (20)* tin plated pewter  gilt tin   
 iron  silvered tin  enamelled  other ..... Sample Ret.

**Shape of dep. plate**

square  rectangle  shield  tapered  *brass* lozenge   
 cartouche  oval  other ..... *pb shape = ? (too knackered)*

**Upholstery**

colour ..... shoddy  velvet  other ..... Sample Ret.

**Construction**

butt joint  mitred  pitched  other .....

Grip plate  Fabric = ormolou  brass  tin plated pewter  gilt tin   
 iron  silvered tin  enamelled  other ..... Sample Ret.

Grip  Fabric = ormolou  brass  iron  Sample Ret.

Design swag of rose  horseshoe  cherub's head  plain   
 other .....

Grip bolts  Corner bolts  Type = gilt brass  brass  iron   
 other ..... Sample Ret.

Lid motifs  other ..... Sample Ret.

Escutcheons  other ..... Sample Ret.

Upholstery nails  brass  gilt brass  silvered brass  iron  enamelled   
 other ..... Sample Ret.

Fixings  panel nails  screws  hinges  lace  Sample Ret.

Timber type ..... Sample Ret.

**Interpretation / Comments**

.....  
 .....

p.b. plate a.  
only part of it remaining

"Mr  
Tho<sup>s</sup> Moore  
Died .. 9<sup>th</sup> Aug."

p.b. plate b.  
poor cond.  
"

THO<sup>S</sup> MOOR  
Died 9<sup>th</sup> Aug.  
1832  
AGED  
63 years."

db

SITE	COFFIN RECORD SHEET	CONTEXT NO.
02100		702
Trench:	Additional sheets: YES x 1	Treatment:
Site sub-div: CRUBT BAY 3.	Grave fills	<del>PALEOANTHROPOLOGY</del> D NECROLOGY
Plan no: 7	Grave cut:	Finds
Section no:	Skeleton:	None
Co-ordinates:	Matrix location: u/629	Breastplate ✓
Levels	Preservation:	Grip
Slide No.	Neg No:	Hinge
		Bracket
		Fixing nails
		Shroud pins
		Fabric
		Other finds

Description E & W AUNT MURKIN. SOUTHERN B/I & BOTTOM LEAD LINES  
 CHAS. 'M' THOM [AS] MURDOON.

Discussion

Shape, dimensions and distinguishing characteristics

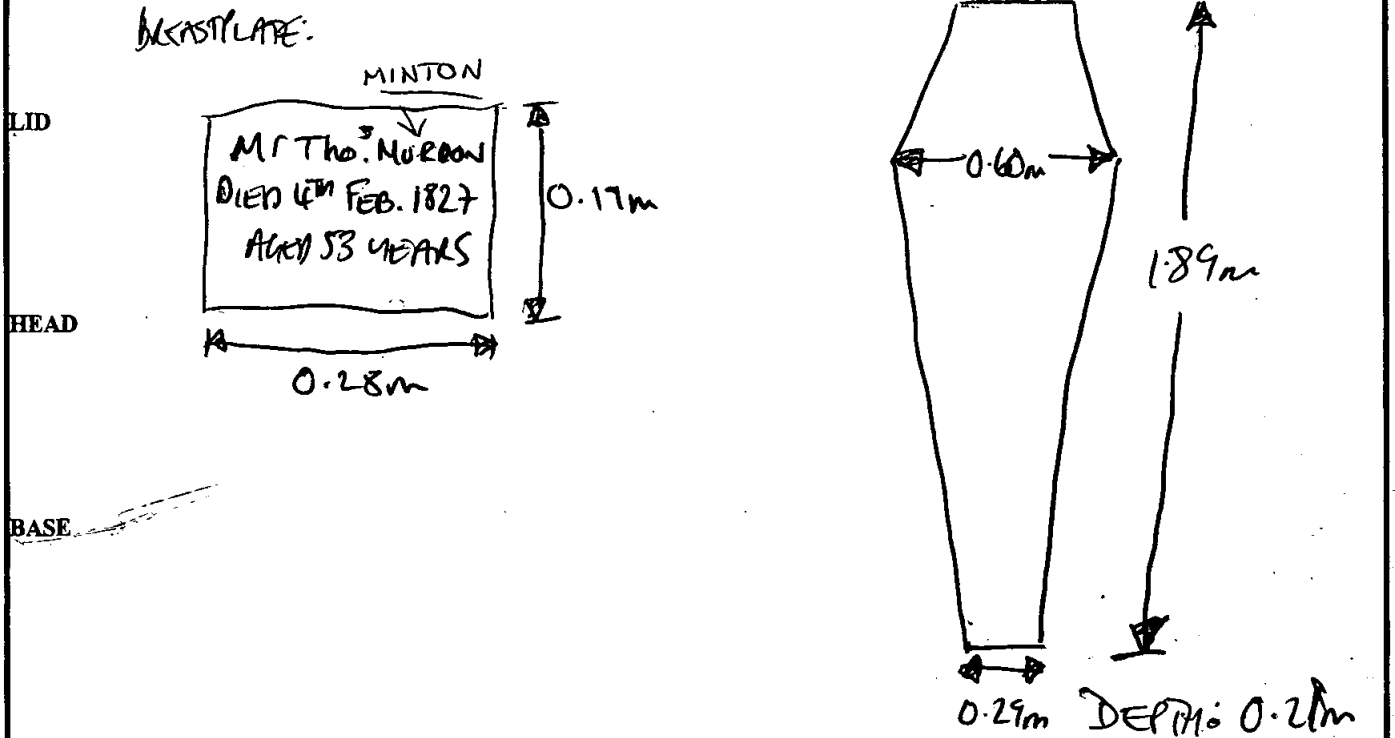

Recorder: *DM/DRM* Date: 17.10.00. Initials:

# Coffin Recording Sheet

Site Code

Context

**Outer Coffin**

Sample Ret.

OLR00

702

Recording Date ..... 18/10 .....

Associated Numbers .....

Condition .....

Dep. Plate

Legible

Inscription

Fabric lead  ormolou  brass  tin plated pewter  gilt tin   
iron  silvered tin  enamelled  other ..... Sample Ret.

**Shape of dep. plate**

square  rectangle  shield  tapered  lozenge   
cartouche  oval  other .....

**Upholstery**

colour ..... shoddy  velvet  other ..... Sample Ret.

**Construction**

butt joint  mitred  pitched  other .....

Grip plate  Fabric = ormolou  brass  tin plated pewter  gilt tin   
iron  silvered tin  enamelled  other ..... Sample Ret.

Grip  Fabric = ormolou  brass  iron  x2 Sample Ret.

Design swag of rose  horseshoe  cherub's head  plain   
other ..... conc. (A)'s (split fols).

Grip bolts  Corner bolts  Type = gilt brass  brass  iron   
other ..... Sample Ret.

Lid motifs  other ..... Sample Ret.

Escutcheons  other ..... Sample Ret.

Upholstery nails  brass  gilt brass  silvered brass  iron  enamelled   
other ..... Sample Ret.

Fixings  panel nails  screws  hinges  lace  Sample Ret.

Timber type ..... Sample Ret.

**Interpretation / Comments**

.....  
.....

db

SITE: <u>OLR00</u>	COFFIN RECORD SHEET	CONTEXT NO. <u>703</u>
Trench:	Additional sheets:	Treatment: <del>WOODEN</del> <u>BONE/DNA COLLECTED</u>
Site sub-div: <u>CAMP BAN3</u>	Grave fills:	
Plan no: <u>7</u>	Grave cut:	Finds None
Section no:	Skeleton:	Breastplate Grip
Co-ordinates:	Matrix location: <u>u/338</u>	Hinge Bracket
Levels:	Preservation:	Fixing nails Shroud pins
Slide No.:	Neg No.:	Fabric Other finds

Description NO NAME PLATE - SCAFFERED TOP & BOTTOM LEADS-LINED COFFIN.  
W & E ADULT BURIAL

Discussion

Shape, dimensions and distinguishing characteristics

LID

HEAD

BASE

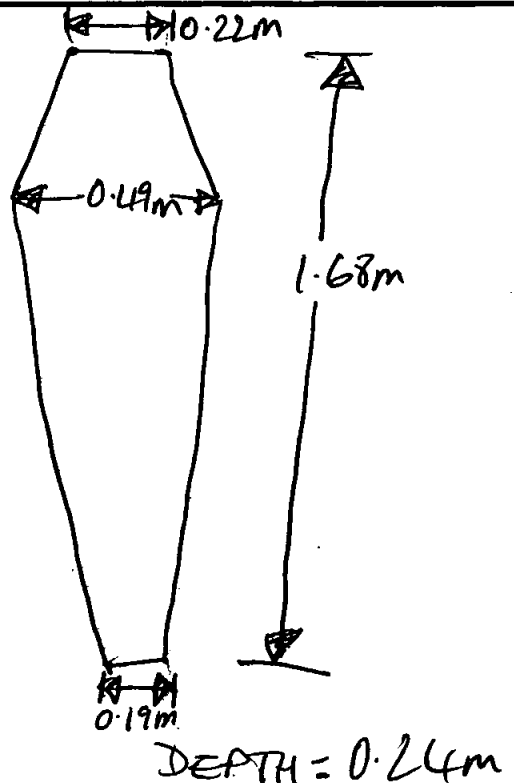

Recorder: <u>[Signature]</u>	Date: <u>17-10-00</u>	Initials:
------------------------------	-----------------------	-----------

DB

SITE	COFFIN RECORD SHEET	CONTEXT NO.
02100		704
Trench:	Additional sheets:	Treatment: Bones coll./DNA.
Site sub-div: <i>cut 3m3</i>	Grave fills	
Plan no: <i>7</i>	Grave cut:	Finds None
Section no:	Skeleton:	Breastplate Grip
Co-ordinates:	Matrix location: <i>W/1000</i>	Hinge Bracket
Levels	Preservation:	Fixing nails Shroud pins
Slide No.	Neg No:	Fabric Other finds

Description ~~FAVOR~~ N → E ADULT BURIAL. LEAD-LINED COFFIN SOLDERED RIF & BOTTOM - INNER NAIL WITHIN COFFIN SECURED TO BONES TO COFFIN SHAPE - 5 VERTICAL CUTS. BURIAL HAS SHROUD REMAINS OVER ENTIRE SKELETON

Discussion

Shape, dimensions and distinguishing characteristics

BREASTPLATE:

LID

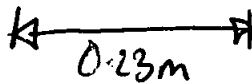
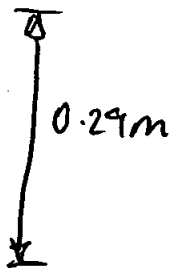
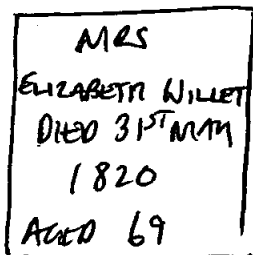

HEAD

BASE

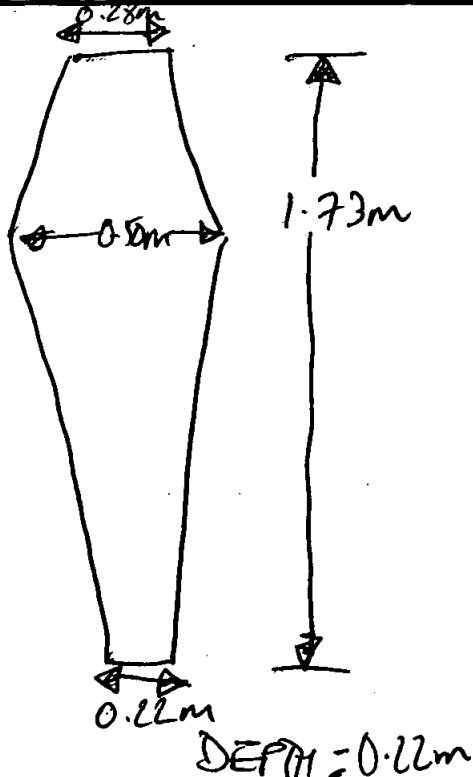

Recorder: *Dn/AM*

Date: 17.10.00

Initials:

dp

SITE 0200	COFFIN RECORD SHEET	CONTEXT NO. 705
Trench:	Additional sheets: 4/28 x 1	Treatment: buried in / DNA
Site sub-div: CANT BAY 3.	Grave fills	
Plan no: 7.	Grave cut:	Finds None
Section no:	Skeleton:	Breastplate Grip ✓
Co-ordinates:	Matrix location: 4/270.	Hinge Bracket
Levels	Preservation:	Fixing nails Shroud pins
Slide No.	Neg No:	Fabric Other finds

Description W-DE ADULT DURAL. LEAD-LINED coffin SOLID TOP & BASE.  
SHROUD REMAINS OVER ENTIRE SKELETON

Discussion

Shape, dimensions and distinguishing characteristics

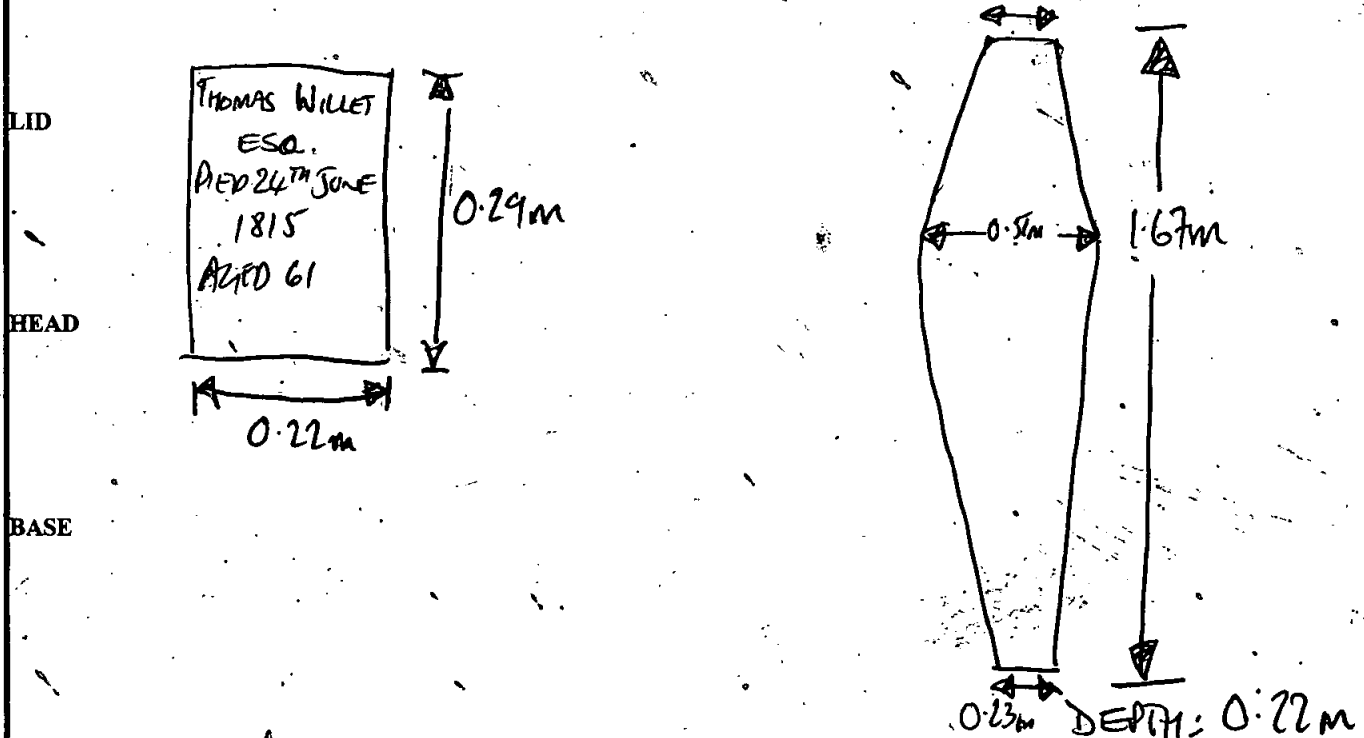

Recorder: [Signature] Date: 17. 6. 00. Initials:

# Coffin Recording Sheet

**Outer Coffin**

Sample Ret.

Site Code

Context

AR00

705

Recording Date ..... 18/10

Associated Numbers .....

Condition .....

Dep. Plate

Legible

Inscription

Fabric lead  ormolou  brass  tin plated pewter  gilt tin   
 iron  silvered tin  enamelled  other ..... Sample Ret.

**Shape of dep. plate**

square  rectangle  shield  tapered  lozenge   
 cartouche  oval  other .....

**Upholstery**

colour ..... shoddy  velvet  other ..... Sample Ret.

**Construction**

butt joint  mitred  pitched  other .....

Grip plate  Fabric = ormolou  brass  tin plated pewter  gilt tin   
 iron  silvered tin  enamelled  other ..... Sample Ret.

Grip  Fabric = ormolou  brass  iron  x1 Sample Ret.

Design swag of rose  horseshoe  cherub's head  (A) spfdds. plain   
 other .....

Grip bolts  Corner bolts  Type = gilt brass  brass  iron   
 other ..... Sample Ret.

Lid motifs  other ..... Sample Ret.

Escutcheons  other ..... Sample Ret.

Upholstery nails  brass  gilt brass  silvered brass  iron  enamelled   
 other ..... Sample Ret.

Fixings  panel nails  screws  hinges  lace  Sample Ret.

Timber type ..... Sample Ret.

**Interpretation / Comments**

.....  
 .....



db-

TE 04200		COFFIN RECORD SHEET	CONTEXT NO. 706
Trench:	Additional sheets: YES x1	Treatment: <i>Lead/Lead lined</i>	
Site sub-div: <i>CRUPT BAY 3</i>	Grave fills		
Plan no: <i>7</i>	Grave cut:	Finds: None	
Section no:	Skeleton:	Breastplate <input checked="" type="checkbox"/> Grip <input checked="" type="checkbox"/>	
Co-ordinates:	Matrix location: <i>(696)</i> <i>(706)</i>	Hinge <input type="checkbox"/> Bracket <input type="checkbox"/>	
Levels:	Preservation:	Fixing nails <input type="checkbox"/> Shroud pins <input type="checkbox"/>	
Slide No.:	Neg No.:	Fabric <input type="checkbox"/> Other finds <input type="checkbox"/>	

Description: *E-W ADULT BURIAL - LEAD LINED COFFIN, SOLDERED TOP & BASE. SOLDERED COFFIN PLATE. COFFIN FURNITURE PRESENT. \* = COFFIN HANDLES.*

Discussion

Shape, dimensions and distinguishing characteristics

ID PLATE:

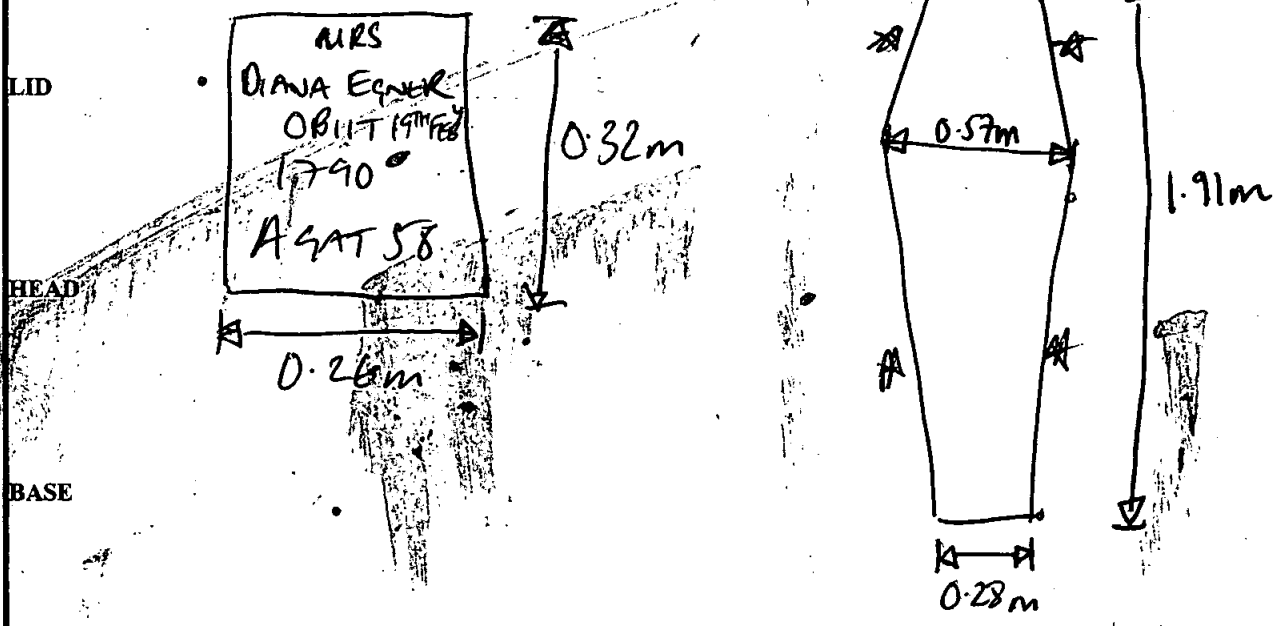

Recorder: *BM* Date: *19/10/00* Initials: *DEPTN =*

**Outer Coffin**

Sample Ret.

Site Code

Context

OH200

706

Recording Date ..... 18/10 .....

Associated Numbers .....

Condition .....

Dep. Plate

Legible

Inscription

Fabric lead  ormolou  brass  tin plated pewter  gilt tin   
 iron  silvered tin  enamelled  other ..... Sample Ret.

**Shape of dep. plate**

square  rectangle  shield  tapered  lozenge   
 cartouche  oval  other .....

**Upholstery**

colour ..... shoddy  velvet  other ..... Sample Ret.

**Construction**

butt joint  mitred  pitched  other .....

**Grip plate**

Fabric = ormolou  brass  tin plated pewter  gilt tin

iron  silvered tin  enamelled  other ... p.b. x 3 (3)'s ..... Sample Ret.   
*Black*

**Grip**

Fabric = ormolou  brass  iron  x 3 ..... Sample Ret.

**Design**

swag of rose  horseshoe  cherub's head  plain

other ..... (4)'s

**Grip bolts**

Corner bolts  Type = gilt brass  brass  iron

other ..... Sample Ret.

**Lid motifs**

other p.b. Clen motif; some as (600) see ..... Sample Ret.   
*600 sheet.*

**Escutcheons**

other .....

**Upholstery nails**

brass  gilt brass  silvered brass  iron  enamelled

other ..... Sample Ret.

**Fixings**

panel nails  screws  hinges  lace  Sample Ret.

**Timber type** .....

Sample Ret.

**Interpretation / Comments**

.....  
 .....

210

SITE	COFFIN RECORD SHEET	CONTEXT NO.
OUR 00		707
Trench:	Additional sheets: YES x 1	Treatment: Bones/DNA collected.
Site sub-div: CRAPT, Bm 3	Grave fills	
Plan no: 7	Grave cut:	Finds None
Section no:	Skeleton:	Breastplate <input checked="" type="checkbox"/> Grip <input checked="" type="checkbox"/>
Co-ordinates:	Matrix location: 697 707	Hinge Bracket
Levels	Preservation:	Fixing nails Shroud pins
Slide No.	Neg No:	Fabric Other finds

**Description**  
 WIDE ADULT FEMALE. LEAD LINED COFFIN, SOLDERED TOP & BASE  
 COFFIN PLATE SOLDERED - LOCATION NEXT TO COFFIN (708) - 40 YRS  
 BETWEEN TWO DIFFERENT FAMILIES - POSS. MARRIAGE? COFFIN LINING (TWO) PRESENT  
 AT APPROX. SPACED APARTS - POSS. PIECES OF FRAGMENTED SHROUD?  
**Discussion**

Shape, dimensions and distinguishing characteristics

COFFIN PLATE:

LID

HEAD

BASE

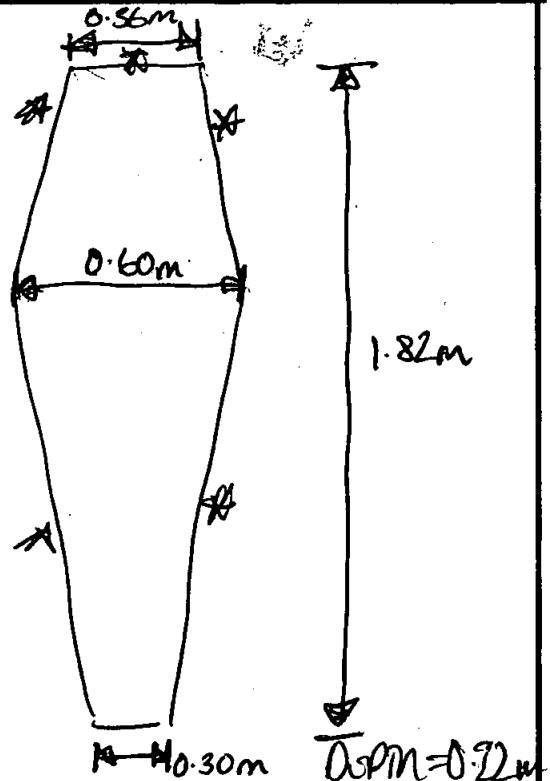
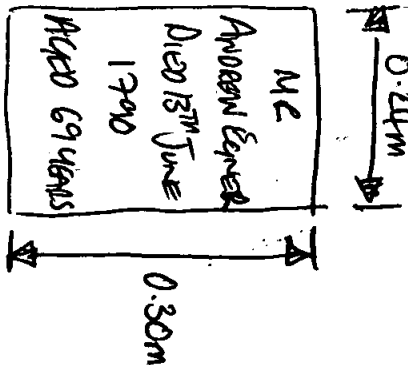

Recorder: *ARM*

Date: 17/10/00

Initials:

# Coffin Recording Sheet

**Outer Coffin**

Sample Ret.

Site Code

Context

Recording Date ..... 18/10 .....

OKR00

707

Associated Numbers .....

Condition .....

Dep. Plate

Legible

Inscription

Fabric lead  ormolou  brass  tin plated pewter  gilt tin   
iron  silvered tin  enamelled  other ..... Sample Ret.

**Shape of dep. plate**

square  rectangle  shield  tapered  lozenge   
cartouche  oval  other .....

**Upholstery**

colour ..... shoddy  velvet  other ..... Sample Ret.

**Construction**

butt joint  mitred  pitched  other .....

**Grip plate**  Fabric = ormolou  brass  tin plated pewter  gilt tin   
iron  silvered tin  enamelled  other ..... p.p. x2 sptfds ③ Sample Ret.

**Grip**  Fabric = ormolou  brass  iron  x2 Sample Ret.

**Design** swag of rose  horseshoe  cherub's head  plain   
other ..... sptfds ①

**Grip bolts**  **Corner bolts**  **Type =** gilt brass  brass  iron

other ..... Sample Ret.

**Lid motifs**  other ..... Sample Ret.

**Escutcheons**  other ..... Sample Ret.

**Upholstery nails**  brass  gilt brass  silvered brass  iron  enamelled   
other ..... Sample Ret.

**Fixings**  panel nails  screws  hinges  lace  Sample Ret.

**Timber type** ..... Sample Ret.

**Interpretation / Comments**

.....  
.....

SITE		COFFIN RECORD SHEET		CONTEXT NO.	
OLR 00				708	
Trench:		Additional sheets:		Treatment: <del>Lead</del> Neutrons	
Site sub-div: <u>Crypt, Bay 3</u>		Grave fills:		<del>Lead</del>	
Plan no: <u>7</u>		Grave cut:		Finds	
Section no:		Skeleton:		None	
Co-ordinates:		Matrix location: <u>(699)</u> <u>(708)</u>		Breastplate ✓	
Levels:		Preservation:		Grip ✓	
Slide No.:		Neg No.:		Hinge	
				Bracket	
				Fixing nails	
				Shroud pins	
				Fabric	
				Other finds	

**Description**  
 E-W ADULT BURIAL, LEAD LINED COFFIN, SOLDERED TOFF  
 BASE. BREASTPLATE PRESENT, ETCHED I.D. ON LEAD LINING. GOLD BRIDGE  
 PRESENT ON UPPER TALLATE. FOOTPLATE ALSO PRESENT AT STARKED AREA.  
 FOOTPLATE IS PINNED, NOT SOLDERED.

**Discussion**

**Shape, dimensions and distinguishing characteristics**

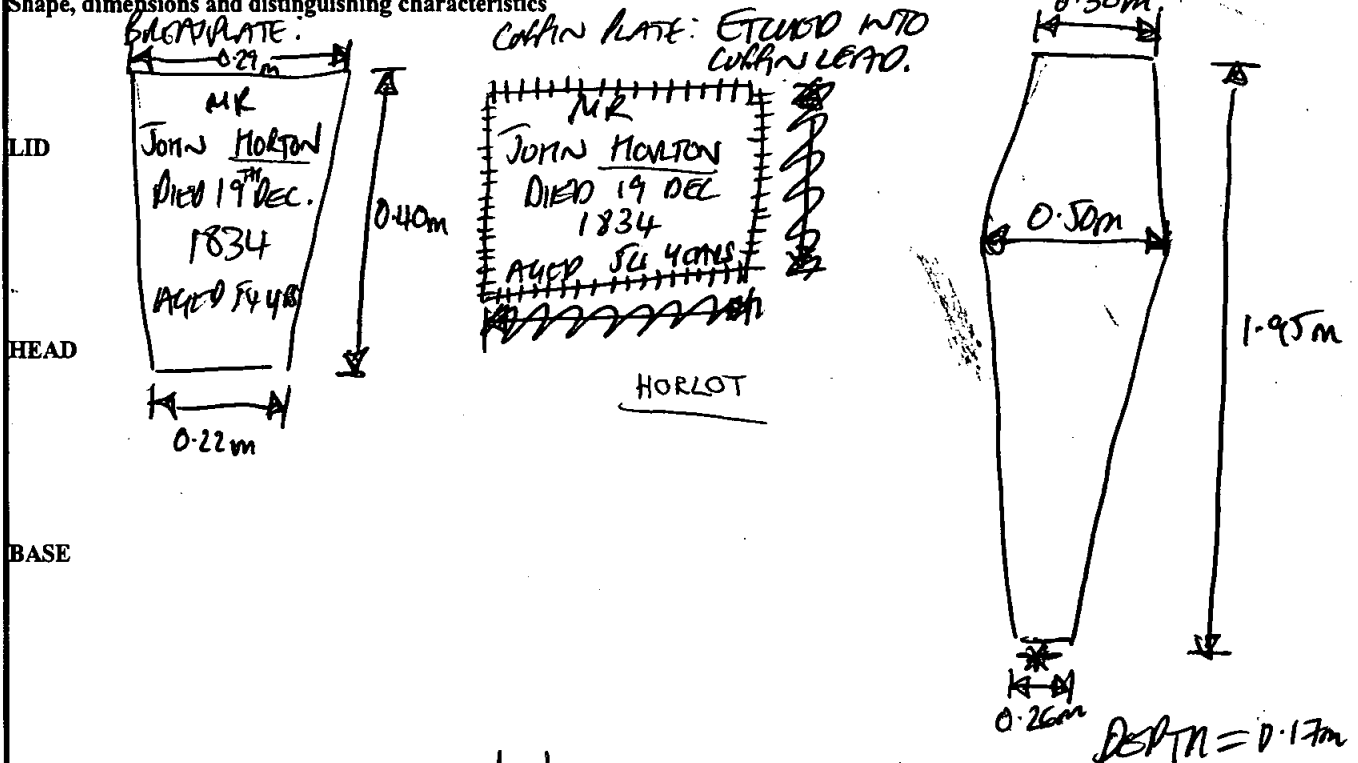

Recorder: <u>DM</u>	Date: <u>17/10/00</u>	Initials:
---------------------	-----------------------	-----------

**Outer Coffin**

Sample Ret.

Site Code

Context

Recording Date ..... 19/2/01 .....

OR00

708

Associated Numbers .....

Condition ..... 2 .....

Dep. Plate

Legible

Inscription *Mr/John Hoxton/Died 9<sup>th</sup> Dec<sup>r</sup>/1834/Aged 54 Yrs<sup>h</sup>*

*(21) w/ (23) outer border.*

Fabric lead  ormolou  brass  tin plated pewter  gilt tin   
 iron  silvered tin  enamelled  other ..... Sample Ret.

*black polished.*

**Shape of dep. plate**

square  rectangle  shield  tapered  lozenge   
 cartouche  oval  other .....

**Upholstery**

colour ..... shoddy  velvet  other ..... Sample Ret.

**Construction**

butt joint  mitred  pitched  other .....

**Grip plate**

Fabric = ormolou  brass  tin plated pewter  gilt tin

iron  silvered tin  enamelled  other ..... Sample Ret.

**Grip**

Fabric = ormolou  brass  iron  Sample Ret.

**Design**

swag of rose  horseshoe  cherub's head  plain

other .....

**Grip bolts**

Corner bolts  Type = gilt brass  brass  iron

other ..... Sample Ret.

**Lid motifs**

other .....

Sample Ret.

**Escutcheons**

other .....

Sample Ret.

**Upholstery nails**

brass  gilt brass  silvered brass  iron  enamelled

other ..... Sample Ret.

**Fixings**

panel nails  screws  hinges  lace  Sample Ret.

**Timber type** .....

Sample Ret.

**Interpretation / Comments**

.....  
 .....

SITE	COFFIN RECORD SHEET	CONTEXT NO.
OL 100		709
Trench:	Additional sheets:	Treatment:
Site sub-div: <i>Camp 3</i>	Grave fills:	<i>Bones / DNA collected</i>
Plan no: <i>7</i>	Grave cut:	Finds
Section no:	Skeleton:	None
Co-ordinates:	Matrix location: <i>(704)</i> <i>(709)</i>	Breastplate <input checked="" type="checkbox"/>
Levels:	Preservation:	Grip
Slide No.:	Neg No.:	Hinge
		Bracket
		Fixing nails
		Shroud pins
		Fabric
		Other finds

**Description** *Pb Coffin* *Breast plate* → *Mr John Horlos*  
*Soldwood 101 & 102* *Died 25th Nov 1837*  
**Discussion** *In his 23rd yr*

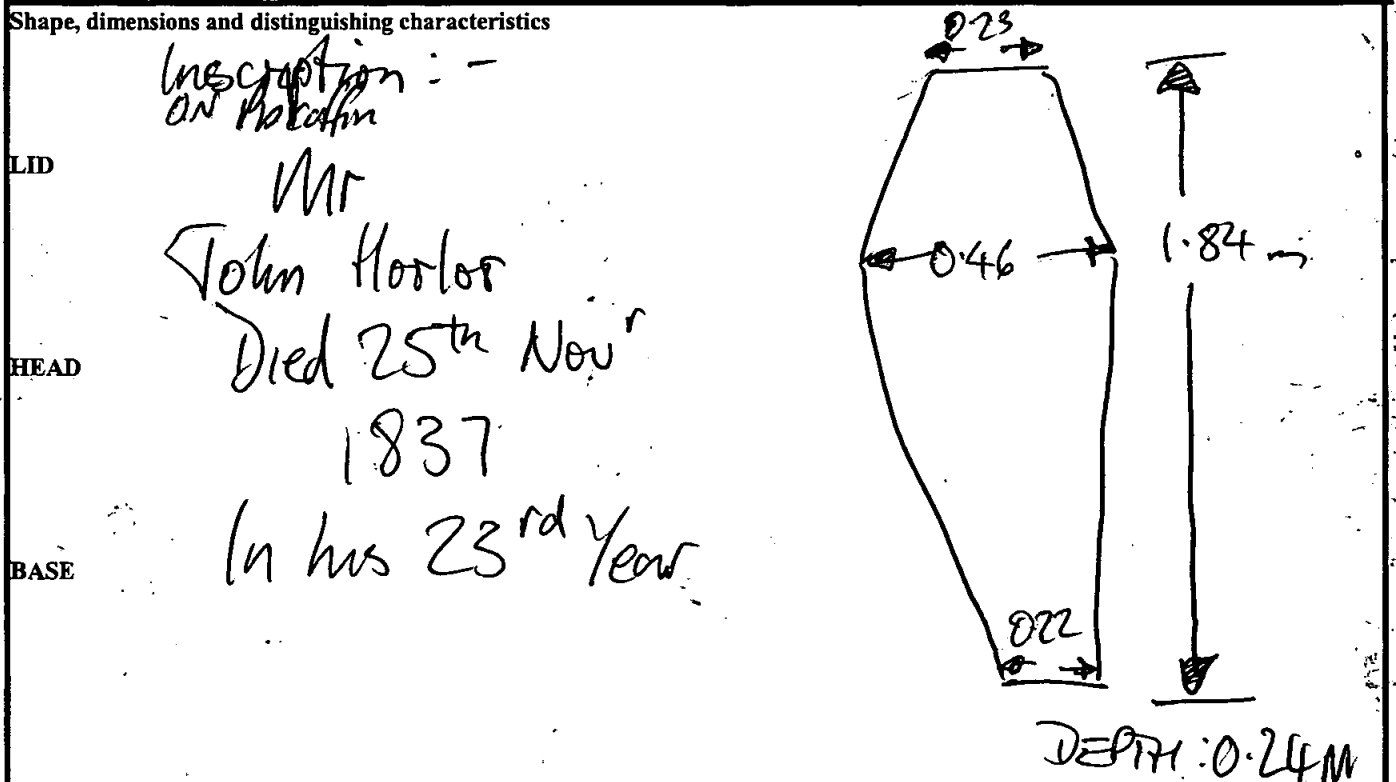

Recorder: *Dm* Date: *17.10.00* Initials:

**Outer Coffin**

Sample Ret.

Site Code

Context

Recording Date ..... 15/2/01 .....

OL200

709

Associated Numbers .....

Condition ..... 2 .....

Dep. Plate

Legible

Inscription "Mr/John ??? Lor/Died 25<sup>th</sup> Nov<sup>r</sup>/18(3)7/ In his 23<sup>rd</sup> yr"

*same as 776 w/ new outer board*

Fabric lead  ormolou  brass  tin plated pewter  gilt tin   
 iron  silvered tin  enamelled  other ..... Sample Ret.   
*black polished*

**Shape of dep. plate**

square  rectangle  shield  tapered  lozenge   
 cartouche  oval  other .....

**Upholstery**

colour ..... shoddy  velvet  other ..... Sample Ret.

**Construction**

butt joint  mitred  pitched  other .....

Grip plate  Fabric = ormolou  brass  tin plated pewter  gilt tin   
 iron  silvered tin  enamelled  other ..... Sample Ret.

Grip  Fabric = ormolou  brass  iron  x 1  Sample Ret.   
 (6)

Design swag of rose  horseshoe  cherub's head  plain   
 other .....

Grip bolts  Corner bolts  Type = gilt brass  brass  iron   
 other ..... Sample Ret.

Lid motifs  other ..... Sample Ret.

Escutcheons  other ..... Sample Ret.

Upholstery nails  brass  gilt brass  silvered brass  iron  enamelled   
 other ..... Sample Ret.

Fixings  panel nails  screws  hinges  lace  Sample Ret.

Timber type ..... Sample Ret.

**Interpretation / Comments**

.....  
 .....



Ab

SITE OLR 00	COFFIN RECORD SHEET	CONTEXT NO. 710
Trench:	Additional sheets:	Treatment:
Site sub-div: CUMPT, BAM 3	Grave fills:	NECROTOUS
Plan no: 7	Grave cut:	Finds None ✓
Section no:	Skeleton: 7	Breastplate Grip
Co-ordinates:	Matrix location: 704 710	Hinge Bracket
Levels:	Preservation: Good - at bottom top Corroded.	Fixing nails Shroud pins
Slide No.:	Neg No.:	Fabric Other finds

Description Pb Coffin - Soldered

Discussion

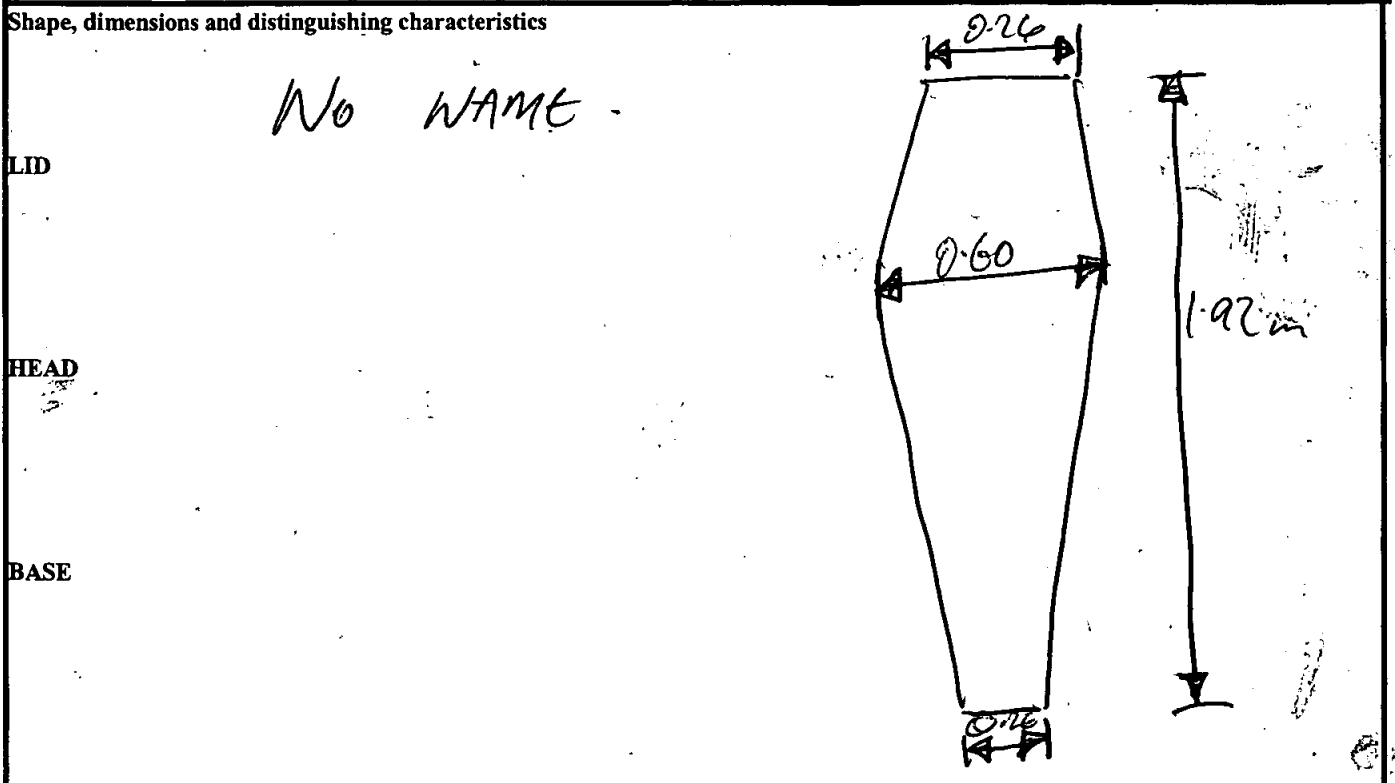

Recorder: Am	Date: 18.10.00	Initials:
--------------	----------------	-----------

SITE <del>021000</del> 021000	COFFIN RECORD SHEET	CONTEXT NO. 711
Trench:	Additional sheets:	Treatment: Burial / DNA collection
Site sub-div: CULVERT, BAY 3	Grave fills:	
Plan no: 7	Grave cut:	Finds: None
Section no:	Skeleton:	Breastplate <input checked="" type="checkbox"/> Grip
Co-ordinates:	Matrix location: 703 711	Hinge Bracket
Levels:	Preservation: V. Poor	Fixing nails Shroud pins
Slide No.:	Neg No.:	Fabric Other finds

Description: Pb coffin - lined with DE BURIAL, ADULT. Soldered top & base. Coffin fully decorated.

Discussion:

Shape, dimensions and distinguishing characteristics

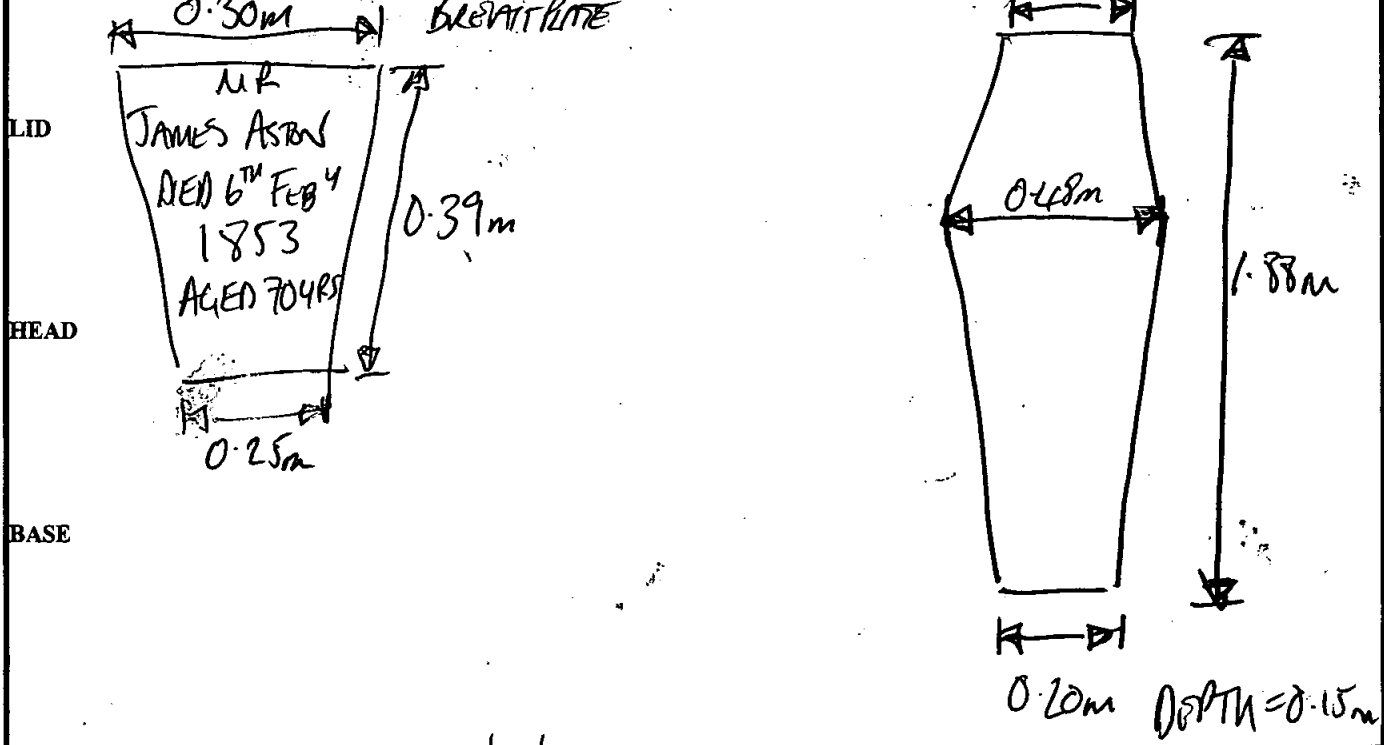

Recorder: [Signature] Date: 19/10/00 Initials:

# Coffin Recording Sheet

**Outer Coffin**

Sample Ret.

Site Code

Context

Recording Date ..... 15/2/01 .....

OK200

711

Associated Numbers .....

Condition ..... 3 .....

Dep. Plate

Legible

Inscription "MR/James Aston/Died 6<sup>th</sup> Feb<sup>y</sup>/185<sup>3</sup>/Aged 70 Years"

*new type, set sheet.*

Fabric lead     ormolou     brass     tin plated pewter     gilt tin   
 iron     silvered tin     enamelled     other .....    Sample Ret.

*black polished*

**Shape of dep. plate**

square     rectangle     shield     tapered     lozenge   
 cartouche     oval     other .....

**Upholstery**

colour .....    shoddy     velvet     other .....    Sample Ret.

**Construction**

butt joint     mitred     pitched     other .....

**Grip plate**     Fabric = ormolou     brass     tin plated pewter     gilt tin   
 iron     silvered tin     enamelled     other .....    Sample Ret.

**Grip**     Fabric = ormolou     brass     iron     Sample Ret.

**Design**    swag of rose     horseshoe     cherub's head     plain   
 other .....

**Grip bolts**     **Corner bolts**     Type = gilt brass     brass     iron   
 other .....    Sample Ret.

**Lid motifs**     other .....    Sample Ret.

**Escutcheons**     other .....    Sample Ret.

**Upholstery nails**     brass     gilt brass     silvered brass     iron     enamelled   
 other .....    Sample Ret.

**Fixings**     panel nails     screws     hinges     lace     Sample Ret.

**Timber type** .....    Sample Ret.

**Interpretation / Comments**

.....  
 .....

dp

SITE OUR 00	COFFIN RECORD SHEET	CONTEXT NO. 712
Trench:	Additional sheets:	Treatment: Bands / DNA CONDUCTED ONLY ON BONE
Site sub-div: CLUT, BOM 3	Grave fills:	Finds None ✓
Plan no: 7	Grave cut:	Breastplate
Section no:	Skeleton: 703 332 712 ↓	Grip
Co-ordinates:	Matrix location: ↓	Hinge
Levels	Preservation: GOOD (Laminar) Poor (Lined)	Bracket
Slide No.	Neg No:	Fixing nails
		Shroud pins
		Fabric
		Other finds

**Description** E-W ADULT BURIAL - LEAD-LINED COFFIN, SOLDERED TOP & BASE. EMBOSSED I.D. ON LEAD LINING AT ASTERIS. POSSIBLE REMAINS OF SHROUD ON BURIAL. SKULL, AXIS, ATLAS, SCAPULA & DELTMOID.

**Discussion**

**Shape, dimensions and distinguishing characteristics**

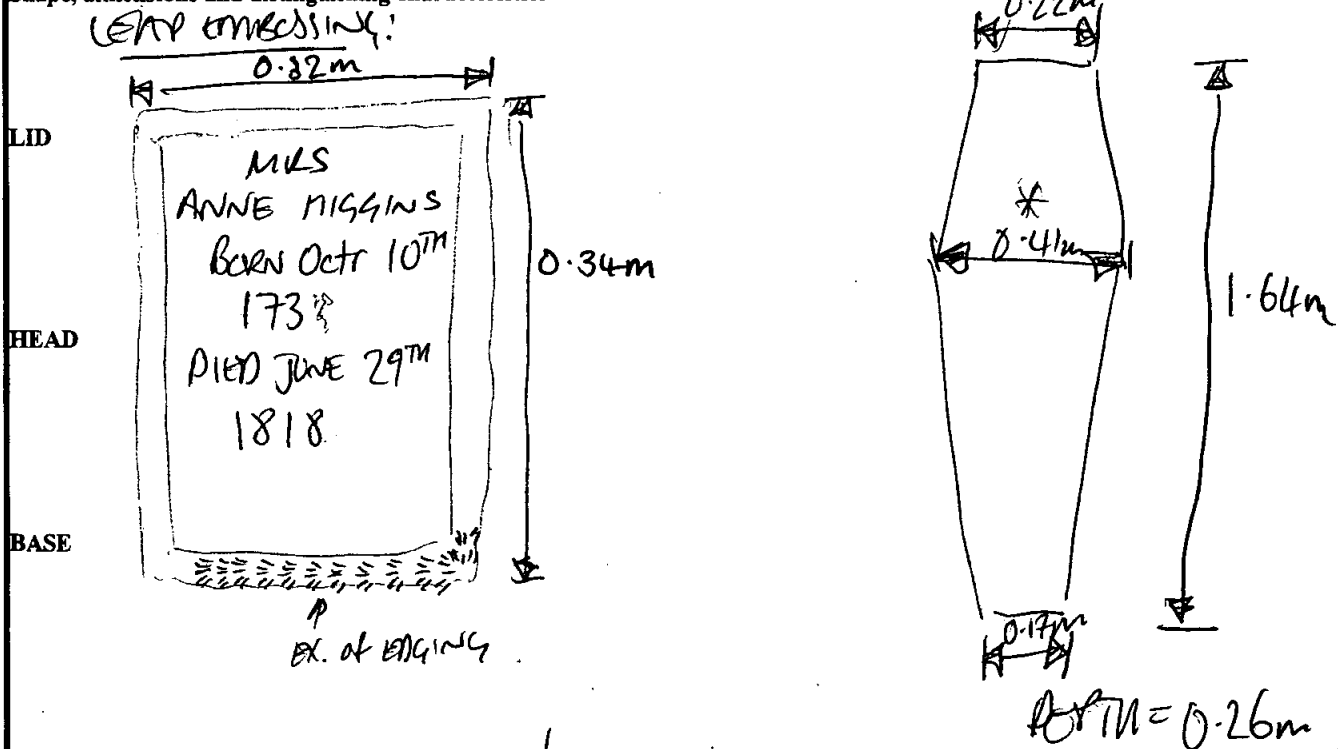

Recorder: <i>ABM</i>	Date: 18/10/00	Initials:
----------------------	----------------	-----------

db

SITE	COFFIN RECORD SHEET	CONTEXT NO.
ORR 00		713
Trench:	Additional sheets:	Treatment:
Site sub-div: CRUPT, BAN 2	Grave fills:	Bone / DNA COLLECTED
Plan no: 7	Grave cut:	Finds None
Section no:	Skeleton:	Breastplate <input checked="" type="checkbox"/>
Co-ordinates:	Matrix location:	Grip
Levels	Preservation: Good	Hinge
Slide No.	Neg No:	Bracket
		Fixing nails
		Shroud pins
		Fabric
		Other finds

Description: ~~W~~ ~~E~~ ADULT BURIAL, LEAD-LINED COFFIN. BREASTPLATE AND SOLID COFFIN PLATE. SOLID COFFIN TOP & BOTTOM. FOOTPLATE PRESENT AT 15 DEGREES. BRANDED COFFIN.

Discussion

Shape, dimensions and distinguishing characteristics

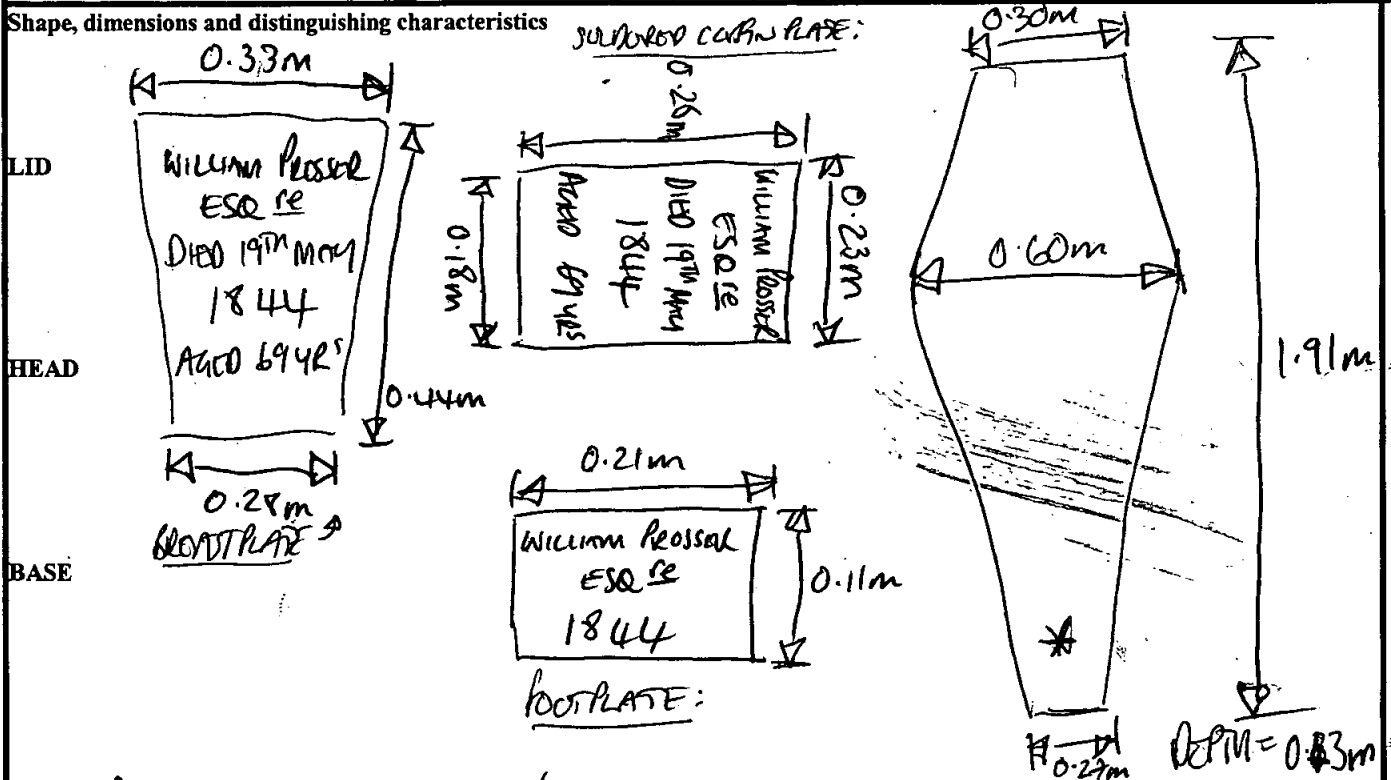

Recorder: <i>PM</i>	Date: 13/10/80	Initials:
---------------------	----------------	-----------

# Coffin Recording Sheet

Site Code

Context

**Outer Coffin**

Sample Ret.

01200

713

Recording Date ..... 18/10 .....

Associated Numbers .....

Condition .....

Dep. Plate

Legible

Inscription

*"William Prosser/ Esq<sup>RE</sup>/ Died 19<sup>th</sup> May/ 1844/ Aged 69 Years"*  
*see following sheet.*

Fabric lead  ormolou  brass  tin plated pewter  gilt tin   
iron  silvered tin  enamelled  other ..... Sample Ret.

*black polished.*

**Shape of dep. plate**

square  rectangle  shield  tapered  lozenge   
cartouche  oval  other .....

**Upholstery**

colour ..... shoddy  velvet  other ..... Sample Ret.

**Construction**

butt joint  mitred  pitched  other .....

**Grip plate**  **Fabric =** ormolou  brass  tin plated pewter  gilt tin   
iron  silvered tin  enamelled  other ..... Sample Ret.

**Grip**  **Fabric =** ormolou  brass  iron  Sample Ret.

**Design** swag of rose  horseshoe  cherub's head  plain   
other .....

**Grip bolts**  **Corner bolts**  **Type =** gilt brass  brass  iron   
other ..... Sample Ret.

**Lid motifs**  other ..... Sample Ret.

**Escutcheons**  other ..... Sample Ret.

**Upholstery nails**  brass  gilt brass  silvered brass  iron  enamelled   
other ..... Sample Ret.

**Fixings**  panel nails  screws  hinges  lace  Sample Ret.

**Timber type** ..... Sample Ret.

**Interpretation / Comments**

.....  
.....

db

SITE	COFFIN RECORD SHEET	CONTEXT NO.
OLR00	Additional sheets: YES x 1.	714
Trench:	Grave fills	Treatment: - NEOLITHIC
Site sub-div: OLRPT, BM 2	Grave cut:	Finds None
Plan no: 7	Skeleton:	Breastplate Grip ✓
Section no:	Matrix location:	Hinge Bracket
Co-ordinates:	Preservation: GOOD	Fixing nails Shroud pins
Levels	Neg No:	Fabric Other finds

**Description** E-W ADULT BURIAL. LEAD-LINED COFFIN - SOLDERED TOP & BOTTOM. "MR EDWARD SEWARD" - LEAD PLATE SOLDERED TO BREAST OF COFFIN. ESCUTIONS PRESENT AT EDGES OF COFFIN (SEE BELOW) AND STUDS.

**Discussion**

**Shape, dimensions and distinguishing characteristics**

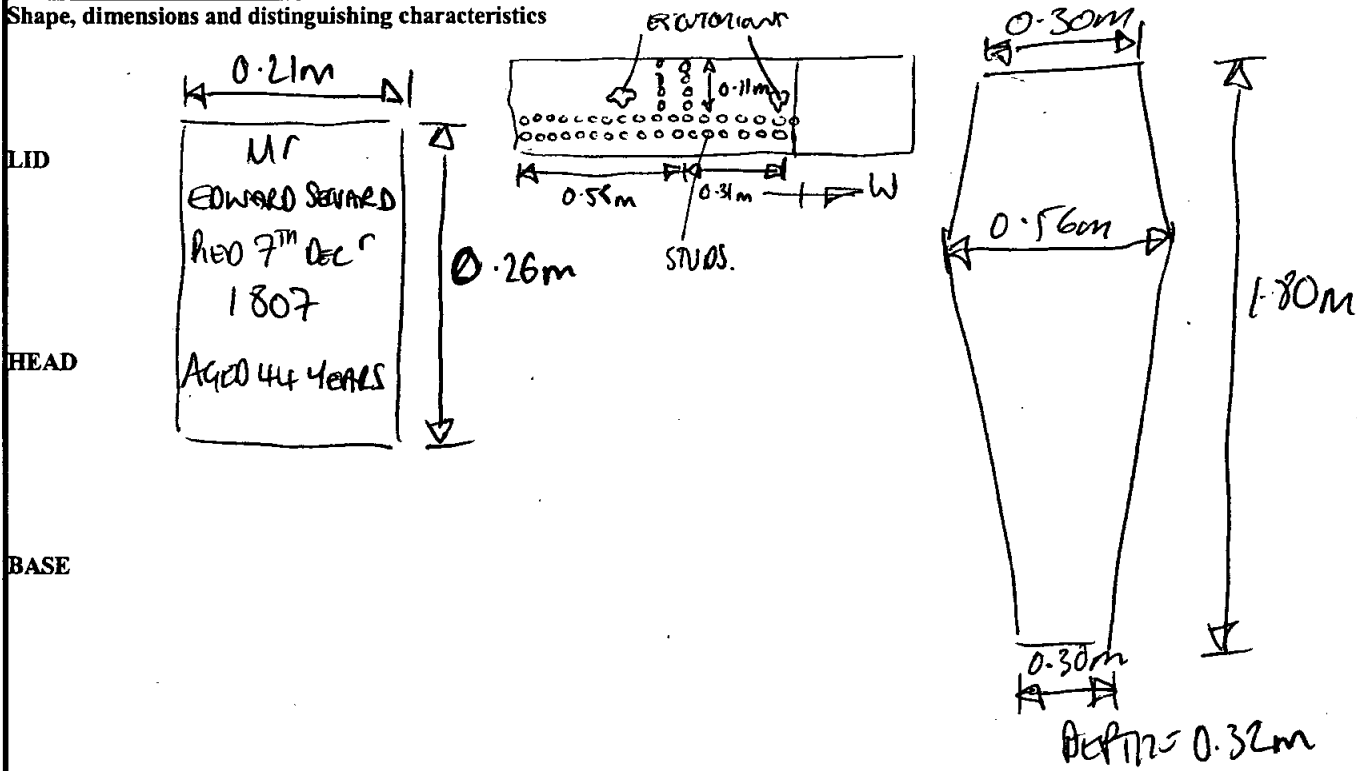

Recorder: <i>[Signature]</i>	Date: 18/10/00	Initials:
------------------------------	----------------	-----------

# Coffin Recording Sheet

Site Code

Context

**Outer Coffin**

Sample Ret.

OLR00

714

Recording Date ..... 19/10

Associated Numbers .....

Condition .....

Dep. Plate

Legible

Inscription

Fabric lead  ormolou  brass  tin plated pewter  gilt tin   
 iron  silvered tin  enamelled  other ..... Sample Ret.

**Shape of dep. plate**

square  rectangle  shield  tapered  lozenge   
 cartouche  oval  other .....

**Upholstery**

colour ..... shoddy  velvet  other *boize* ..... Sample Ret.

**Construction** butt joint  mitred  pitched  other .....

**Grip plate**  Fabric = ormolou  brass  tin plated pewter  gilt tin   
 iron  silvered tin  enamelled  other ..... Sample Ret.

**Grip**  Fabric = ormolou  brass  iron  x1 ..... Sample Ret.

**Design** swag of rose  horseshoe  cherub's head  plain   
 other .....

**Grip bolts**  **Corner bolts**  Type = gilt brass  brass  iron   
 other ..... Sample Ret.

**Lid motifs**  other .....

**Escutcheons**  other x1 *cu alloy w/ gilt* (12) ..... Sample Ret.

**Upholstery nails**  brass  gilt brass  silvered brass  iron  enamelled   
 other ..... Sample Ret.

**Fixings**  panel nails  screws  hinges  lace  Sample Ret.

**Timber type** ..... Sample Ret.

**Interpretation / Comments**

.....  
 .....



db

SITE		COFFIN RECORD SHEET	CONTEXT NO.
OLR00			715
Trench:	Additional sheets:	Treatment:	
Site sub-div: CR4PT, 6M 2	Grave fills	→ NEUROPOUS	
Plan no: 7	Grave cut:	Finds	
Section no:	Skeleton:	None	
Co-ordinates:	Matrix location:	Breastplate	
Levels	Preservation: Good	Grip	
Slide No.	Neg No:	Hinge	
		Bracket	
		Fixing nails	
		Shroud pins	
		Fabric	
		Other finds	

**Description** E-W ADULT BURIAL. LEATH-LINED SEWED TOP & BOTTOM COFFIN. BREASTPLATE PRESENT. EMBOSSED I.O. ON COFFIN BREAST ALSO.

**Discussion**

**Shape, dimensions and distinguishing characteristics**

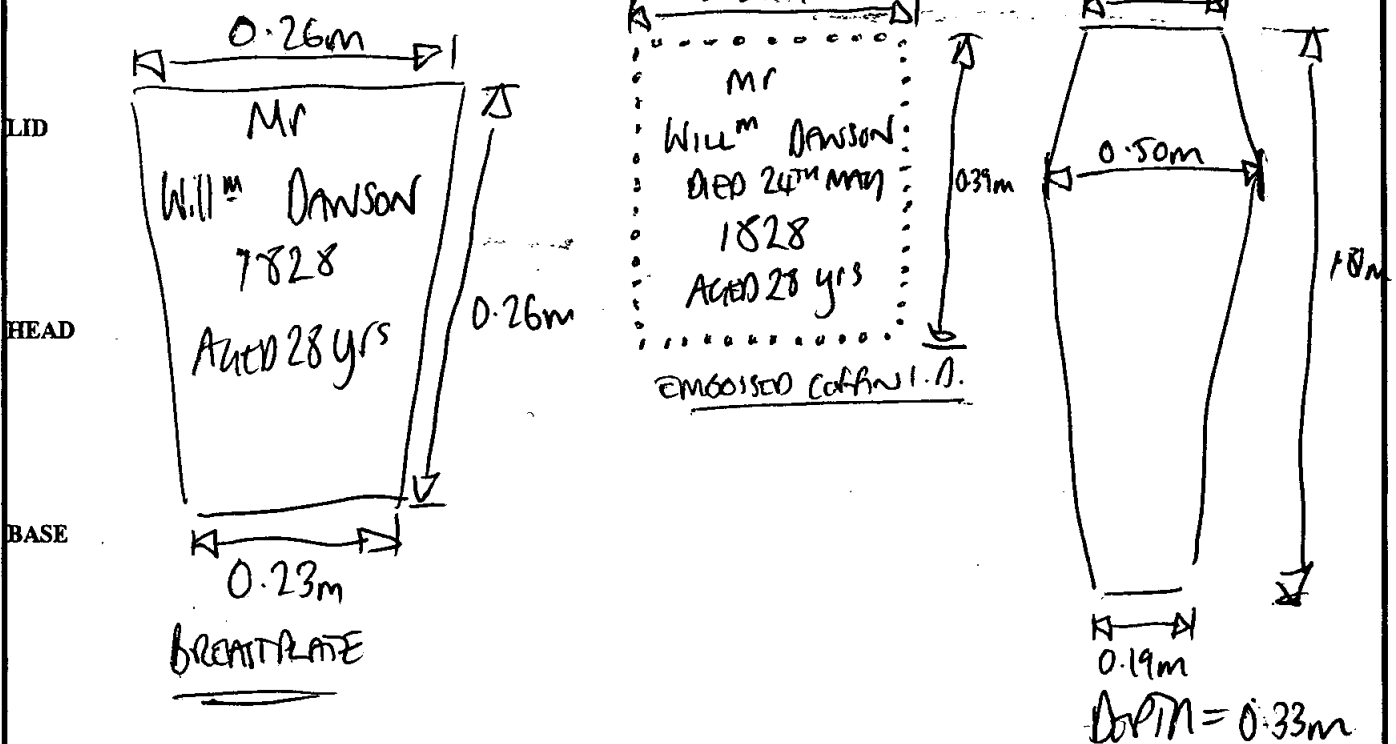

Recorder:	Date:	Initials:
-----------	-------	-----------

# Coffin Recording Sheet

Site Code

Context

OH200

715

**Outer Coffin**

Sample Ret.

Recording Date ..... 18/10 .....

Associated Numbers .....

Condition .....

Dep. Plate

Legible

Inscription "Mr/Will<sup>m</sup> Danson/Died 24<sup>th</sup> May/1828/Aged 28 Years"

Fabric lead  ormolou  brass  tin plated pewter  gilt tin   
iron  silvered tin  enamelled  other ..... Sample Ret.

**Shape of dep. plate**

square  rectangle  shield  tapered  lozenge   
cartouche  oval  other ..... (8A) w/ diff border.

**Upholstery**

colour ..... shoddy  velvet  other ..... Sample Ret.

**Construction**

butt joint  mitred  pitched  other .....

Grip plate  Fabric = ormolou  brass  tin plated pewter  gilt tin   
iron  silvered tin  enamelled  other ..... Sample Ret.

Grip  Fabric = ormolou  brass  iron  Sample Ret.

Design swag of rose  horseshoe  cherub's head  plain   
other .....

Grip bolts  Corner bolts  Type = gilt brass  brass  iron   
other ..... Sample Ret.

Lid motifs  other ..... Sample Ret.

Escutcheons  other ..... Sample Ret.

Upholstery nails  brass  gilt brass  silvered brass  iron  enamelled   
other ..... Sample Ret.

Fixings  panel nails  screws  hinges  lace  Sample Ret.

Timber type ..... Sample Ret.

**Interpretation / Comments**

.....  
.....

JP

SITE	COFFIN RECORD SHEET	CONTEXT NO.
OLR 00		716
Trench:	Additional sheets:	Treatment: <del>NECROPOLIS</del>
Site sub-div: CRUPT, BAW3 VAULT 18	Grave fills	
Plan no: 7	Grave cut:	Finds None
Section no:	Skeleton:	Breastplate Grip
Co-ordinates:	Matrix location: WEDIN VAULT 18 716 717	Hinge Bracket
Levels	Preservation: GOOD	Fixing nails Shroud pins
Slide No.	Neg No:	Fabric Other finds

Description E-W ADULT BURIAL. Pb LINED COFFIN, NOT SOLDERED TO P/BASE.  
I.D. PLATE SOLDERED TO BREAST. "WILLIAM SUTTON ESQ<sup>re</sup>".

Discussion

Shape, dimensions and distinguishing characteristics

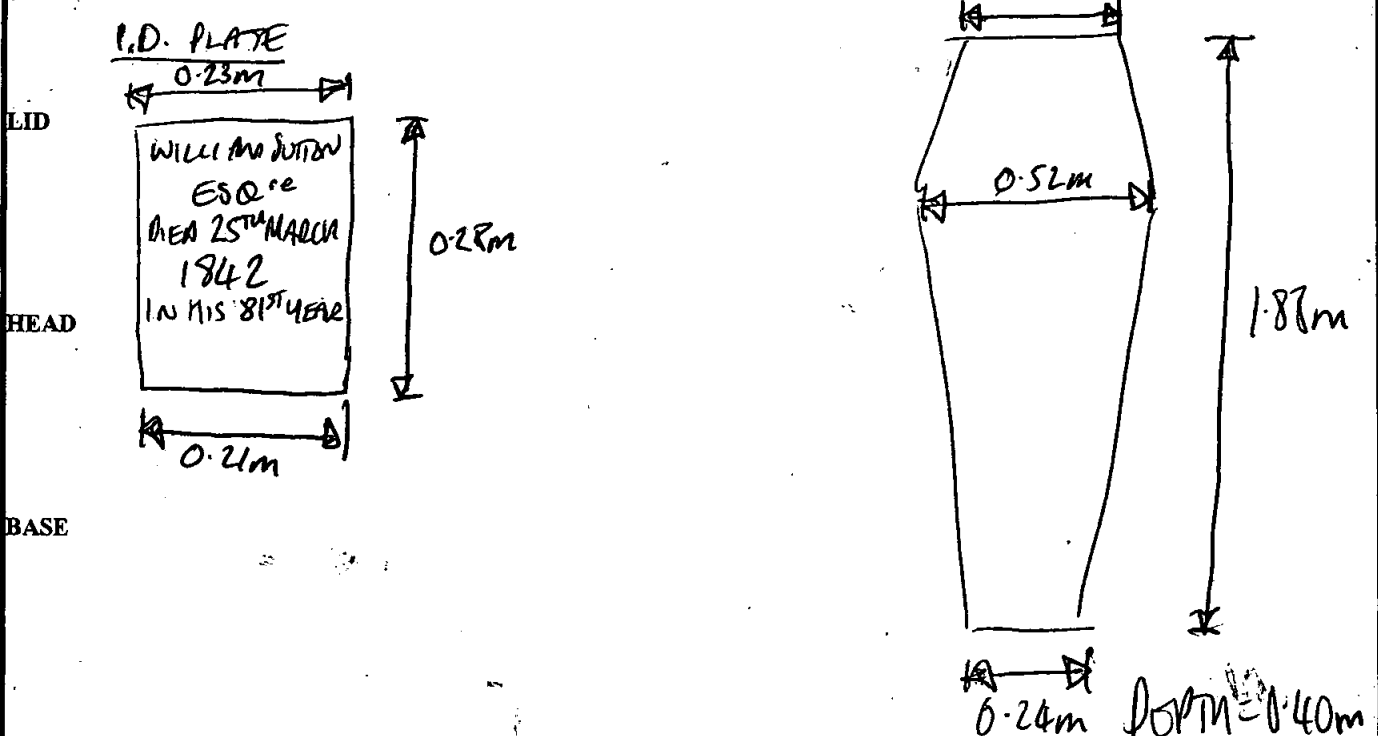

Recorder: *JP* Date: 18/10/00 Initials:

db

SITE 01200	COFFIN RECORD SHEET	CONTEXT NO. 717
Trench:	Additional sheets: YES x 1	Treatment: NECROTICUS
Site sub-div: CRUPT, BAY 3 VAULT 18	Grave fills	
Plan no: 7	Grave cut:	Finds None
Section no:	Skeleton:	Breastplate Grip
Co-ordinates:	Matrix location: 716 717	Hinge Bracket
Levels	Preservation: GOOD.	Fixing nails Shroud pins
Slide No.	Neg No:	Fabric Other finds

Description E-W ADULT BURIAL. PD LINED COFFIN, SERRATED TOP & BTE.

Discussion

Shape, dimensions and distinguishing characteristics

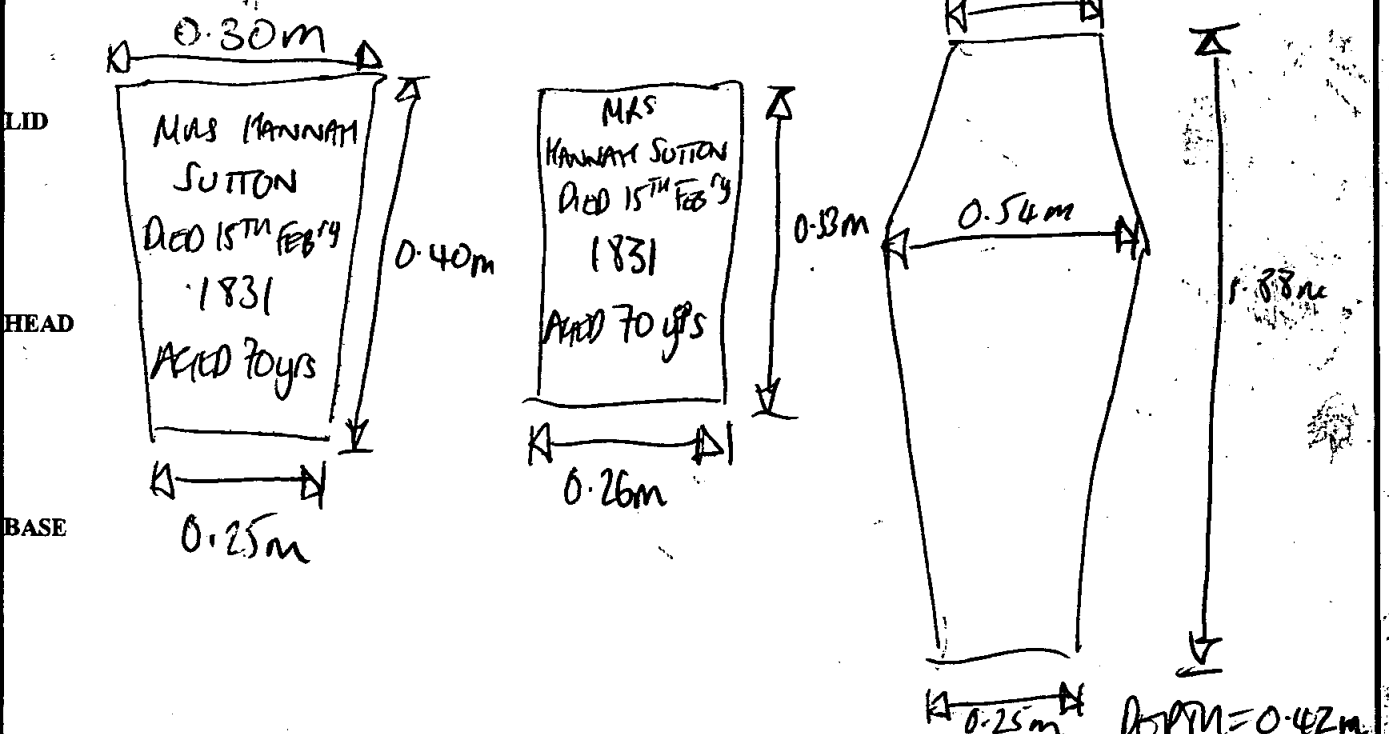

Recorder: [Signature] Date: 18/10/00 Initials:

# Coffin Recording Sheet

**Outer Coffin**

Sample Ret.

Site Code

Context

Recording Date ..... 19/10 .....

OLROO

717

Associated Numbers .....

Condition ..... 3 .....

Dep. Plate

Legible

Inscription "Mrs Hannah Sutton / Died 15th Feb<sup>ry</sup> / 1831 / Aged 70 Yrs"

Fabric lead  iron  ormolou  silvered tin  brass  enamelled  tin plated pewter  other ..... gilt tin  Sample Ret.

**Shape of dep. plate**

square  cartouche  rectangle  oval  shield  other ..... tapered  lozenge

*same as 626.  
(2) (top) w/ inner border 618  
w/ outer border 53A.*

**Upholstery**

colour ..... shoddy  velvet  other ..... Sample Ret.

**Construction**

butt joint  mitred  pitched  other .....

**Grip plate**

Fabric = ormolou  iron  silvered tin  brass  enamelled  tin plated pewter  other ..... gilt tin  Sample Ret.

**Grip**

Fabric = ormolou  brass  iron  Sample Ret.

**Design**

swag of rose  horseshoe  cherub's head  plain

other .....

**Grip bolts**

Corner bolts  Type = gilt brass  brass  iron

other ..... Sample Ret.

**Lid motifs**

other .....

Sample Ret.

**Escutcheons**

other .....

Sample Ret.

**Upholstery nails**

brass  gilt brass  silvered brass  iron  enamelled

other ..... Sample Ret.

**Fixings**

panel nails  screws  hinges  lace  Sample Ret.

**Timber type** .....

Sample Ret.

**Interpretation / Comments**

.....  
.....

cb

SITE <b>DL200</b>	COFFIN RECORD SHEET	CONTEXT NO. <b>718</b>
Trench:	Additional sheets:	Treatment: <b>Bones/DNA <sup>NOT</sup> COLLECTED</b>
Site sub-div: <b>OSPT, BAY 3</b>	Grave fills	
Plan no: <b>7</b>	Grave cut:	Finds None
Section no:	Skeleton:	Breastplate Grip
Co-ordinates:	Matrix location:	Hinge Bracket
Levels	Preservation: <b>AVERAGE/POOR - COFFIN NO. REMS. OF SKELETON.</b>	Fixing nails Shroud pins
Slide No.	Neg No:	Fabric Other finds

**Description** N-E S INFANT BURIAL. PO LIND COFFIN, SOLDERED JOINTS  
BASE. SOLDERED I.P. PLATE AT BREAST OF COFFIN. SKELETON NOT PRESERVED,  
V. POOR PRESERVATION - SOME SIGN OF HAIR.

**Discussion**

**Shape, dimensions and distinguishing characteristics**

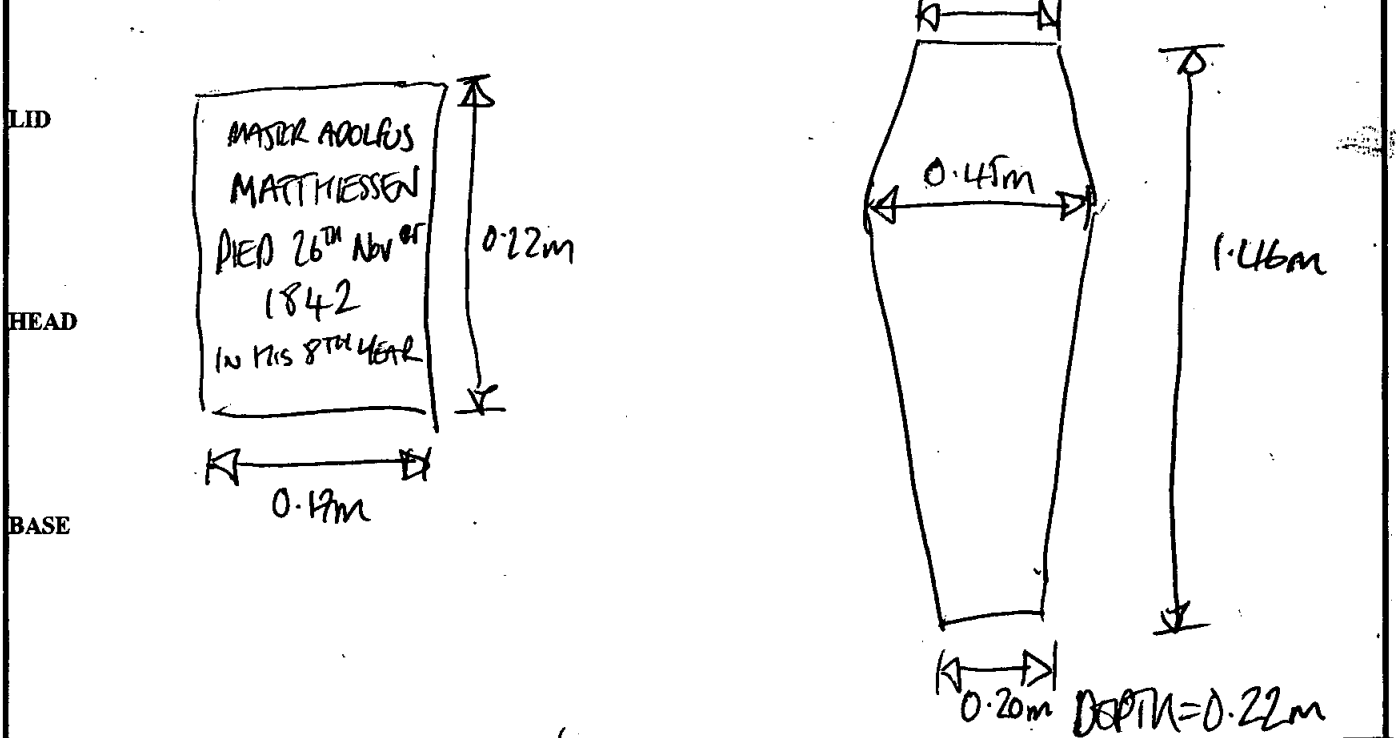

Recorder: <b>AM</b>	Date: <b>18/10/00</b>	Initials:
---------------------	-----------------------	-----------

dlb

SITE	COFFIN RECORD SHEET	CONTEXT NO.
OLR 00		719
Trench:	Additional sheets: YES x 1	Treatment: BONE/DNA COLLECTED.
Site sub-div: CKUM, BM 2	Grave fills	
Plan no: 7	Grave cut:	Finds: None
Section no:	Skeleton:	Breastplate <input checked="" type="checkbox"/> Grip
Co-ordinates:	Matrix location:	Hinge Bracket
Levels	Preservation: GOOD.	Fixing nails Shroud pins
Slide No.	Neg No:	Fabric Other finds:

**Description** W D E ADULT BURIAL. Pb COFFIN. SOLID-ROD TOP & BASE. BREASTPLATE AND COFFIN I.D. PRESENT. COFFIN I.D. SOLID-ROD TO COFFIN TOP. MARK REMS. APPEAR TO BE TIED IN A BUN AT REAR OF HEAD.

**Discussion**

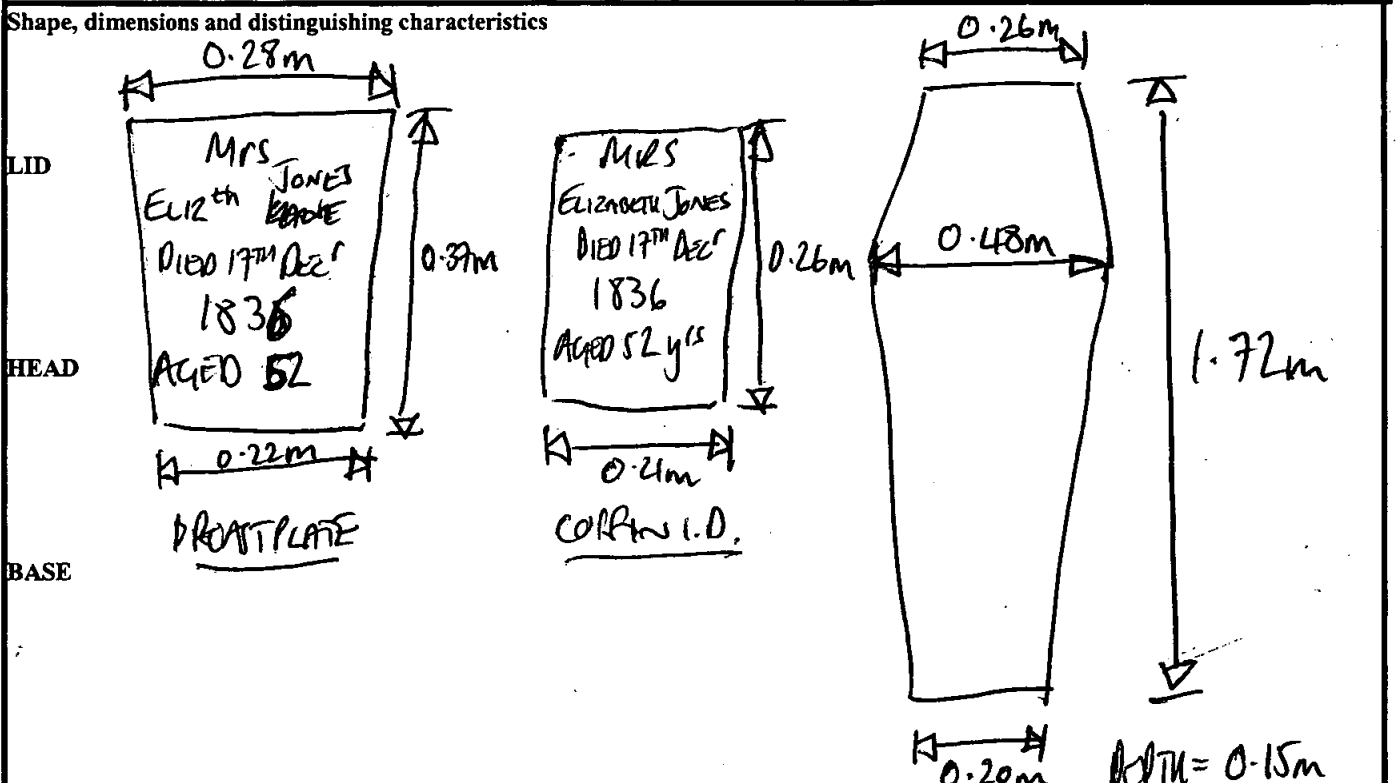

Recorder: \_\_\_\_\_ Date: \_\_\_\_\_ Initials: \_\_\_\_\_

Site Code

Context

OH200

719

Outer Coffin

Sample Ret.

Recording Date ..... 24/10 .....

Associated Numbers .....

Condition .....

Dep. Plate

Legible

Inscription "Mrs/Eliza<sup>m</sup> Jones/Died 17<sup>th</sup> Dec<sup>r</sup>/1836/Aged 52.

Fabric lead  ormolou  brass  tin plated pewter  gilt tin   
 iron  silvered tin  enamelled  other ..... Sample Ret.

Shape of dep. plate

square  rectangle  shield  tapered  lozenge   
 cartouche  oval  other ..... *black polished same as 776*

Upholstery

colour ..... shoddy  velvet  other ..... Sample Ret.

Construction

butt joint  mitred  pitched  other .....

Grip plate

Fabric = ormolou  brass  tin plated pewter  gilt tin   
 iron  silvered tin  enamelled  other ..... Sample Ret.

Grip

Fabric = ormolou  brass  iron  Sample Ret.

Design

swag of rose  horseshoe  cherub's head  plain

other .....

Grip bolts

Corner bolts  Type = gilt brass  brass  iron

other ..... Sample Ret.

Lid motifs

other ..... Sample Ret.

Escutcheons

other ..... Sample Ret.

Upholstery nails

brass  gilt brass  silvered brass  iron  enamelled

other ..... Sample Ret.

Fixings

panel nails  screws  hinges  lace  Sample Ret.

Timber type .....

Sample Ret.

Interpretation / Comments

.....  
 .....



db

SITE <i>QR 00</i>	COFFIN RECORD SHEET	CONTEXT NO. <i>720</i>
Trench:	Additional sheets: <i>YES x 1</i>	Treatment: <i>NEUTRALOUS</i>
Site sub-div: <i>CULT BAR 2</i>	Grave fills	
Plan no: <i>7</i>	Grave cut:	Finds None
Section no:	Skeleton:	Breastplate Grip <input checked="" type="checkbox"/>
Co-ordinates:	Matrix location: <i>(720)</i>	Hinge Bracket
Levels	Preservation: <i>GOOD</i>	Fixing nails Shroud pins
Slide No.	Neg No:	Fabric Other finds

Description *E-W ADULT BURIAL - SOLDERED TOP & BASE LEAD-LINED COFFIN, 'DIAMOND' SHAPED COFFIN I.D. RATE SOLDERED TO BREAST OF COFFIN. SOME TRACES OF WOOD AROUND COFFIN.*

Discussion

Shape, dimensions and distinguishing characteristics

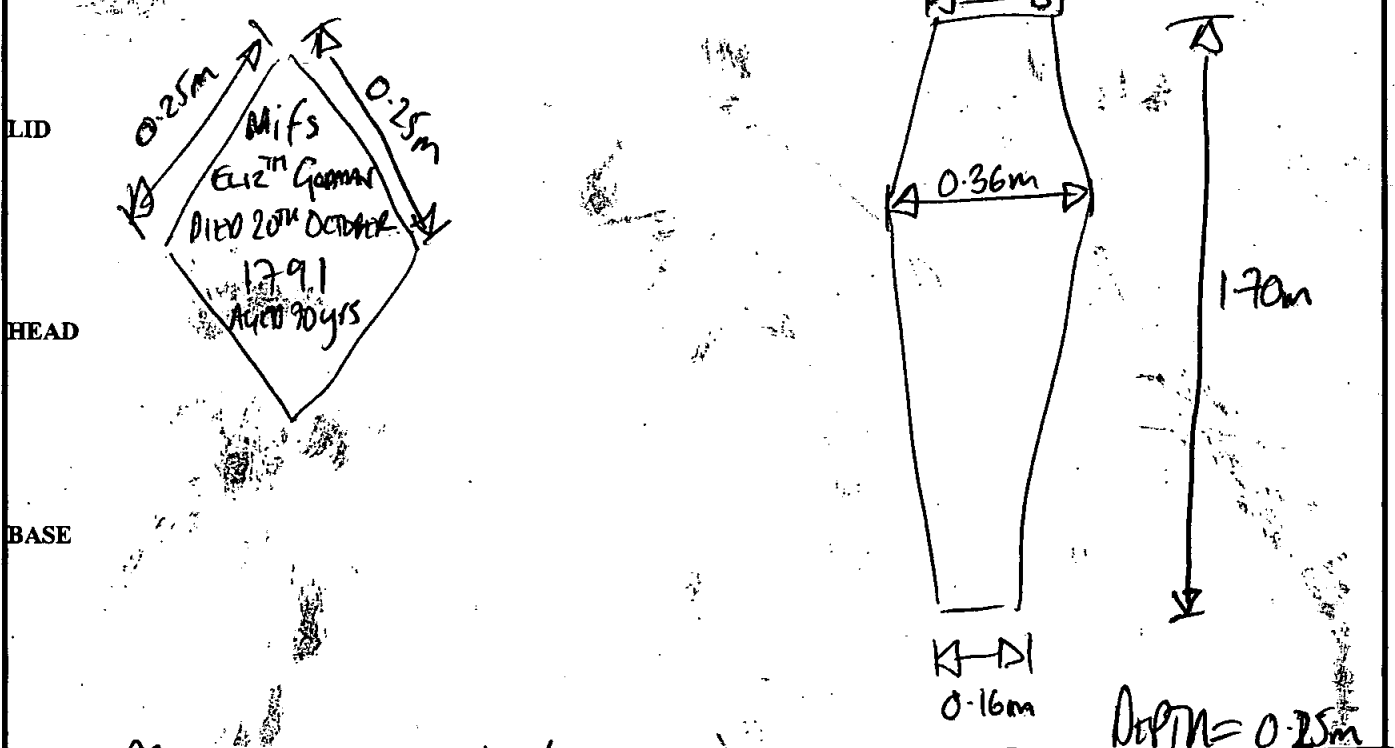

Recorder: <i>AM</i>	Date: <i>17/10/00</i>	Initials:
---------------------	-----------------------	-----------

# Coffin Recording Sheet

Site Code

Context

**Outer Coffin**

Sample Ret.

02R00

720

Recording Date ..... 19/10 .....

Associated Numbers .....

Condition .....

Dep. Plate

Legible

Inscription

Fabric lead  ormolou  brass  tin plated pewter  gilt tin   
 iron  silvered tin  enamelled  other ..... Sample Ret.

**Shape of dep. plate**

square  rectangle  shield  tapered  lozenge   
 cartouche  oval  other .....

**Upholstery**

colour ..... shoddy  velvet  other ..... Sample Ret.

**Construction**

butt joint  mitred  pitched  other .....

Grip plate  Fabric = ormolou  brass  tin plated pewter  gilt tin   
 iron  silvered tin  enamelled  other ..... Sample Ret.

Grip  Fabric = ormolou  brass  iron  <sup>x1</sup> 1 Sample Ret.

Design swag of rose  horseshoe  cherub's head  plain   
 other .....

Grip bolts  Corner bolts  Type = gilt brass  brass  iron   
 other ..... Sample Ret.

Lid motifs  other ..... Sample Ret.

Escutcheons  other ..... Sample Ret.

Upholstery nails  brass  gilt brass  silvered brass  iron  enamelled   
 other ..... Sample Ret.

Fixings  panel nails  screws  hinges  lace  Sample Ret.

Timber type ..... Sample Ret.

**Interpretation / Comments**

.....  
 .....

db

SITE	COFFIN RECORD SHEET	CONTEXT NO.
OLR00		721
Trench:	Additional sheets: <u>YES x1.</u>	Treatment:
Site sub-div: <u>CUMT BAY 2</u>	Grave fills	<u>Neurotoxis</u>
Plan no: <u>7</u>	Grave cut:	Finds None
Section no:	Skeleton:	Breastplate <input checked="" type="checkbox"/> Grip
Co-ordinates:	Matrix location: <u>(721)</u>	Hinge Bracket
Levels	Preservation: <u>GOOD</u>	Fixing nails Shroud pins
Slide No.	Neg No:	Fabric Other finds

Description W-E ADULT BURIAL. No LINED COFFIN SOUNDED BY X-RAYS  
EMBOSSED COFFIN I.D. AND BREASTPLATE PRESENT. SOME TRACES OF WOOD REMAIN  
COFFIN. SIDE PLATE LOCATED AT ASTRIS - <sup>are</sup> SOUNDED TO WOOD BY PINS.

Discussion

Shape, dimensions and distinguishing characteristics

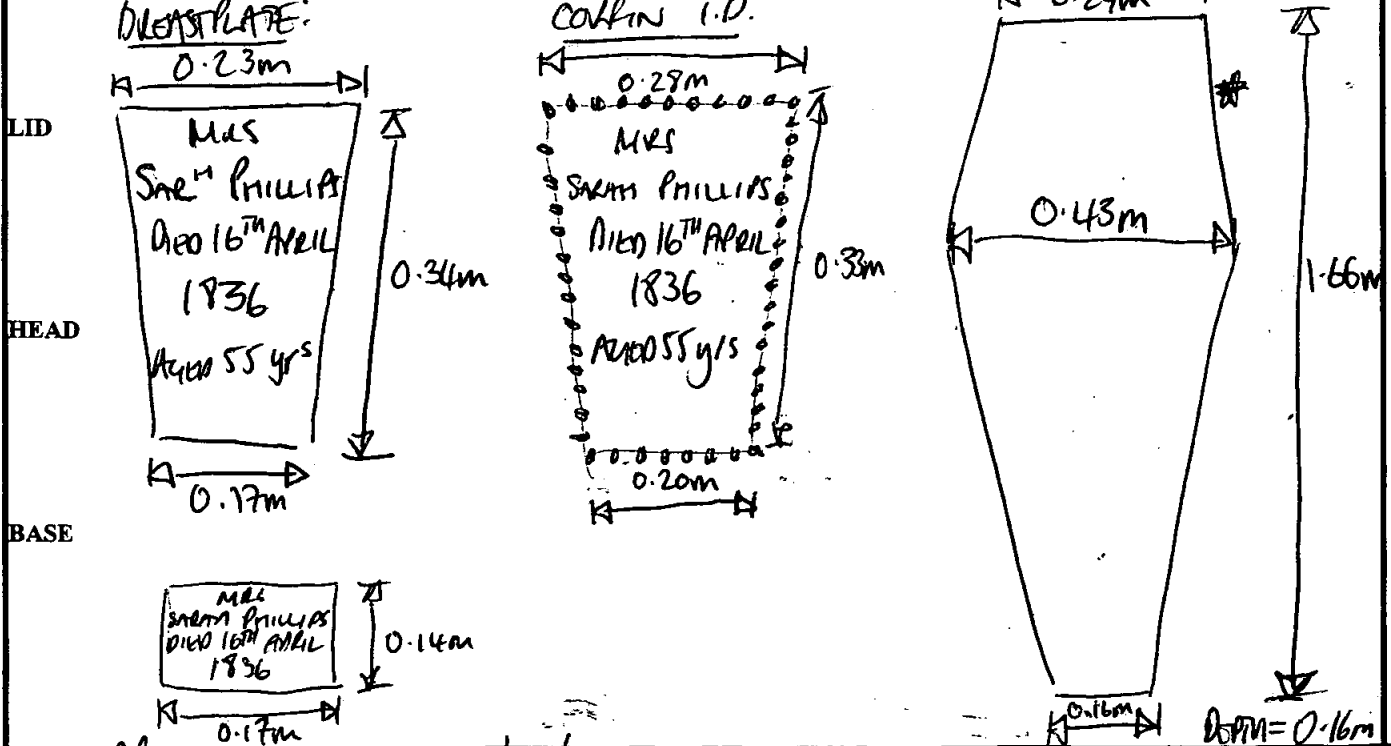

Recorder: DM Date: 19/10/00 Initials:

Site Code

Context

OR05

721

**Outer Coffin**

Sample Ret.

Recording Date ..... 19/10 .....

Associated Numbers .....

Condition .....

Dep. Plate

Legible

Inscription

"Mrs / Sar<sup>h</sup> Phillips / Died 10<sup>th</sup> April / 1836 / Aged 55 Yrs"

Fabric lead  ormolou  brass  tin plated pewter  gilt tin   
 iron  silvered tin  enamelled  other ..... Sample Ret.

Black polished. (21) w/out outer border.

**Shape of dep. plate**

square  rectangle  shield  tapered  lozenge   
 cartouche  oval  other .....

**Upholstery**

colour ..... shoddy  velvet  other ..... Sample Ret.

**Construction**

butt joint  mitred  pitched  other .....

**Grip plate**

Fabric = ormolou  brass  tin plated pewter  gilt tin   
 iron  silvered tin  enamelled  other ..... Sample Ret.

Frog of cartouche.

**Grip**

Fabric = ormolou  brass  iron  Sample Ret.

x3  
(6)'s

**Design**

swag of rose  horseshoe  cherub's head  plain

other .....

**Grip bolts**

Corner bolts  Type = gilt brass  brass  iron

other ..... Sample Ret.

**Lid motifs**

other ..... Sample Ret.

**Escutcheons**

other ..... Sample Ret.

**Upholstery nails**

brass  gilt brass  silvered brass  iron  enamelled

other ..... Sample Ret.

**Fixings**

panel nails  screws  hinges  lace  Sample Ret.

**Timber type**

..... Sample Ret.

**Interpretation / Comments**

.....  
 .....

db

SITE OL 200		COFFIN RECORD SHEET	CONTEXT NO. 722
Trench:	Additional sheets: YES x 1.	Treatment: BONE/DNA CONSERVED	
Site sub-div: OL 11 6M 2	Grave fills		
Plan no: 7	Grave cut:	Finds: None	
Section no:	Skeleton: GOOD.	Breastplate ✓	
Co-ordinates:	Matrix location: 722	Grip	
Levels	Preservation: AVERAGE	Hinge	
Slide No.	Neg No:	Bracket	
		Fixing nails	
		Shroud pins	
		Fabric	
		Other finds:	

**Description** WE EARTH ADULT BURIAL. PD COFFIN SCANNED TOP & BASE. ONUSWAZ 'CROSS-MATCHING' OVER ENTIRE COFFIN LEAD. SOME TRACES OF WOOD AROUND COFFIN. SUGGEST TRACES OF SAND-TOAST WITHIN COFFIN.

**Discussion**

**Shape, dimensions and distinguishing characteristics**

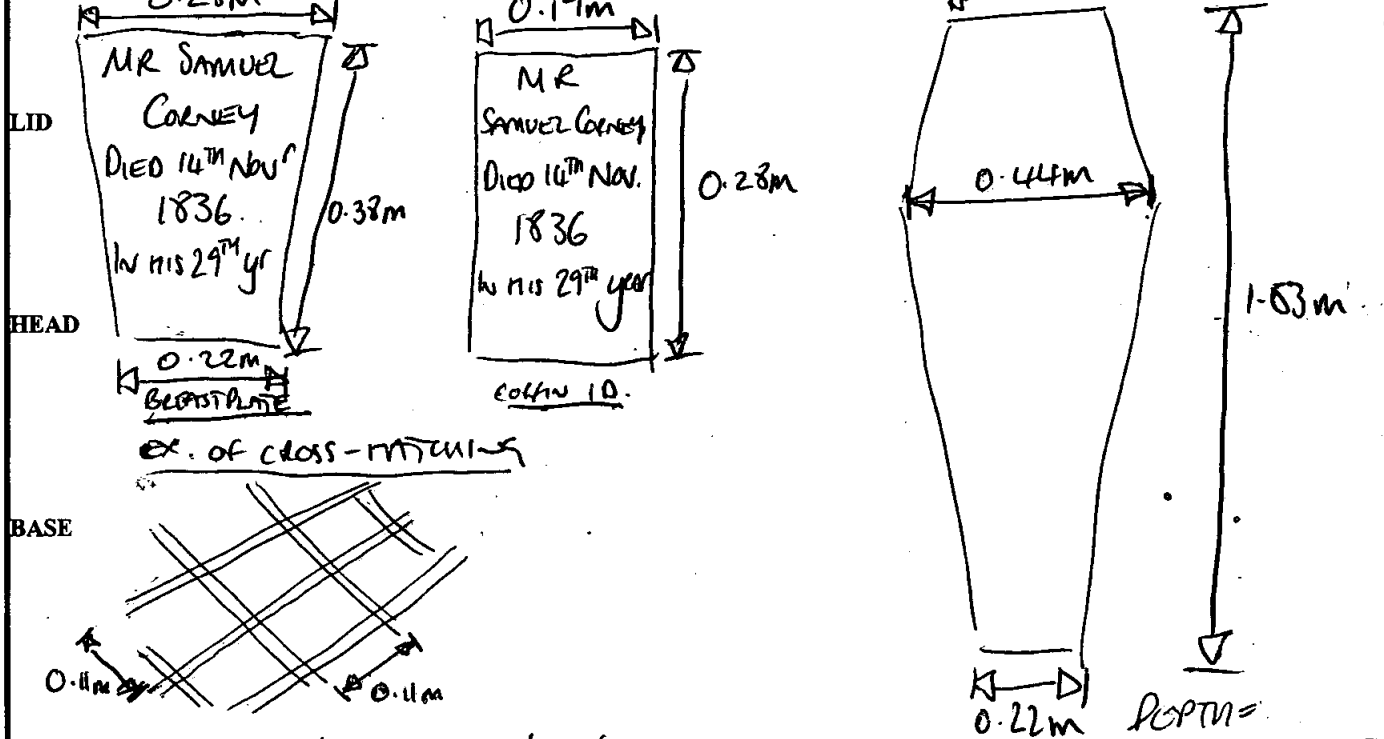

Recorder: <i>AM</i>	Date: 19/10/00	Initials:
---------------------	----------------	-----------

# Coffin Recording Sheet

Site Code

Context

Ohloo

722

**Outer Coffin**

Sample Ret.

Recording Date ..... 24/10.

Associated Numbers .....

Condition ..... 3

Dep. Plate

Legible

Inscription "Mr Samuel Cooney / Died 14<sup>th</sup> Nov / 1836 / In his 29<sup>th</sup> yr"

**Fabric lead**  ormolou  brass  tin plated pewter  gilt tin   
 iron  silvered tin  enamelled  other ..... Sample Ret.   
*black polished*

**Shape of dep. plate**  
 square  rectangle  shield  tapered  lozenge   
 cartouche  oval  other ..... *same as 776*

**Upholstery**   
 colour ..... shoddy  velvet  other ..... Sample Ret.

**Construction** butt joint  mitred  pitched  other .....

**Grip plate**  **Fabric =** ormolou  brass  tin plated pewter  gilt tin   
 iron  silvered tin  enamelled  other ..... Sample Ret.

**Grip**  **Fabric =** ormolou  brass  iron  Sample Ret.

**Design** swag of rose  horseshoe  cherub's head  plain   
 other .....

**Grip bolts**  **Corner bolts**  **Type =** gilt brass  brass  iron   
 other ..... Sample Ret.

**Lid motifs**  other ..... Sample Ret.

**Escutcheons**  other ..... Sample Ret.

**Upholstery nails**  brass  gilt brass  silvered brass  iron  enamelled   
 other ..... Sample Ret.

**Fixings**  panel nails  screws  hinges  lace  Sample Ret.

**Timber type** ..... Sample Ret.

**Interpretation / Comments**  
 .....  
 .....

db

SITE <u>OLROO</u>		COFFIN RECORD SHEET	CONTEXT NO. <u>723</u>
Trench:	Additional sheets:	Treatment:	<u>NOT COLLECTED</u>
Site sub-div: <u>Grp 1, BMS</u>	Grave fills:	Findings:	None
Plan no: <u>7</u>	Grave cut:	Breastplate:	Grip
Section no:	Skeleton: <u>bone pres. poor</u>	Hinge:	Bracket
Co-ordinates:	Matrix location: <u>(723)</u>	Fixing nails:	Shroud pins
Levels:	Preservation: <u>poor</u>	Fabric:	Other finds:
Slide No.:	Neg No.:		

**Description**  
~~adult~~ S-N ADULT BURIAL. PD LINED COFFIN SOLIDIFIED TOP & SIDE. NO SIGNS OF WOOD AROUND COFFIN. SOLIDIFIED I.P. PLATE ON BREAST OF COFFIN. BONE WITHIN COFFIN, THUS BONE PRES. POOR

**Discussion**

**Shape, dimensions and distinguishing characteristics**

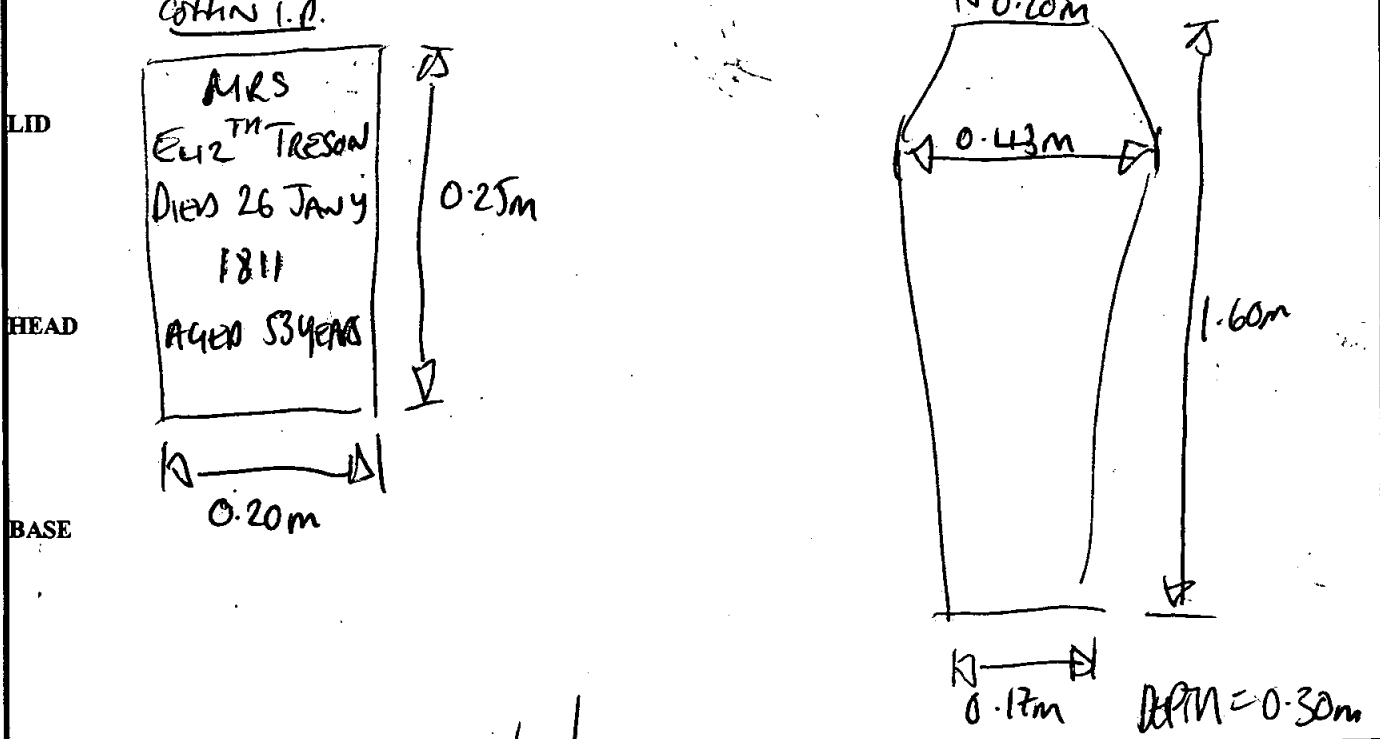

Recorder: <u>[Signature]</u>	Date: <u>19/10/00</u>	Initials:
------------------------------	-----------------------	-----------

db

SITE	COFFIN RECORD SHEET	CONTEXT NO.
OLR00		724
Trench:	Additional sheets:	Treatment:
Site sub-div: CULPT, RM3	Grave fills	BONE/INA COVERED
Plan no: 7	Grave cut:	Finds None
Section no:	Skeleton: good	Breastplate Grip
Co-ordinates:	Matrix location: 724	Hinge Bracket
Levels	Preservation: poor	Fixing nails Shroud pins
Slide No.	Neg No:	Fabric Other finds

**Description** N → S ADULT BURIAL. Pb coffin, soldered top & base, NO SIGN OF OUTER WOOD SURROUND. EMBOSSED I.O. ON BREAST OF COFFIN BRASS TRACES WITHIN COFFIN.

**Discussion**

**Shape, dimensions and distinguishing characteristics**

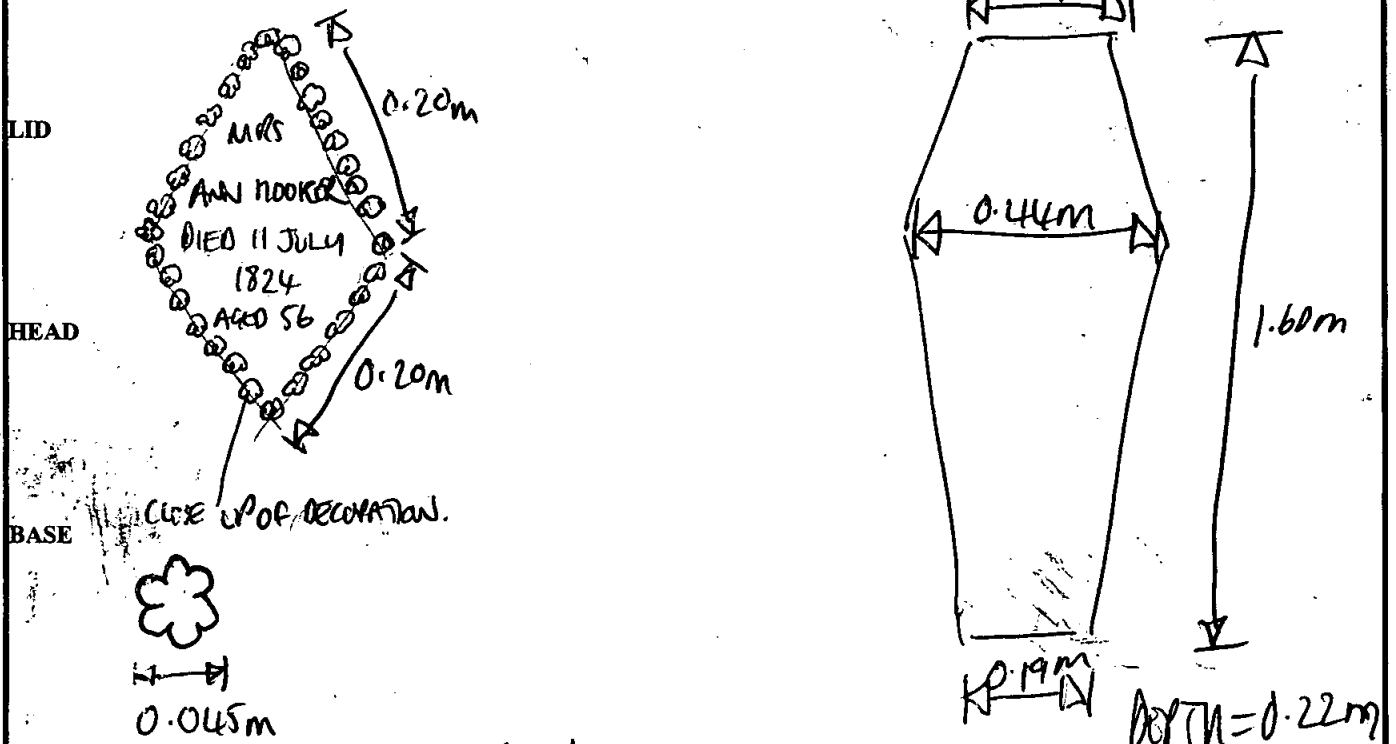

Recorder: *DM* Date: 19/10/00 Initials:



db

SITE		COFFIN RECORD SHEET		CONTEXT NO. 725	
Trench:	Additional sheets: YES XI.	Treatment:			
Site sub-div: CUMPT, BAUL VAULT 240	Grave fills	→ Necropolis			
Plan no: 7	Grave cut:	Finds			
Section no:	Skeleton:	None			
Co-ordinates:	Matrix location: 725 726 727 728	Breastplate			
Levels	Preservation: GOOD	Grip			
Slide No.	Neg No:	Hinge			
		Bracket			
		Fixing nails			
		Shroud pins			
		Fabric			
		Other finds			

Description N-S INFANT BURIAL. Pb COFFIN SOLIDIFIED TOP & BOTTOM. BREASTPLATE, SOLIDIFIED I.D. PLATE ON BREAST OF Pb COFFIN, AND HEAD PLATE AT ANCHORS. HEAD PLATE NAILED TO OUTER WOOD. COFFIN OUTER WOOD PRESENT.

Discussion

Shape, dimensions and distinguishing characteristics

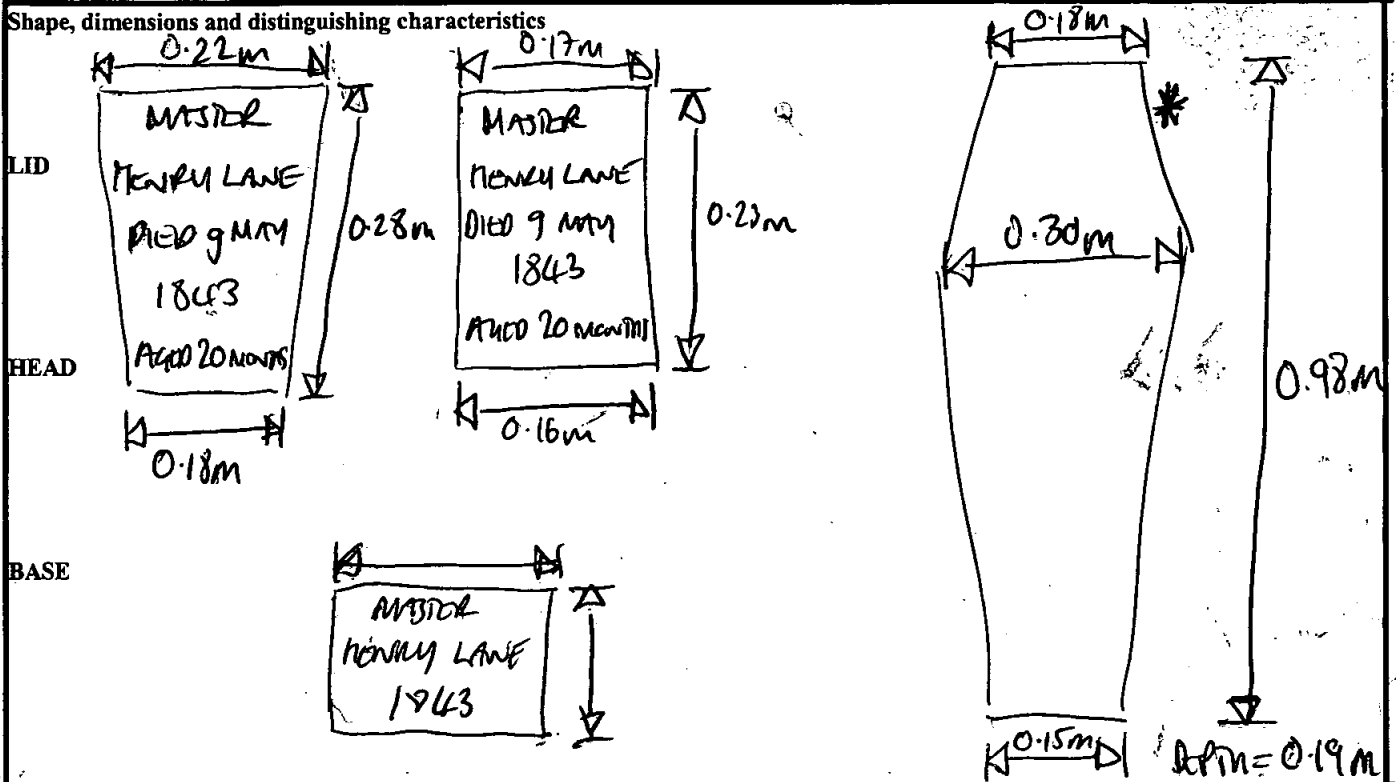

Recorder: *AWM* Date: 19 | 10 | 00 Initials:

Site Code

Context

Outer Coffin

Sample Ret.

OLR00

725

Recording Date ..... 20/19 .....

Associated Numbers .....

Condition ..... 2 .....

Dep. Plate

Legible

Inscription "Master/Henry Lane/Died 9<sup>th</sup> May/1843/Aged 20 Months"

Fabric lead  ormolou  brass  tin plated pewter  gilt tin   
 iron  silvered tin  enamelled  other ..... Sample Ret.

Shape of dep. plate

square  rectangle  shield  tapered  lozenge   
 cartouche  oval  other ..... *same as 762, w/ diff border & smaller (0.22x0.18x0.27) - infant*

Upholstery

colour ..... shoddy  velvet  other ..... Sample Ret.

Construction

butt joint  mitred  pitched  other .....

Grip plate  Fabric = ormolou  brass  tin plated pewter  gilt tin   
 iron  silvered tin  enamelled  other ..... Sample Ret.

Grip  Fabric = ormolou  brass  iron  Sample Ret.

Design swag of rose  horseshoe  cherub's head  plain   
 other .....

Grip bolts  Corner bolts  Type = gilt brass  brass  iron   
 other ..... Sample Ret.

Lid motifs  other ..... Sample Ret.

Escutcheons  other ..... Sample Ret.

Upholstery nails  brass  gilt brass  silvered brass  iron  enamelled   
 other ..... Sample Ret.

Fixings  panel nails  screws  hinges  lace  Sample Ret.

Timber type ..... Sample Ret.

Interpretation / Comments

.....  
 .....

db

SITE OLR00	COFFIN RECORD SHEET	CONTEXT NO. 726
Trench:	Additional sheets:	Treatment:
Site sub-div: CUMPT, 6M1 VAULT 240	Grave fills	- NUCULOPOLIS
Plan no:	Grave cut:	Finds None
Section no:	Skeleton:	Breastplate Grip
Co-ordinates:	Matrix location: 725 726 727 728 729 730 731 732	Hinge Bracket
Levels	Preservation: 900V	Fixing nails Shroud pins
Slide No.	Neg No:	Fabric Other finds

Description N-S INFANT BURIAL, PD COFFIN SEATED TOP & BRISTLE WOOD SURROUND PRESENT. EMBOSSED I.D. PLATE ON BREAST OF COFFIN. (MASTER JOHN EVANS [E] LANE, 0120 11-09-1830, Aged 5 YEARS) CROSSMATCHING PRESENT ON COFFIN TOP

Discussion

Shape, dimensions and distinguishing characteristics

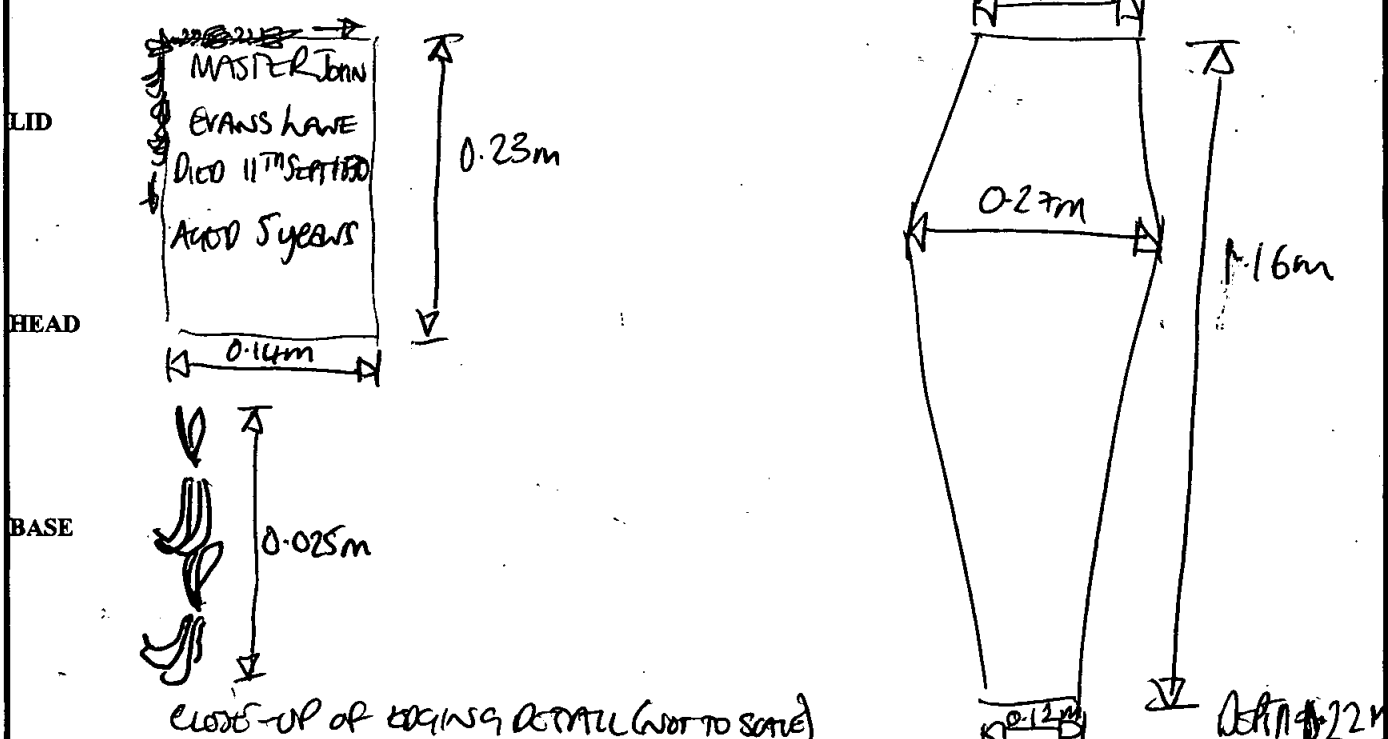

Recorder: \_\_\_\_\_ Date: \_\_\_\_\_ Initials: \_\_\_\_\_

db

SITE	COFFIN RECORD SHEET	CONTEXT NO.
OLROO		727
Trench:	Additional sheets: YES x 2.	Treatment:
Site sub-div: CULV1, CULV2 VAULT 240	Grave fills	NECROBURS
Plan no:	Grave cut:	Findings
		None
Section no:	Skeleton:	Breastplate
		Grip ✓
Co-ordinates:	Matrix location: 725 726 727 728	Hinge
	729 762 763 764	Bracket
Levels	Preservation:	Fixing nails
		Shroud pins
Slide No.	Neg No:	Fabric
		Other finds:

**Description** N-S INFANT BURIAL. Pb COFFIN SOLDERED TOP & BASE. SIGNS OF WOOD COFFIN. BREASTPLATE, COFFIN I.D. PLATE SOLDERED TO BRATT OF COFFIN. HEAD PLATE NAILED TO CURVE WOOD AT SHOULDERS. WELL CONSTRUCTED COFFIN - NOT BREACHED AT ALL - ALL SOLDER ARE WIDE (0.05m) AND THICK LEAD (0.03m - 0.04m) USED.

Shape, dimensions and distinguishing characteristics

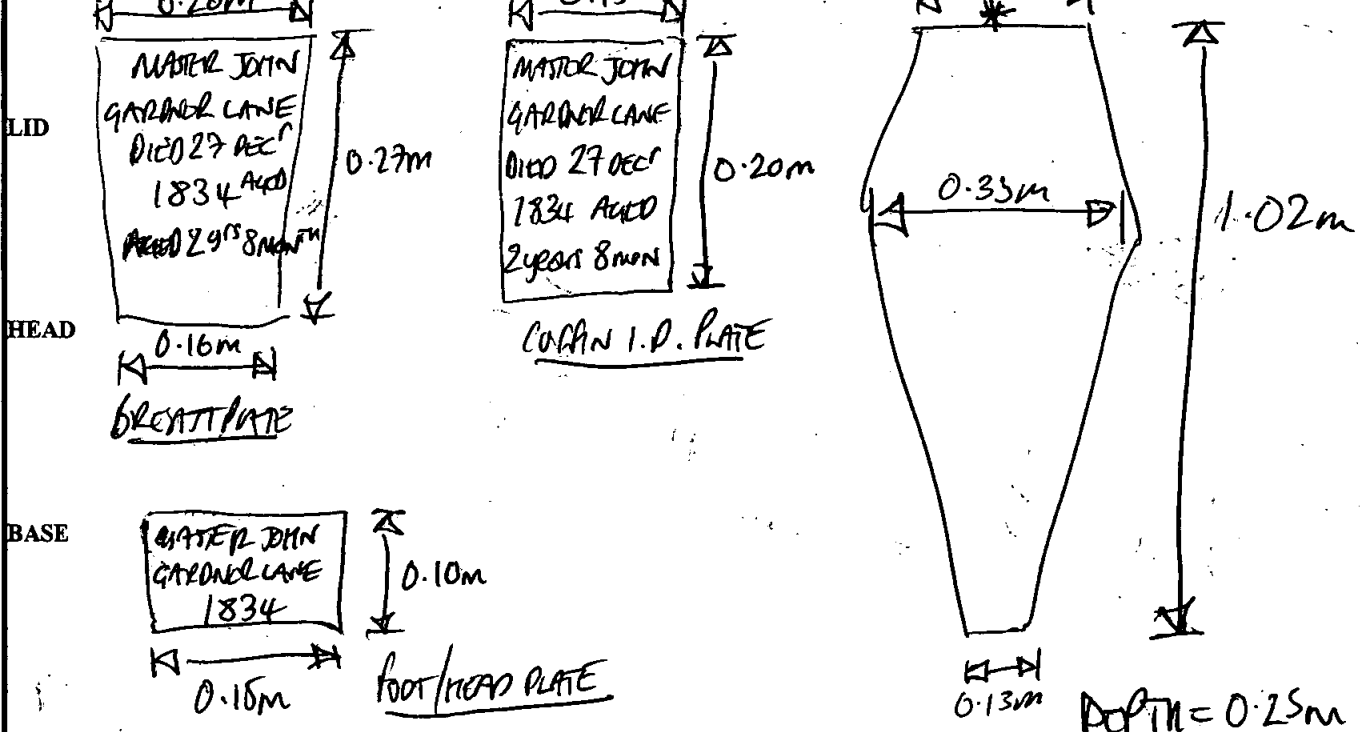

Recorder: [Signature] Date: 19/10/00 Initials:

Site Code

Context

02R00

727

**Outer Coffin**

Sample Ret.

Recording Date ..... 20/10 .....

Associated Numbers .....

Condition

3

Dep. Plate

Legible

Inscription

"Master John / Gardner Lane / Died 27<sup>th</sup> Dec<sup>r</sup> / 1834 Aged / 2 Years 9 Mon: /"

Fabric lead  ormolou  brass  tin plated pewter  gilt tin   
 iron  silvered tin  enamelled  other ..... Sample Ret.

**Shape of dep. plate**

square  rectangle  shield  tapered  lozenge   
 cartouche  oval  other .....

**Upholstery**

colour ..... shoddy  velvet  other ..... Sample Ret.

**Construction**

butt joint  mitred  pitched  other .....

**Grip plate**

Fabric = ormolou   
 frogs on rev. of grip

iron  silvered tin  brass  tin plated pewter  gilt tin   
 enamelled  other ..... Sample Ret.

**Grip**

Fabric = ormolou

brass

iron  x 1 Sample Ret.   
 infant grip ← = 0.09  
 ↓ = 0.04 plain

**Design**

swag of rose  horseshoe  cherub's head  plain

other .....

**Grip bolts**

**Corner bolts**

Type = gilt brass

brass

iron

other ..... Sample Ret.

**Lid motifs**

other ..... Sample Ret.

**Escutcheons**

other ..... Sample Ret.

**Upholstery nails**

brass  gilt brass  silvered brass  iron  enamelled

other ..... Sample Ret.

**Fixings**

panel nails  screws  hinges  lace  Sample Ret.

**Timber type** .....

Sample Ret.

**Interpretation / Comments**

.....  
 .....

db

SITE <b>OLR 00</b>	COFFIN RECORD SHEET	CONTEXT NO. <b>726</b>
Trench:	Additional sheets:	Treatment:
Site sub-div: <b>CRYPT, BAY 1 VAULT 240</b>	Grave fills	<b>NECROPOLIS</b>
Plan no: <b>7</b>	Grave cut:	Finds
Section no:	Skeleton:	None
Co-ordinates:	Matrix location: <b>725 726 727 728</b> <b>762 763 764</b>	Breastplate
Levels	Preservation:	Grip
Slide No.	Neg No:	Hinge
		Bracket
		Fixing nails
		Shroud pins
		Fabric
		Other finds

Description **N-S INFANT BURIAL. NAILED TOP & BASE Pb COFFIN, NO EVIDENCE OF WOOD OUTER COFFIN. NO NAME-PLATE**

Discussion

Shape, dimensions and distinguishing characteristics

LID

HEAD

BASE

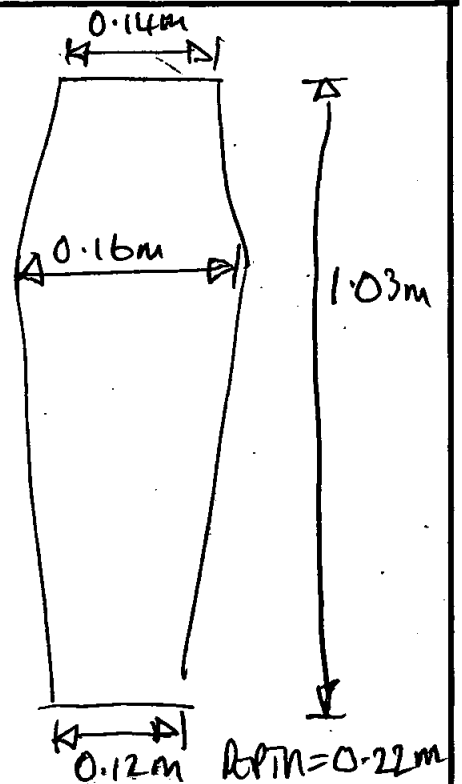

Recorder: <b>DM</b>	Date: <b>19/10/00</b>	Initials:
---------------------	-----------------------	-----------

SITE <u>OR 00</u>		COFFIN RECORD SHEET	CONTEXT NO. <u>729</u>
Trench:	Additional sheets:	Treatment: <u>B.C.</u>	
Site sub-div: <u>NC</u>	Grave fills: <u>/</u>		
Plan no: <u>3</u>	Grave cut: <u>/</u>	Finds	
Section no:	Skeleton: <u>729</u>	None	
Co-ordinates:	Matrix location: <u>695 WITH 729 1299e 1300</u>	Breastplate	
Levels	Preservation: <u>Good/Poor.</u>	Grip	
Slide No.	Neg No:	Hinge	
Description		Bracket	
<p><u>E-W child burial, associated with 695, <del>no</del> <u>729</u> is the <u>bigger baby</u> possibly mixed with channel.</u></p>		Fixing nails	
Discussion		Shroud pins	
Shape, dimensions and distinguishing characteristics		Fabric	
LID		Other finds	
HEAD			
BASE			
Recorder: <u>JHM</u>	Date: <u>18.10.00</u>	Initials:	

SITE <i>OR 00</i>	COFFIN RECORD SHEET	CONTEXT NO. <i>730</i>
Trench:	Additional sheets:	Treatment: <i>B.C.</i>
Site sub-div: <i>NC</i>	Grave fills <i>/</i>	
Plan no: <i>3</i>	Grave cut: <i>/</i>	Finds None
Section no:	Skeleton: <i>730</i>	Breastplate Grip
Co-ordinates:	Matrix location: <i>730</i>	Hinge Bracket
Levels	Preservation: <i>FAIR.</i>	Fixing nails Shroud pins
Slide No.	Neg No:	Fabric Other finds
Description <i>E-W Adult burial - imperfect collection rate due to removal by machine. <del>found</del></i>		
Discussion		
Shape, dimensions and distinguishing characteristics  LID  HEAD  BASE		
Recorder: <i>D. ASM</i>	Date: <i>19.10.50</i>	Initials:



**Outer Coffin**

Sample Ret.

Site Code

Context

OH200

730

Recording Date ..... 22/2/01 .....

Associated Numbers .....

Condition ..... 1 .....

Dep. Plate

Legible  1564

Inscription "M?/ ? on Wills??/ Died 21<sup>st</sup> Mar<sup>n</sup>/1820/Aged 48 years"  
 (3) w new outer border.

Fabric lead  ormolou  brass  tin plated pewter  gilt tin   
 iron  silvered tin  enamelled  other ..... Sample Ret.

*Black polished.*

**Shape of dep. plate**

square  rectangle  shield  tapered  lozenge   
 cartouche  oval  other .....

**Upholstery**

colour ..... shoddy  velvet  other ..... Sample Ret.

**Construction**

butt joint  mitred  pitched  other .....

Grip plate  Fabric = ormolou  brass  tin plated pewter  gilt tin   
 iron  silvered tin  enamelled  other ..... Sample Ret.

Grip  Fabric = ormolou  brass  iron  Sample Ret.

Design swag of rose  horseshoe  cherub's head  plain   
 other .....

Grip bolts  Corner bolts  Type = gilt brass  brass  iron   
 other ..... Sample Ret.

Lid motifs  other ..... Sample Ret.

Escutcheons  other ..... Sample Ret.

Upholstery nails  brass  gilt brass  silvered brass  iron  enamelled   
 other ..... Sample Ret.

Fixings  panel nails  screws  hinges  lace  Sample Ret.

Timber type ..... Sample Ret.

**Interpretation / Comments**

.....  
 .....

db

SITE <i>OLR 00</i>		COFFIN RECORD SHEET	CONTEXT NO. <i>731</i>
Trench:	Additional sheets: <i>YES x1</i>	Treatment: <i>B.C.</i>	
Site sub-div: <i>NC</i>	Grave fills <i>/</i>		
Plan no: <i>3</i>	Grave cut: <i>/</i>	Finds None	
Section no:	Skeleton: <i>731</i>	Breastplate Grip	
Co-ordinates:	Matrix location: <i>695</i> <i>729</i> <i>731</i>	Hinge Bracket	
Levels	Preservation: <i>FAIR</i>	Fixing nails Shroud pins	
Slide No.	Neg No:	Fabric Other finds	
Description <i>E-W Adult burial - disturbed by burial of 729 + 695, mainly all there but not necessarily articulated - heavy disturbance.</i>			
Discussion			
Shape, dimensions and distinguishing characteristics			
LID			
HEAD			
BASE			
Recorder: <i>D. Ham</i>	Date: <i>19.10.00</i>	Initials:	

# Coffin Recording Sheet

**Outer Coffin**

Sample Ret.

Site Code

Context

Recording Date ..... 12/12/00 .....

**OLR00**

**731**

Associated Numbers .....

Condition .....

Dep. Plate

Legible

Inscription

**Fabric** lead  ormolou  brass  tin plated pewter  gilt tin   
 iron  silvered tin  enamelled  other ..... Sample Ret.

**Shape of dep. plate**

square  rectangle  shield  tapered  lozenge   
 cartouche  oval  other .....

**Upholstery**

colour ..... shoddy  velvet  other ..... Sample Ret.

**Construction**

butt joint  mitred  pitched  other .....

**Grip plate**

Fabric = ormolou  brass  tin plated pewter  gilt tin   
 iron  *Fregs in rev of grip-unid.* silvered tin  enamelled  other ..... Sample Ret.

**Grip**

Fabric = ormolou  brass  iron  *x2* Sample Ret.

**Design**

swag of rose  horseshoe  cherub's head  **(2b)** plain

other .....

**Grip bolts**

**Corner bolts**  Type = gilt brass  brass  iron

other ..... Sample Ret.

**Lid motifs**

other ..... Sample Ret.

**Escutcheons**

other ..... Sample Ret.

**Upholstery**

*studs*  brass  gilt brass  silvered brass  iron  enamelled

other ..... *1 x 000000000000 / 12 studs in total - 1 piece* Sample Ret.

**Fixings**

panel nails  screws  hinges  lace  Sample Ret.

**Timber type**

Sample Ret.

**Interpretation / Comments**

.....  
 .....

SITE	COFFIN RECORD SHEET	CONTEXT NO.
OLR 00	Additional sheets: YESX1	732 Treatment: D.C.
Trench:	Grave fills —	
Site sub-div: NC	Grave cut: —	Finds
Plan no: 3	Skeleton: 732	None
Section no:	Matrix location: 732 733	Breastplate
Co-ordinates:	Preservation: Good.	Grip
Levels	Slide No.	Hinge
Slide No.	Neg No:	Bracket
Description	E-W Anat burial.	Fixing nails
Discussion	Shape, dimensions and distinguishing characteristics	Shroud pins
LID		Fabric
HEAD		Other finds
BASE	Recorder: D. HAM	Date: 19.10.00
	Date: 19.10.00	Initials:

Site Code

Context

**Outer Coffin**

Sample Ret.

OLLOO

732

Recording Date ..... 13/2/01 .....

Associated Numbers .....

Condition .....

Dep. Plate

Legible

Inscription

Fabric lead  ormolou  brass  tin plated pewter  gilt tin   
 iron  silvered tin  enamelled  other ..... Sample Ret.

**Shape of dep. plate**

square  rectangle  shield  tapered  lozenge   
 cartouche  oval  other .....

**Upholstery**

colour ..... shoddy  velvet  other ..... Sample Ret.

**Construction**

butt joint  mitred  pitched  other .....

Grip plate  Fabric = ormolou  brass  tin plated pewter  gilt tin   
 iron  silvered tin  enamelled  other ..... Sample Ret.   
*1x 2286 ← 0.135 ↓ widest point 0.055*

Grip  Fabric = ormolou  brass  iron  Sample Ret.   
*2 → 0.135 ↓ 1x 2289 0.035*

Design swag of rose  horseshoe  cherub's head  plain   
 other .....

Grip bolts  Corner bolts  Type = gilt brass  brass  iron

other ..... Sample Ret.

Lid motifs  other ..... Sample Ret.

Escutcheons  other ..... Sample Ret.

Upholstery nails  brass  gilt brass  silvered brass  iron  enamelled

other ..... Sample Ret.

Fixings  panel nails  screws  hinges  lace  Sample Ret.

Timber type ..... Sample Ret.

**Interpretation / Comments**

.....  
 .....

SITE	COFFIN RECORD SHEET	CONTEXT NO.
02R 00		733
Trench:	Additional sheets:	Treatment: B.C.
Site sub-div: NC	Grave fills /	
Plan no: 3	Grave cut: /	Finds
Section no:	Skeleton: 733	None
Co-ordinates:	Matrix location: 732 733 734	Breastplate
Levels	Preservation: Good.	Grip
Slide No.	Neg No:	Hinge
Description	E-W Adult burial, underlying 732.	Bracket
Discussion		Fixing nails
Shape, dimensions and distinguishing characteristics		Shroud pins
LID		Fabric
HEAD		Other finds
BASE		
Recorder: D. H. M.	Date: 19.10.00	Initials:

SITE <i>OLR 00</i>		COFFIN RECORD SHEET		CONTEXT NO. <i>734</i>	
Trench:		Additional sheets:		Treatment:	
Site sub-div: <i>NC</i>		Grave fills <i>/</i>		<i>B.C.</i>	
Plan no: <i>3</i>		Grave cut: <i>/</i>		Finds	
Section no:		Skeleton: <i>734</i>		None	
Co-ordinates:		Matrix location: <i>733</i> <i>734</i>		Breastplate	
Levels		Preservation: <i>Good</i>		Grip	
Slide No.		Neg No:		Hinge	
Description				Bracket	
Discussion				Fixing nails	
Shape, dimensions and distinguishing characteristics				Shroud pins	
LID				Fabric	
HEAD				Other finds	
BASE					
Recorder: <i>D. Hall</i>		Date: <i>19.10.00</i>		Initials:	

**Outer Coffin**

Sample Ret.

Site Code

Context

Recording Date ..... 22/2/01 .....

OK200

734

Associated Numbers .....

Condition .....

Dep. Plate

Legible

Inscription

Fabric lead  ormolou  brass  tin plated pewter  gilt tin   
 iron  silvered tin  enamelled  other ..... Sample Ret.

**Shape of dep. plate**

square  rectangle  shield  tapered  lozenge   
 cartouche  oval  other .....

**Upholstery**

colour ..... shoddy  velvet  other ..... Sample Ret.

**Construction** butt joint  mitred  pitched  other .....

**Grip plate**  Fabric = ormolou  brass  tin plated pewter  gilt tin   
 iron  *frags on rev of grip-wood* silvered tin  enamelled  other ..... Sample Ret.

**Grip**  Fabric = ormolou  brass  iron  *x3* Sample Ret.

**Design** swag of rose  horseshoe  cherub's head  *(36)15* plain

other .....

**Grip bolts**  **Corner bolts**  **Type =** gilt brass  brass  iron

other ..... Sample Ret.

**Lid motifs**  other ..... Sample Ret.

**Escutcheons**  other ..... Sample Ret.

**Upholstery** *studs*  brass  gilt brass  silvered brass  iron  enamelled

other ..... *3 pieces 1 x 80 / 1 x 1000 / 1 x 1000 = 18 studs.* Sample Ret.

**Fixings**  panel nails  screws  hinges  lace  Sample Ret.

**Timber type** ..... Sample Ret.

**Interpretation / Comments**

.....  
 .....



SITE <i>OLROC</i>		COFFIN RECORD SHEET	CONTEXT NO. <i>735</i>
Trench:	Additional sheets:	Treatment:	
Site sub-div: <i>NC</i>	Grave fills		
Plan no: <i>3</i>	Grave cut:	Finds	
Section no:	Skeleton: <i>735</i>	None	
Co-ordinates:	Matrix location:	Breastplate	
Levels	Preservation:	Grip	
Slide No.	Neg No:	Hinge	
Description <del>.....</del> head:		Bracket	
<i>G-w Adult L very fragmentary</i>		Fixing nails	
<i>bit fairly complete</i>		Shroud pins	
Discussion		Fabric	
		Other finds	
Shape, dimensions and distinguishing characteristics			
LID			
HEAD			
BASE			
Recorder: <i>[Signature]</i>	Date: <i>20.10.00.</i>	Initials:	

SITE <i>OLROU</i>		COFFIN RECORD SHEET	CONTEXT NO. <i>736</i>
Trench:	Additional sheets: <i>463x1</i>	Treatment:	
Site sub-div: <i>NC</i>	Grave fills	<i>B.C.</i>	
Plan no: <i>3</i>	Grave cut:	Finds	
Section no:	Skeleton:	None	
Co-ordinates:	Matrix location: <i>735</i> <i>736</i>	Breastplate	
Levels	Preservation: <i>739</i> <i>GOOD</i>	Grip	
Slide No.	Neg No:	Hinge	
Description <i>G-W Adult</i>		Bracket	
Discussion		Fixing nails	
Shape, dimensions and distinguishing characteristics		Shroud pins	
LID		Fabric	
HEAD		Other finds	
BASE			
Recorder: <i>[Signature]</i>	Date: <i>19/10/00</i>	Initials: <i>[Initials]</i>	

# Coffin Recording Sheet

Site Code

Context

**Outer Coffin**

Sample Ret.

OL200

736

Recording Date ..... 13/2/01 .....

Associated Numbers .....

Condition .....

Dep. Plate

Legible

Inscription

Fabric lead  ormolou  brass  tin plated pewter  gilt tin   
 iron  silvered tin  enamelled  other ..... Sample Ret.

**Shape of dep. plate**

square  rectangle  shield  tapered  lozenge   
 cartouche  oval  other .....

**Upholstery**

colour ..... shoddy  velvet  other ..... Sample Ret.

**Construction**

butt joint  mitred  pitched  other .....

Grip plate  Fabric = ormolou  brass  tin plated pewter  gilt tin   
 iron  silvered tin  enamelled  other ..... Sample Ret.

Grip  Fabric = ormolou  brass  iron  x3 Sample Ret.

Design swag of rose  horseshoe  cherub's head  ④15 plain   
 other .....

Grip bolts  Corner bolts  Type = gilt brass  brass  iron

other ..... Sample Ret.

Lid motifs  other ..... Sample Ret.

Escutcheons  other ..... Sample Ret.

Upholstery nails  brass  gilt brass  silvered brass  iron  enamelled   
 other ..... Sample Ret.

Fixings  panel nails  screws  hinges  lace  Sample Ret.

Timber type ..... Sample Ret.

**Interpretation / Comments**

.....  
 .....

SITE <i>OLR00</i>		COFFIN RECORD SHEET		CONTEXT NO. <i>737</i>	
Trench:		Additional sheets:		Treatment:	
Site sub-div: <i>NC</i>		Grave fills		<i>B.C.</i>	
Plan no: <i>3</i>		Grave cut:		Finds	
Section no:		Skeleton: <i>737</i>		None	
Co-ordinates:		Matrix location: <i>737</i> <i>738</i>		Breastplate	
Levels		Preservation: <i>GOOD</i>		Grip	
Slide No.		Neg No:		Hinge	
Description		<i>6-W Adult burials 738</i>		Bracket	
Discussion				Fixing nails	
Shape, dimensions and distinguishing characteristics				Shroud pins	
LID				Fabric	
HEAD				Other finds	
BASE					
Recorder: <i>JR</i>		Date: <i>19/10/00</i>		Initials:	

SITE		COFFIN RECORD SHEET		CONTEXT NO.	
04200				738	
Trench:		Additional sheets		Treatment:	
Site sub-div:		Grave fills		B.C.	
Plan no:		Grave cut:		Finds	
3				None	
Section no:		Skeleton:		Breastplate	
				Grip	
Co-ordinates:		Matrix location:		Hinge	
		737		Bracket	
		738		Fixing nails	
Levels		Preservation:		Shroud pins	
		740			
		GOOD			
Slide No.		Neg No:		Fabric	
				Other finds	
Description					
G-W Adult Truncated by 737, <del>...</del>					
Discussion					
Shape, dimensions and distinguishing characteristics					
LID					
HEAD					
BASE					
Recorder:		Date:		Initials:	
[Signature]		12/10/00			

Site Code

Context

**Outer Coffin**

Sample Ret.

OL200

738

Recording Date ..... 13/2/01 .....

Associated Numbers .....

Condition .....

Dep. Plate

Legible

Inscription

Fabric lead  ormolou  brass  tin plated pewter  gilt tin   
 iron  silvered tin  enamelled  other ..... Sample Ret.

**Shape of dep. plate**

square  rectangle  shield  tapered  lozenge   
 cartouche  oval  other .....

**Upholstery**

colour ..... shoddy  velvet  other ..... Sample Ret.

**Construction**

butt joint  mitred  pitched  other .....

**Grip plate**

Fabric = ormolou  brass  tin plated pewter  gilt tin   
*Fragson lev of grip-unid.*  
 iron  silvered tin  enamelled  other ..... Sample Ret.

**Grip**

Fabric = ormolou  brass  iron  *x3* Sample Ret.

**Design**

swag of rose  horseshoe  cherub's head  *228b* plain

other .....

**Grip bolts**

**Corner bolts**  Type = gilt brass  brass  iron

other ..... Sample Ret.

**Lid motifs**

other ..... Sample Ret.

**Escutcheons**

other ..... Sample Ret.

**Upholstery nails**

brass  gilt brass  silvered brass  iron  enamelled

other ..... Sample Ret.

**Fixings**

panel nails  screws  hinges  lace  Sample Ret.

**Timber type**

..... Sample Ret.

**Interpretation / Comments**

.....  
 .....

db

SITE OLROC		COFFIN RECORD SHEET	CONTEXT NO. 739
Trench:	Additional sheets: 465 x 1.		Treatment: B.C.
Site sub-div: NC	Grave fills		
Plan no: 3	Grave cut:		Finds None
Section no:	Skeleton: 739		Breastplate Grip
Co-ordinates:	Matrix location: 736 739		Hinge Bracket
Levels	Preservation: FAIR		Fixing nails Shroud pins
Slide No.	Neg No:		Fabric Other finds
Description 6-w skull			
Discussion			
Shape, dimensions and distinguishing characteristics			
LID			
HEAD			
BASE			
Recorder: JW	Date: 17/10/01		Initials:

Site Code

Context

**Outer Coffin**

Sample Ret.

OR200

739

Recording Date ..... 14/12/00 .....

Associated Numbers .....

Condition .....

Dep. Plate

Legible

Inscription

Fabric lead  ormolou  brass  tin plated pewter  gilt tin   
iron  silvered tin  enamelled  other ..... Sample Ret.

**Shape of dep. plate**

square  rectangle  shield  tapered  lozenge   
cartouche  oval  other .....

**Upholstery**

colour ..... shoddy  velvet  other ..... Sample Ret.

**Construction**

butt joint  mitred  pitched  other .....

**Grip plate**

Fabric = ormolou  brass  tin plated pewter  gilt tin   
*frag on lev. of grip - unid*  
 iron  silvered tin  enamelled  other ..... Sample Ret.

**Grip**

Fabric = ormolou  brass  iron  *X1* Sample Ret.

**Design**

swag of rose  horseshoe  cherub's head  *(2a)* plain

other .....

**Grip bolts**

**Corner bolts**  Type = gilt brass  brass  iron

other ..... Sample Ret.

**Lid motifs**

other ..... Sample Ret.

**Escutcheons**

other ..... Sample Ret.

**Upholstery**

*shuds*  
~~nails~~  brass  gilt brass  silvered brass  iron  *X1* enamelled

other ..... *shud cone to bolt thickening of grip* Sample Ret.

**Fixings**

panel nails  screws  hinges  lace  Sample Ret.

**Timber type**

..... Sample Ret.

**Interpretation / Comments**

.....  
.....



SITE	COFFIN RECORD SHEET	CONTEXT NO.
Trench:	Additional sheets:	Treatment:
Site sub-div: NC	Grave fills	B.C.
Plan no: 3	Grave cut:	Finds None
Section no:	Skeleton: 740	Breastplate Grip
Co-ordinates:	Matrix location: 738 740	Hinge Bracket
Levels	Preservation: FAIR	Fixing nails Shroud pins
Slide No.	Neg No:	Fabric Other finds
Description 6-w skull truncated by 737/738		
Discussion		
Shape, dimensions and distinguishing characteristics		
Recorder: JH Date: 11/10/00 Initials:		

SITE		COFFIN RECORD SHEET		CONTEXT NO.	
OLROU				741	
Trench:		Additional sheets: VES XI		Treatment:	
Site sub-div: NC		Grave fills		B.C.	
Plan no: 3		Grave cut:		Finds	
Section no:		Skeleton: 741		None	
Co-ordinates:		Matrix location: 741		Breastplate	
Levels		Preservation: GOOD		Grip	
Slide No.		Neg No:		Hinge	
Description		6-W BURIAL (SOULS BODY)		Bracket	
Discussion				Fixing nails	
Shape, dimensions and distinguishing characteristics				Shroud pins	
LID				Fabric	
HEAD				Other finds	
BASE					
Recorder: JR		Date: 19/10/00		Initials:	

# Coffin Recording Sheet

Site Code

Context

**Outer Coffin**

Sample Ret.

OL200

741

Recording Date ..... 13/2/01 .....

Associated Numbers .....

Condition .....

Dep. Plate

Legible

**Inscription**

Fabric lead  ormolou  brass  tin plated pewter  gilt tin   
 iron  silvered tin  enamelled  other ..... Sample Ret.

**Shape of dep. plate**

square  rectangle  shield  tapered  lozenge   
 cartouche  oval  other .....

**Upholstery**

colour ..... shoddy  velvet  other ..... Sample Ret.

**Construction**

butt joint  mitred  pitched  other .....

Grip plate  Fabric = ormolou  brass  tin plated pewter  gilt tin   
 iron  silvered tin  enamelled  other ..... Sample Ret.

Grip  Fabric = ormolou  brass  iron  x1 Sample Ret.

Design swag of rose  horseshoe  cherub's head  (4) plain   
 other .....

Grip bolts  Corner bolts  Type = gilt brass  brass  iron   
 other ..... Sample Ret.

Lid motifs  other ..... Sample Ret.

Escutcheons  other ..... Sample Ret.

Upholstery nails  brass  gilt brass  silvered brass  iron  enamelled   
 other ..... Sample Ret.

Fixings  panel nails  screws  hinges  lace  Sample Ret.

Timber type ..... Sample Ret.

**Interpretation / Comments**

.....  
 .....

SITE <u>02R00</u>		COFFIN RECORD SHEET		CONTEXT NO. <u>742</u>	
Trench:		Additional sheets: <u>WESX1</u>		Treatment:	
Site sub-div: <u>NC</u>		Grave fills		<u>B.C.</u>	
Plan no: <u>3</u>		Grave cut:		Finds	
Section no:		Skeleton: <u>742</u>		None	
Co-ordinates:		Matrix location: <u>742</u> <u>745</u>		Breastplate	
Levels		Preservation: <u>FAIR</u>		Grip	
Slide No.		Neg No:		Hinge	
Description <u>6-w Adult</u>				Bracket	
Discussion				Fixing nails	
Shape, dimensions and distinguishing characteristics				Shroud pins	
LID				Fabric	
HEAD				Other finds	
BASE					
Recorder: <u>JW</u>		Date: <u>20/10/00</u>		Initials:	

Site Code

Context

**Outer Coffin**

Sample Ret.

*OLR00*

*742*

Recording Date ..... *13/2/01.*

Associated Numbers .....

Condition .....

Dep. Plate

Legible

Inscription

Fabric lead       ormolou       brass       tin plated pewter       gilt tin   
 iron       silvered tin       enamelled       other .....      Sample Ret.

**Shape of dep. plate**

square       rectangle       shield       tapered       lozenge   
 cartouche       oval       other .....

**Upholstery**

colour .....      shoddy       velvet       other .....      Sample Ret.

**Construction**

butt joint       mitred       pitched       other .....

Grip plate       Fabric = ormolou       brass       tin plated pewter       gilt tin   
 iron       silvered tin       enamelled       other .....      Sample Ret.

Grip  Fabric = ormolou       brass       iron       Sample Ret.

Design      swag of rose       horseshoe       cherub's head       *(3b)*      plain   
 other .....

Grip bolts       Corner bolts       Type =      gilt brass       brass       iron   
 other .....      Sample Ret.

Lid motifs       other .....

Escutcheons       other .....

Upholstery ~~nails~~ <sup>studs</sup>       brass       gilt brass       silvered brass       iron       enamelled   
 other ..... *3 x pins - 1 x 00000/2 x 000 = 11 studs*      Sample Ret.

Fixings       panel nails       screws       hinges       lace       Sample Ret.

Timber type .....      Sample Ret.

**Interpretation / Comments**

.....  
 .....

SITE	COFFIN RECORD SHEET	CONTEXT NO.
Trench:	Additional sheets:	Treatment: B.C.
Site sub-div: NC	Grave fills /	
Plan no: 3	Grave cut: /	Finds None
Section no:	Skeleton: 743	Breastplate Grip
Co-ordinates:	Matrix location: 743 744	Hinge Bracket
Levels	Preservation: Good	Fixing nails Shroud pins
Slide No.	Neg No:	Fabric Other finds
Description E-W Adult burial,		
Discussion		
Shape, dimensions and distinguishing characteristics		
LID		
HEAD		
BASE		
Recorder: D. Ham	Date: 20.10.00	Initials:

SITE <i>OLR 50</i>		COFFIN RECORD SHEET		CONTEXT NO. <i>744</i>	
Trench:		Additional sheets:		Treatment: <i>B.C.</i>	
Site sub-div: <i>NC</i>		Grave fills <i>/</i>			
Plan no: <i>3</i>		Grave cut: <i>/</i>		Finds	
Section no:		Skeleton: <i>744</i>		None	
Co-ordinates:		Matrix location: <i>743</i> <i>744</i>		Breastplate	
Levels		Preservation: <i>FAIR.</i>		Grip	
Slide No.		Neg No:		Hinge	
				Bracket	
				Fixing nails	
				Shroud pins	
				Fabric	
				Other finds	
<p>Description <i>E-W Adult burial - collected from machine bucket due to its being in edge of 2.5m section.</i></p> <p>Discussion</p> <p>Shape, dimensions and distinguishing characteristics</p> <p>LID</p> <p>HEAD</p> <p>BASE</p>					
Recorder: <i>DHAM</i>		Date: <i>20-10-50</i>		Initials:	

SITE <i>OR 00</i>		COFFIN RECORD SHEET		CONTEXT NO. <i>745</i>	
Trench:		Additional sheets:		Treatment: <i>D.C.</i>	
Site sub-div: <i>N2</i>		Grave fills <i>/</i>			
Plan no: <i>3</i>		Grave cut: <i>/</i>		Finds	
Section no:		Skeleton: <i>746</i>		None	
Co-ordinates:		Matrix location: <i>742</i> <i>746</i>		Breastplate	
Levels		Preservation: <i>POOR.</i>		Grip	
Slide No.		Neg No:		Hinge	
				Bracket	
				Fixing nails	
				Shroud pins	
				Fabric	
				Other finds	
Description <i>E-W Adult burial, truncated by 742. Machined out due to 2.5m section.</i>					
Discussion					
Shape, dimensions and distinguishing characteristics					
LID					
HEAD					
BASE					
Recorder: <i>DHAM</i>		Date: <i>20-10-00-</i>		Initials:	



SITE <u>OLR 00</u>		COFFIN RECORD SHEET	CONTEXT NO. <u>746</u>
Trench:	Additional sheets: <u>yes x1</u>	Treatment: <u>B.C.</u>	
Site sub-div: <u>NE</u>	Grave fills: <u>/</u>		
Plan no: <u>3</u>	Grave cut: <u>/</u> <del>SA</del>	Finds None	
Section no:	Skeleton: <u>746</u>	Breastplate Grip	
Co-ordinates:	Matrix location: <u>749</u> <u>746</u>	Hinge Bracket	
Levels	Preservation: <u>FAIR.</u>	Fixing nails Shroud pins	
Slide No.	Neg No:	Fabric Other finds	
Description <u>E-W adult burial, machined out due to 2.5m section.</u>			
Discussion			
Shape, dimensions and distinguishing characteristics			
LID			
HEAD			
BASE			
Recorder: <u>D. Azm</u>	Date: <u>20.10.00.</u>	Initials:	

# Coffin Recording Sheet

Site Code

Context

**Outer Coffin**

Sample Ret.

06200

746

Recording Date ..... 13/2/01

Associated Numbers .....

Condition .....

Dep. Plate

Legible

Inscription

Fabric lead  ormolou  brass  tin plated pewter  gilt tin   
 iron  silvered tin  enamelled  other ..... Sample Ret.

**Shape of dep. plate**

square  rectangle  shield  tapered  lozenge   
 cartouche  oval  other .....

**Upholstery**

colour: ..... shoddy  velvet  other ..... Sample Ret.

**Construction**

butt joint  mitred  pitched  other .....

Grip plate  Fabric = ormolou  brass  tin plated pewter  gilt tin   
 iron  silvered tin  enamelled  other ..... Sample Ret.

Grip  Fabric = ormolou  brass  iron  Sample Ret.

Design swag of rose  horseshoe  cherub's head  plain   
 other .....

Grip bolts  Corner bolts  Type = gilt brass  brass  iron   
 other ..... Sample Ret.

Lid motifs  other ..... Sample Ret.

Escutcheons  other ..... Sample Ret.

Upholstery <sup>studs</sup> nails  brass  gilt brass  silvered brass  iron  enamelled   
 other ..... 1 x 0000 / 2 x 00 = 8 studs. Sample Ret.

Fixings  panel nails  screws  hinges  lace  Sample Ret.

Timber type ..... Sample Ret.

**Interpretation / Comments**

.....  
 .....

SITE	COFFIN RECORD SHEET	CONTEXT NO.
02200		747
Trench:	Additional sheets:	Treatment:
Site sub-div: NC	Grave fills	B.C.
Plan no: 3	Grave cut:	Finds None
Section no:	Skeleton: 747	Breastplate Grip <input checked="" type="checkbox"/>
Co-ordinates:	Matrix location:	Hinge Bracket
Levels	Preservation: Poor	Fixing nails Shroud pins
Slide No.	Neg No:	Fabric Other finds
<b>Description</b> E-W Adult fell out of section at edge of site 2.5m section		
<b>Discussion</b>		
<b>Shape, dimensions and distinguishing characteristics</b>		
<b>LID</b>		
<b>HEAD</b>		
<b>BASE</b>		
Recorder: <i>JR</i>	Date: 20/10/00	Initials:

# Coffin Recording Sheet

Site Code

Context

ORL00

747

**Outer Coffin**

Sample Ret.

Recording Date ..... 16/2/01 .....

Associated Numbers .....

Condition .....

Dep. Plate

Legible

Inscription

Fabric lead  ormolou  brass  tin plated pewter  gilt tin   
 iron  silvered tin  enamelled  other ..... Sample Ret.

**Shape of dep. plate**

square  rectangle  shield  tapered  lozenge   
 cartouche  oval  other .....

**Upholstery**

colour ..... shoddy  velvet  other *bozze* ..... Sample Ret.

**Construction** butt joint  mitred  pitched  other .....

**Grip plate**  Fabric = ormolou  brass  tin plated pewter  gilt tin   
 iron  silvered tin  enamelled  other ..... Sample Ret.

**Grip**  Fabric = ormolou  brass  iron  *x1* Sample Ret.

**Design** swag of rose  horseshoe  cherub's head  **(3b)** plain   
 other .....

**Grip bolts**  **Corner bolts**  **Type =** gilt brass  brass  iron   
 other ..... Sample Ret.

**Lid motifs**  other ..... Sample Ret.

**Escutcheons**  other ..... Sample Ret.

**Upholstery** <sup>shuds</sup> nails  brass  gilt brass  silvered brass  iron  enamelled   
 other ..... *3 x pieces / 1x 00000000 / 2x 000 = 2A studs* ..... Sample Ret.

**Fixings**  panel nails  screws  hinges  lace  Sample Ret.

**Timber type** ..... Sample Ret.

**Interpretation / Comments**

.....  
 .....

SITE	COFFIN RECORD SHEET	CONTEXT NO.
02R 00		1748
Trench:	Additional sheets:	Treatment: B.C.
Site sub-div: N-C	Grave fills /	
Plan no: 3	Grave cut: /	Finds
Section no:	Skeleton: 748	None Breastplate Grip
Co-ordinates:	Matrix location: <del>746</del> 748 <del>748</del> 748	Hinge Bracket
Levels	Preservation: FAIR.	Fixing nails Shroud pins
Slide No.	Neg No:	Fabric Other finds
<p>Description E-W Baby burial. o/lying 746, machined out due to 2.5m section.</p> <p>Discussion</p>		
<p>Shape, dimensions and distinguishing characteristics</p> <p>LID</p> <p>HEAD</p> <p>BASE</p>		
Recorder: D. HAM	Date: 20.10.00.	Initials:

SITE	COFFIN RECORD SHEET	CONTEXT NO.
OLR00		747
Trench:	Additional sheets: YES x 1	Treatment:
Site sub-div: NC	Grave fills	BC
Plan no: 3	Grave cut:	Finds
Section no:	Skeleton:	None
Co-ordinates:	Matrix location: 748 1 749 1	Breastplate
Levels	Preservation: 746 GOOD	Grip
Slide No.	Neg No:	Hinge
		Bracket
		Fixing nails
		Shroud pins
		Fabric
		Other finds

**Description** E-W Bulb overlies 746, Machined out due to 2.5m section.

**Discussion**

**Shape, dimensions and distinguishing characteristics**

LID

HEAD

BASE

Recorder: JPR	Date: 22/10/00	Initials:
---------------	----------------	-----------

# Coffin Recording Sheet

Site Code

Context

**Outer Coffin**

Sample Ret.

*Oh200*

*749*

Recording Date ..... *13/2/01* .....

Associated Numbers .....

Condition .....

Dep. Plate

Legible

Inscription

Fabric lead       ormolou       brass       tin plated pewter       gilt tin   
 iron       silvered tin       enamelled       other .....      Sample Ret.

**Shape of dep. plate**

square       rectangle       shield       tapered       lozenge   
 cartouche       oval       other .....

**Upholstery**

colour .....      shoddy       velvet       other .....      Sample Ret.

**Construction**

butt joint       mitred       pitched       other .....

Grip plate       Fabric = ormolou       brass       tin plated pewter       gilt tin   
 iron       silvered tin       enamelled       other .....      Sample Ret.

Grip       Fabric = ormolou       brass       iron  *x*      Sample Ret.

Design      swag of rose       horseshoe       cherub's head       plain   
 other ..... *↔ 0.12*      *↑ 0.04*      *infant ①*

Grip bolts       Corner bolts       Type =      gilt brass       brass       iron

other .....      Sample Ret.

Lid motifs       other .....      Sample Ret.

Escutcheons       other .....      Sample Ret.

Upholstery *studs*       brass       gilt brass       silvered brass       iron       enamelled   
 other ..... *3 x singles* .....      Sample Ret.

Fixings       panel nails       screws       hinges       lace       Sample Ret.

Timber type .....      Sample Ret.

**Interpretation / Comments**

.....  
 .....

SITE <i>our 00</i>		COFFIN RECORD SHEET	CONTEXT NO. <i>750</i>
Trench:	Additional sheets:	Treatment: <i>B.C.</i>	
Site sub-div: <i>NC</i>	Grave fills <i>/</i>		
Plan no: <i>3</i>	Grave cut: <i>/</i>	Finds None	
Section no:	Skeleton: <i>750</i>	Breastplate Grip	
Co-ordinates:	Matrix location: <i>747</i> <i>750</i>	Hinge Bracket	
Levels	Preservation: <i>PAK.</i>	Fixing nails Shroud pins	
Slide No.	Neg No:	Fabric Other finds	
Description <i>E-W Adult burial, fell out of 2.5m section, machine bucket collection.</i>			
Discussion			
Shape, dimensions and distinguishing characteristics			
LID			
HEAD			
BASE			
Recorder: <i>DHAM</i>	Date: <i>20.10.50</i>	Initials:	



SITE <i>02R00</i>		COFFIN RECORD SHEET	CONTEXT NO. <i>751</i>
Trench:	Additional sheets:	Treatment: <i>B.C.</i>	
Site sub-div: <i>NC</i>	Grave fills		
Plan no: <i>3</i>	Grave cut:	Finds None <input checked="" type="checkbox"/>	
Section no:	Skeleton:	Breastplate Grip	
Co-ordinates:	Matrix location: <i>751</i> <i>752</i>	Hinge Bracket	
Levels	Preservation: <i>Good.</i>	Fixing nails Shroud pins	
Slide No.	Neg No:	Fabric Other finds	
Description <i>E-W child burial.</i>			
Discussion			
Shape, dimensions and distinguishing characteristics			
LID			
HEAD			
BASE			
Recorder: <i>D. Ham</i>	Date: <i>20.10.00</i>	Initials:	

SITE	COFFIN RECORD SHEET	CONTEXT NO.
OLR 00	Additional sheets:	752
Trench:	Grave fills	Treatment: B.C.
Site sub-div: NC	Grave cut: /	Finds
Plan no: 3	Skeleton: 752	None
Section no:	Matrix location: 751 752	Breastplate
Co-ordinates:	Preservation: poor.	Grip
Levels	Slide No.	Hinge
Slide No.	Neg No:	Bracket
Description	Neg No:	Fixing nails
Discussion	Neg No:	Shroud pins
Shape, dimensions and distinguishing characteristics	Neg No:	Fabric
LID	Neg No:	Other finds
HEAD	Neg No:	:
BASE	Neg No:	:
Recorder: D. Ham	Date: 20.10.06	Initials:

SITE <i>OLR 00</i>		COFFIN RECORD SHEET	CONTEXT NO. <i>753</i>
Trench:	Additional sheets: <i>YES X1</i>	Treatment: <i>B.C.</i>	
Site sub-div: <i>NC</i>	Grave fills <i>/</i>		
Plan no: <i>3</i>	Grave cut: <i>/</i>	Finds None	
Section no:	Skeleton: <i>753</i>	Breastplate Grip	
Co-ordinates:	Matrix location: <i>753</i> <i>755</i>	Hinge Bracket	
Levels	Preservation: <i>GOOD.</i>	Fixing nails Shroud pins	
Slide No.	Neg No:	Fabric Other finds :	
Description <i>E-W Adult bur-1.</i>			
Discussion			
Shape, dimensions and distinguishing characteristics			
LID			
HEAD			
BASE			
Recorder: <i>DH</i>	Date: <i>20.10.00.</i>	Initials:	

# Coffin Recording Sheet

Site Code

Context

**Outer Coffin**

Sample Ret.

OR100

753

Recording Date ..... 12/2/01 .....

Associated Numbers .....

Condition .....

Dep. Plate

Legible

Inscription

Fabric lead  ormolou  brass  tin plated pewter  gilt tin   
 iron  silvered tin  enamelled  other ..... Sample Ret.

**Shape of dep. plate**

square  rectangle  shield  tapered  lozenge   
 cartouche  oval  other .....

**Upholstery**

colour ..... shoddy  velvet  other *bolts on REV of studs* ..... Sample Ret.

**Construction**

butt joint  mitred  pitched  other .....

**Grip plate**

Fabric = ormolou  brass  tin plated pewter  gilt tin   
 iron  *x3 fragmented 2286* silvered tin  enamelled  other ..... Sample Ret.

**Grip**

Fabric = ormolou  brass  iron  *x5* Sample Ret.

**Design**

swag of rose  horseshoe  cherub's head  *2286* plain

other .....

**Grip bolts**

Corner bolts  Type = gilt brass  brass  iron

other ..... Sample Ret.

**Lid motifs**

other ..... Sample Ret.

**Escutcheons**

other ..... Sample Ret.

**Upholstery nails**

*studs*  
 brass  gilt brass  silvered brass  iron  enamelled   
 other *x5 pieces / 1x 0000 / 1x 00000 / 1x 00000 / 1x 000000 / 1x 000000 = 37 studs* Sample Ret.

**Fixings**

panel nails  screws  hinges  lace  Sample Ret.

**Timber type**

Sample Ret.

**Interpretation / Comments**

.....  
 .....

SITE <b>OLR 00</b>		COFFIN RECORD SHEET		CONTEXT NO. <b>754</b>	
Trench:		Additional sheets:		Treatment:	
Site sub-div: <b>NC</b>		Grave fills <b>/</b>		<b>B.C.</b>	
Plan no: <b>3</b>		Grave cut: <b>/</b>		Finds	
Section no:		Skeleton: <b>754</b>		None	
Co-ordinates:		Matrix location: <b>754</b>		Breastplate	
Levels		Preservation:		Grip	
Slide No.		Neg No:		Hinge	
Description				Bracket	
Discussion				Fixing nails	
Shape, dimensions and distinguishing characteristics				Shroud pins	
LID				Fabric	
HEAD				Other finds	
BASE					
Recorder: <b>D Hall</b>		Date: <b>20.10.00.</b>		Initials:	

**E-W Baby burial. No relationships.**  
 Remains of younger individual - 1311 -  
 recovered during osteological analysis.

SITE <i>OLR 00</i>		COFFIN RECORD SHEET		CONTEXT NO. <i>755</i>	
Trench:		Additional sheets:		Treatment: <i>B.C.</i>	
Site sub-div: <i>NL</i>		Grave fills <i>/</i>			
Plan no: <i>3</i>		Grave cut: <i>/</i>		Finds	
Section no:		Skeleton: <i>755</i>		None	
Co-ordinates:		Matrix location: <i>753</i> <i>755</i> <i>756</i>		Breastplate	
Levels		Preservation: <del>look</del> <i>look.</i>		Grip	
Slide No.		Neg No:		Hinge	
Description				Bracket	
Discussion				Fixing nails	
Shape, dimensions and distinguishing characteristics				Shroud pins	
LID				Fabric	
HEAD				Other finds	
BASE					
Recorder: <i>DHAM</i>		Date: <i>20-10-00</i>		Initials:	

*E-W A baby Burial, possibly truncated by 753 due to absence of skull etc.*

SITE <i>OLR 00</i>		COFFIN RECORD SHEET		CONTEXT NO. <i>756</i>	
Trench:		Additional sheets:		Treatment: <i>B.C.</i>	
Site sub-div: <i>NC</i>		Grave fills <i>/</i>			
Plan no: <i>3</i>		Grave cut: <i>/</i>		Finds	
Section no:		Skeleton: <i>756</i>		None	
Co-ordinates:		Matrix location: <i>755</i> <i>756</i>		Breastplate	
Levels		Preservation: <i>Good.</i>		Grip	
Slide No.		Neg No:		Hinge	
Description <i>E-W Adult male.</i>				Bracket	
Discussion				Fixing nails	
Shape, dimensions and distinguishing characteristics				Shroud pins	
LID				Fabric	
HEAD				Other finds	
BASE					
Recorder: <i>DHAM</i>		Date: <i>20.10.00</i>		Initials:	

Site Code

Context

**Outer Coffin**

Sample Ret.

OLR00

757

Recording Date ..... 16/2/01

Associated Numbers .....

Condition .....

Dep. Plate

Legible

Inscription

Fabric lead  ormolou  brass  tin plated pewter  gilt tin   
 iron  silvered tin  enamelled  other ..... Sample Ret.

**Shape of dep. plate**

square  rectangle  shield  tapered  lozenge   
 cartouche  oval  other .....

**Upholstery**

colour ..... shoddy  velvet  other ..... Sample Ret.

**Construction**

butt joint  mitred  pitched  other .....

**Grip plate**

Fabric = ormolou  brass  tin plated pewter  gilt tin   
*Frags of 228b*  
 iron  silvered tin  enamelled  other ..... Sample Ret.

**Grip**

Fabric = ormolou  brass  iron  x3 Sample Ret.

**Design**

swag of rose  horseshoe  cherub's head  2280 plain

other .....

**Grip bolts**

**Corner bolts**  Type = gilt brass  brass  iron

other ..... Sample Ret.

**Lid motifs**

other .....

Sample Ret.

**Escutcheons**

other .....

Sample Ret.

**Upholstery nails**

brass  gilt brass  silvered brass  iron  enamelled

other ..... Sample Ret.

**Fixings**

panel nails  screws  hinges  lace  Sample Ret.

**Timber type**

Sample Ret.

**Interpretation / Comments**

.....  
 .....





SITE <b>OLR00</b>		COFFIN RECORD SHEET		CONTEXT NO. <b>758</b>	
Trench:		Additional sheets:		Treatment:	
Site sub-div: <b>NC</b>		Grave fills <b>/</b>		<b>B.C.</b>	
Plan no: <b>3</b>		Grave cut: <b>181</b>		Finds	
Section no:		Skeleton: <b>758</b>		None	
Co-ordinates:		Matrix location: <b>758</b> <b>759</b>		Breastplate	
Levels		Preservation: <b>Poor.</b>		Grip	
Slide No.		Neg No:		Hinge	
				Bracket	
				Fixing nails	
				Shroud pins	
				Fabric	
				Other finds	
Description <b>E-W Adult burial, poorly preserved due to later truncation of grave by construction of vault 174</b>					
Discussion					
Shape, dimensions and distinguishing characteristics					
LID					
HEAD					
BASE					
Recorder: <b>D. Ann</b>		Date: <b>20.10.50.</b>		Initials:	

# Coffin Recording Sheet

Site Code

Context

**Outer Coffin**

Sample Ret.

04200

758

Recording Date ..... 15/2/01 .....

Associated Numbers .....

Condition .....

Dep. Plate

Legible

Inscription

Fabric lead       ormolou       brass       tin plated pewter       gilt tin   
 iron       silvered tin       enamelled       other .....      Sample Ret.

**Shape of dep. plate**

square       rectangle       shield       tapered       lozenge   
 cartouche       oval       other .....

**Upholstery**

colour .....      shoddy       velvet       other .....      Sample Ret.

**Construction**

butt joint       mitred       pitched       other .....

**Grip plate**

Fabric = ormolou       brass       tin plated pewter       gilt tin

iron       *frag on rev of grip - unid.*      silvered tin       enamelled       other .....      Sample Ret.

**Grip**

Fabric = ormolou       brass       iron       Sample Ret.

**Design**

swag of rose       horseshoe       cherub's head       plain

other .....

**Grip bolts**

**Corner bolts**       Type =      gilt brass       brass       iron

other .....      Sample Ret.

**Lid motifs**

other .....      Sample Ret.

**Escutcheons**

other .....      Sample Ret.

**Upholstery nails**

brass       gilt brass       silvered brass       iron       enamelled

other .....      Sample Ret.

**Fixings**

panel nails       screws       hinges       lace       Sample Ret.

**Timber type**

Sample Ret.

**Interpretation / Comments**

.....  
 .....

SITE	COFFIN RECORD SHEET	CONTEXT NO.
GLR 00		759
Trench:	Additional sheets:	Treatment:
Site sub-div: NC	Grave fills /	B.C.
Plan no: 3	Grave cut: 181	Finds
Section no:	Skeleton: 759	None
Co-ordinates:	Matrix location: 758	Breastplate
Levels	759	Grip
Slide No.	Preservation: POOR	Hinge
Neg No:		Bracket
Fabric		Fixing nails
Other finds		Shroud pins
Description: E-W Adult burial, poor preservation due to being truncated by construction of vault 174.		
Discussion		
Shape, dimensions and distinguishing characteristics		
LID		
HEAD		
BASE		
Recorder: D. Azm	Date: 20.10.50.	Initials:

# Coffin Recording Sheet

Site Code

Context

**Outer Coffin**

Sample Ret.

06200

759

Recording Date ..... 19/2/01 .....

Associated Numbers .....

Condition .....

Dep. Plate

Legible

Inscription

Fabric lead  ormolou  brass  tin plated pewter  gilt tin   
 iron  silvered tin  enamelled  other ..... Sample Ret.

**Shape of dep. plate**

square  rectangle  shield  tapered  lozenge   
 cartouche  oval  other .....

**Upholstery**

colour ..... shoddy  velvet  other ..... Sample Ret.

**Construction**

butt joint  mitred  pitched  other .....

**Grip plate**  Fabric = ormolou  brass  tin plated pewter  gilt tin   
 iron  silvered tin  enamelled  other ..... Sample Ret.

**Grip**  Fabric = ormolou  brass  iron  x 2 Sample Ret.

**Design** swag of rose  horseshoe  cherub's head  plain   
 other .....

**Grip bolts**  **Corner bolts**  **Type =** gilt brass  brass  iron

other ..... Sample Ret.

**Lid motifs**  other ..... Sample Ret.

**Escutcheons**  other ..... Sample Ret.

**Upholstery nails**  brass  gilt brass  silvered brass  iron  enamelled   
 other ..... Sample Ret.

**Fixings**  panel nails  screws  hinges  lace  Sample Ret.

**Timber type** ..... Sample Ret.

**Interpretation / Comments**

.....  
 .....

SITE	COLFİN RECORD SHEET	CONTEXT NO.
OLR 00		760
Trench:	Additional sheets:	Treatment: B.C.
Site sub-div: NC	Grave fills ✓	
Plan no: 3	Grave cut: ✓	Finds None ✓
Section no:	Skeleton: 760	Breastplate Grip
Co-ordinates:	Matrix location: 760 761	Hinge Bracket
Levels	Preservation: poor.	Fixing nails Shroud pins
Slide No.	Neg No:	Fabric Other finds

Description E-W Baby burial. Bone retrieval poor due to burial being machined out because of 2.5m depth.

Discussion



Shape, dimensions and distinguishing characteristics

LID

HEAD

BASE

Recorder: D. Ham	Date: 23.10.00	Initials:
------------------	----------------	-----------

SITE	COFFIN RECORD SHEET	CONTEXT NO.
OLR 00	Additional sheets:	761 Treatment: B.C.
Trench:	Grave fills	
Site sub-div: NC	Grave cut: /	Finds
Plan no: 3	Skeleton: 761	None ✓
Section no:	Matrix location: 760 761 795	Breastplate Grip
Co-ordinates:	Preservation: POOR.	Hinge Bracket
Levels	Neg No:	Fixing nails Shroud pins
Slide No.	Description	Fabric Other finds
<p>Description E-W child/Juvenile burial. Bone retrieval poor due to machining out because of 2.5m section.</p> <p>Discussion</p>		
<p>Shape, dimensions and distinguishing characteristics</p> <p>LID</p> <p>HEAD</p> <p>BASE</p>		
Recorder: D. Hall	Date: 23.10.00	Initials:

Islington, Old Street, S Lubes  
OLR00

Box 3 File 3

B. PRIMARY Context Records # 762-893



SCAN PDF

FILMING INSTRUCTIONS

Submitter OASouth

No. of CD copies: 2

Headings

Site information

Line 1: [OASouth] County:[Greater London] Parish:[Islington] Site:[Old Street, St Lukes]

Site code[OLR00]

Line 2: Excavators name[A. Boyle]

Line 3:

Classification of material

Tick if present

Index to archive	
Introduction	
A:Final Report	
A:Publication Report	
B:Site Data – Text: Diary/Daybook/Fieldnotes	
B: Site Data – Text: General Summaries	
B: Site Data – Text: Primary Context Records <i>Nº 762 → 893</i>	✓
B: Site Data – Text: Synthesised Context Records	
B: Site Data – Text: Survey Reports	
B: Site Data – Text: Catalogue of Drawings	
B: Site Data – Text: Primary Drawings	
B: Site Data – Text: Synthesised Drawings	
C: Finds Data – Text: Primary Finds Data	
C: Finds Data – Text: Synthesised Finds Data	
C: Finds Data – Text: Specialist Reports	
C: Finds Data – Text: Box/Bag List	
D: Catalogue of Photos/Slides/Videos/X--rays	
E: Environmental/Ecofact Data: Primary Records	
E: Environmental/Ecofact Data: Synthesised Records	
E: Environmental/Ecofact Data: Specialist Reports	
F: Documentary	
F: Press and Publicity	
G: Correspondence	
H: Miscellaneous	

SITE CODE: OLR 00		CONTEXT CHECKLIST				SITE NAME: St Luke's Church ISLINGTON		
Context No	Type	Excavated with Segments	Relationships	Dug	Drawn		Matrix NAMED?	Comments
					Section	Plan		
762	BURIAL	CRUPT, BM1 PAUL 240	U/L 725-728	BM	—	7	Y	16 c/hw INFANT
763	"	"	U/L 725-728	BM	—	7	Y	" INFANT
764	"	"	U/L 725-728	BM	—	7	Y	"
765	"	CRUPT, BM3	U/L 339	BM	—	7	Y	16 c/hw
766	"	"	U/L 339	BM	—	7	Y	"
767	"	"	"	BM	—	7	Y	"
768	"	"	"	BM	—	7	N	"
769	"	"	"	BM	—	7	Y	"
770	"	CRUPT, BM2 PAUL 95	—	BM	—	7	Y	"
771	"	"	—	BM	—	7	Y	"
772	"	CRUPT, BM3	—	BM	—	7	Y	"
773	"	"	—	BM	—	7	Y	"
774	"	"	—	BM	—	7	N	"
775	"	CRUPT, BM2	—	BM	—	7	Y	"
776	"	"	—	BM	—	7	Y	"
777	"	"	—	BM	—	7	Y	"
778	"	"	—	BM	—	7	Y	"
779	"	"	—	BM	—	7	Y	"
780	"	CRUPT, BM4	—	BM	—	7	Y	" INFANT
781	"	"	—	BM	—	7	Y	" INFANT
782	"	CRUPT, BM4	—	BM	—	7	Y	"
783	"	CRUPT, BM2	—	BM	—	7	N	"
784	"	"	—	BM	—	7	Y	"
785	"	"	—	BM	—	7	Y	"
786	"	"	—	BM	—	7	N	"
787	"	"	—	BM	—	7	N	"
788	"	"	—	BM	—	7	Y	"
789	"	"	—	BM	—	7	Y	"
790	"	CRUPT BM4	U/L 541	BM	—	7	N	"
791	"	CRUPT	BM44 & 480	BM	—	7	Y	" INFANT
792	"	"	" U/L 481	BM	—	7	Y	"
793	"	"	"	BM	—	7	Y	"
794	"	"	"	BM	—	7	Y	"

SITE CODE: OLR 00		CONTEXT CHECKLIST			SITE ST LUKE'S CHURCH, NAME: ISLINGTON			
Context No	Type	Excavated with Segments	Relationships	Dug	Drawn		Matrix NAME(s)	Comments
					Section	Plan		
B 795	BURIAL	N.C.	U/L 761 O/L 796	OH		3		ADULT BURIAL
B 796	BURIAL	N.C.	U/L 795	OH		3		ADULT BURIAL
797	STRUCT	S.C.				6		DRAIN
B 798	BURIAL	S.C.	O/L 790			6		Adult
799	STRUCT	"				"		BRICK GRAVE
X 800	BURIAL	"	U/L 798			"		ZINC LEAD COFFIN
X 801	BURIAL	"	O/L 802			"		LEAD COFFIN
B 802	"	"	U/L 801			"		Adult
B 803	"	"	O/L 804 O/L 800			"		
B 804	"	"	O/L 805 U/L 803			"		
B 805	"	"	U/L 804			"		
B 806	"	"				"		"
B 807	"	"	O/L 808			"		LEAD Adult
B 808	"	"	U/L 809			"		"
B 809	"	"	U/L 808			"		Adult
B 810	"	"	O/L 815			"		"
B 811	"	"	O/L 812			"		"
B 812	"	"	U/L 813 U/L 811			"		"
B 813	"	"	U/L 812 U/L 814			"		"
B 814	"	"	U/L 813			"		"
B 815	"	"	U/L 810			"		"
B 816	"	"	U/L 814			"		BABY
B 817	"	"	O/L 820			"		Adult
B 818	"	"	O/L VAULT			"		"
B 819	"	"				"		LEAD ADULT WITH STONES
B 820	"	"	U/L 817 O/L 821			"		Adult
B 821	"	"	U/L 820 O/L 822			"		LEAD Adult
B 822	"	"	U/L 821 U/L 823			"		"
B 823	"	"	U/L 822 U/L 824			"		"
B 824	"	"	U/L 823			"		Adult
B 825	"	"	O/L 826			63		ADULT
B 826	"	"	O/L 825			63		ADULT
B 827	"	"	O/L 861			63		ADULT (woman)

BURIALS THIS SHEET = 31



SITE		CONTEXT				SITE ST. LUKES CHURCH,		
CODE: OLROO		CHECKLIST				NAME: ISLINGTON		
Context No.	Type	Excavated with Segments	Relationships	Dug	Drawn		Matrix NAME	Comments
					Section	Plan		
B/DNA 861	BURIAL	S.C.	U/L 827 OIL 862	BH/OPM	/	6	Y	LEAD COFFIN
B/DNA 862	BURIAL	u	U/L 862 OIL 863	u	/	6	Y	LEAD COFFIN
B 863	BURIAL		<del>U/L 862</del> OIL 864		/		N	ADULT BURIAL
B 864	BURIAL		U/L 863 OIL 865		/		Y	LEAD COFFIN - ILLUS. PLATE
B 865	BURIAL		U/L 864 OIL 866		/		N	ADULT BURIAL
B 866	BURIAL		U/L 865		/		N	ADULT BURIAL
B 867	"		WITHIN VAULT 125		/		N	ADULT - Lead
B/DNA 868	u	S.C.	WITHIN V. 124	OPM	/	6	Y	ADULT - Pb
B/DNA 869	u	"	"	OPM	/	6	Y	ADULT - Pb
B 870	u	u	u	OPM	/	6	N	ADULT - Pb
B 871	u	u	OIL 872 Truncates 872	OPM	/	6	N	ADULT BURIAL
B 872	u	u	U/L 871 Truncated by 871	OPM	/	6	N	ADULT BURIAL
B 873	u	u		OPM	/	6	N	u
B 874	u	u	OIL 871	OPM	/	6	N	INFANT BURIAL
B 875	u	u	U/L 874	OPM	/	6	N	ADULT BURIAL
B 876	u	u	<del>U/L 874</del>	OPM	/	6	N	u
B 877	u	u	<del>U/L 874</del>	OPM	/	6	N	u
B 878	u	u	OIL 879	OPM	/	6	N	u
B 879	u	u	U/L 878	OPM	/	6	N	u
B 880	u	u	OIL 881	OPM	/	6	N	u
B 881	u	u	U/L 880 OIL 882	OPM	/	6	N	INFANT BURIAL
B 882	u	u	U/L 881 OIL 883	OPM	/	6	N	ADULT BURIAL
B 883	u	u	U/L 882	OPM	/	6	N	u
B 884	u	u	O/L 885	B/DH	/	6	N	u
B 885	u	u	U/L 884	B/DH	/	6	N	u
B 886	u	u	U/L 885	B/DH	/	6	N	u
B 887	u	u	U/L 883	T/S DH	/	6	N	ADOLESCENT BURIAL
B 888	u	u	O/L-889	DM	/	6	N	ADULT BURIAL
B 889	u	u	U/L 888	DM	/	6	N	u
B/DNA 890	u	u	O/L 891	DM	/	6	Y	Pb COFFIN - NAMED
B 891	u	u	<del>O/L 891</del> U/L 890	DM	/	6	N	Pb COFFIN - UNNAMED
B 892	u	u	OIL 929	OPM	/	6	N	ADULT BURIAL
B 893	u	u	U/L 891	OPM	/	6	N	Pb COFFIN - UNNAMED

db

SITE #	COFFIN RECORD SHEET	CONTEXT NO.
DLR00		762
Trench:	Additional sheets: YES X2	Treatment:
Site sub-div: CLUPT, BAU1 NAVET 240	Grave fills	→ NonKoyou
Plan no: 7	Grave cut:	Finds None
Section no:	Skeleton:	Breastplate ✓ Grip
Co-ordinates:	Matrix location: 925 926 929 928  762 763 764	Hinge Bracket
Levels	Preservation: GOOD	Fixing nails Shroud pins
Slide No.	Neg No:	Fabric Other finds:

**Description** E-W ADULT BURIAL. Pb LINED COFFIN, SOLDERED TOP & BATE. BREASTPLATE PROJEKT, COFFIN I.D. OF BREAST OF Pb COFFIN - SOLDERED TO COFFIN TOP. WOOD PROJEKT AROUND COFFIN.

**Discussion**

Shape, dimensions and distinguishing characteristics

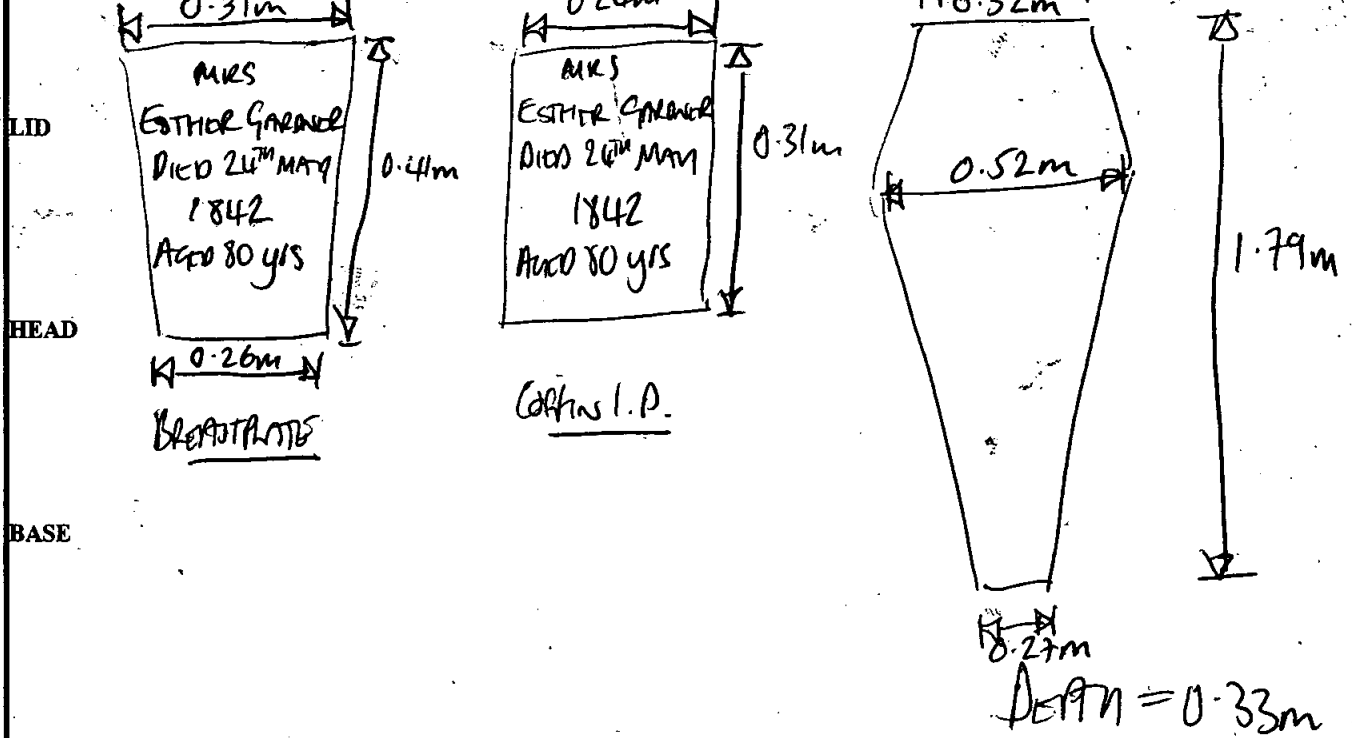

Recorder: BRM	Date: 17/10/00	Initials:
---------------	----------------	-----------

**Outer Coffin**

Sample Ret.

Site Code

04R00

Context

762

Recording Date ..... 20/10 .....

Associated Numbers .....

Condition .....

Dep. Plate

Legible

Inscription "Mrs/Ester Gardner/ Died 24<sup>th</sup> May/ 1842/ Aged 80 yrs"

Fabric lead  ormolou  brass  tin plated pewter  gilt tin   
iron  silvered tin  enamelled  other ..... Sample Ret.

**Shape of dep. plate**

square  rectangle  shield  tapered  lozenge   
cartouche  oval  other .....

**Upholstery**

colour ..... shoddy  velvet  other ..... Sample Ret.

**Construction**

butt joint  mitred  pitched  other .....

Grip plate  Fabric = ormolou  brass  tin plated pewter  gilt tin   
iron  silvered tin  enamelled  other ..... Sample Ret.

Grip  Fabric = ormolou  brass  iron  Sample Ret.

Design swag of rose  horseshoe  cherub's head  plain   
other .....

Grip bolts  Corner bolts  Type = gilt brass  brass  iron   
other ..... Sample Ret.

Lid motifs  other ..... Sample Ret.

Escutcheons  other ..... Sample Ret.

Upholstery nails  brass  gilt brass  silvered brass  iron  enamelled   
other ..... Sample Ret.

Fixings  panel nails  screws  hinges  lace  Sample Ret.

Timber type ..... Sample Ret.

**Interpretation / Comments**

.....  
.....

db

SITE OLR00	COFFIN RECORD SHEET	CONTEXT NO. 763
Trench:	Additional sheets: YES X1	Treatment: NOT NEAR BONES/DNA CONNECTED.
Site sub-div: CRUPT BAY VAULT 240	Grave fills	Finds None
Plan no: 7	Grave cut:	Breastplate ✓ Grip ✓
Section no:	Skeleton:	Hinge Bracket
Co-ordinates:	Matrix location: 725 726 727 728 762 763 764	Fixing nails Shroud pins
Levels	Preservation:	Fabric Other finds
Slide No.	Neg No:	

Description W-E INHAST BURIAL Pb coffin soldered top & base. BREASTPLATE, COFFIN I.D. PLATE SOLIDIFIED TO FRONT OF COFFIN. WOODEN CASK COFFIN REMAINS PRESENT.

Discussion

Shape, dimensions and distinguishing characteristics

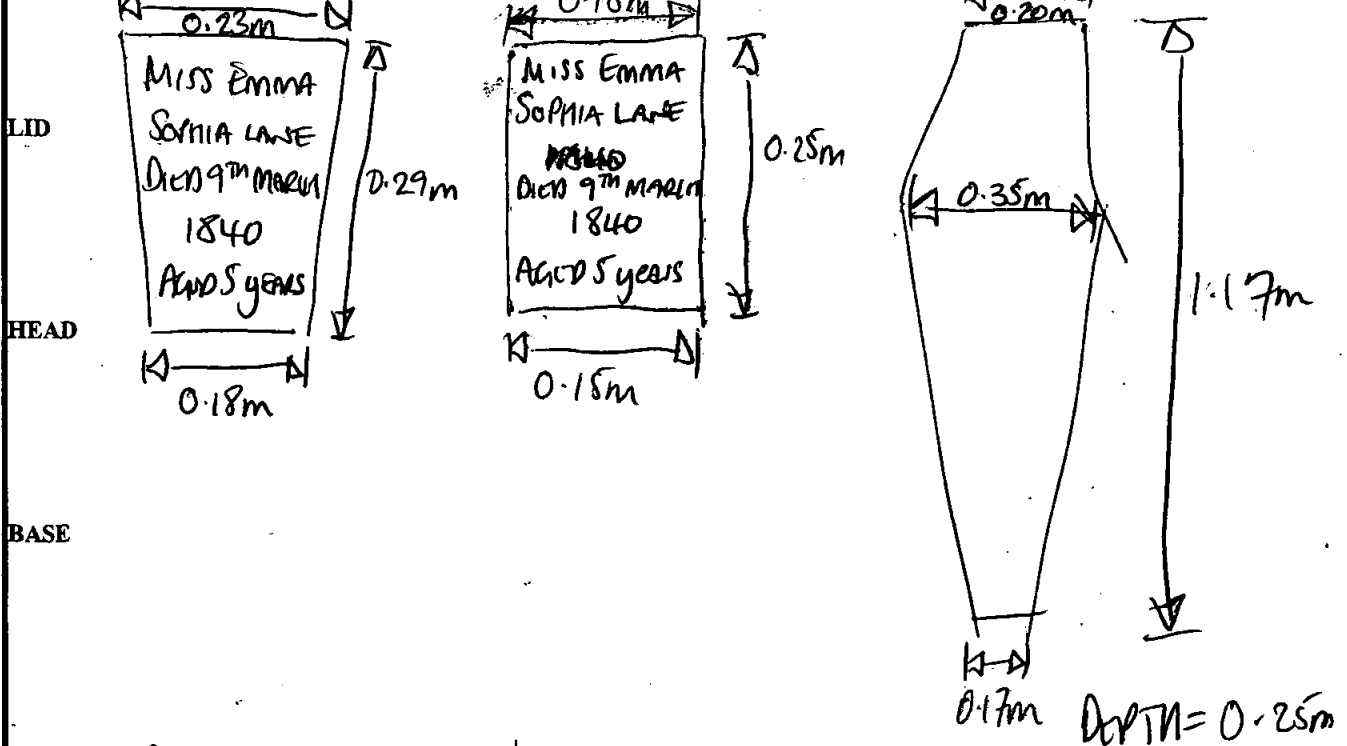

Recorder: [Signature]	Date: 17/10/00	Initials:
-----------------------	----------------	-----------



# Coffin Recording Sheet

Site Code

Context

OLR00

763

**Outer Coffin**

Sample Ret.

Recording Date ..... 20/10 .....

Associated Numbers .....

Condition ..... 2 .....

Dep. Plate

Legible

0.23 x 0.19 x 0.28

Inscription "Miss Emma / Sophia home / Died 9<sup>th</sup> March / 1840 /  
Aged 5 years"

Fabric lead  ormolou  brass  tin plated pewter  gilt tin   
iron  silvered tin  enamelled  other ..... Sample Ret.

**Shape of dep. plate**

square  rectangle  shield  tapered  lozenge   
cartouche  oval  other ..... *(21) w/ diff inner border & plain outer border.*

**Upholstery**

colour ..... shoddy  velvet  other ..... Sample Ret.

**Construction**

butt joint  mitred  pitched  other .....

**Grip plate**

Fabric = ormolou  brass  tin plated pewter  gilt tin   
*Flaps on Rev. of grip* iron  silvered tin  enamelled  other ..... Sample Ret.

**Grip**

Fabric = ormolou  brass  iron  Sample Ret.

**Design**

swag of rose  horseshoe  cherub's head  plain

other ..... *1 x small Ⓣ ← = 0.12 ↑ = 0.055*

**Grip bolts**

**Corner bolts**  Type = gilt brass  brass  iron

other ..... Sample Ret.

**Lid motifs**

other ..... Sample Ret.

**Escutcheons**

other ..... Sample Ret.

**Upholstery nails**

brass  gilt brass  silvered brass  iron  enamelled

other ..... Sample Ret.

**Fixings**

panel nails  screws  hinges  lace  Sample Ret.

**Timber type** .....

Sample Ret.

**Interpretation / Comments**

.....  
.....

db

SITE	COFFIN RECORD SHEET	CONTEXT NO.
OLR00		764
Trench:	Additional sheets: YES x1	Treatment:
Site sub-div: CUMT, DM1 VAULT 240	Grave fills	BONES/DMT COVERED
Plan no: 7	Grave cut:	Finds None
Section no:	Skeleton: GOOD	Breastplate <input checked="" type="checkbox"/> Grip <input checked="" type="checkbox"/>
Co-ordinates:	Matrix location: 925 926 927 928 762 763 764	Hinge Bracket
Levels	Preservation: Poor.	Fixing nails Shroud pins
Slide No.	Neg No:	Fabric Other finds

**Description** E-W ADULT BURIAL. P.D LINED COFFIN SECLUDED TOP & BOT. BREASTPLATE EMBOSSED, I.D. PLATE ON BREAST OF COFFIN. UNKNOWN OUTER COFFIN REMS PRESENT. POSSIBLY SURROUNDED - SMALL PLATES OF MATERIAL ON EITHER OF COFFIN

**Discussion**

Shape, dimensions and distinguishing characteristics

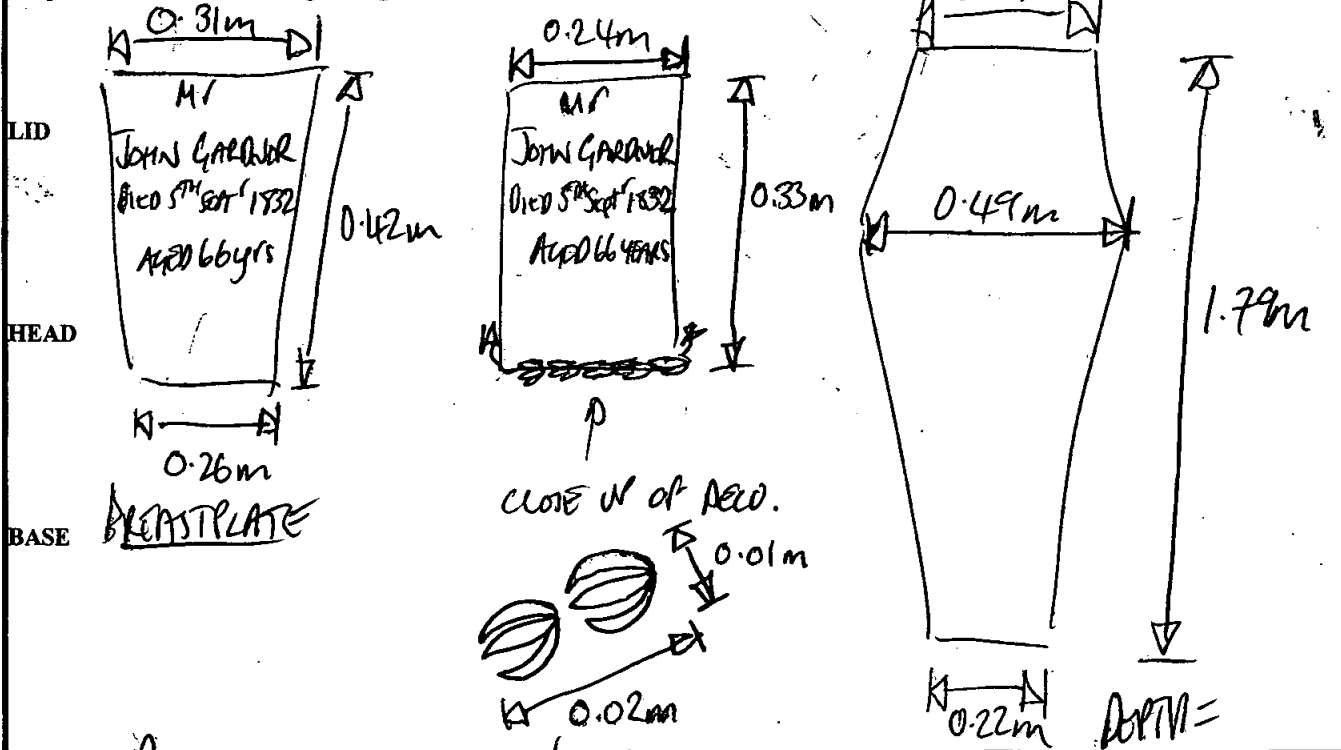

Recorder: *KPM* Date: 19/10/00 Initials:

# Coffin Recording Sheet

Site Code

Context

0400

764

**Outer Coffin**

Sample Ret.

Recording Date ..... 25/10 .....

Associated Numbers .....

Condition ..... 3 .....

Dep. Plate

Legible

Inscription "Mr/John Gardner/Died 5<sup>th</sup> Sept<sup>s</sup> 1832/Aged 66 Years"

Fabric lead  ormolou  brass  tin plated pewter  gilt tin   
 iron  silvered tin  enamelled  other ..... Sample Ret.

**Shape of dep. plate**

square  rectangle  shield  tapered  lozenge   
 cartouche  oval  other ..... *(21) w/ diff. outer boarder which is 534. (inner boarder same).*

**Upholstery**

colour ..... shoddy  velvet  other ..... Sample Ret.

**Construction**

butt joint  mitred  pitched  other .....

Grip plate  Fabric = ormolou  brass  tin plated pewter  gilt tin   
 iron  silvered tin  enamelled  other ..... Sample Ret.

Grip  Fabric = ormolou  brass  iron  X1 Sample Ret.

Design swag of rose  horseshoe  cherub's head  A plain   
 other .....

Grip bolts  Corner bolts  Type = gilt brass  brass  iron   
 other ..... Sample Ret.

Lid motifs  other ..... Sample Ret.

Escutcheons  other ..... Sample Ret.

Upholstery nails  brass  gilt brass  silvered brass  iron  enamelled   
 other ..... Sample Ret.

Fixings  panel nails  screws  hinges  lace  Sample Ret.

Timber type ..... Sample Ret.

**Interpretation / Comments**

.....  
 .....

db

SITE <u>OLR 001</u>		COFFIN RECORD SHEET	CONTEXT NO. <u>765</u>
Trench:	Additional sheets:	Treatment:	
Site sub-div: <u>CRUPT, BM 3</u>	Grave fills	<u>A Necropolis</u>	
Plan no: <u>7</u>	Grave cut:	Finds	
Section no:	Skeleton:	None	
Co-ordinates:	Matrix location: <u>(359)</u> <u>(765)</u>	Breastplate	
Levels	Preservation: <u>Poor</u>	Grip	
Slide No.	Neg No:	Hinge	
		Bracket	
		Fixing nails	
		Shroud pins	
		Fabric	
		Other finds	

Description W → E ADULT BURIAL. SOLIDWOOD TOP & RISE WITH (EMBEDDED) COFFIN I.D. AT BREAST OF COFFIN

Discussion

Shape, dimensions and distinguishing characteristics

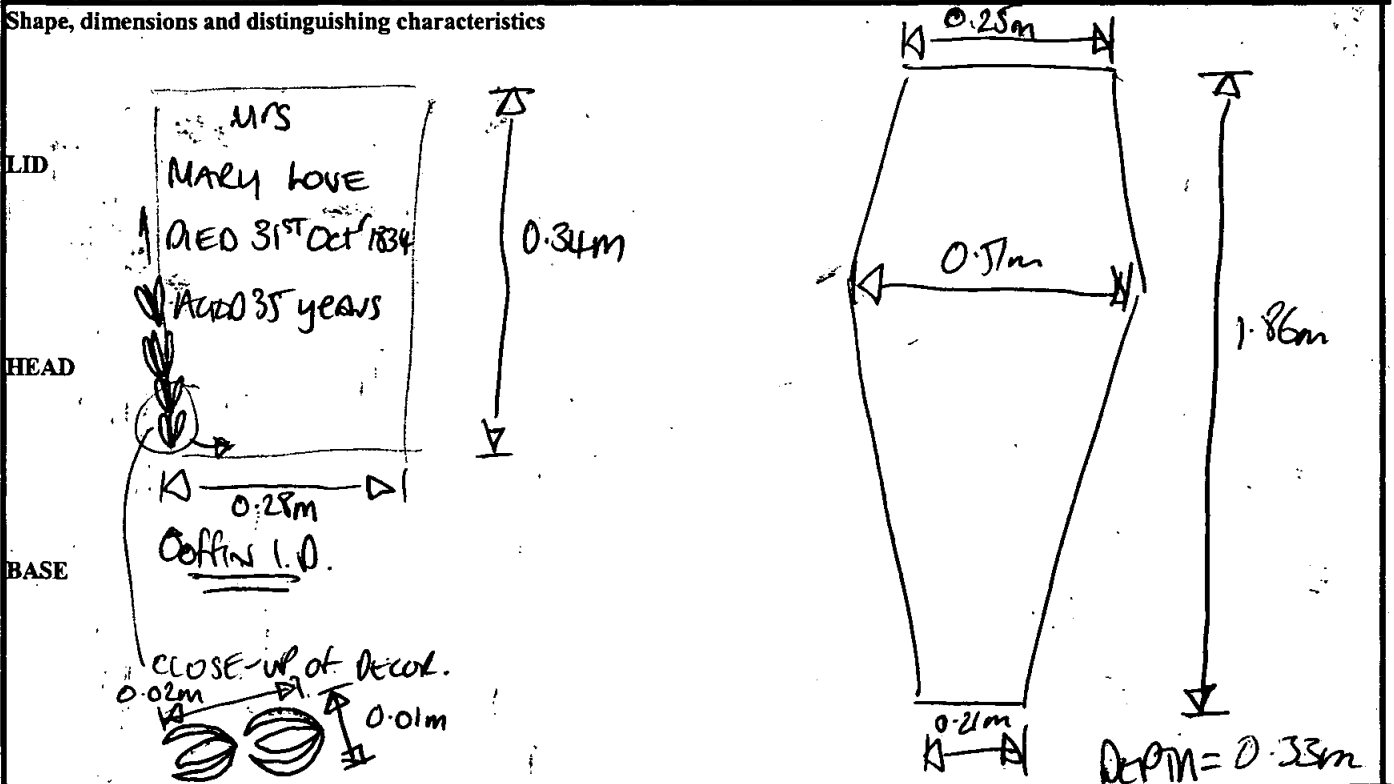

Recorder: JAM Date: 20/10/00 Initials:

db

SITE	COFFIN RECORD SHEET	CONTEXT NO.
OLR00		766
Trench:	Additional sheets:	Treatment:
Site sub-div: CUMPT, BAN 3	Grave fills	BONES COMPLETED.
Plan no: 7	Grave cut:	Finds None
Section no:	Skeleton: Pool	Breastplate Grip
Co-ordinates:	Matrix location: (359) (766)	Hinge Bracket
Levels	Preservation: Poor	Fixing nails Shroud pins
Slide No.	Neg No:	Fabric Other finds

**Description** E-W ADULT BURIAL. Pb COFFIN SOLID TOP & BASE. COFFIN I.D. PLATE MISSING FROM SOLDING POINTS. NO SIGN OF WOOD AROUND COFFIN. COFFIN MAY HAVE BEEN COMPRESSED BY GRAVE ROBBING - HOLE IN VAULT CEILING ABOVE.

**Discussion**

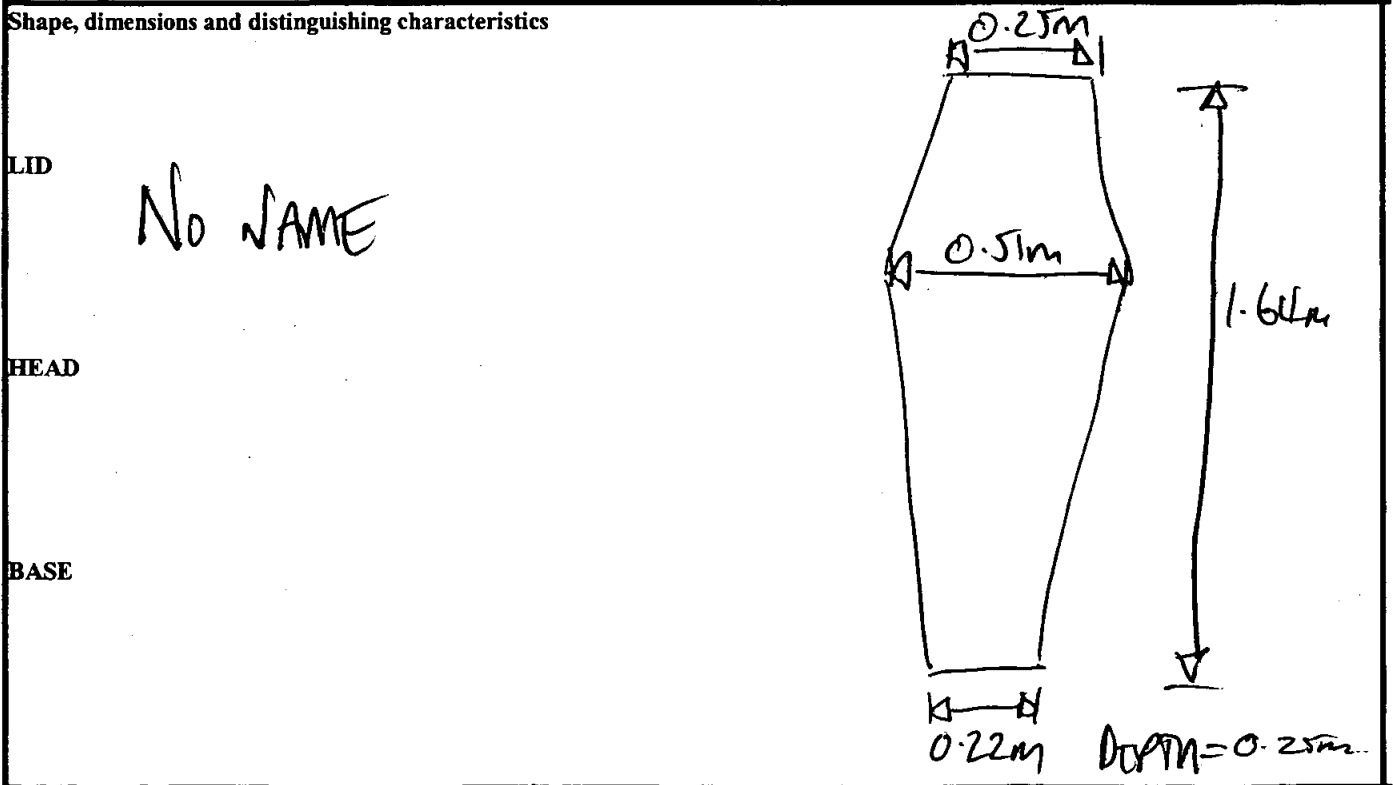

Recorder: [Signature]	Date: 20/10/00	Initials:
-----------------------	----------------	-----------

SITE	COFFIN RECORD SHEET	CONTEXT NO.
OLK00		767
Trench:	Additional sheets:	Treatment:
Site sub-div: <i>CHURCH, BM3</i>	Grave fills	<i>BONES CONCRETE</i>
Plan no:	Grave cut:	Finds
<i>7</i>		None
Section no:	Skeleton: <i>V. POOR NO OVA'BLE REMS</i>	Breastplate
		Grip <input checked="" type="checkbox"/>
Co-ordinates:	Matrix location:	Hinge
	<i>(767)</i>	Bracket
Levels	Preservation: <i>ACID</i>	Fixing nails
		Shroud pins
Slide No.	Neg No:	Fabric
		Other finds

Description *E-W ADULT BURIAL. Pb COFFIN SOLDERED TOP & BASE SIGNS OF WATER WEAR WERE ASSOCIATED WITH COFFIN. 'DIAMOND' I.D. PLATE SOLDERED AND PINNED TO CHEST OF Pb COFFIN. COFFIN CONTAINED REMS. BY GILNE ROBBERY - BURIAL IN VULCANITE CEILING ABOVE. BEANS PULLED CORNS,*

Discussion *V. LITTLE SKELETAL REMS.*

Shape, dimensions and distinguishing characteristics

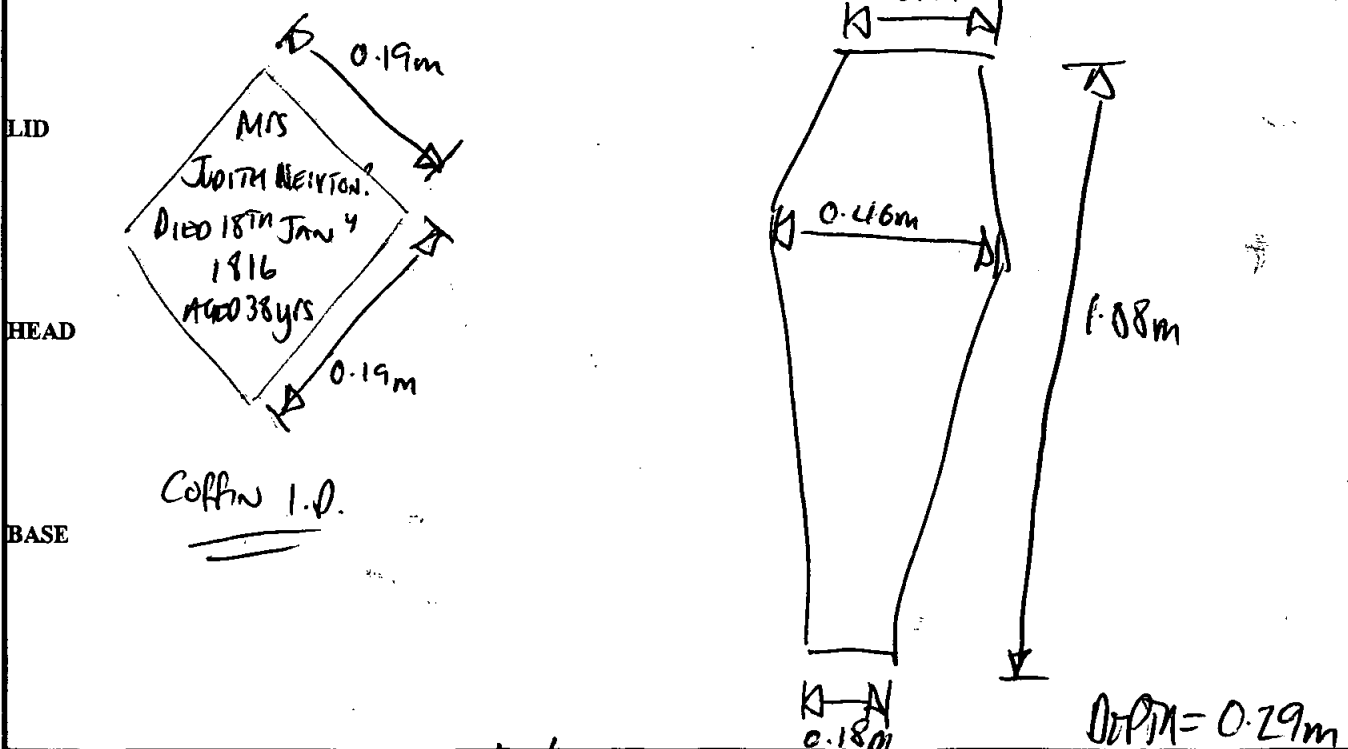

Recorder: <i>DM</i>	Date: <i>20/10/00</i>	Initials:
---------------------	-----------------------	-----------

db

SITE OLR 00	COFFIN RECORD SHEET	CONTEXT NO. 768
Trench:	Additional sheets:	Treatment: bones covered
Site sub-div: crypt, BM 3	Grave fills	
Plan no: 7	Grave cut:	Findings None
Section no:	Skeleton: Good	Breastplate Grip
Co-ordinates:	Matrix location: 768	Hinge Bracket
Levels	Preservation: Good / corrosion at base	Fixing nails Shroud pins
Slide No.	Neg No:	Fabric Other finds

**Description** W-E ADULT BURIAL. Pb COFFIN SOLDERED TOP & BASE  
SOLDERED COFFIN I.D. PLATE MISSING - NO NAME. COFFIN COMPRESSED  
BY GRAVE-ROBBING? BREATH IN CRYPT CEILING AREA.

**Discussion**

Shape, dimensions and distinguishing characteristics

LID NO NAME

HEAD

BASE

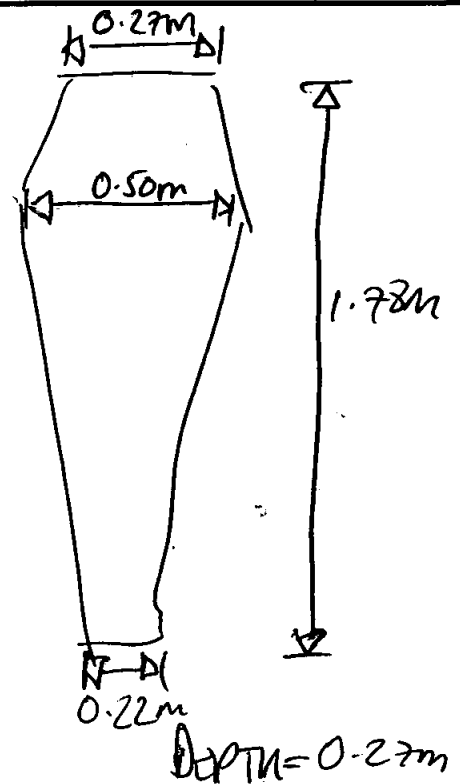

Recorder: DM	Date: 20/10/00	Initials:
--------------	----------------	-----------

db

SITE <b>OL00</b>	COFFIN RECORD SHEET	CONTEXT NO. <b>769</b>
Trench:	Additional sheets:	Treatment: <b>NECROPHOUS</b>
Site sub-div: <b>OL01, L013</b>	Grave fills	Finds None
Plan no: <b>7</b>	Grave cut:	Breastplate Grip
Section no:	Skeleton: <b>352</b>	Hinge Bracket
Co-ordinates:	Matrix location: <b>769</b>	Fixing nails Shroud pins
Levels	Preservation:	Fabric Other finds
Slide No.	Neg No:	

**Description** E & W ADULT BURIAL. NO COFFIN, SANDWICH TOP & BOTTOM SIGNS OF OUTER COFFIN WOOD PRESENT. EMBOSSED I.D. ON BROAD OF COFFIN & HEAD-PLATE PRESENT, PINNED TO OUTER WOOD.

**Discussion**

**Shape, dimensions and distinguishing characteristics**

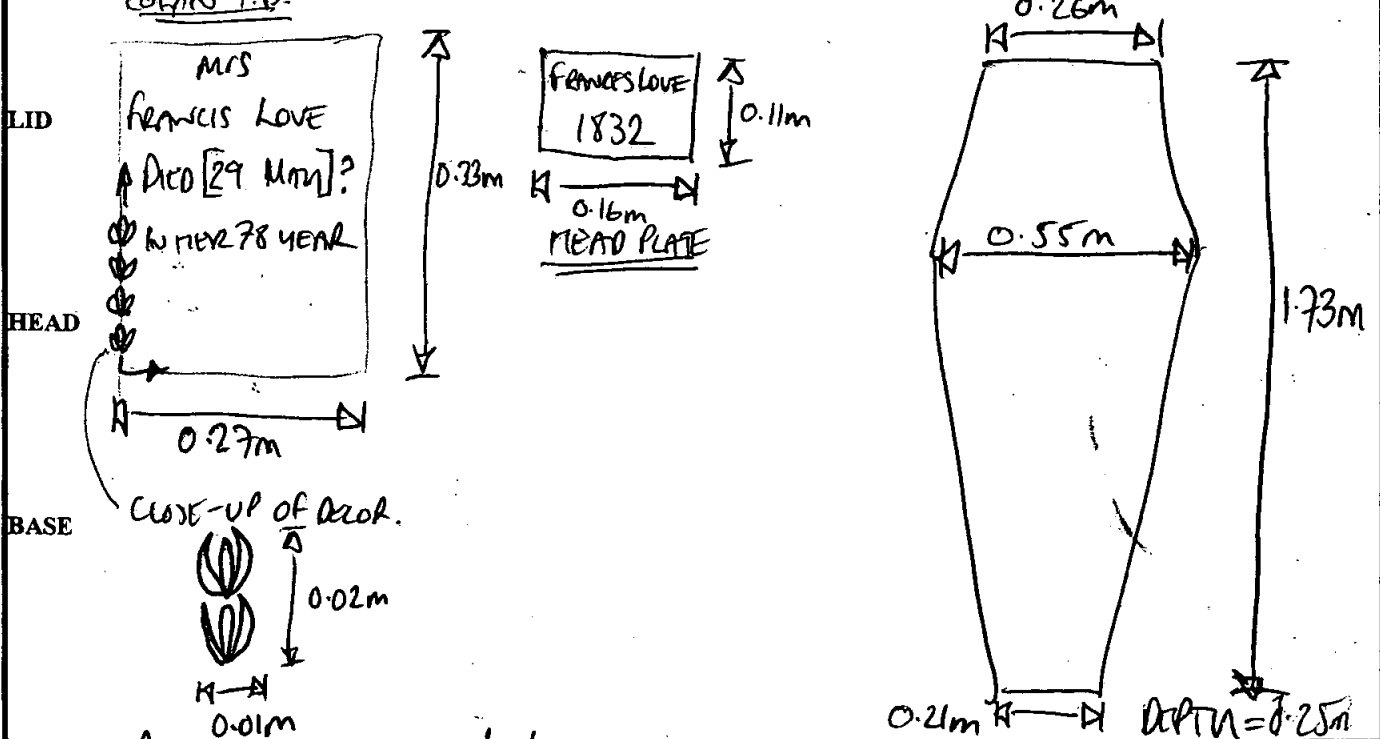

Recorder: <b>JRM</b>	Date: <b>20/10/00</b>	Initials:
----------------------	-----------------------	-----------



db

SITE	COFFIN RECORD SHEET	CONTEXT NO.
02.00		770
Trench:	Additional sheets:	Treatment:
Site sub-div: <u>COUNT, ERM 2</u> <u>Vault 25</u>	Grave fills	→ Necropolis
Plan no: 7	Grave cut:	Finds None
Section no:	Skeleton: ✓	Breastplate ✓ Grip
Co-ordinates:	Matrix location: <u>770</u>	Hinge Bracket
Levels	Preservation: <u>GOOD</u>	Fixing nails Shroud pins
Slide No.	Neg No:	Fabric Other finds

**Description** E-W ADULT BURIAL WITHIN VAULT 25. Pb coffin soldered top & base, wood rem of outer coffin present & breastplate and soldered coffin ID plate present. Breastplate pinned to outer wooden coffin. Coffin ID says: "IN HER 43<sup>rd</sup> YEAR", breastplate states "IN HER 42<sup>nd</sup> YEAR"? NOT A RECORDING MISTAKE.

**Discussion**

Shape, dimensions and distinguishing characteristics

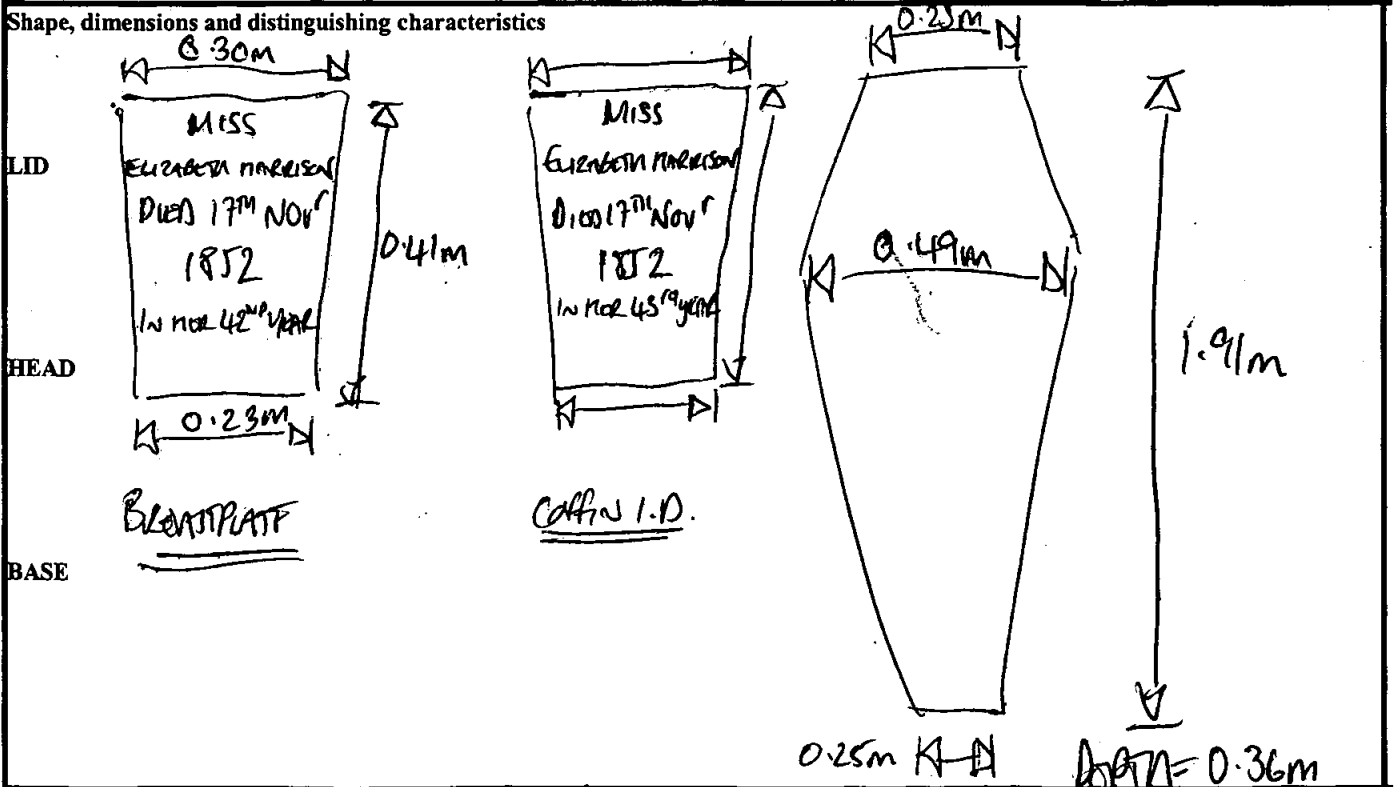

Recorder: [Signature] Date: 20/10/00 Initials:

# Coffin Recording Sheet

Site Code

Context

OKR00

770

**Outer Coffin**

Sample Ret.

Recording Date ..... 20/10 .....

Associated Numbers .....

Condition ..... 4 .....

Dep. Plate

Legible

Inscription " MISS/ELIZABETH HARRISON/DIED 17<sup>TH</sup> NOV/1852/In her 42<sup>nd</sup> Year "

Fabric lead  ormolou  brass  tin plated pewter  gilt tin   
 iron  silvered tin  enamelled  other ..... Sample Ret.   
*Some as 771*

**Shape of dep. plate**

square  rectangle  shield  tapered  lozenge   
 cartouche  oval  other .....

**Upholstery**

colour ..... shoddy  velvet  other ..... Sample Ret.

**Construction**

butt joint  mitred  pitched  other .....

Grip plate  Fabric = ormolou  brass  tin plated pewter  gilt tin   
 iron  silvered tin  enamelled  other ..... Sample Ret.

Grip  Fabric = ormolou  brass  iron  Sample Ret.   
*Some as 771*

Design swag of rose  horseshoe  cherub's head  plain   
 other .....

Grip bolts  Corner bolts  Type = gilt brass  brass  iron   
 other ..... Sample Ret.

Lid motifs  other .....

Escutcheons  other .....

Upholstery nails  brass  gilt brass  silvered brass  iron  enamelled   
 other ..... Sample Ret.

Fixings  panel nails  screws  hinges  lace  Sample Ret.

Timber type ..... Sample Ret.

**Interpretation / Comments**

.....  
 .....

db

SITE	COFFIN RECORD SHEET	CONTEXT NO.
OLKROO		771
Trench:	Additional sheets:	Treatment: Bone/ DNA collected
Site sub-div: CHURCH, BAME VAULT 25	Grave fills	<del>WOOD REMAINS</del>
Plan no: 7	Grave cut:	Finds
Section no:	Skeleton: GOOD.	None
Co-ordinates:	Matrix location: (771)	Breastplate ✓
Levels	Preservation: GOOD	Grip ✓
Slide No.	Neg No:	Hinge
		Bracket
		Fixing nails
		Shroud pins
		Fabric
		Other finds

**Description** E-W ADULT BURIAL. NO COFFIN <sup>PINNED</sup> ~~REMOVED~~ TOP & BASE, WITH SOLIDIFIED I.O. RAISED BEHIND OF COFFIN, AND PINNED BREASTPLATE ON A SIDE WOOD REMAINS. BRANNED CONTENTS.

**Discussion**

Shape, dimensions and distinguishing characteristics

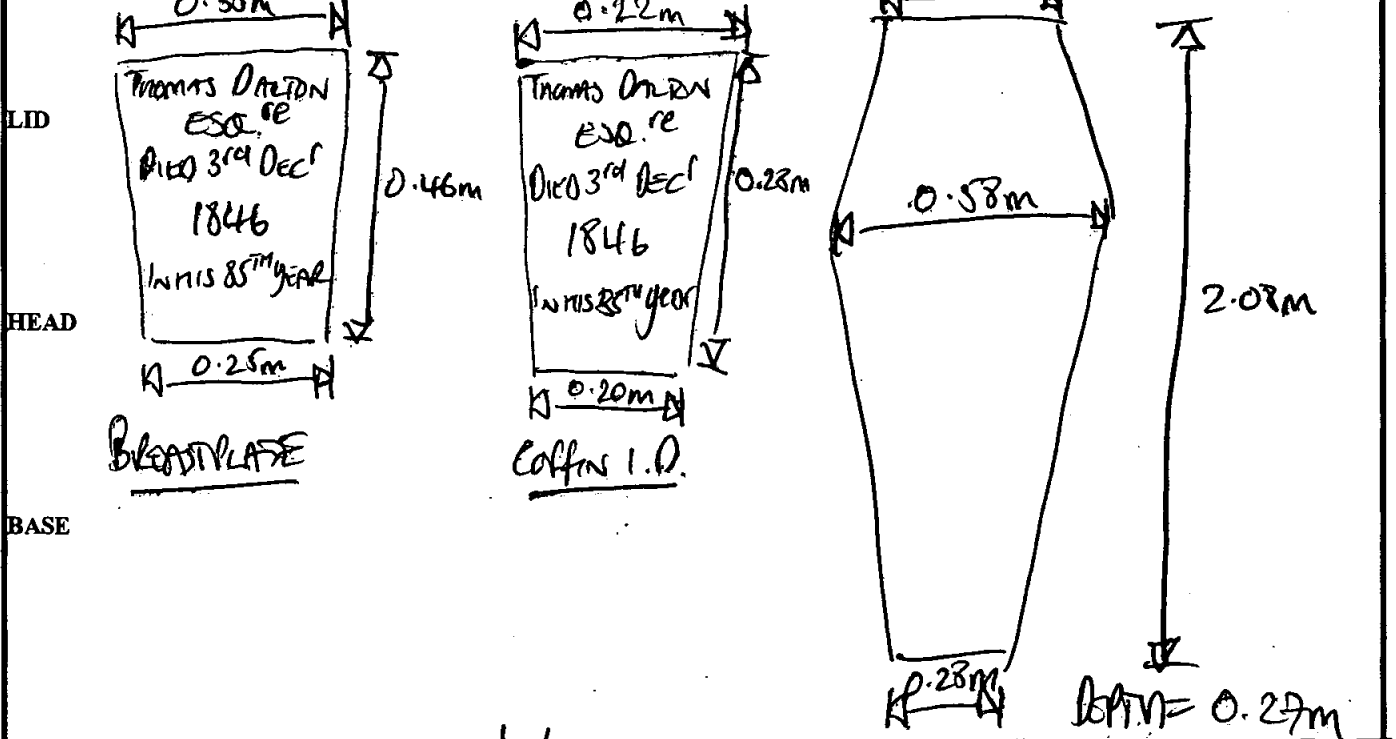

Recorder: *DM* Date: 20/10/00 Initials:

# Coffin Recording Sheet

Site Code

Context

**Outer Coffin**

Sample Ret.

OLR00

771  
~~771~~

Recording Date ..... 20/10 .....

Associated Numbers .....

Condition ..... A .....

Dep. Plate

Legible

Inscription "Thomas Dalton / Esq.<sup>re</sup> / DIED 3<sup>RD</sup> DEC<sup>R</sup> / 1846 / In his 65<sup>th</sup> year"

Fabric lead  ormolou  brass  tin plated pewter  gilt tin   
 iron  silvered tin  enamelled  other ..... Sample Ret.

**Shape of dep. plate**

square  rectangle  shield  tapered  lozenge   
 cartouche  oval  other ..... *(20) w/ husk flower band instead of plain band. see following sheet for detail*

**Upholstery**

colour ..... shoddy  velvet  other *Boize* ..... Sample Ret.

**Construction**

butt joint  mitred  pitched  other .....

Grip plate  Fabric = ormolou  brass  tin plated pewter  gilt tin   
 iron  silvered tin  enamelled  other ..... Sample Ret.

Grip  Fabric = ormolou  brass  iron  Sample Ret.

Design swag of rose  horseshoe  cherub's head  plain   
 other ..... *large 228a w/ Fe. ball terminals*  
*← = 0.21 ↑ = 0.07.*

Grip bolts  Corner bolts  Type = gilt brass  brass  iron

other ..... Sample Ret.

Lid motifs  other ..... Sample Ret.

Escutcheons  other ..... Sample Ret.

Upholstery nails  brass  gilt brass  silvered brass  iron  enamelled

other ..... Sample Ret.

Fixings  panel nails  screws  hinges  lace  Sample Ret.

Timber type ..... Sample Ret.

**Interpretation / Comments**

.....  
 .....

db

SITE <b>OLR00</b>	COFFIN RECORD SHEET	CONTEXT NO. <b>772</b>
Trench:	Additional sheets:	Treatment: <b>BONE/ONA CONCRETE</b>
Site sub-div: <b>CAMP, BAY 3</b>	Grave fills	
Plan no: <b>7</b>	Grave cut:	Finds None
Section no:	Skeleton: <b>VERY POOR - STAGNANT</b>	Breastplate Grip
Co-ordinates:	Matrix location: <b>(772)</b>	Hinge Bracket
Levels	Preservation: <b>SAD</b>	Fixing nails Shroud pins
Slide No.	Neg No:	Fabric Other finds

**Description** N-DE ADULT BURIAL. Pb coffin, separated TOP & BASE, SLOTTED COFFIN I.D. PLATE ON BREAST OF COFFIN, TRACES OF COFFIN WELD PRESENT.

**Discussion**

**Shape, dimensions and distinguishing characteristics**

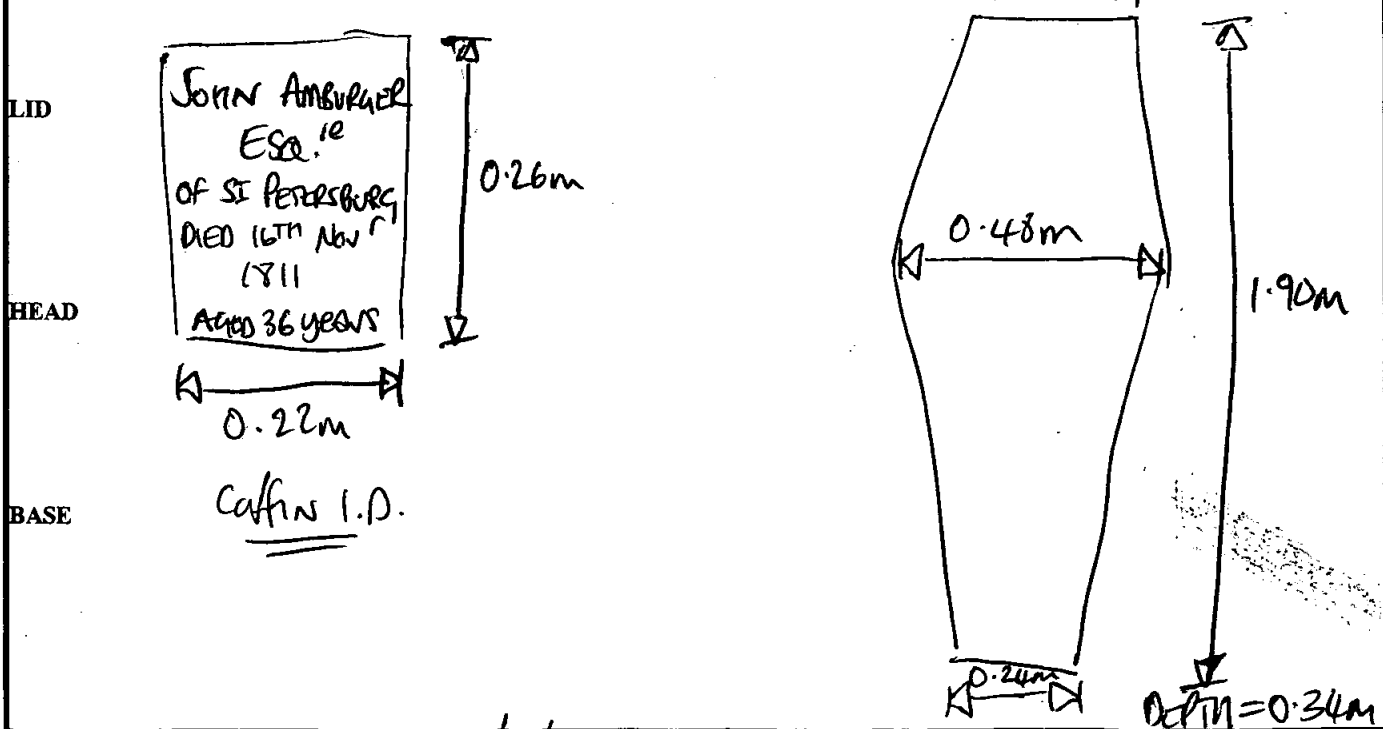

Recorder: <b>DBM</b>	Date: <b>20/10/00</b>	Initials:
----------------------	-----------------------	-----------

db

SITE OLROO	COFFIN RECORD SHEET	CONTEXT NO. 773
Trench:	Additional sheets:	Treatment:
Site sub-div: CUYA, BAMB	Grave fills	<del>→</del> Necropolis
Plan no: 7	Grave cut:	Finds None
Section no:	Skeleton: ✓	Breastplate Grip
Co-ordinates:	Matrix location: 773	Hinge Bracket
Levels	Preservation: EXCELLENT.	Fixing nails Shroud pins
Slide No.	Neg No:	Fabric Other finds

**Description** W + E ADULT BURIAL - Pb coffin (EXCELLENT CONSTRUCTION, LARGE FLARED SIDERS, STILL FULLY INTACT.) SOLDERED TOP & BASE, COFFIN I.P. SOLDERED TO MOUNT OF COFFIN.

**Discussion**

**Shape, dimensions and distinguishing characteristics**

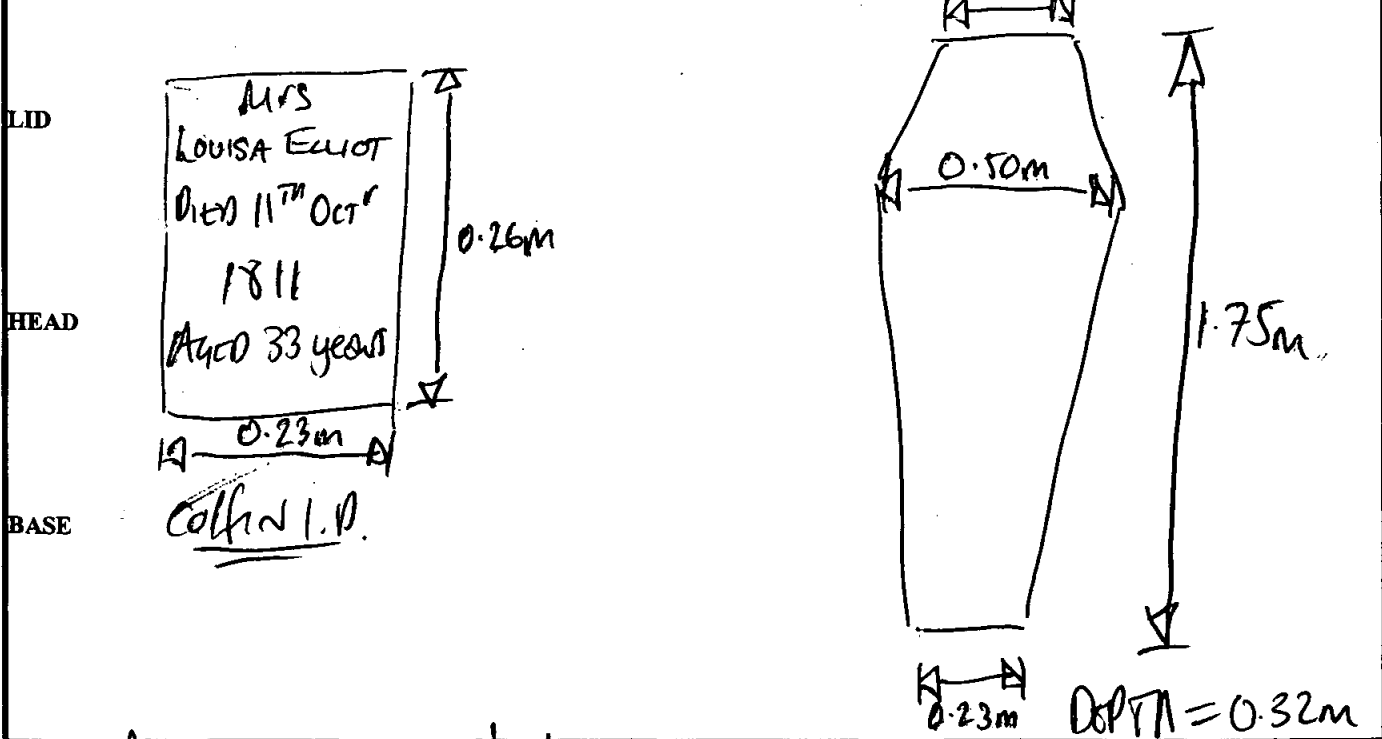

Recorder: <i>AM</i>	Date: 20/10/00	Initials:
---------------------	----------------	-----------

db

SITE ALR00	COFFIN RECORD SHEET	CONTEXT NO. 774
Trench:	Additional sheets:	Treatment: bare covered
Site sub-div: CH4TT, BMS	Grave fills	
Plan no: 7	Grave cut:	Finds None
Section no:	Skeleton: G00M.	Breastplate Grip
Co-ordinates:	Matrix location: 774	Hinge Bracket
Levels	Preservation: Average	Fixing nails Shroud pins
Slide No.	Neg No:	Fabric Other finds

Description W-E ADULT BURIAL. Pb coffin supported N/S & E/W. SOME SIGNS OF CORROSION VISIBLE. NO I.P.

Discussion

Shape, dimensions and distinguishing characteristics

LID

NO NAME

HEAD

BASE

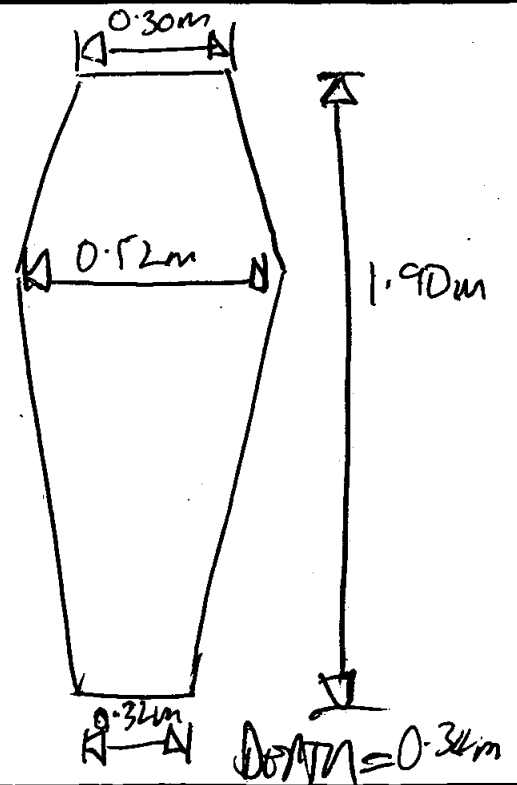

Recorder: BM	Date: 20/10/00	Initials:
--------------	----------------	-----------

db

SITE OLROO		COFFIN RECORD SHEET	CONTEXT NO. 775
Trench:	Additional sheets:	Treatment: BONE/DNA COURSED	
Site sub-div: CAUPT, BMZ	Grave fills		
Plan no: 7	Grave cut:	Finds None	
Section no:	Skeleton: GOOD (CANTH) POOR (UPPER-COFFIN COURSE)	Breastplate Grip	
Co-ordinates:	Matrix location: (775)	Hinge Bracket	
Levels	Preservation: POOR	Fixing nails Shroud pins	
Slide No.	Neg No:	Fabric Other finds	

**Description** W-E ADULT BURIAL. NO COFFIN PINNED TOP & BASE. WARE COFFIN. SOLDERED LEAD I.O. PLATE ON COFFIN BREAST. BROWN FINED COFFIN.

**Discussion**

**Shape, dimensions and distinguishing characteristics**

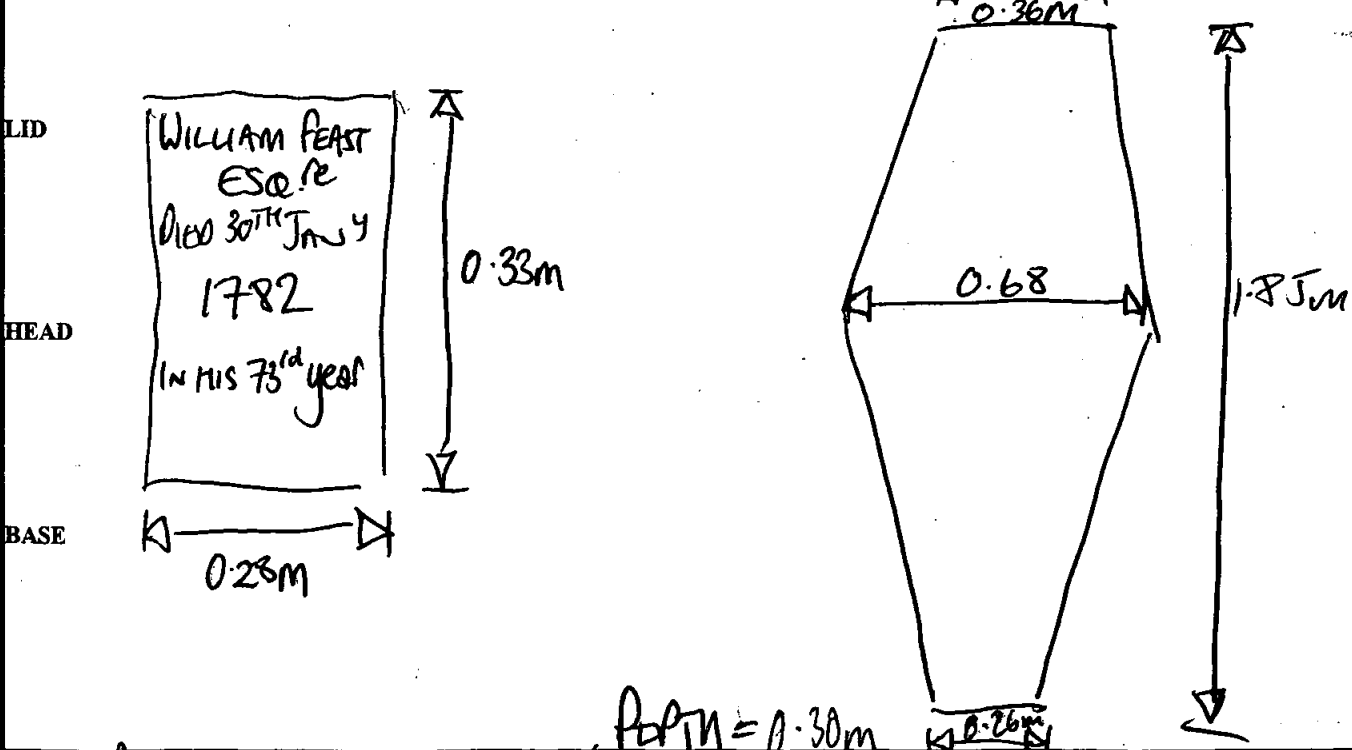

Recorder: [Signature]	Date: 23/10/00	Initials:
-----------------------	----------------	-----------



db

SITE	COFFIN RECORD SHEET	CONTEXT NO.
OLR00		776
Trench:	Additional sheets: 4.60 x 2	Treatment: <del>A</del> Neutobus
Site sub-div: Crypt, BM 2	Grave fills	
Plan no: 7	Grave cut:	Finds None
Section no:	Skeleton:	Breastplate <input checked="" type="checkbox"/> Grip
Co-ordinates:	Matrix location: (776)	Hinge Bracket
Levels	Preservation: AVERAGE	Fixing nails Shroud pins
Slide No.	Neg No:	Fabric Other finds

**Description** W & E ADULT BURIAL. 10 LINED COFFIN, SOLDERED (POORLY) TOP & BASE. BREASTPLATE AND SOLDERED (AGAIN, POORLY) I.O. PLATE ON BREAST OF COFFIN. WOOD REMAINS PRESENT AROUND COFFIN. SINGLE CROSS-MATCHING AND EXTERNAL LEAD LINING.

**Discussion**

Shape, dimensions and distinguishing characteristics

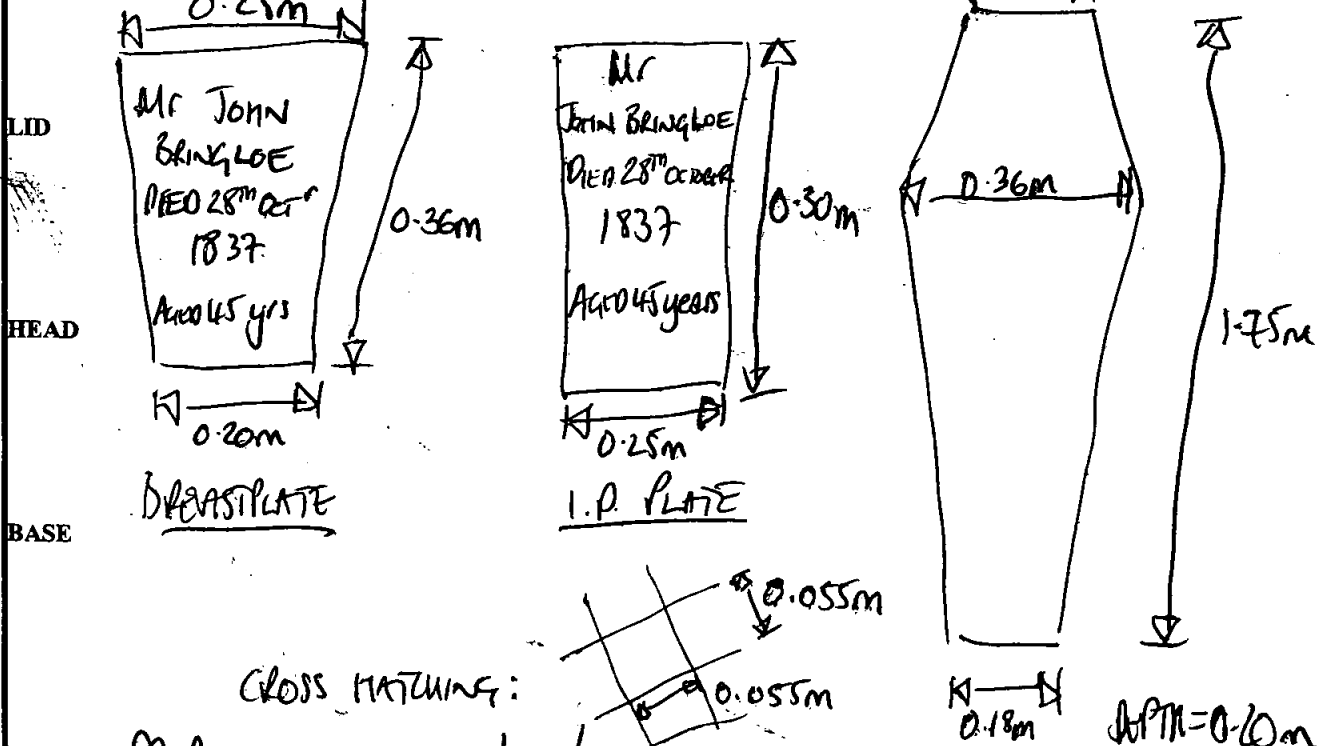

Recorder: <i>[Signature]</i>	Date: 23/10/00	Initials:
------------------------------	----------------	-----------

# Coffin Recording Sheet

Site Code

Context

OLR00

776

**Outer Coffin**

Sample Ret.

Recording Date ..... 24/10 .....

Associated Numbers .....

Condition .....

Dep. Plate

Legible

Inscription "Mr John/Bringloe/Died 28 Oct<sup>r</sup>/1837/Aged 45 Yrs<sup>r</sup>"

Fabric lead  ormolou  brass  tin plated pewter  gilt tin   
iron  silvered tin  enamelled  other ..... Sample Ret.

**Shape of dep. plate**

square  rectangle  shield  tapered  lozenge   
cartouche  oval  other .....

**Upholstery**

colour ..... shoddy  velvet  other ..... Sample Ret.

**Construction**

butt joint  mitred  pitched  other .....

Grip plate  Fabric = ormolou  brass  tin plated pewter  gilt tin   
iron  silvered tin  enamelled  other ..... Sample Ret.

Grip  Fabric = ormolou  brass  iron  Sample Ret.

Design swag of rose  horseshoe  cherub's head  plain   
other .....

Grip bolts  Corner bolts  Type = gilt brass  brass  iron   
other ..... Sample Ret.

Lid motifs  other ..... Sample Ret.

Escutcheons  other ..... Sample Ret.

Upholstery nails  brass  gilt brass  silvered brass  iron  enamelled   
other ..... Sample Ret.

Fixings  panel nails  screws  hinges  lace  Sample Ret.

Timber type ..... Sample Ret.

**Interpretation / Comments**

.....  
.....

db

SITE <u>OLR00</u>		COFFIN RECORD SHEET	CONTEXT NO. <u>777</u>
Trench:	Additional sheets:	Treatment:	
Site sub-div: <u>OCUP1, BM 2</u>	Grave fills	<u>bands/DNA covered</u>	
Plan no: <u>7</u>	Grave cut:	Finds	
Section no:	Skeleton: <u>GOOD</u>	None	
Co-ordinates:	Matrix location: <u>(777)</u>	Breastplate	
Levels	Preservation: <u>Average</u>	Grip <input checked="" type="checkbox"/>	
Slide No.	Neg No:	Hinge	
		Bracket	
		Fixing nails	
		Shroud pins	
		Fabric	
		Other finds	

Description WIFE ADULT BURIAL. PD LINED COFFIN SOLIDWOOD TOP & BRIDE WITH I.O. PLATE SOLIDWOOD TO THE BREAST OF COFFIN. TRACES OF WOOD REMAIN AROUND COFFIN.

Discussion

Shape, dimensions and distinguishing characteristics

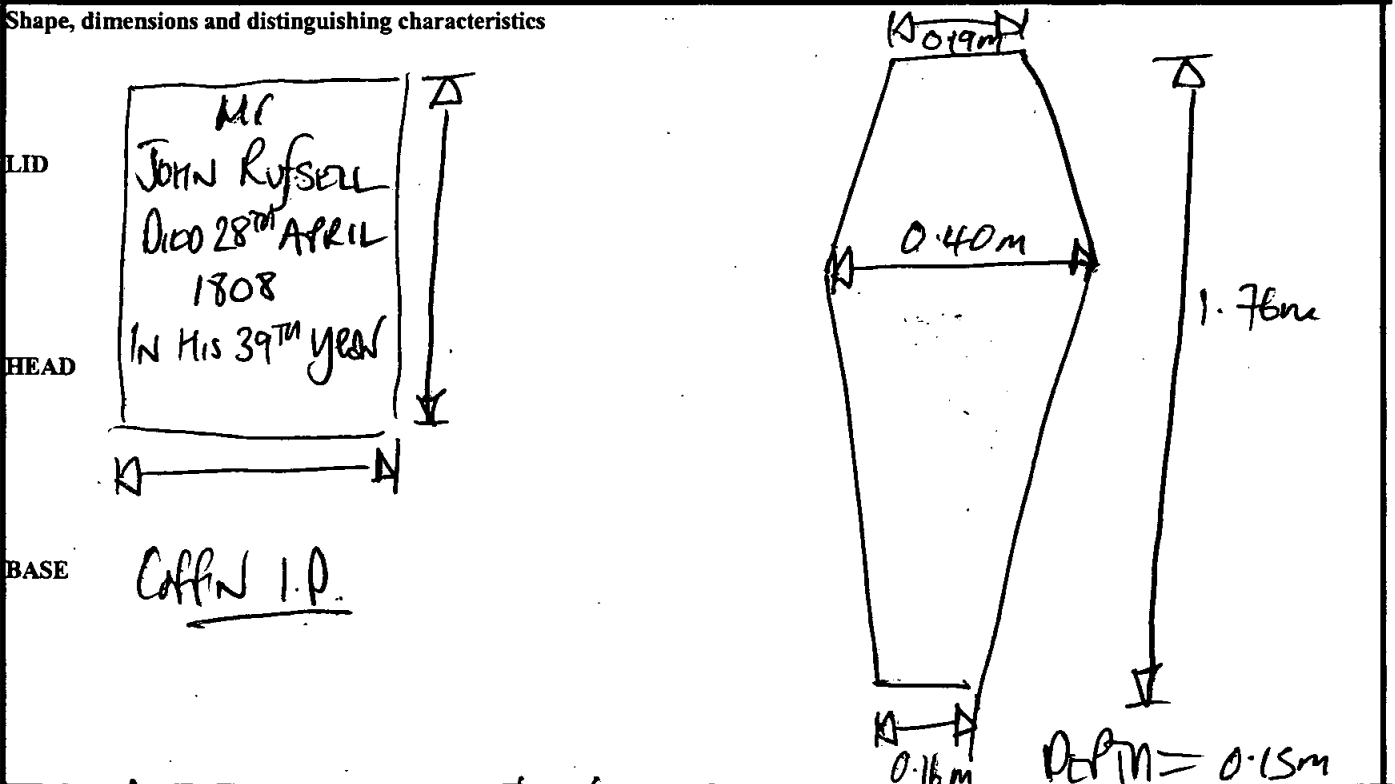

Recorder: <u>APM</u>	Date: <u>23/10/00</u>	Initials:
----------------------	-----------------------	-----------

old

SITE OLKOO	COFFIN RECORD SHEET	CONTEXT NO. 778
Trench:	Additional sheets:	Treatment:
Site sub-div: CAPT. BAY 2	Grave fills	BONES / DNA COLLECTED.
Plan no: 7	Grave cut:	Finds None
Section no:	Skeleton: GOOD	Breastplate Grip ✓
Co-ordinates:	Matrix location: 778	Hinge Bracket
Levels	Preservation: poor.	Fixing nails Shroud pins
Slide No.	Neg No:	Fabric Other finds

Description ~~ADULT~~ ADULT EURIAL. NO LINED COFFIN SOLID TOP & BASE, WOOD (EXTORWARD) TRACKS AROUND COFFIN. NO I.O. PLATE SOLDED TO BREAST OF COFFIN.

Discussion

Shape, dimensions and distinguishing characteristics

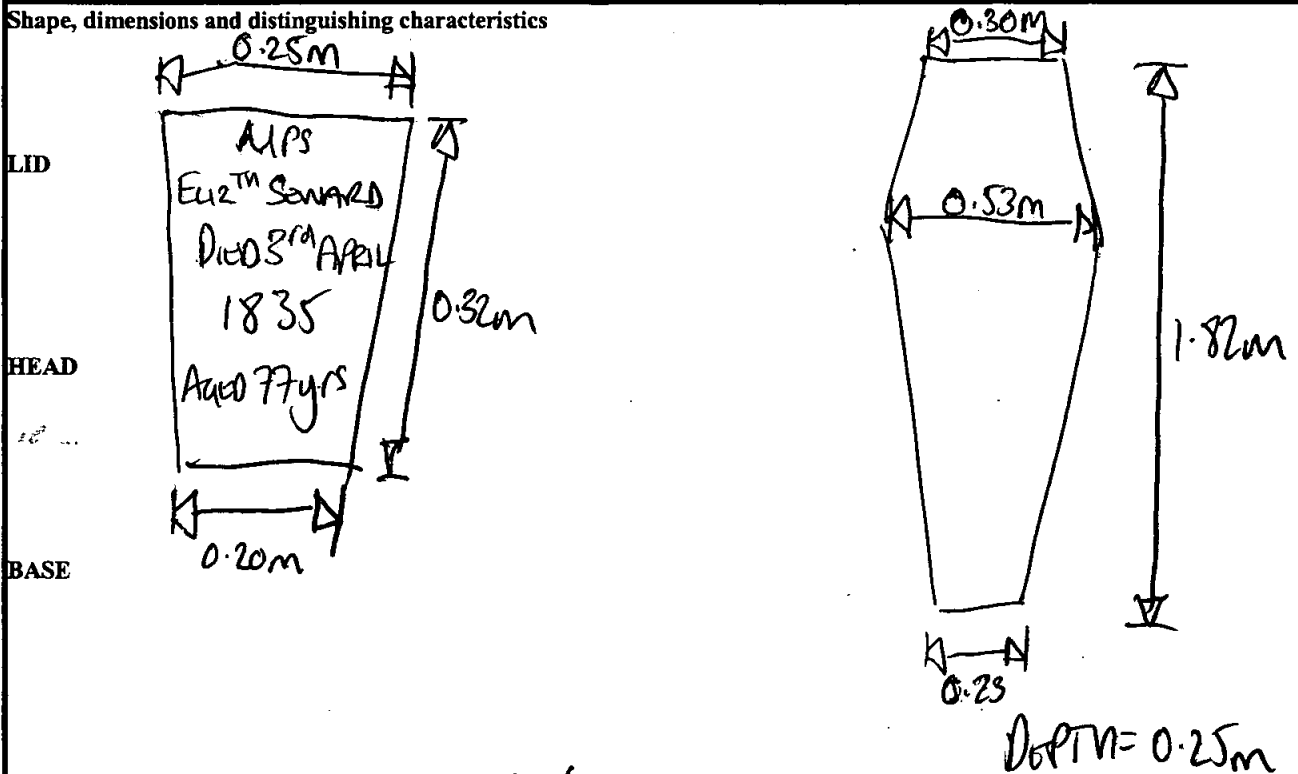

Recorder: <i>BAM</i>	Date: 25/10/00	Initials:
----------------------	----------------	-----------

# Coffin Recording Sheet

**Outer Coffin**

Sample Ret.

Site Code

Context

Recording Date 24/10

*Ohloo*

*778*

Associated Numbers .....

Condition 2

Dep. Plate

Legible

Inscription *"Mrs / Eliza<sup>h</sup> Seward / Died 3<sup>rd</sup> April / 1835 / Aged 77 Yrs"*

Fabric lead  ormolou  brass  tin plated pewter  gilt tin   
 iron  silvered tin  enamelled  other ..... Sample Ret.

**Shape of dep. plate**

square  rectangle  shield  tapered  lozenge   
 cartouche  oval  other ..... *plain, w/ no border at all*

**Upholstery**

colour ..... shoddy  velvet  other ..... Sample Ret.

**Construction**

butt joint  mitred  pitched  other .....

Grip plate  Fabric = ormolou  brass  tin plated pewter  gilt tin   
 iron  silvered tin  enamelled  other ..... Sample Ret.

Grip  Fabric = ormolou  brass  iron  *x1* Sample Ret.

Design swag of rose  horseshoe  cherub's head  *(1)* plain   
 other .....

Grip bolts  Corner bolts  Type = gilt brass  brass  iron   
 other ..... Sample Ret.

Lid motifs  other ..... Sample Ret.

Escutcheons  other ..... Sample Ret.

Upholstery nails  brass  gilt brass  silvered brass  iron  enamelled   
 other ..... Sample Ret.

Fixings  panel nails  screws  hinges  lace  Sample Ret.

Timber type ..... Sample Ret.

**Interpretation / Comments**

.....  
 .....

db

SITE OLR 00	COFFIN RECORD SHEET	CONTEXT NO. 779
Trench:	Additional sheets:	Treatment: bone/DNA covered
Site sub-div: <u>CRUPT, BAY 2</u>	Grave fills	
Plan no: 7	Grave cut:	Finds None
Section no:	Skeleton:	Breastplate Grip
Co-ordinates:	Matrix location: (779)	Hinge Bracket
Levels	Preservation: <u>POOR</u>	Fixing nails Shroud pins
Slide No.	Neg No:	Fabric Other finds

**Description** W-E ADULT BURIAL. No LINDO coffin found & removed top & base. No I.D. PLATE secured to breast of coffin. FOOT PLATE PINNED TO OAK-WOOD TRACES AT ANKLES. REMAINS of SHROUD WITHIN COFFIN.

**Discussion**

Shape, dimensions and distinguishing characteristics

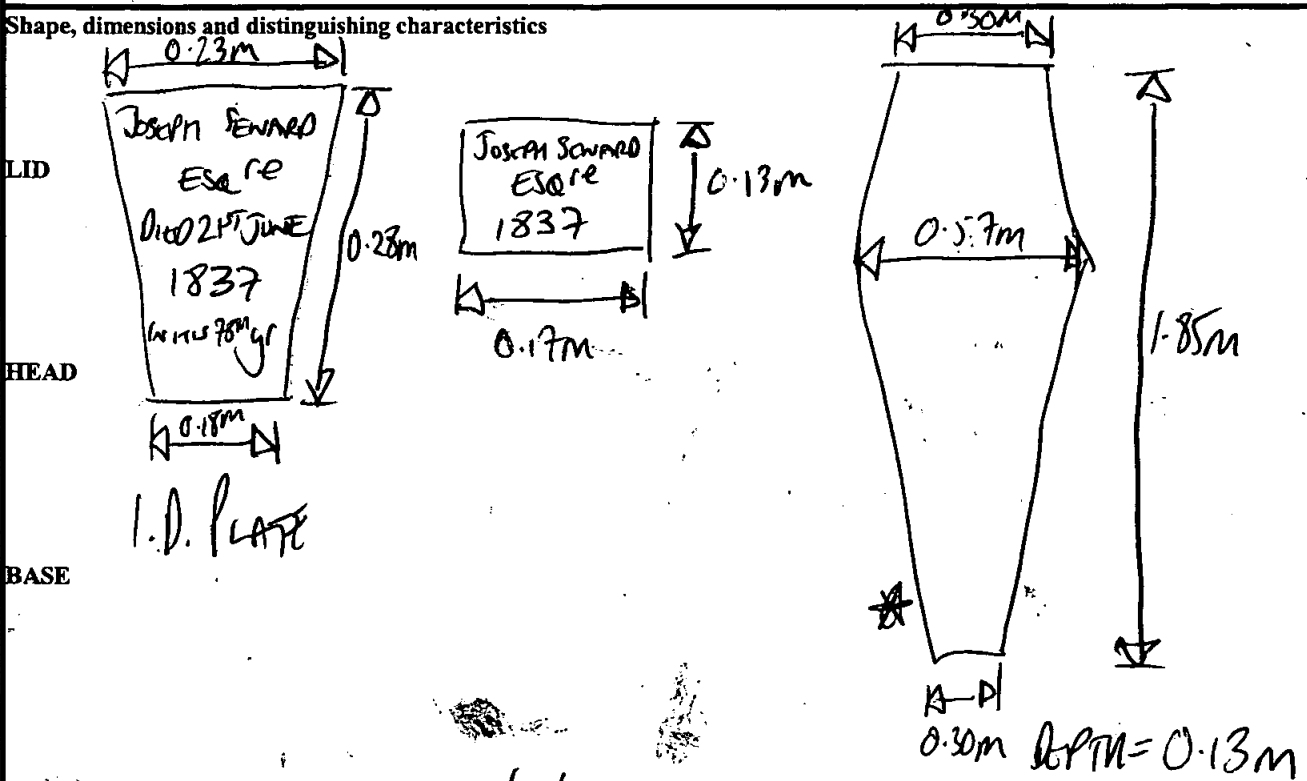

Recorder: <u>DM</u>	Date: <u>23/10/00</u>	Initials:
---------------------	-----------------------	-----------

db

SITE <b>OLR00</b>	COFFIN RECORD SHEET	CONTEXT NO. <b>780</b>
Trench:	Additional sheets: <b>YES x 1</b>	Treatment:
Site sub-div: <b>CRUT, bay 4</b>	Grave fills	<b>NECROPOLIS</b>
Plan no: <b>7x</b>	Grave cut:	Finds
Section no:	Skeleton:	None
Co-ordinates:	Matrix location: <b>(780)</b>	Breastplate
Levels	Preservation: <b>SP0A</b>	Grip
Slide No.	Neg No:	Hinge
		Bracket
		Fixing nails
		Shroud pins
		Fabric
		Other finds

Description **E-W INFANT BURIAL. NO LINED COFFIN (OLD) TOP & BASE. EXTERIOR COFFIN WOOD PINS. SURRENO COFFIN. ENGRAVED NAME PLAQUE ON BREAST OF COFFIN.**

Discussion

Shape, dimensions and distinguishing characteristics

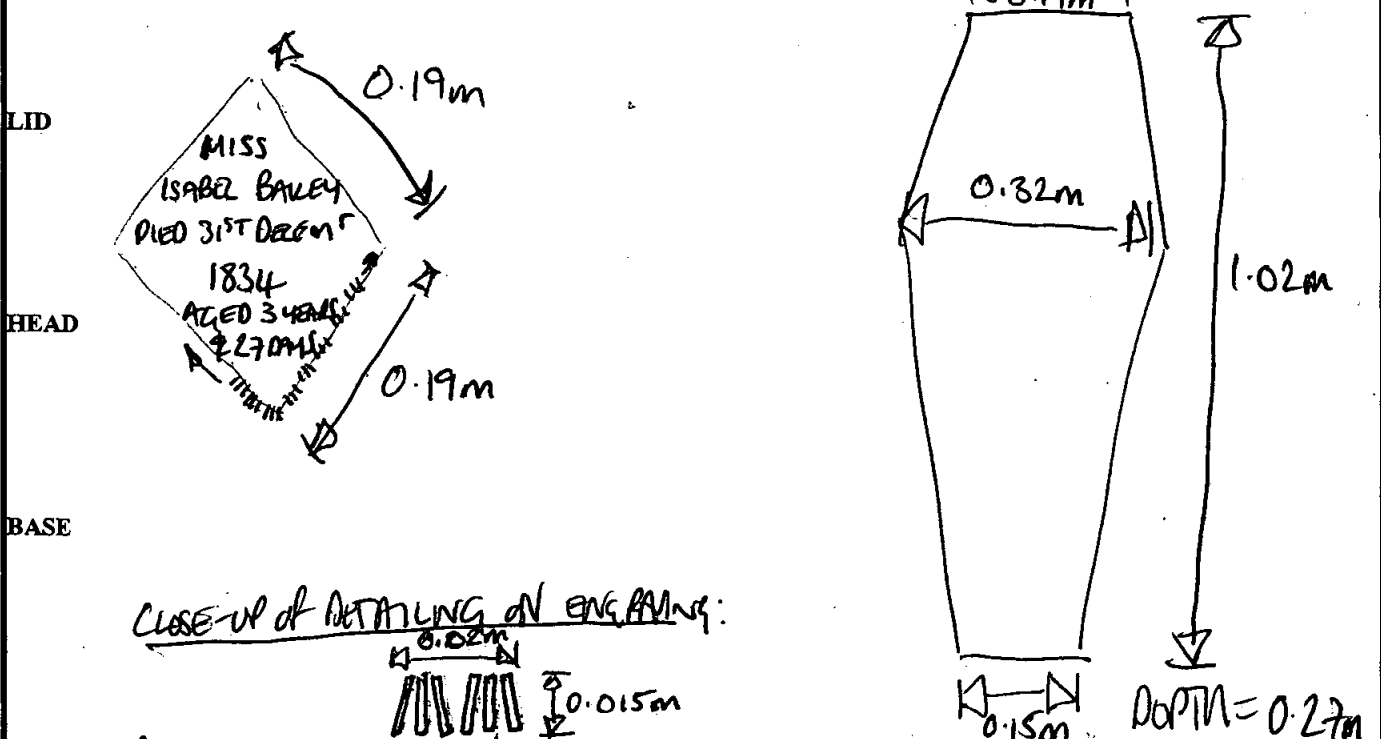

Recorder: <b>BM</b>	Date: <b>23/12/00</b>	Initials:
---------------------	-----------------------	-----------

# Coffin Recording Sheet

**Outer Coffin**

Sample Ret.

Site Code

Context

02200

780

Recording Date ..... 24/10 .....

Associated Numbers .....

Condition .....

Dep. Plate

Legible

Inscription

Fabric lead  ormolou  brass  tin plated pewter  gilt tin   
 iron  silvered tin  enamelled  other ..... Sample Ret.

**Shape of dep. plate**

square  rectangle  shield  tapered  lozenge   
 cartouche  oval  other .....

**Upholstery**

colour ..... shoddy  velvet  other ..... Sample Ret.

**Construction**

butt joint  mitred  pitched  other .....

**Grip plate**  Fabric = ormolou  brass  tin plated pewter  gilt tin   
 iron  silvered tin  enamelled  other ..... Sample Ret.

*ribs on rev of grip.*

**Grip**  Fabric = ormolou  brass  iron  x1 Sample Ret.

**Design**

swag of rose  horseshoe  cherub's head  plain

other ..... *infert ①*

**Grip bolts**  **Corner bolts**  **Type =** gilt brass  brass  iron

other ..... Sample Ret.

**Lid motifs**  other ..... Sample Ret.

**Escutcheons**  other ..... Sample Ret.

**Upholstery nails**  brass  gilt brass  silvered brass  iron  enamelled

other ..... Sample Ret.

**Fixings**  panel nails  screws  hinges  lace  Sample Ret.

**Timber type** ..... Sample Ret.

**Interpretation / Comments**

.....  
 .....



db

SITE <b>OLKOO</b>		COFFIN RECORD SHEET	CONTEXT NO. <b>781</b>
Trench:	Additional sheets:	Treatment:	
Site sub-div: <b>OLUPI, BAY 4</b>	Grave fills:	<b>BONES/DNA CONSERVED.</b>	
Plan no: <b>7</b>	Grave cut:	Finds	
Section no:	Skeleton: <b>(781)</b>	None	
Co-ordinates:	Matrix location:	Breastplate	
Levels:	Preservation: <b>Average/Pool</b>	Grip	
Slide No.:	Neg No.:	Hinge	
		Bracket	
		Fixing nails	
		Shroud pins	
		Fabric	
		Other finds	

Description **E-W INHUM BURIAL. Pb LINED COFFIN WITH OUTER WOOD TRACES. Pb SOLDERED TOP & BASE. COFFIN I.D. RINGS SOLDERED TO BREAST OF COFFIN.**

Discussion

Shape, dimensions and distinguishing characteristics

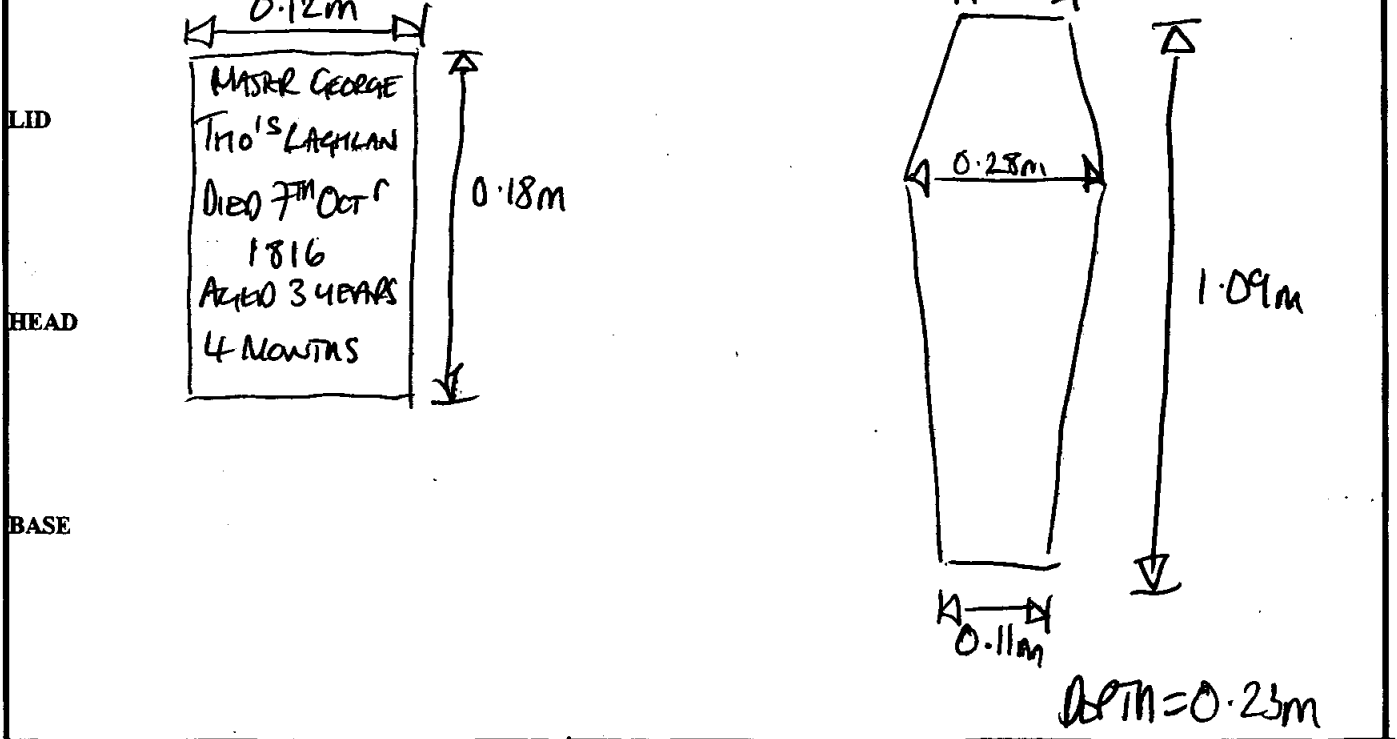

Recorder: <b>(RM)</b>	Date: <b>23/10/00</b>	Initials:
-----------------------	-----------------------	-----------

db

SITE <u>OLR00</u>		COFFIN RECORD SHEET	CONTEXT NO. <u>782</u>
Trench:	Additional sheets: <u>YES x 1</u>	Treatment: <u>bone/DNA collected</u>	
Site sub-div: <u>OLPT, BAU4</u>	Grave fills		
Plan no: <u>7</u>	Grave cut:	Finds None	
Section no:	Skeleton:	Breastplate Grip <input checked="" type="checkbox"/> <u>SEE OVER.</u>	
Co-ordinates:	Matrix location: <u>(782)</u>	Hinge Bracket	
Levels	Preservation: <u>bone</u>	Fixing nails Shroud pins	
Slide No.	Neg No:	Fabric Other finds	

Description EDW ADULT BURIAL. Ph Coffin with curved wood TRACED. Coffin secured top & side. ENGRAVED NAME-PLATE LOCATED ON BREAST of coffin. NAIL GRIPS (TORTOISESHELL) PRESENT ON REAR SKULL

Discussion \*

Shape, dimensions and distinguishing characteristics

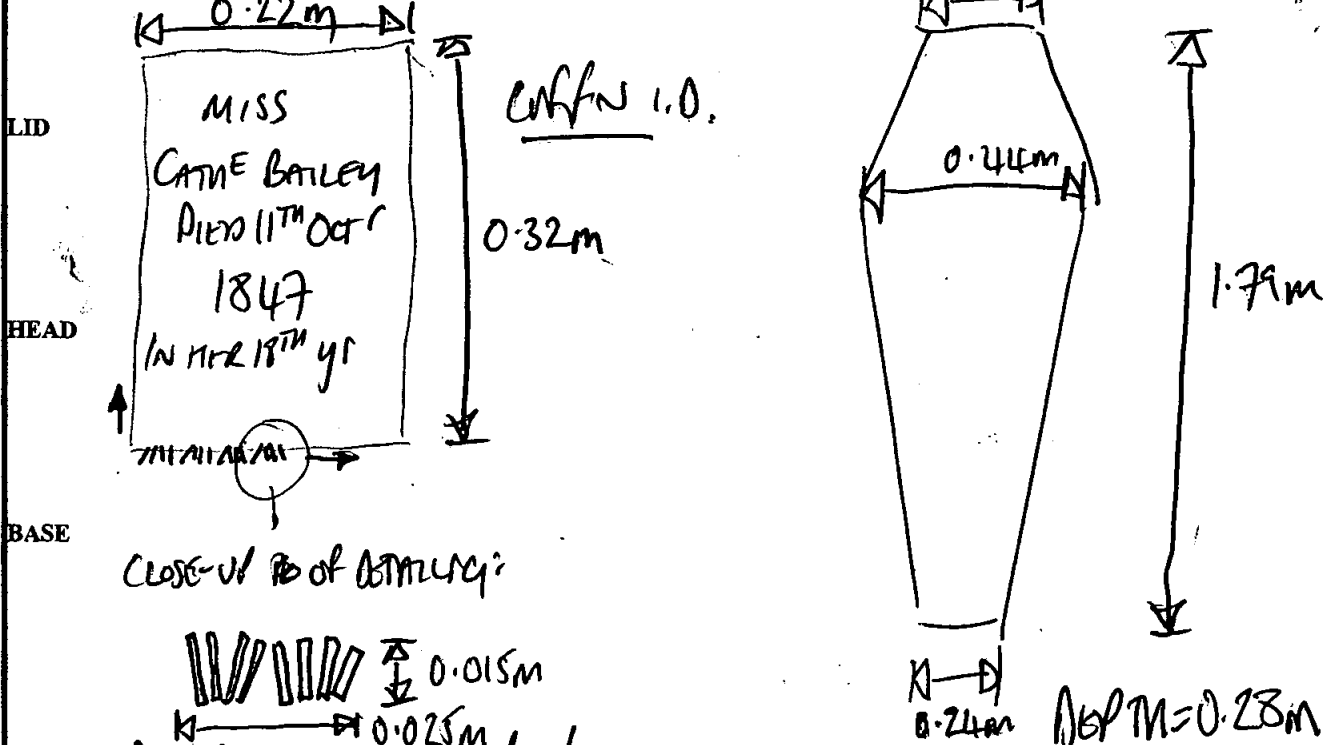

Recorder: <u>[Signature]</u>	Date: <u>23/10/00</u>	Initials:
------------------------------	-----------------------	-----------

# Coffin Recording Sheet

Site Code

Context

**Outer Coffin**

Sample Ret.

Ohloo

782

Recording Date ..... 24/10 .....

Associated Numbers .....

Condition .....

Dep. Plate

Legible

Inscription

Fabric lead  ormolou  brass  tin plated pewter  gilt tin   
iron  silvered tin  enamelled  other ..... Sample Ret.

**Shape of dep. plate**

square  rectangle  shield  tapered  lozenge   
cartouche  oval  other .....

**Upholstery**

colour ..... shoddy  velvet  other ..... Sample Ret.

**Construction**

butt joint  mitred  pitched  other .....

**Grip plate**  Fabric = ormolou  brass  tin plated pewter  gilt tin   
iron  silvered tin  enamelled  other ..... Sample Ret.

**Grip**  Fabric = ormolou  brass  iron  Sample Ret.

**Design** swag of rose  horseshoe  cherub's head  plain   
other ..... (A)

**Grip bolts**  **Corner bolts**  Type = gilt brass  brass  iron   
other ..... Sample Ret.

**Lid motifs**  other ..... Sample Ret.

**Escutcheons**  other ..... Sample Ret.

**Upholstery nails**  brass  gilt brass  silvered brass  iron  enamelled   
other ..... Sample Ret.

**Fixings**  panel nails  screws  hinges  lace  Sample Ret.

**Timber type** ..... Sample Ret.

**Interpretation / Comments**

.....  
.....

db

SITE OLR 00	COFFIN RECORD SHEET	CONTEXT NO. 7823
Trench:	Additional sheets:	Treatment:
Site sub-div: OCHT, BM 2	Grave fills	BONES CONSERVED
Plan no: 7	Grave cut:	Finds None ✓
Section no:	Skeleton:	Breastplate Grip
Co-ordinates:	Matrix location: 782	Hinge Bracket
Levels	Preservation: Poor	Fixing nails Shroud pins
Slide No.	Neg No:	Fabric Other finds

**Description** E-W ADULT BURIAL. Pb LINED coffin, sawed TOP & BASE. NO NAME. NO SIGN of actual wood coffin

**Discussion**

**Shape, dimensions and distinguishing characteristics**

LID

NO NAME

HEAD

BASE

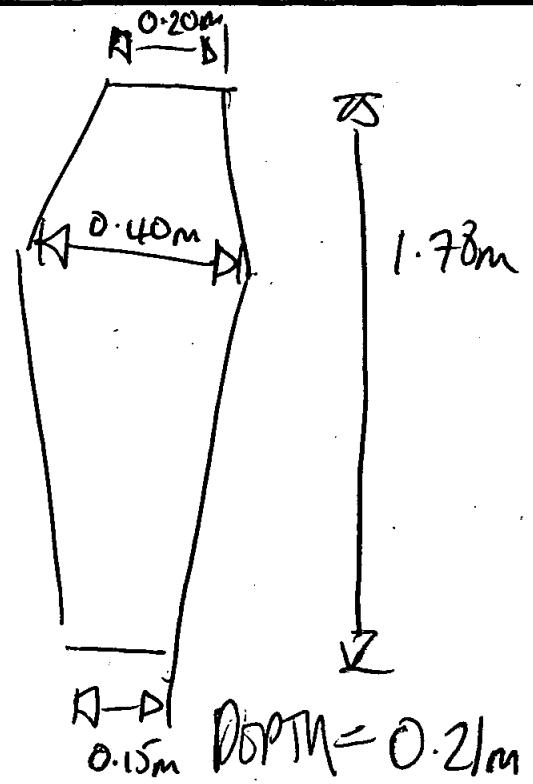

Recorder: DM	Date: 24/10/00	Initials:
--------------	----------------	-----------

dp

SITE		COFFIN RECORD SHEET		CONTEXT NO. 78A	
Trench:	Additional sheets: 465 x 1	Treatment: <input checked="" type="checkbox"/> Necropolis			
Site sub-div: <u>cutt. 6m 2</u>	Grave fills	<del>None</del> <u>Lead lined</u>			
Plan no: 7	Grave cut:	Finds			
Section no:	Skeleton: <u>Poor</u>	None			
Co-ordinates:	Matrix location: <u>78A</u>	Breastplate <input checked="" type="checkbox"/>			
Levels	Preservation: <u>Average</u>	Grip <input checked="" type="checkbox"/>			
Slide No.	Neg No:	Hinge			
		Bracket			
		Fixing nails			
		Shroud pins			
		Fabric			
		Other finds			

**Description** E-W ADULT BURIAL. POLISHED COFFIN, SOLDERED TOP & BASE. TRACES OF OUTER WOOD VISIBLE. BREASTPLATE PINNED TO REINS OF OUTER WOODEN COFFIN. Pb I.D. PLATE SOLDERED TO BREAST OF COFFIN. DRAW FILED. INNER WOOD SLITS FOR SHOULDER OF COFFIN EACH 0.10M WIDE, 0.32M DEPTH - SAME

**Discussion** PRESERVED REMAINS DISCOVERED - RE-SEALED AND SENT TO NECROPOLIS.

Shape, dimensions and distinguishing characteristics

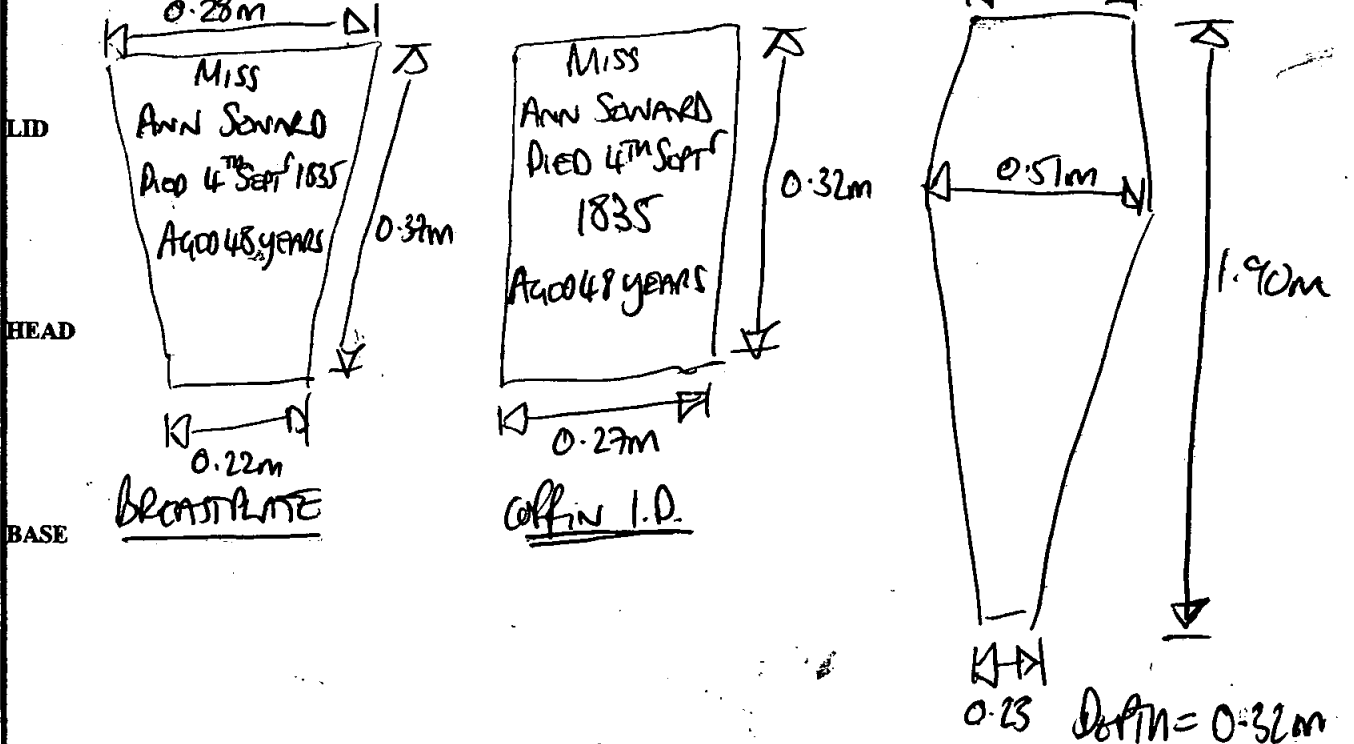

Recorder: <u>DM</u>	Date: <u>24/10/00</u>	Initials:
---------------------	-----------------------	-----------

# Coffin Recording Sheet

Site Code

Context

**Outer Coffin**

Sample Ret.

OLR00

78B

Recording Date ..... 24/10 .....

Associated Numbers .....

Condition .....

Dep. Plate

Legible

Inscription "Miss/Ann Senoed/ Died 4 Sept<sup>r</sup> 1835/ Aged 48 Years"

Fabric lead  ormolou  brass  tin plated pewter  gilt tin   
 iron  silvered tin  enamelled  other ..... Sample Ret.

**Shape of dep. plate**

square  rectangle  shield  tapered  lozenge   
 cartouche  oval  other ..... *Some as 776 w/534 outer border*  
*black polished.*

**Upholstery**

colour ..... shoddy  velvet  other ..... Sample Ret.

**Construction**

butt joint  mitred  pitched  other .....

**Grip plate**

Fabric = ormolou  brass  tin plated pewter  gilt tin

iron  silvered tin  enamelled  other ..... Sample Ret.   
*frag on rear of grip*

**Grip**

Fabric = ormolou  brass  iron  36 Sample Ret.

**Design**

swag of rose  horseshoe  cherub's head  plain

other .....

**Grip bolts**

Corner bolts  Type = gilt brass  brass  iron

other ..... Sample Ret.

**Lid motifs**

other ..... Sample Ret.

**Escutcheons**

other ..... Sample Ret.

**Upholstery nails**

brass  gilt brass  silvered brass  iron  enamelled

other ..... Sample Ret.

**Fixings**

panel nails  screws  hinges  lace  Sample Ret.

**Timber type** .....

Sample Ret.

**Interpretation/ Comments**

.....  
 .....

db

SITE	COFFIN RECORD SHEET	CONTEXT NO.
OUR00		785
Trench:	Additional sheets:	Treatment:
Site sub-div: <i>QMA, BM2</i>	Grave fills	<i>Neutolous</i>
Plan no: <i>7</i>	Grave cut:	Finds None
Section no:	Skeleton:	Breastplate <input checked="" type="checkbox"/> Grip
Co-ordinates:	Matrix location: <i>785</i>	Hinge Bracket
Levels	Preservation: <i>Average</i>	Fixing nails Shroud pins
Slide No.	Neg No:	Fabric Other finds

Description *W-NE ADULT BURIAL. Pb LINDO COFFIN SOLDERED TOP & BASE. TRACES OF EXTERNAL WOOD COFFIN PRESENT. I.D. PLATE SOLDERED TO BREAST OF COFFIN. "CHARLES HOLLENGART"?*

Discussion

Shape, dimensions and distinguishing characteristics

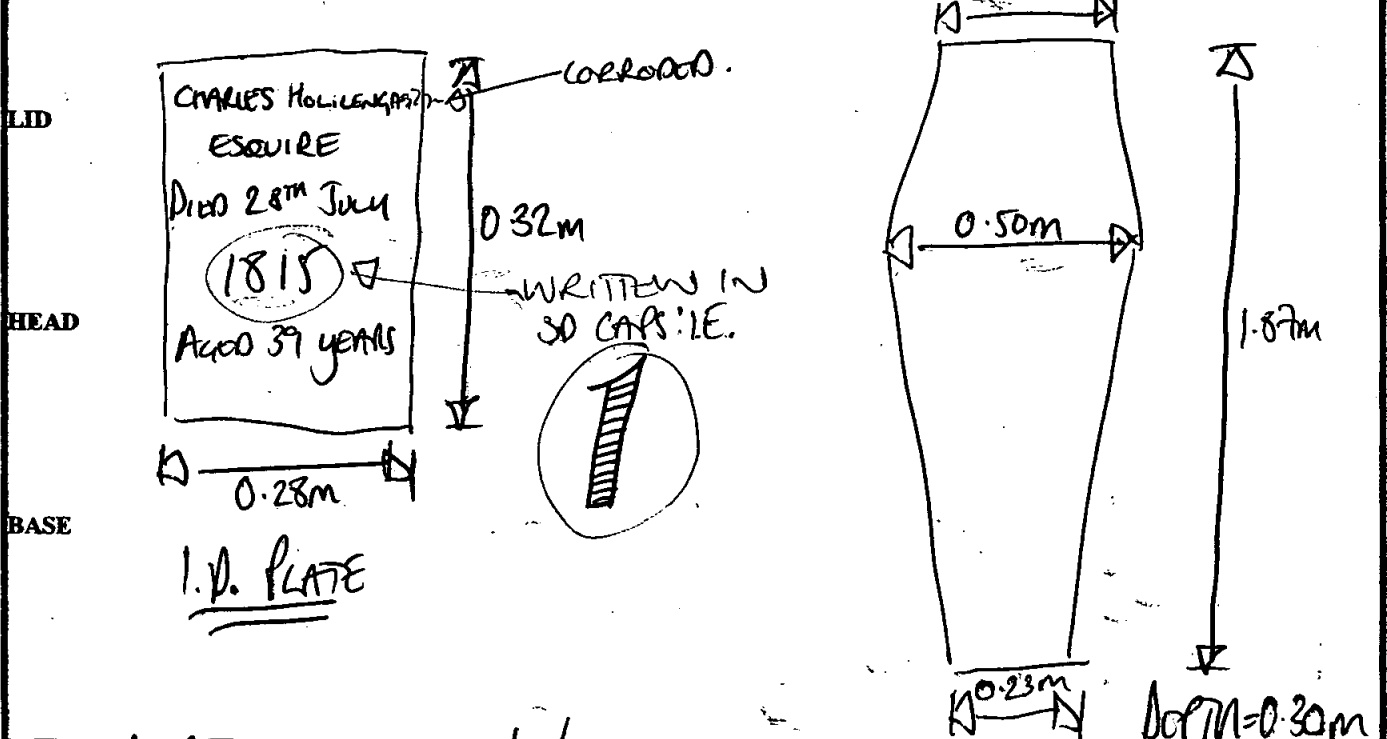

Recorder: *[Signature]* Date: *24/10/00* Initials:

dk

SITE <u>OLR00</u>		COFFIN RECORD SHEET	CONTEXT NO. <u>786</u>
Trench:	Additional sheets:	Treatment:	
Site sub-div: <u>CRYP, BM2</u>	Grave fills:	<u>Necropolis</u>	
Plan no: <u>7</u>	Grave cut:	Finds	
Section no:	Skeleton:	None <input checked="" type="checkbox"/>	
Co-ordinates:	Matrix location: <u>786</u>	Breastplate	
Levels:	Preservation: <u>poor</u>	Grip	
Slide No.:	Neg No.:	Hinge	
		Bracket	
		Fixing nails	
		Shroud pins	
		Fabric	
		Other finds	

**Description** E-W ADULT BURIAL. Pb lined coffin soldered top & base. ~~the~~ Coffin soldered i.p. PLATE MISSING. TRACES of other wood coffin still visible. NO NAME.

**Discussion**

**Shape, dimensions and distinguishing characteristics**

LID

No NAME

HEAD

BASE

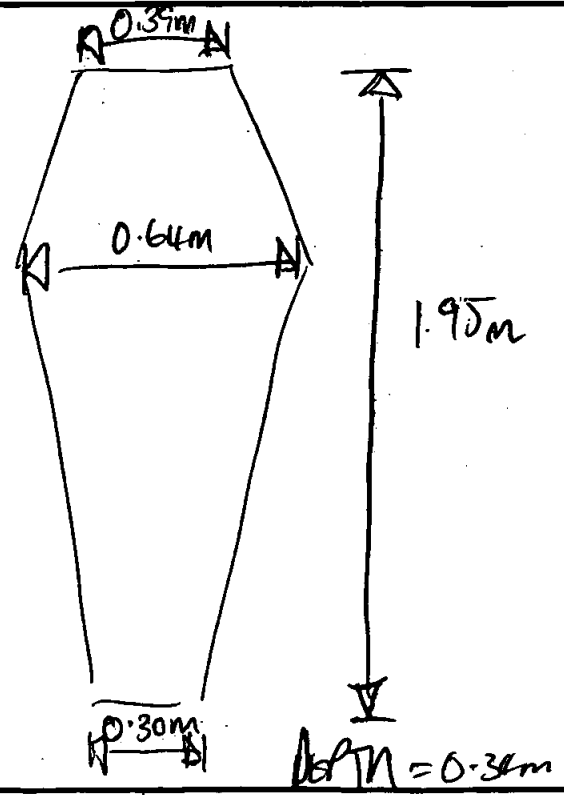

Recorder: [Signature]

Date: 24/10/00

Initials:



db

SITE <b>OLKOO</b>		COFFIN RECORD SHEET		CONTEXT NO. <b>787</b>	
Trench:		Additional sheets:		Treatment:	
Site sub-div: <b>OLM1, BAY 2</b>		Grave fills:		<b>Earthen covering</b>	
Plan no: <b>7</b>		Grave cut:		Finds	
Section no:		Skeleton: <b>poor</b>		None	
Co-ordinates:		Matrix location: <b>(787)</b>		Breastplate	
Levels:		Preservation: <b>poor</b>		Grip	
Slide No.:		Neg No.:		Hinge	
				Bracket	
				Fixing nails	
				Shroud pins	
				Fabric	
				Other finds	

**Description** W-E ASHT AREA. PO LIND COFFIN. SERRATED TOP & BASE. TRACES of an outer WOOD coffin PRESENT. NO NAME. SHROUD AROUND SKELETON.

**Discussion**

**Shape, dimensions and distinguishing characteristics**

LID **NO NAME**

HEAD

BASE

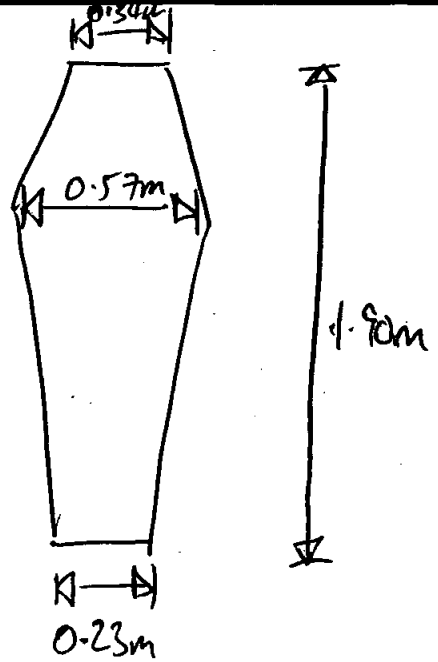

**DEPTH = 0.23m**

Recorder: <b>OSM</b>	Date: <b>24/1/00</b>	Initials:
----------------------	----------------------	-----------

do

SITE		COFFIN RECORD SHEET		CONTEXT NO. 788	
Trench:	Additional sheets:	Treatment: Bone/DNA conservation			
Site sub-div: CAUPT, BAM 2	Grave fills				
Plan no: 7	Grave cut:	Finds: None			
Section no:	Skeleton: GOOD-SLIGHTLY CRUSHED.	Breastplate: Grip ✓			
Co-ordinates:	Matrix location: 788	Hinge: Bracket			
Levels	Preservation: Poor	Fixing nails: Shroud pins			
Slide No.	Neg No:	Fabric: Other finds:			

**Description** E-W ADULT BURIAL. PD LINED COFFIN SCRUBBED TOP & BASE. TRACES OF OUTER WOOD PRESENT. COFFIN I.D. ON BREAST OF COFFIN HAS BEEN CUT OUT & REPLACED (POSS. AS A RESULT OF ERROR ON ORIGINAL) WITH PD SLATED SIMILAR SIZE, RE-SCRUBBED TO TOP. (SEE DRAW) ~~HEAD~~ PLATE PRESENT, PINNED TO OUTER COFFIN AT ANTERIORS. TROUSER BUTTON <sup>HEAD</sup> FOUND OUTSIDE OF PELVIS.

**Discussion**

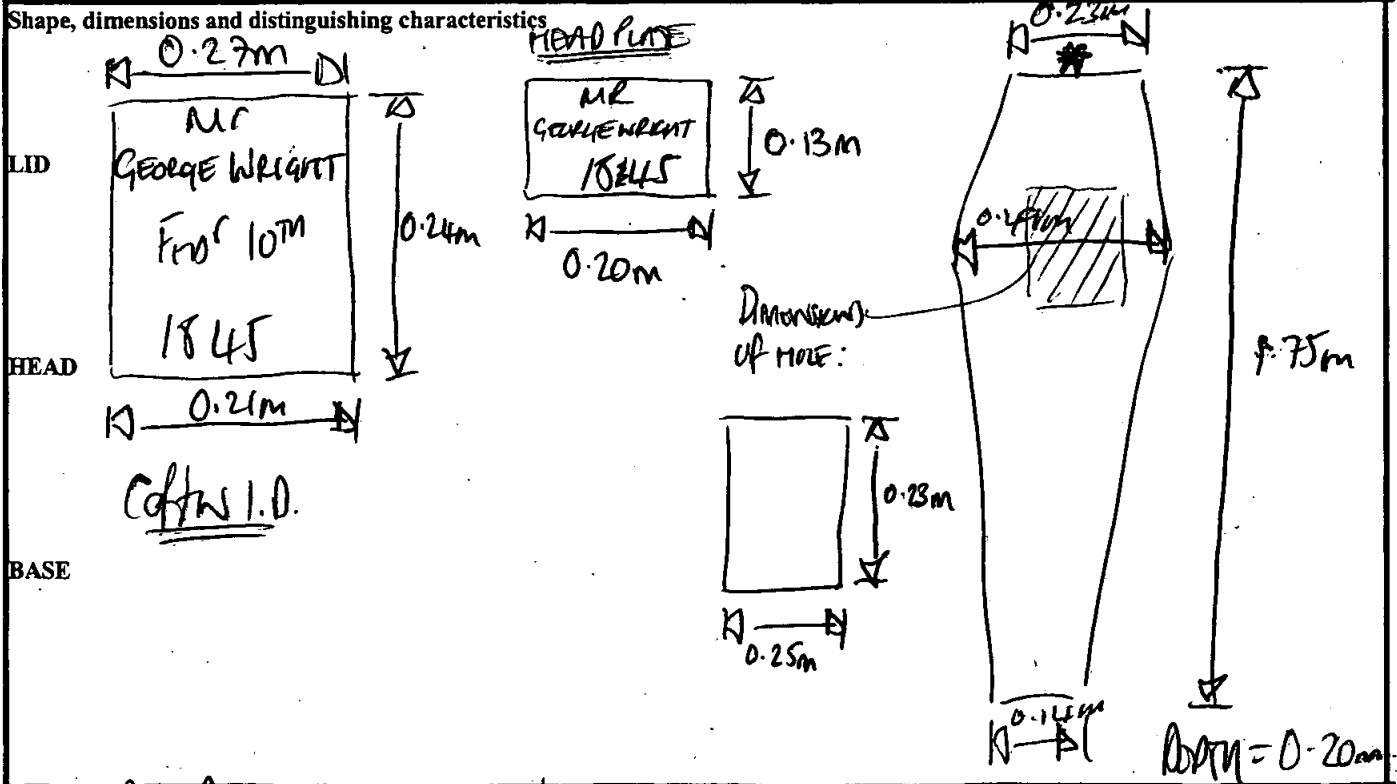

Recorder: [Signature] Date: 24/10/00 Initials:

# Coffin Recording Sheet

Site Code

Context

**Outer Coffin**

Sample Ret.

0LR00

788

Recording Date ..... 15/2/01

Associated Numbers .....

Condition ..... 3

Foot/head

Dep. Plate

Legible

Inscription *Mr/George Weight/ Feb 10/ 1845.*

Fabric lead  ormolou  brass  tin plated pewter  gilt tin   
 iron  silvered tin  enamelled  other ..... Sample Ret.

**Shape of dep. plate**

square  rectangle  shield  tapered  lozenge   
 cartouche  oval  other .....

**Upholstery**

colour ..... shoddy  velvet  other ..... Sample Ret.

**Construction**

butt joint  mitred  pitched  other .....

Grip plate  Fabric = ormolou  brass  tin plated pewter  gilt tin   
 iron  silvered tin  enamelled  other ..... Sample Ret.

Grip  Fabric = ormolou  brass  iron  Sample Ret.

Design swag of rose  horseshoe  cherub's head  plain   
 other ..... *x1 (4)*

Grip bolts  Corner bolts  Type = gilt brass  brass  iron   
 other ..... Sample Ret.

Lid motifs  other ..... Sample Ret.

Escutcheons  other ..... Sample Ret.

Upholstery nails  brass  gilt brass  silvered brass  iron  enamelled   
 other ..... Sample Ret.

Fixings  panel nails  screws  hinges  lace  Sample Ret.

Timber type ..... Sample Ret.

**Interpretation / Comments**

.....  
 .....

db.

SITE <u>Orkoo</u>		COFFIN RECORD SHEET	CONTEXT NO. <u><del>788</del> 789</u>
Trench:	Additional sheets:	Treatment: <u>bone/DNA covered</u>	
Site sub-div: <u>CLMPT, BM2</u>	Grave fills:		
Plan no: <u>7</u>	Grave cut:	Finds None <input checked="" type="checkbox"/>	
Section no:	Skeleton: <u>Good.</u>	Breastplate Grip	
Co-ordinates:	Matrix location: <u>(789)</u>	Hinge Bracket	
Levels:	Preservation: <u>Good</u>	Fixing nails Shroud pins	
Slide No.	Neg No:	Fabric Other finds	

**Description** W-DE ADULT BURIAL. Pb LINCOLN coffin, PINNED TOP & BASE. TRACES OF WOOD FROM AROUND COFFIN PRESENT. Pb 'DIAMOND' I.D. PLATE SOLDERED TO BREAST OF COFFIN.

**Discussion**

**Shape, dimensions and distinguishing characteristics**

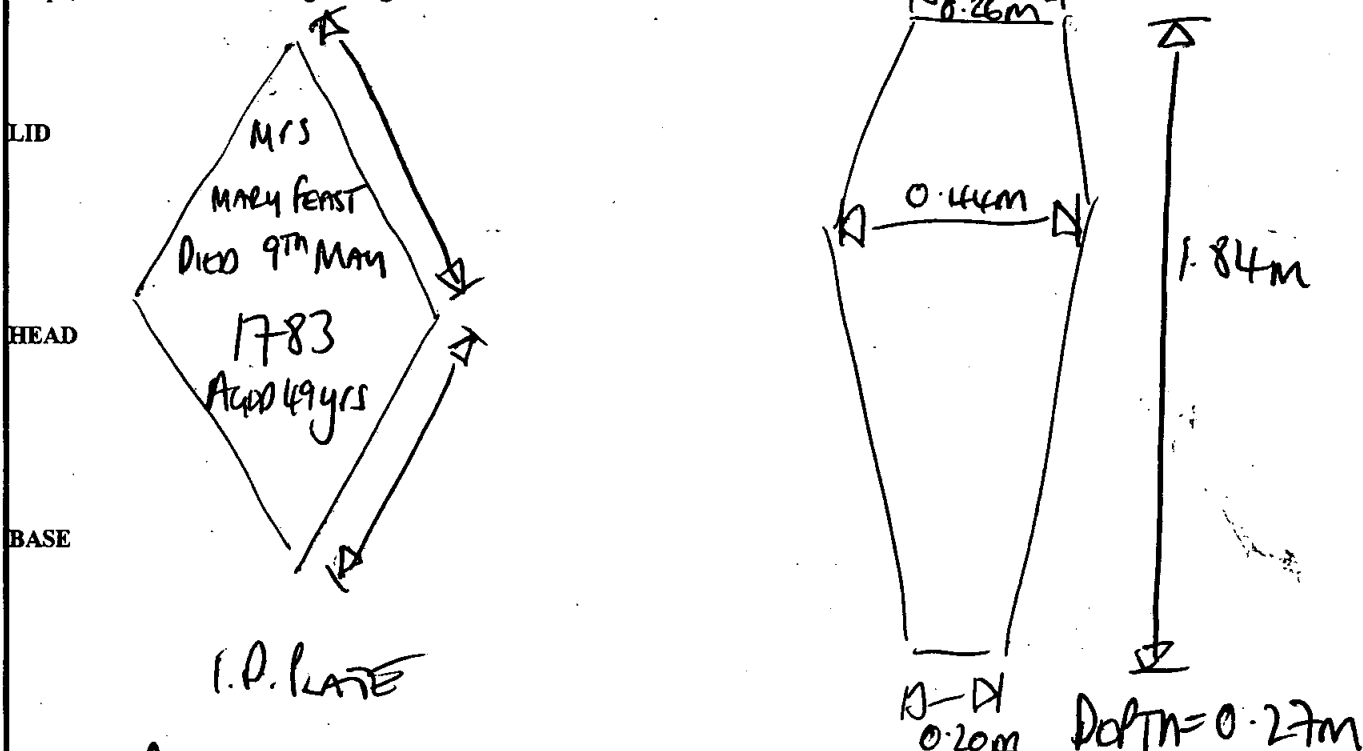

Recorder: <u>ARM</u>	Date: <u>24/10/00</u>	Initials:
----------------------	-----------------------	-----------

db

SITE OLR00	COFFIN RECORD SHEET	CONTEXT NO. 790
Trench:	Additional sheets:	Treatment: BONES LIFTED
Site sub-div: CHURCH BAY 4	Grave fills	
Plan no: 7	Grave cut:	Finds None ✓
Section no:	Skeleton: PART MISSING (SKULL ETC) - ROBBERED.	Breastplate Grip
Co-ordinates:	Matrix location: a/541	Hinge Bracket
Levels	Preservation: Corroded / Breached	Fixing nails Shroud pins
Slide No.	Neg No:	Fabric Other finds

Description Pb coffin - skull (1 more) robbed  
- the WEST/HEAD END CUT OPEN

Discussion - NO NAME

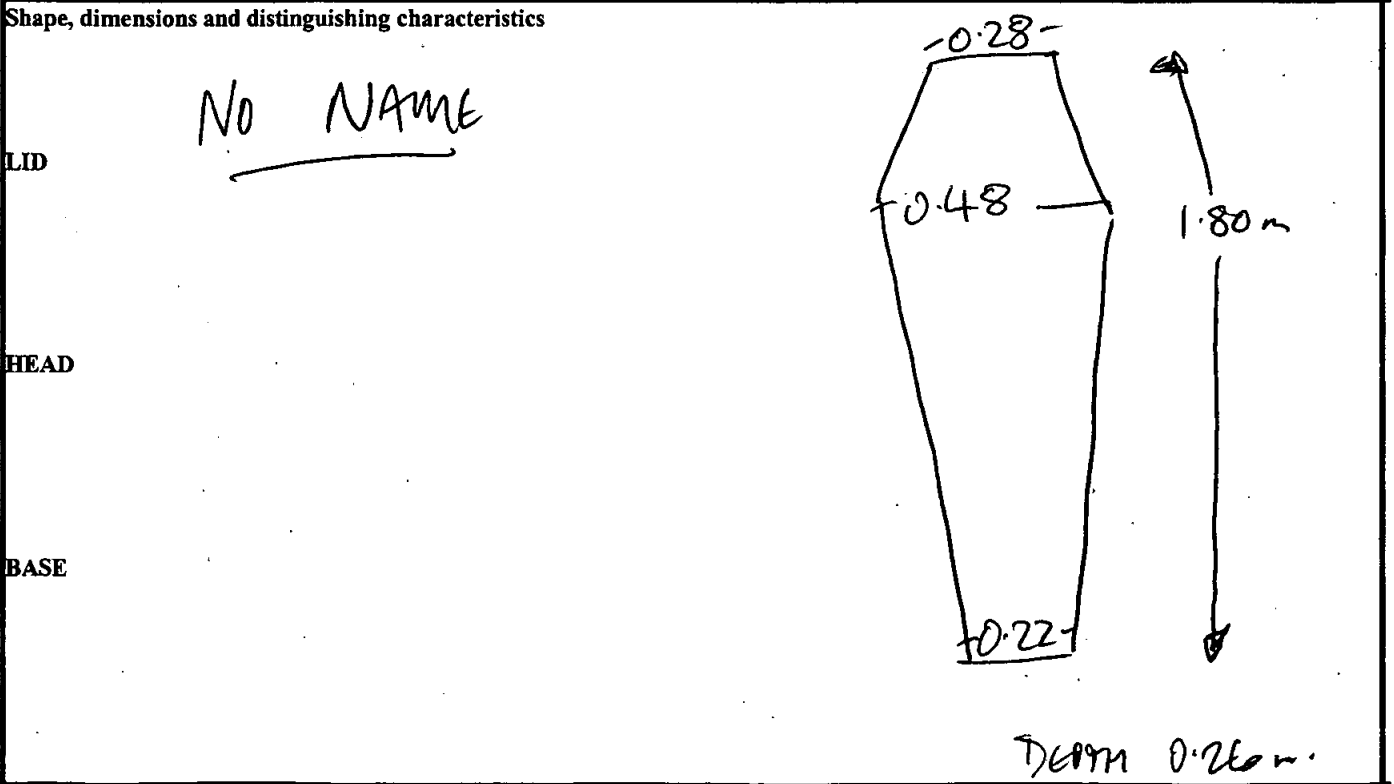

Recorder: <i>Tm</i>	Date: 25.10.00.	Initials:
---------------------	-----------------	-----------

# Coffin Recording Sheet

Site Code

Context

**Outer Coffin**

Sample Ret.

OR200

790

Recording Date ..... 16/2/01 .....

Associated Numbers .....

Condition .....

Dep. Plate

Legible

Inscription

Fabric lead       ormolou       brass       tin plated pewter       gilt tin   
 iron       silvered tin       enamelled       other .....      Sample Ret.

**Shape of dep. plate**

square       rectangle       shield       tapered       lozenge   
 cartouche       oval       other .....

**Upholstery**

colour .....      shoddy       velvet       other .....      Sample Ret.

**Construction**

butt joint       mitred       pitched       other .....

Grip plate       Fabric = ormolou       brass       tin plated pewter       gilt tin   
 iron       silvered tin       enamelled       other .....      Sample Ret.

Grip       Fabric = ormolou       brass       iron       X (      Sample Ret.

Design      swag of rose       horseshoe       cherub's head       ①      plain   
 other .....

Grip bolts       Corner bolts       Type =      gilt brass       brass       iron   
 other .....      Sample Ret.

Lid motifs       other .....

Escutcheons       other .....

Upholstery nails       brass       gilt brass       silvered brass       iron       enamelled   
 other .....      Sample Ret.

Fixings       panel nails       screws       hinges       lace       Sample Ret.

Timber type .....      Sample Ret.

**Interpretation / Comments**

.....  
 .....

db

SITE 02200	COFFIN RECORD SHEET	CONTEXT NO. 791
Trench:	Additional sheets: YES x 1	Treatment: WTAU
Site sub-div: CRYPT BAHT	Grave fills	→ NECROP.
Plan no: 7.	Grave cut:	Findings None <del>YAM</del>
Section no:	Skeleton:	Breastplate Grip x 2.
Co-ordinates:	Matrix location: U/L 480.	Hinge Bracket
Levels	Preservation: Pb - GOOD. OTHER WOOD - FRAGS ONLY	Fixing nails Shroud pins
Slide No.	Neg No:	Fabric Other finds

Description Pb Infant Coffin  
soldered.

Discussion

Shape, dimensions and distinguishing characteristics

Inscription = -

LID

Master  
Alfred Bailey

HEAD

Died 16 Jan 9

1829

BASE

Aged 13 Months

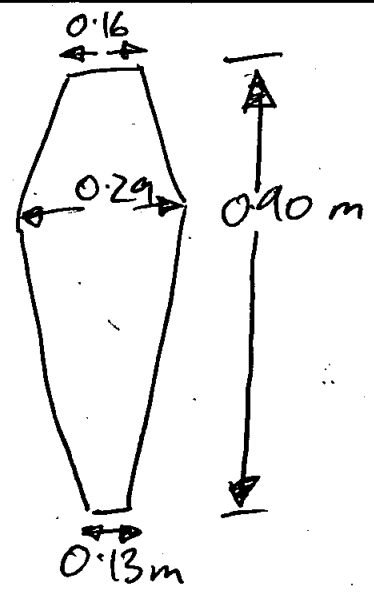

DEPTH: 0.28m

Recorder: <i>Am</i>	Date: 25. 10. 80.	Initials:
---------------------	-------------------	-----------

# Coffin Recording Sheet

Site Code

Context

**Outer Coffin**

Sample Ret.

OKR00

791

Recording Date ..... 25/10 .....

Associated Numbers .....

Condition .....

Dep. Plate

Legible

Inscription

Fabric lead  ormolou  brass  tin plated pewter  gilt tin   
iron  silvered tin  enamelled  other ..... Sample Ret.

**Shape of dep. plate**

square  rectangle  shield  tapered  lozenge   
cartouche  oval  other .....

**Upholstery**

colour ..... shoddy  velvet  other ..... Sample Ret.

**Construction**

butt joint  mitred  pitched  other .....

**Grip plate**  Fabric = ormolou  brass  tin plated pewter  gilt tin   
iron  silvered tin  enamelled  other ..... *fraggs on rev. of grip.* Sample Ret.

**Grip**  Fabric = ormolou  brass  iron  *x 2 infant ①5* Sample Ret.

**Design** swag of rose  horseshoe  cherub's head  plain   
other ..... *↔ = 0.09 ↓ = 0.04*

**Grip bolts**  **Corner bolts**  **Type =** gilt brass  brass  iron

other ..... Sample Ret.

**Lid motifs**  other ..... Sample Ret.

**Escutcheons**  other ..... Sample Ret.

**Upholstery nails**  brass  gilt brass  silvered brass  iron  enamelled   
other ..... Sample Ret.

**Fixings**  panel nails  screws  hinges  lace  Sample Ret.

**Timber type** ..... Sample Ret.

**Interpretation / Comments**

.....  
.....



db

SITE OLR00.	COFFIN RECORD SHEET	CONTEXT NO. 792
Trench:	Additional sheets:	Treatment: INTACT → NECRP.
Site sub-div: BLK 4 BAN 4	Grave fills	Finds None
Plan no: 7.	Grave cut:	
Section no:	Skeleton:	Breastplate Grip x3.
Co-ordinates:	Matrix location: U/L 481	Hinge Bracket
Levels	Preservation: Pb-GOOD. OUTER WOOD NEGLIGIBLE	Fixing nails Shroud pins
Slide No.	Neg No:	Fabric Other finds

Description Pb Coffin - Infant.  
SOLID.

Discussion

Shape, dimensions and distinguishing characteristics

Inscription: -  
Master ~~Emerson~~  
Emerson Archer  
Died 2nd Nov<sup>r</sup>  
1825  
Aged 12 Months

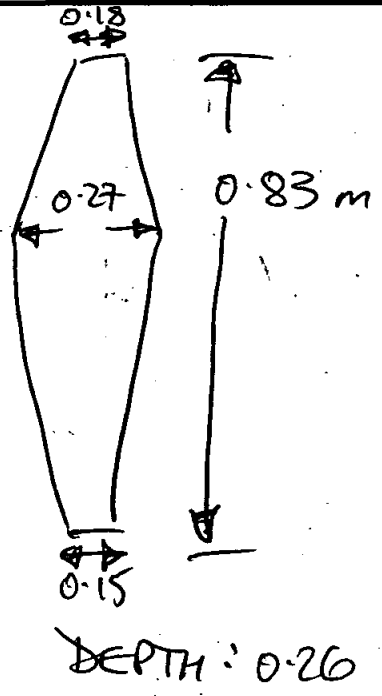

LID

HEAD

BASE

Recorder: Pm	Date: 25.10.00	Initials:
-----------------	-------------------	-----------

# Coffin Recording Sheet

Site Code

Context

**Outer Coffin**

Sample Ret.

OLR00

792

Recording Date ..... 25/10 .....

Associated Numbers .....

Condition .....

Dep. Plate

Legible

Inscription

Fabric lead  ormolou  brass  tin plated pewter  gilt tin   
 iron  silvered tin  enamelled  other ..... Sample Ret.

**Shape of dep. plate**

square  rectangle  shield  tapered  lozenge   
 cartouche  oval  other .....

**Upholstery**

colour ..... shoddy  velvet  other ..... Sample Ret.

**Construction**

butt joint  mitred  pitched  other .....

**Grip plate**  Fabric = ormolou  brass  tin plated pewter  gilt tin   
 iron  silvered tin  enamelled  other ..... Sample Ret.

**Grip**  Fabric = ormolou  brass  iron  x3  
*infant* Sample Ret.

**Design** swag of rose  horseshoe  cherub's head  plain   
 other ..... *too badly worn to id.*  $\leftarrow = 0.09$   $\downarrow = 0.04$

**Grip bolts**  **Corner bolts**  Type = gilt brass  brass  iron   
 other ..... Sample Ret.

**Lid motifs**  other ..... Sample Ret.

**Escutcheons**  other ..... Sample Ret.

**Upholstery nails**  brass  gilt brass  silvered brass  iron  enamelled   
 other ..... Sample Ret.

**Fixings**  panel nails  screws  hinges  lace  Sample Ret.

**Timber type** ..... Sample Ret.

**Interpretation / Comments**

.....  
 .....

db

SITE		COFFIN RECORD SHEET		CONTEXT NO.	
02100				793	
Trench:		Additional sheets:		Treatment:	
Site sub-div: <i>CRAT BAY 4</i>		Grave fills		<i>INTACT</i> → <i>NECROP.</i>	
Plan no: <i>7.</i>		Grave cut:		Finds	
Section no:		Skeleton:		None	
Co-ordinates:		Matrix location:		Breastplate <i>X/</i>	
Levels		Preservation:		Grip	
Slide No.		Neg No:		Hinge	
				Bracket	
				Fixing nails	
				Shroud pins	
				Fabric	
				Other finds	

Description *Pb Coffin - Infant*  
*Soldered*

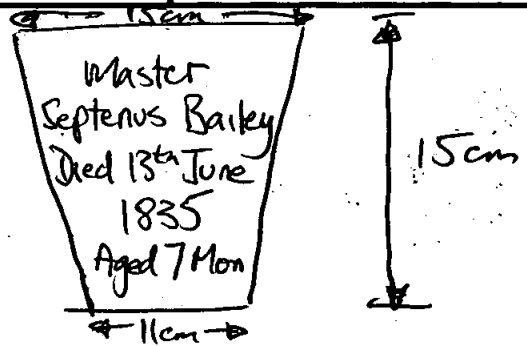

Discussion

Shape, dimensions and distinguishing characteristics

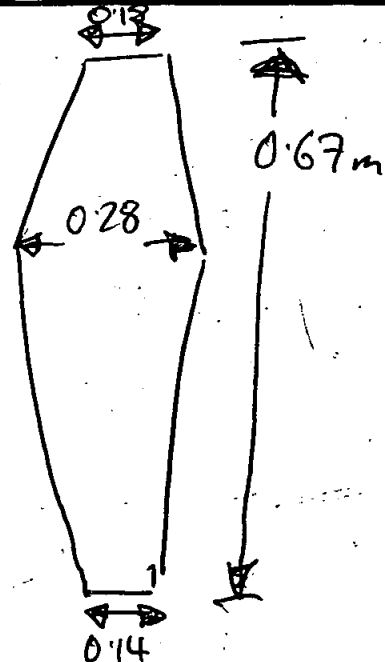
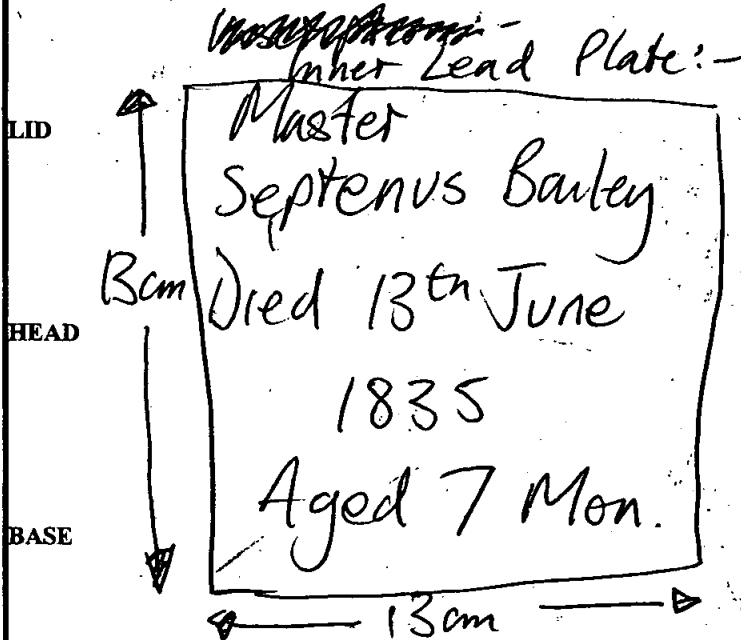

DEPTH = 0.22m.

Recorder: <i>Tm</i>	Date: <i>25.10.00</i>	Initials:
---------------------	-----------------------	-----------

# Coffin Recording Sheet

Site Code

Context

OLR00

793

Outer Coffin

Sample Ret.

Recording Date ..... 25/10

Associated Numbers .....

Condition ..... *A*

Dep. Plate

Legible

Inscription "Master / ~~Sept~~<sup>24</sup> Bailey / Died 13<sup>th</sup> June / 1835 / Aged 7 Mon<sup>s</sup>"

Fabric lead  ormolou  brass  tin plated pewter  gilt tin   
 iron  silvered tin  enamelled  other ..... Sample Ret.

Shape of dep. plate

square  rectangle  shield  *infant*  
 cartouche  oval  other ..... tapered  lozenge   
*no match - new type.*

Upholstery

colour ..... shoddy  velvet  other *boize on rev.* Sample Ret.

Construction

butt joint  mitred  pitched  other .....

Grip plate  Fabric = ormolou  brass  tin plated pewter  gilt tin   
 iron  silvered tin  enamelled  other ..... Sample Ret.

Grip  Fabric = ormolou  brass  iron  Sample Ret.

Design swag of rose  horseshoe  cherub's head  plain   
 other .....

Grip bolts  Corner bolts  Type = gilt brass  brass  iron   
 other ..... Sample Ret.

Lid motifs  other ..... Sample Ret.

Escutcheons  other ..... Sample Ret.

Upholstery nails  brass  gilt brass  silvered brass  iron  enamelled   
 other ..... Sample Ret.

Fixings  panel nails  screws  hinges  lace  Sample Ret.

Timber type ..... Sample Ret.

Interpretation / Comments

.....  
 .....

db

SITE	COFFIN RECORD SHEET	CONTEXT NO.
01/100		728
Trench:	Additional sheets: <i>MFD x 2</i>	Treatment: <i>INTACT</i>
Site sub-div: <i>CAMP BAY 4</i>	Grave fills	<i>→ NECROP.</i>
Plan no: <i>7</i>	Grave cut:	Finds
Section no:	Skeleton:	None
Co-ordinates:	Matrix location:	Breastplate <input checked="" type="checkbox"/>
Levels	Preservation: <i>Pb - Good</i> <i>Outer wood - FRAGS</i>	Grip <input checked="" type="checkbox"/>
Slide No.	Neg No:	Hinge
		Bracket
		Fixing nails
		Shroud pins
		Fabric
		Other finds

Description *Pb Coffin - Infant*  
*Saddled.* **BREAST PLATE**

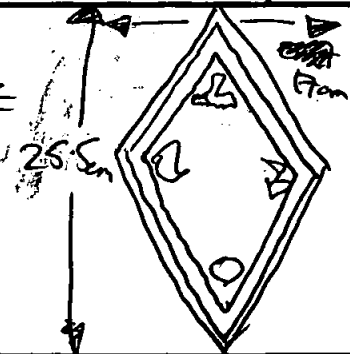

Discussion *Miss Ellen Lycett*  
*Died 6<sup>th</sup> March 1827*  
*Aged 5 Years*  
*2 Mon<sup>s</sup>*

Shape, dimensions and distinguishing characteristics

*Inscription: -*

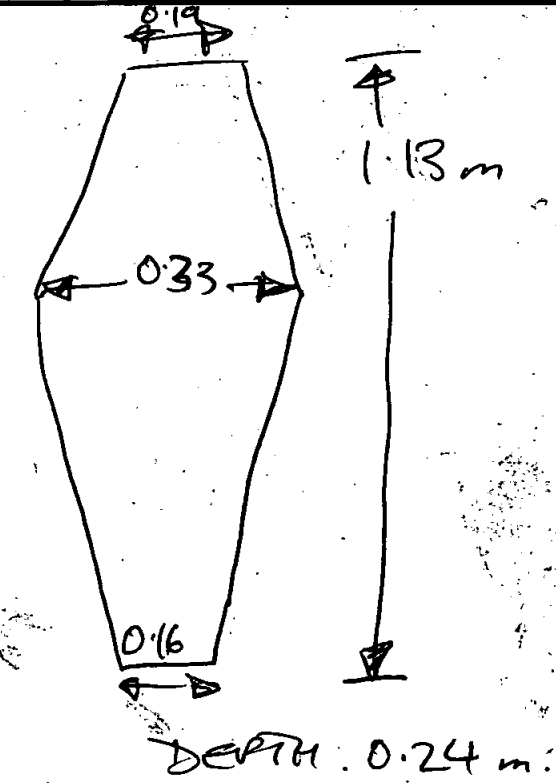

LID

HEAD

BASE

*Miss Ellen Lycett*  
*Died 6<sup>th</sup> March 1827*  
*Aged 5 Years*  
*2 Mon<sup>s</sup>*

DEPTH: 0.24 m.

Recorder: *B* Date: *25.10.80* Initials:

# Coffin Recording Sheet

Site Code

Context

**Outer Coffin**

Sample Ret.

OR200

794

Recording Date ..... 25/10 .....

Associated Numbers .....

Condition ..... 2 .....

Dep. Plate

Legible

Inscription "Miss Ellen Lyceet / Died 6<sup>th</sup> March / 1827 / Aged 5 years & 2 Months"

Fabric lead  ormolou  brass  tin plated pewter  gilt tin   
 iron  silvered tin  enamelled  other ..... Sample Ret.

**Shape of dep. plate**

square  rectangle  shield  tapered  lozenge   
 cartouche  oval  other .....

**Upholstery**

colour ..... shoddy  velvet  other ..... Sample Ret.

**Construction**

butt joint  mitred  pitched  other .....

Grip plate  Fabric = ormolou  brass  tin plated pewter  flags-unid. gilt tin   
 iron  silvered tin  enamelled  other ..... Sample Ret.

Grip  Fabric = ormolou  brass  iron  x2 too badly conc to id. Sample Ret.   
 Design swag of rose  horseshoe  cherub's head  plain

other .....

Grip bolts  Corner bolts  Type = gilt brass  brass  iron

other ..... Sample Ret.

Lid motifs  other ..... Sample Ret.

Escutcheons  other ..... Sample Ret.

Upholstery nails  brass  gilt brass  silvered brass  iron  enamelled   
 other ..... Sample Ret.

Fixings  panel nails  screws  hinges  lace  Sample Ret.

Timber type ..... Sample Ret.

**Interpretation / Comments**

.....  
 .....

SITE <i>OLR 00</i>	COFFIN RECORD SHEET	CONTEXT NO. <i>795</i>
Trench:	Additional sheets:	Treatment: <i>B.C.</i>
Site sub-div: <i>NC</i>	Grave fills <i>—</i>	
Plan no: <i>3</i>	Grave cut: <i>—</i>	Finds None <input checked="" type="checkbox"/>
Section no:	Skeleton: <i>761</i>	Breastplate Grip
Co-ordinates:	Matrix location: <del>760</del> <i>761</i> <del>761</del> <i>795</i> <i>796</i>	Hinge Bracket
Levels	Preservation: <i>FAIR.</i>	Fixing nails Shroud pins
Slide No.	Neg No:	Fabric Other finds
Description <i>E-W Adult burial. Bone retrieval rate fairly poor due to burial being machined out because of 2.5m section.</i>		
Discussion		
Shape, dimensions and distinguishing characteristics		
Recorder: <i>D Helm</i> Date: <i>23.10.00</i> Initials:		

SITE	COFFIN RECORD SHEET	CONTEXT NO.
OLR 00		796
Trench:	Additional sheets:	Treatment: B.C.
Site sub-div: NC	Grave fills /	
Plan no: 3	Grave cut: /	Finds None <input checked="" type="checkbox"/>
Section no:	Skeleton: 796	Breastplate Grip
Co-ordinates:	Matrix location: 761 795 796	Hinge Bracket
Levels	Preservation: FAIR.	Fixing nails Shroud pins
Slide No.	Neg No:	Fabric Other finds
<b>Description</b> E-W Adult burial. Collection quality fairly poor due to burial being machined out because of 2.5m section.		
<b>Discussion</b>		
<b>Shape, dimensions and distinguishing characteristics</b>  LID  HEAD  BASE		
Recorder: D. Hall	Date: 23.10.08.	Initials:



SITE <i>OLROO</i>	CONTEXT RECORD		Context No. <i>797</i>
Trench	Additional Sheets:		Type <i>STRUCT</i>
Site sub-div	Context Type: <i>Deposit / Cut / Structure</i>		Check Lists:
Structure No.	Overlain by:	DEPOSIT: 1.compaction 2.colour 3.composition 4.inclusions 5.thickness 6.extent 7.comments 8.method & conditions	
Plan No. <i>6</i>	Abutted by:		
Section No.	Cut by:		
Co-Ordinates	Filled by:		
Level	Same as:	CUT: 1.shape in plan 2.base/sides/top profile 3.dimension and depth 4.sketch 5.truncation 6.fill nos 7.other comments	
Slide No.	Part of:		
Neg No.	Consists of:	MASONRY: 1.materials 2.size of bricks etc 3.finish of stones 4.coursing/bond 5.form 6.faces 7.bond 8.dimensions as found 9.other comments	
Matrix location	Overlies:		
Relationships uncertain	Butts:		
Description (See check lists):	Cuts:		Fill of:
<p><i>Series of brick drains post dating church construction, but contemporary if you see what I mean. Fairly modern may be over circular <sup>superior</sup> well run off c.60m wide &amp; (c.35m wide internally) over 1.5m deep. Drain runs N to church corner and W across site.</i></p>		<p>STRATIGRAPHIC MATRIX</p> <p>this context is</p>	
		<p>Interpretation/Discussion:</p>	
<p>Finds (tick): None <input type="checkbox"/> Pot <input type="checkbox"/> Bone <input type="checkbox"/> Flint <input type="checkbox"/> Stone <input type="checkbox"/> Burnt stone <input type="checkbox"/> Glass <input type="checkbox"/> Metal <input type="checkbox"/> CBM <input type="checkbox"/> Wood <input type="checkbox"/> Leather <input type="checkbox"/></p>			
<p>Δ Small Finds</p>	<p>Recorder <i>[Signature]</i></p>		
<p>◇ Samples</p>	<p>Date <i>24/10/00</i></p>		
<p>△ Building Materials</p>	<p>Initials</p>		

SITE		COFFIN RECORD SHEET		CONTEXT NO:	
OLP00				798	
Trench:		Additional sheets:		Treatment:	
Site sub-div: S.C.		Grave fills		B.C.	
Plan no: 6		Grave cut: BRICK GRAVE 799		Finds	
Section no:		Skeleton: 798		None	
Co-ordinates:		Matrix location: <del>798</del> 798 1 <del>799</del> 800		Breastplate	
Levels		Preservation: <del>1/40</del> FAIR		Grip	
Slide No.		Neg No:		Hinge <input checked="" type="checkbox"/>	
Description				Bracket	
Discussion				Fixing nails	
Shape, dimensions and distinguishing characteristics				Shroud pins	
LID				Fabric	
HEAD				Other finds	
BASE					
Recorder: Jhu		Date: 24/10/00		Initials:	

**Outer Coffin**

Sample Ret.

Site Code

Context

Recording Date ..... 21/2/01 .....

OHROO

798

Associated Numbers .....

Condition .....

Dep. Plate

Legible

Inscription

Fabric lead  ormolou  brass  tin plated pewter  gilt tin   
 iron  silvered tin  enamelled  other ..... Sample Ret.

**Shape of dep. plate**

square  rectangle  shield  tapered  lozenge   
 cartouche  oval  other .....

**Upholstery**

colour ..... shoddy  velvet  other ..... Sample Ret.

**Construction** butt joint  mitred  pitched  other .....

**Grip plate**  Fabric = ormolou  brass  tin plated pewter  gilt tin   
 iron  *not enough to id* silvered tin  enamelled  other ..... Sample Ret.

**Grip**  Fabric = ormolou  brass  iron  *2x infants* Sample Ret.

**Design** swag of rose  horseshoe  cherub's head  *①'s* plain   
 other ..... *↔ 0.12 ↓ 0.045*

**Grip bolts**  **Corner bolts**  **Type =** gilt brass  brass  iron   
 other ..... Sample Ret.

**Lid motifs**  other ..... Sample Ret.

**Escutcheons**  other ..... Sample Ret.

**Upholstery** *studs*  brass  gilt brass  silvered brass  iron  enamelled   
 other ..... *o* Sample Ret.

**Fixings**  panel nails  screws  hinges  lace  Sample Ret.

**Timber type** ..... Sample Ret.

**Interpretation / Comments**

.....  
 .....

SITE		CONTEXT RECORD		Context No.
0LR00		Additional Sheets:		799
Trench	Context Type: Deposit / Cut / <u>Structure</u>			Check Lists:
Site sub-div	SC	Overlain by:	DEPOSIT:	
Structure No.		Abuted by:	1.compaction 2.colour 3.composition 4.inclusions 5.thickness 6.extent 7.comments 8.method & conditions	
Plan No.	G	Cut by:	CUT:	
Section No.		Filled by: BODIES 798 & 800 ZINC COFFIN	1.shape in plan 2.base/sides/top profile 3.dimension and depth 4.sketch 5.truncation 6.fill nos 7.other comments	
Co-Ordinates		Same as:	MASONRY:	
Level		Part of:	1.materials 2.size of bricks etc 3.finish of stones 4.coursing/bond 5.form 6.faces 7.bond 8.dimensions as found 9.other comments	
Slide No.		Consists of:		
Neg No.		Overlies:		
Matrix location		Butts:		
		Cuts:		
		Fill of:		
		Relationships uncertain		
Description (See check lists):			STRATIGRAPHIC MATRIX	
Back grave over 3.5m deep. Chamber ab base 0.60m deep 0.90m wide, coffin shaped with zinc coffin 800 within. Limestone slab capped upper. Then another 0.60m of brick (6 courses) and limestone cap. with body (798) within. Then bricks to surface which are badged. Two courses wide at base. Length			this context is <pre>                     graph TD                         A[ ] --- B[799]                         B --- C[ ]                         B --- D[ ]                         B --- E[ ]                     </pre>	
			Interpretation/Discussion: unknown as edge of excavation.	
Finds (tick): None <input type="checkbox"/> Pot <input type="checkbox"/> Bone <input type="checkbox"/> Flint <input type="checkbox"/> Stone <input type="checkbox"/> Burnt stone <input type="checkbox"/> Glass <input type="checkbox"/> Metal <input type="checkbox"/> CBM <input type="checkbox"/> Wood <input type="checkbox"/> Leather <input type="checkbox"/>				
Δ Small Finds ◇ Samples ▽ Building Materials			Recorder <i>[Signature]</i> Date 24/10/00 Initials	

SITE OLR00	COFFIN RECORD SHEET	CONTEXT NO. 800
Trench:	Additional sheets:	Treatment:
Site sub-div: S.C.	Grave fills	BONES <u>NO.</u> COLLECTED
Plan no: 6	Grave cut:	Finds None
Section no:	Skeleton: 800	Breastplate Grip
Co-ordinates:	Matrix location: 798 800	Hinge Bracket
Levels	Preservation: 799	Fixing nails Shroud pins
Slide No.	Neg No:	Fabric Other finds
<p><b>Description</b> ZINC? coffin in brick grave 799 below body 798 edge of excavation. Adult sized. Left</p> <p><b>Discussion</b> in situ as edge of excavation.</p>		
<p><b>Shape, dimensions and distinguishing characteristics</b></p> <p>LID</p> <p>HEAD</p> <p>BASE</p>		
Recorder: <i>JR</i>	Date: 24/10/00	Initials:

SITE	COFFIN RECORD SHEET	CONTEXT NO.
02200		801
Trench:	Additional sheets:	Treatment:
Site sub-div: SC	Grave fills	BONE NOT COLLECTED
Plan no: G	Grave cut:	Finds
Section no:	Skeleton: 801	None
Co-ordinates:	Matrix location: 801 1 802	Breastplate
Levels	Preservation:	Grip
Slide No.	Neg No:	Hinge
Description		Bracket
E-W Adult G Edge of site head removed as placed atop of coffin which was left in situ.		Fixing nails
Discussion		Shroud pins
Shape, dimensions and distinguishing characteristics		Fabric
Recorder: JK		Other finds
Date: 24/10/00		

SITE	COFFIN RECORD SHEET	CONTEXT NO.
04/200		802
Trench:	Additional sheets: 463 x 1	Treatment:
Site sub-div: 5C	Grave fills	BUNG COLLECTOR
Plan no: 6	Grave cut:	Finds
		None
Section no:	Skeleton: 802	Breastplate
		Grip <input checked="" type="checkbox"/>
Co-ordinates:	Matrix location: 801 802	Hinge
		Bracket
Levels	Preservation:	Fixing nails
		Shroud pins
Slide No.	Neg No:	Fabric
		Other finds
<p>Description</p> <p>6-W Adult 6 edge of site only head and upper torso recovered. as too deep into section and too deep in the ground.</p> <p>Discussion</p>		
<p>Shape, dimensions and distinguishing characteristics</p> <p>LID</p> <p>HEAD</p> <p>BASE</p>		
Recorder: JH	Date: 24/10/00	Initials:

# Coffin Recording Sheet

Site Code

Context

**Outer Coffin**

Sample Ret.

01R00

802

Recording Date ..... 13/2/01 .....

Associated Numbers .....

Condition .....

Dep. Plate

Legible

Inscription

Fabric lead  ormolou  brass  tin plated pewter  gilt tin   
 iron  silvered tin  enamelled  other ..... Sample Ret.

**Shape of dep. plate**

square  rectangle  shield  tapered  lozenge   
 cartouche  oval  other .....

**Upholstery**

colour ..... shoddy  velvet  other ..... Sample Ret.

**Construction**

butt joint  mitred  pitched  other .....

Grip plate  Fabric = ormolou  brass  tin plated pewter  gilt tin   
 iron  silvered tin  enamelled  other ..... Sample Ret.

Grip  Fabric = ormolou  brass  iron  x2 Sample Ret.

Design swag of rose  horseshoe  cherub's head  ④'s plain   
 other .....

Grip bolts  Corner bolts  Type = gilt brass  brass  iron   
 other ..... Sample Ret.

Lid motifs  other ..... Sample Ret.

Escutcheons  other ..... Sample Ret.

Upholstery nails  brass  gilt brass  silvered brass  iron  enamelled   
 other ..... Sample Ret.

Fixings  panel nails  screws  hinges  lace  Sample Ret.

Timber type ..... Sample Ret.

**Interpretation / Comments**

.....  
 .....



SITE <i>0LR00</i>	COFFIN RECORD SHEET	CONTEXT NO. <i>803</i>
Trench:	Additional sheets:	Treatment: <i>BONES COLLECTED</i>
Site sub-div: <i>SC</i>	Grave fills	
Plan no: <i>6</i>	Grave cut: <i>VAULT 496 Above</i>	Finds None
Section no:	Skeleton: <i>803</i>	Breastplate Grip
Co-ordinates:	Matrix location: <i>600   803   804</i>	Hinge Bracket
Levels	Preservation: <i>GOOD</i>	Fixing nails Shroud pins
Slide No.	Neg No:	Fabric Other finds
Description <i>6-0W Adult v. edge of site (East) Moulded cub as deep section and mixed with 804 &amp; 805</i> Discussion <i>only upper torso &amp; head v. smashed.</i>		
Shape, dimensions and distinguishing characteristics  LID  HEAD  BASE		
Recorder: <i>[Signature]</i>	Date: <i>25/10/00</i>	Initials:

SITE	COFFIN RECORD SHEET	CONTEXT NO.
04/200		804
Trench:	Additional sheets:	Treatment:
Site sub-div: 5C	Grave fills	B.C.
Plan no: 6	Grave cut: VAULT 496 OVER 302165	Finds None
Section no:	Skeleton: 804	Breastplate Grip
Co-ordinates:	Matrix location: 803 804	Hinge Bracket
Levels	Preservation: 805 GOOD	Fixing nails Shroud pins
Slide No.	Neg No:	Fabric Other finds
<p>Description</p> <p>6-W Adult East edge of site. V. deep machined cut &amp; mixed with 803 &amp; 805</p>		
<p>Discussion</p>		
<p>Shape, dimensions and distinguishing characteristics</p> <p>LID</p> <p>HEAD</p> <p>BASE</p>		
Recorder: JW	Date: 25/10/00	Initials:

SITE <u>04200</u>		COFFIN RECORD SHEET		CONTEXT NO. <u>805</u>	
Trench:		Additional sheets:		Treatment:	
Site sub-div: <u>SC</u>		Grave fills:		<u>B.C.</u>	
Plan no: <u>6</u>		Grave cut: <u>BELOW VAULT 496</u>		Finds	
Section no:		Skeleton: <u>805</u>		None	
Co-ordinates:		Matrix location: <u>804</u> <u>805</u>		Breastplate	
Levels:		Preservation: <u>Good</u>		Grip	
Slide No.:		Neg No.:		Hinge	
Description		Discussion		Bracket	
<p><u>S-W Adult</u> <u>Excav edge of site at base of deep</u> <u>section so machined out only upper torso retrieved</u></p>		<p><u>very mixed with 803 &amp; 804</u></p>		Fixing nails	
Shape, dimensions and distinguishing characteristics				Shroud pins	
LID				Fabric	
HEAD				Other finds	
BASE					
Recorder: <u>JH</u>		Date: <u>25/10/00</u>		Initials:	

SITE	COFFIN RECORD SHEET	CONTEXT NO.
0-2200	Additional sheets:	806
Trench:	Grave fills	Treatment: B.C.
Site sub-div: SC	Grave cut:	Finds
Plan no: 6	Skeleton:	None
Section no:	806	Breastplate FRAGS Grip ✓
Co-ordinates:	Matrix location: 806	Hinge
Levels	Preservation: Good	Bracket
Slide No.	Neg No:	Fixing nails
		Shroud pins
		Fabric
		Other finds
<p>Description E-W slabs ab the side of brick grave 1251 appears later than brick grave.</p>		
Discussion		
<p>Shape, dimensions and distinguishing characteristics</p> <p>LID</p> <p>HEAD</p> <p>BASE</p>		
Recorder: JH	Date: 26/10/00	Initials:

db

SITE 02200		COFFIN RECORD SHEET		CONTEXT NO. 807	
Trench:		Additional sheets: YES x 2.		Treatment:	
Site sub-div: SC		Grave fills		BC	
Plan no: 6		Grave cut: BRICK GRAVE 239		Finds	
Section no:		Skeleton: 807		None	
Co-ordinates:		Matrix location: 807 1 808		Breastplate ✓	
Levels		Preservation: Poor		Grip	
Slide No.		Neg No:		Hinge	
Description		6-w Adult in brick grave [239] in a lead coffin, named. v DNA taken. Machine damaged so		Bracket	
Discussion		dimension unknown.		Fixing nails	
Shape, dimensions and distinguishing characteristics				Shroud pins	
LID				Fabric	
HEAD				Other finds	
BASE					
Recorder: Jha		Date: 26/10/00		Initials:	

**Outer Coffin**

Sample Ret.

Site Code

Context

Recording Date ..... 27/10 .....

OH200

807

Associated Numbers .....

Condition ..... 3 .....

Dep. Plate

Legible

Inscription "Mr / Charles Triggs / Died Jan<sup>y</sup> 10<sup>th</sup> / 1778 / Aged 75

Fabric lead  ormolou  brass  tin plated pewter  gilt tin   
 iron  silvered tin  enamelled  other ..... Sample Ret.

**Shape of dep. plate**

square  rectangle  shield  tapered  lozenge   
 cartouche  oval  other ..... *new type.*

**Upholstery**

colour ..... shoddy  velvet  other ..... Sample Ret.

**Construction**

butt joint  mitred  pitched  other .....

Grip plate  Fabric = ormolou  brass  tin plated pewter  gilt tin   
 iron  silvered tin  enamelled  other ..... Sample Ret.

Grip  Fabric = ormolou  brass  iron  Sample Ret.

Design swag of rose  horseshoe  cherub's head  plain   
 other .....

Grip bolts  Corner bolts  Type = gilt brass  brass  iron   
 other ..... Sample Ret.

Lid motifs  other ..... Sample Ret.

Escutcheons  other ..... Sample Ret.

Upholstery nails  brass  gilt brass  silvered brass  iron  enamelled   
 other ..... Sample Ret.

Fixings  panel nails  screws  hinges  lace  Sample Ret.

Timber type ..... Sample Ret.

**Interpretation / Comments**

.....  
 .....

SITE	COFFIN RECORD SHEET	CONTEXT NO.
2200		808
Trench:	Additional sheets:	Treatment:
Site sub-div: 3C	Grave fills	BC
Plan no: 6	Grave cut: BRICK GRAVE 239	Finds None
Section no:	Skeleton: 808 ↓	Breastplate Grip
Co-ordinates:	Matrix location: 807 ↓ 808 ↓	Hinge Bracket
Levels	Preservation: 809 GOOD	Fixing nails Shroud pins
Slide No.	Neg No:	Fabric Other finds
<p><b>Description</b> 6-w Adult in lead coffin 1.8cm long 0.55m wide. In brick grave 239</p> <p><b>Discussion</b></p>		
<p><b>Shape, dimensions and distinguishing characteristics</b></p> <p>LID</p> <p>HEAD</p> <p>BASE</p>		
Recorder: JHJ	Date: 26/10/02	Initials:

**Outer Coffin**

Sample Ret.

Site Code

Context

Recording Date ..... *21/2/01* .....

*OH200*

*808*

Associated Numbers .....

Condition ..... *?* .....

Dep. Plate  *?*

Legible  *NO*

Inscription *3 x frogs, poss. dep. plate, Fe w/ black enamel & partial chiselles.*

Fabric lead  ormolou  brass  tin plated pewter  gilt tin   
 iron  silvered tin  enamelled  other ..... Sample Ret.

**Shape of dep. plate**

square  rectangle  shield  tapered  lozenge   
 cartouche  oval  other .....

**Upholstery**

colour ..... shoddy  velvet  other ..... Sample Ret.

**Construction**

butt joint  mitred  pitched  other .....

**Grip plate**

Fabric = ormolou  brass  tin plated pewter  gilt tin   
*Frogs on rev of grip-wood*  
 iron  silvered tin  enamelled  other ..... Sample Ret.

**Grip**

Fabric = ormolou  brass  iron  Sample Ret.

**Design**

swag of rose  horseshoe  cherub's head  *1 x* **3Q** plain

other .....

**Grip bolts**

**Corner bolts**  Type = gilt brass  brass  iron

other ..... Sample Ret.

**Lid motifs**

other ..... Sample Ret.

**Escutcheons**

other ..... Sample Ret.

**Upholstery nails**

brass  gilt brass  silvered brass  iron  enamelled

other ..... Sample Ret.

**Fixings**

panel nails  screws  hinges  lace  Sample Ret.

**Timber type**

..... Sample Ret.

**Interpretation / Comments**

.....  
 .....



SITE <i>OL200</i>	COFFIN RECORD SHEET	CONTEXT NO. <i>809</i>
Trench:	Additional sheets:	Treatment: <i>B.C.</i>
Site sub-div: <i>SC</i>	Grave fills	
Plan no: <i>6</i>	Grave cut: <i>In back grave 239</i>	Finds None
Section no:	Skeleton: <i>809</i>	Breastplate Grip
Co-ordinates:	Matrix location: <i>808</i> <i>1</i> <i>809</i>	Hinge Bracket
Levels	Preservation: <i>FAIR</i>	Fixing nails Shroud pins
Slide No.	Neg No:	Fabric Other finds

Description *6-w Adult in back grave 239 Machine damaged.*

Discussion

Shape, dimensions and distinguishing characteristics

LID

HEAD

BASE

Recorder: <i>JH</i>	Date: <i>26/10/00</i>	Initials:
---------------------	-----------------------	-----------

**Outer Coffin**

Sample Ret.

Site Code

Context

oh200

809

Recording Date ..... 16/2/01 .....

Associated Numbers .....

Condition .....

Dep. Plate

Legible

Inscription

**Fabric lead**  ormolou  brass  tin plated pewter  gilt tin   
 iron  silvered tin  enamelled  other ..... Sample Ret.

**Shape of dep. plate**

square  rectangle  shield  tapered  lozenge   
 cartouche  oval  other .....

**Upholstery**

colour ..... shoddy  velvet  other ..... Sample Ret.

**Construction** butt joint  mitred  pitched  other .....

**Grip plate**  **Fabric** = ormolou  brass  tin plated pewter  gilt tin   
 iron  *knop on elev. of grip - unid* silvered tin  enamelled  other ..... Sample Ret.

**Grip**  **Fabric** = ormolou  brass  iron  *x1* Sample Ret.

**Design** swag of rose  horseshoe  cherub's head  *(1)* plain   
 other .....

**Grip bolts**  **Corner bolts**  **Type =** gilt brass  brass  iron   
 other ..... Sample Ret.

**Lid motifs**  other ..... Sample Ret.

**Escutcheons**  other ..... Sample Ret.

**Upholstery nails**  brass  gilt brass  silvered brass  iron  enamelled   
 other ..... Sample Ret.

**Fixings**  panel nails  screws  hinges  lace  Sample Ret.

**Timber type** ..... Sample Ret.

**Interpretation / Comments**

.....  
 .....

SITE <del>870</del> 04200		COFFIN RECORD SHEET	CONTEXT NO. 810
Trench:	Additional sheets:	Treatment: B.C.	
Site sub-div: SC	Grave fills:		
Plan no: 6	Grave cut:	Finds None	
Section no:	Skeleton: 810 1	Breastplate Grip	
Co-ordinates:	Matrix location: 815	Hinge Bracket	
Levels:	Preservation: v. poor	Fixing nails Shroud pins	
Slide No.:	Neg No.:	Fabric Other finds	
<b>Description</b> G-W Adult v. crushed by heavy plumb tracking up & down in South church yard.			
<b>Discussion</b>			
<b>Shape, dimensions and distinguishing characteristics</b>			
<b>LID</b>			
<b>HEAD</b>			
<b>BASE</b>			
Recorder: JW	Date: 26/10/00	Initials:	

SITE 02200		COFFIN RECORD SHEET		CONTEXT NO. 811	
Trench:		Additional sheets:		Treatment:	
Site sub-div: SC		Grave fills		B.C.	
Plan no: 6		Grave cut:		Finds	
Section no:		Skeleton: 811		None	
Co-ordinates:		Matrix location: 811 1 812		Breastplate	
Levels:		Preservation: FAIR		Grip /	
Slide No.:		Neg No.:		Hinge	
Description		6-0 Adult		Bracket	
Discussion				Fixing nails	
Shape, dimensions and distinguishing characteristics				Shroud pins	
LID				Fabric	
HEAD				Other finds	
BASE					
Recorder: JH		Date: 25/10/00		Initials:	

**Outer Coffin**

Sample Ret.

Site Code

Context

OLR00

811

Recording Date ..... 16/2/01 .....

Associated Numbers .....

Condition .....

Dep. Plate

Legible

Inscription

Fabric lead  ormolou  brass  tin plated pewter  gilt tin   
 iron  silvered tin  enamelled  other ..... Sample Ret.

**Shape of dep. plate**

square  rectangle  shield  tapered  lozenge   
 cartouche  oval  other .....

**Upholstery**

colour ..... shoddy  velvet  other ..... Sample Ret.

**Construction**

butt joint  mitred  pitched  other .....

**Grip plate**  Fabric = ormolou  brass  tin plated pewter  gilt tin   
 iron  silvered tin  enamelled  other ..... Sample Ret.

**Grip**  Fabric = ormolou  brass  iron  Sample Ret.

**Design** swag of rose  horseshoe  cherub's head  plain   
 other ..... *+ 1 new type (black enamelled)*

**Grip bolts**  **Corner bolts**  Type = gilt brass  brass  iron

other ..... Sample Ret.

**Lid motifs**  other ..... Sample Ret.

**Escutcheons**  other ..... Sample Ret.

**Upholstery** *studs*  brass  gilt brass  silvered brass  iron  enamelled

other ..... *1 x ormolou* ..... Sample Ret.

**Fixings**  panel nails  screws  hinges  lace  Sample Ret.

**Timber type** ..... Sample Ret.

**Interpretation / Comments**

.....  
 .....

dlb

SITE <b>OLR00</b>	COFFIN RECORD SHEET	CONTEXT NO. <b>812</b>
Trench:	Additional sheets: <b>4E6 x 2.</b>	Treatment:
Site sub-div: <b>5C</b>	Grave fills	<b>B.C.</b> <b>D.N.A.</b>
Plan no: <b>6</b>	Grave cut:	Finds
Section no:	Skeleton: <b>812</b>	None
Co-ordinates:	Matrix location: <b>811</b> <b>812</b> <b>1</b>	Breastplate <input checked="" type="checkbox"/>
Levels	Preservation: <b>813</b> <b>F.A.R.</b>	Grip <input checked="" type="checkbox"/>
Slide No.	Neg No:	Hinge
		Bracket
		Fixing nails
		Shroud pins
		Fabric
		Other finds

Description **6-0 Adult D.N.A d**

Discussion

Shape, dimensions and distinguishing characteristics

LID

HEAD

BASE

Recorder: <i>[Signature]</i>	Date: <b>26/10/00</b>	Initials:
------------------------------	-----------------------	-----------

# Coffin Recording Sheet

Site Code

Context

**Outer Coffin**

Sample Ret.

OR100

812

Recording Date ..... 26/10 .....

Associated Numbers .....

Condition ..... 2 .....

Dep. Plate

Legible

Inscription "Mrs/ Mary Combes/ Died 17<sup>th</sup> April/ 1848/ Aged 78 Years"

Fabric lead       ormolou       brass       tin plated pewter       gilt tin   
 iron       silvered tin       enamelled       other .....      Sample Ret.

**Shape of dep. plate**

square       rectangle       shield       tapered       lozenge   
 cartouche       oval       other .....

**Upholstery**

colour .....      shoddy       velvet       other .....      Sample Ret.

**Construction**

butt joint       mitred       pitched       other .....

Grip plate       Fabric = ormolou       brass       tin plated pewter       gilt tin   
 iron       silvered tin       enamelled       other .....      Sample Ret.

Grip       Fabric = ormolou       brass       iron  x2      Sample Ret.

Design      swag of rose       horseshoe       cherub's head  (A) 5      plain   
 other .....

Grip bolts       Corner bolts       Type =      gilt brass       brass       iron   
 other .....      Sample Ret.

Lid motifs       other .....

Escutcheons       other .....

Upholstery nails       brass       gilt brass       silvered brass       iron       enamelled   
 other .....      Sample Ret.

Fixings       panel nails       screws       hinges       lace       Sample Ret.

Timber type .....      Sample Ret.

**Interpretation / Comments**

.....  
 .....

Top same as 762 (top)

bottom as below.

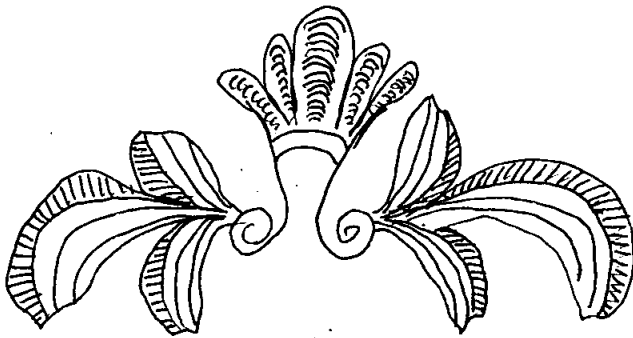

same as 618

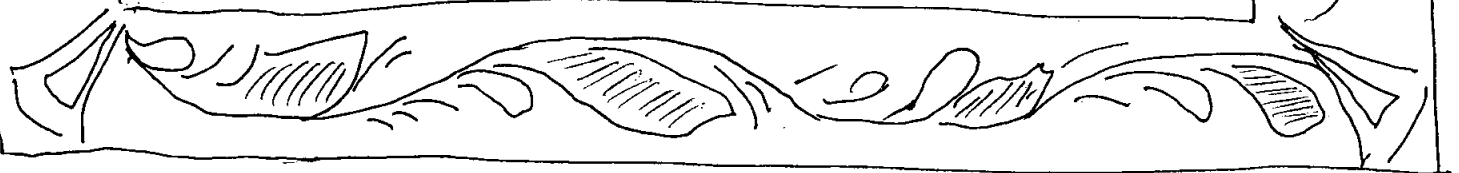



db

SITE	COFFIN RECORD SHEET		CONTEXT NO.
04200	Additional sheets: Yes x1.		813
Trench:	Grave fills	Treatment: B.C.	
Site sub-div: SC	Grave cut:	Finds	
Plan no: 6	Skeleton:	None	
Section no:	Matrix location:	Breastplate ✓ Grip ✓	
Co-ordinates:	Preservation: 812 813	Hinge	
Levels	Neg No:	Bracket	
Slide No.	814 FAIR	Fixing nails	
		Shroud pins	
		Fabric	
		Other finds	
Description			
6-w Adult, couldn't read plate.			
Discussion			
Shape, dimensions and distinguishing characteristics			
LID			
HEAD			
BASE			
Recorder: J.W.	Date: 26/10/00	Initials:	

# Coffin Recording Sheet

Site Code

Context

AR00

813

**Outer Coffin**

Sample Ret.

Recording Date ..... 27/10 .....

Associated Numbers .....

Condition .....

Dep. Plate

Legible  NO

Inscription "MR / John C .....

Fabric lead  ormolou  brass  tin plated pewter  gilt tin   
 iron  silvered tin  enamelled  other ..... Sample Ret.

**Shape of dep. plate**

square  rectangle  shield  tapered  lozenge   
 cartouche  oval  other ..... 82 w/ inner border 715  
 outer border 812.

**Upholstery**

colour ..... shoddy  velvet  other ..... Sample Ret.

**Construction**

butt joint  mitred  pitched  other .....

Grip plate  Fabric = ormolou  brass  tin plated pewter  gilt tin   
 iron  silvered tin  enamelled  other ..... Sample Ret.

Grip  Fabric = ormolou  brass  iron  Sample Ret.

Design swag of rose  horseshoe  cherub's head  plain   
 other .....

Grip bolts  Corner bolts  Type = gilt brass  brass  iron   
 other ..... Sample Ret.

Lid motifs  other ..... Sample Ret.

Escutcheons  other ..... Sample Ret.

Upholstery nails  brass  gilt brass  silvered brass  iron  enamelled   
 other ..... Sample Ret.

Fixings  panel nails  screws  hinges  lace  Sample Ret.

Timber type ..... Sample Ret.

**Interpretation / Comments**

.....  
 .....

SITE 01200	COFFIN RECORD SHEET	CONTEXT NO. <del>01200</del> 814
Trench:	Additional sheets:	Treatment:
Site sub-div: SC	Grave fills	B.C.
Plan no: 6	Grave cut:	Finds None
Section no:	Skeleton: 814	Breastplate Grip ✓
Co-ordinates:	Matrix location: 813 814	Hinge Bracket
Levels	Preservation: 816 GOOD	Fixing nails Shroud pins
Slide No.	Neg No:	Fabric Other finds
Description E-W Arch		
Discussion		
Shape, dimensions and distinguishing characteristics  LID  HEAD  BASE		
Recorder: JR	Date: 26/10/00	Initials:

SITE	COFFIN RECORD SHEET		CONTEXT NO.
04200	Additional sheets:	815	
Trench:	Grave fills	Treatment: BC	
Site sub-div: SC	Grave cut:	Finds	
Plan no: 6	Skeleton: 815	None	
Section no:	Matrix location: 810 1 815	Breastplate	
Co-ordinates:	Preservation: FAIR	Grip	
Levels	Neg No:	Hinge	
Slide No.		Bracket	
Description	E-W Adult mixed with chert	Fixing nails	
Discussion		Shroud pins	
Shape, dimensions and distinguishing characteristics		Fabric	
LID		Other finds	
HEAD			
BASE			
Recorder: J. H. W.	Date: 26/10/00	Initials:	

# Coffin Recording Sheet

Site Code

Context

**Outer Coffin**

Sample Ret.

OLR00

815

Recording Date ..... 16/2/01 .....

Associated Numbers .....

Condition .....

Dep. Plate

Legible

Inscription

Fabric lead       ormolou       brass       tin plated pewter       gilt tin   
 iron       silvered tin       enamelled       other .....      Sample Ret.

**Shape of dep. plate**

square       rectangle       shield       tapered       lozenge   
 cartouche       oval       other .....

**Upholstery**

colour .....      shoddy       velvet       other .....      Sample Ret.

**Construction**

butt joint       mitred       pitched       other .....

**Grip plate**       Fabric = ormolou       brass       tin plated pewter       gilt tin   
 iron       silvered tin       enamelled       other .....      Sample Ret.

**Grip**       Fabric = ormolou       brass       iron  <sup>x1</sup>      Sample Ret.   
*too come to id.*

**Design**      swag of rose       horseshoe       cherub's head       plain   
 other .....

**Grip bolts**       **Corner bolts**       Type =      gilt brass       brass       iron   
 other .....      Sample Ret.

**Lid motifs**       other .....

**Escutcheons**       other .....

**Upholstery nails**       brass       gilt brass       silvered brass       iron       enamelled   
 other .....

**Fixings**       panel nails       screws       hinges       lace       Sample Ret.

**Timber type** .....      Sample Ret.

**Interpretation / Comments**

.....  
 .....

SITE	COFFIN RECORD SHEET	CONTEXT NO.
02200	Additional sheets:	816
Trench:	Grave fills	Treatment: BC
Site sub-div: SC	Grave cut:	Finds
Plan no: 6	Skeleton: 816	None
Section no:	Matrix location: 814 816	Breastplate Grip
Co-ordinates:	Preservation: GOOD	Hinge Bracket
Levels	Neg No:	Fixing nails Shroud pins
Slide No.		Fabric Other finds
<b>Description</b> E-W BABY SGEN IN MACHING BUCKET		
<b>Discussion</b>		
<b>Shape, dimensions and distinguishing characteristics</b>  LID  HEAD  BASE		
Recorder: Jhr	Date: 26/10/00	Initials:

SITE		COFFIN RECORD SHEET		CONTEXT NO.	
0LR00				817	
Trench:		Additional sheets: NES x1		Treatment:	
Site sub-div: SC		Grave fills		BC	
Plan no: 6		Grave cut:		Finds	
Section no:		Skeleton: 817		None	
Co-ordinates:		Matrix location: 817 1 820		Breastplate (FRAGS)	
Levels		Preservation: GOOD		Grip	
Slide No.		Neg No:		Hinge	
Description		6-W Adult		Bracket	
Discussion				Fixing nails	
Shape, dimensions and distinguishing characteristics				Shroud pins	
LID				Fabric	
HEAD				Other finds	
BASE					
Recorder: <i>[Signature]</i>		Date: 26/10/00		Initials:	

# Coffin Recording Sheet

Site Code

Context

**Outer Coffin**

Sample Ret.

OH200

817

Recording Date ..... 12/2/01 .....

Associated Numbers .....

Condition ..... 1 .....

Dep. Plate

Legible  NO

Inscription *ix frag of border w 1 x writing - illegible, except "feby"*

Fabric lead  ormolou  brass  tin plated pewter  gilt tin   
 iron  silvered tin  enamelled  other ..... Sample Ret.

**Shape of dep. plate**

square  rectangle  ? shield  tapered  lozenge   
 cartouche  oval  other .....

**Upholstery**

colour ..... shoddy  velvet  other ..... Sample Ret.

**Construction**

butt joint  mitred  pitched  other .....

**Grip plate**  Fabric = ormolou  brass  tin plated pewter  gilt tin   
 iron  silvered tin  enamelled  other ..... Sample Ret.

**Grip**  Fabric = ormolou  brass  iron  Sample Ret.

**Design** swag of rose  horseshoe  cherub's head  plain

other .....

**Grip bolts**  **Corner bolts**  Type = gilt brass  brass  iron

other ..... Sample Ret.

**Lid motifs**  other ..... Sample Ret.

**Escutcheons**  other ..... Sample Ret.

**Upholstery nails**  brass  gilt brass  silvered brass  iron  enamelled

other ..... Sample Ret.

**Fixings**  panel nails  screws  hinges  lace  Sample Ret.

**Timber type** ..... Sample Ret.

**Interpretation / Comments**

.....  
 .....



SITE 2LR00	COFFIN RECORD SHEET		CONTEXT NO. 818
Trench:	Additional sheets:	Treatment: BC	
Site sub-div: SC	Grave fills		
Plan no: 6	Grave cut:	Finds None	
Section no:	Skeleton: 818	Breastplate Grip	
Co-ordinates:	Matrix location: VAULT OUTSIDE DIG	Hinge Bracket	
Levels	Preservation: POOR	Fixing nails Shroud pins	
Slide No.	Neg No:	Fabric Other finds	
<p>Description: 6-C Adult S. limit of site half machined cut. Fragmentary.</p> <p>Discussion:</p>			
<p>Shape, dimensions and distinguishing characteristics</p> <p>LID</p> <p>HEAD</p> <p>BASE</p>			
Recorder: JH	Date: 27/10/00	Initials:	

# Coffin Recording Sheet

Site Code

Context

**Outer Coffin**

Sample Ret.

OH200

818

Recording Date ..... 16/2/01 .....

Associated Numbers .....

Condition .....

Dep. Plate

Legible

Inscription

Fabric lead  ormolou  brass  tin plated pewter  gilt tin   
 iron  silvered tin  enamelled  other ..... Sample Ret.

**Shape of dep. plate**

square  rectangle  shield  tapered  lozenge   
 cartouche  oval  other .....

**Upholstery**

colour ..... shoddy  velvet  other ..... Sample Ret.

**Construction**

butt joint  mitred  pitched  other .....

Grip plate  Fabric = ormolou  brass  tin plated pewter  gilt tin   
 iron  silvered tin  enamelled  other ..... Sample Ret.

Grip  Fabric = ormolou  brass  iron  x2 Sample Ret.

Design swag of rose  horseshoe  cherub's head  ①'s plain   
 other .....

Grip bolts  Corner bolts  Type = gilt brass  brass  iron   
 other ..... Sample Ret.

Lid motifs  other ..... Sample Ret.

Escutcheons  other ..... Sample Ret.

Upholstery nails  brass  gilt brass  silvered brass  iron  enamelled   
 other ..... Sample Ret.

Fixings  panel nails  screws  hinges  lace  Sample Ret.

Timber type ..... Sample Ret.

**Interpretation / Comments**

.....  
 .....

SITE		COFFIN RECORD SHEET		CONTEXT NO. 819	
Trench:		Additional sheets:		Treatment:	
Site sub-div: SC.		Grave fills		B.C.	
Plan no: 6		Grave cut:		Finds	
Section no:		Skeleton: 819		None	
Co-ordinates:		Matrix location:		Breastplate FRAGS	
Levels		Preservation: FAIR		Grip ✓	
Slide No.		Neg No:		Hinge	
Description				Bracket	
Discussion				Fixing nails	
				Shroud pins	
				Fabric	
				Other finds	
<p>6-W Adult in a beech coffin 1.65 x 0.65m with a wooden interior &amp; surround. Over which a limestone slab was placed 0.10m thick &amp; 1.65 x 0.65 in length &amp; width. No name plate but remnants of an Fe are beneath stone slab</p>					
Shape, dimensions and distinguishing characteristics					
LID					
HEAD					
BASE					
Recorder: [Signature]		Date: 27/10/02		Initials:	

**Outer Coffin**

Sample Ret.

Site Code

Context

Recording Date ..... 21/2/01 .....

Oh200

819

Associated Numbers .....

Condition .....

Dep. Plate

Legible

Inscription

Fabric lead       ormolou       brass       tin plated pewter       gilt tin   
 iron       silvered tin       enamelled       other .....      Sample Ret.

**Shape of dep. plate**

square       rectangle       shield       tapered       lozenge   
 cartouche       oval       other .....

**Upholstery**

colour .....      shoddy       velvet       other .....      Sample Ret.

**Construction**

butt joint       mitred       pitched       other .....

Grip plate  *Fabric = ormolou*       brass       tin plated pewter       gilt tin   
*Flags on rev of grip-wood*  
 iron       silvered tin       enamelled       other .....      Sample Ret.

Grip  *Fabric = ormolou*       brass       iron       Sample Ret.  *IX (4)*

Design      swag of rose       horseshoe       cherub's head       plain   
 other .....

Grip bolts       Corner bolts       Type =      gilt brass       brass       iron

other .....      Sample Ret.

Lid motifs       other .....      Sample Ret.

Escutcheons       other .....      Sample Ret.

Upholstery nails       brass       gilt brass       silvered brass       iron       enamelled

other .....      Sample Ret.

Fixings            panel nails       screws       hinges       lace       Sample Ret.

Timber type .....      Sample Ret.

**Interpretation / Comments**

.....  
 .....

SITE		COFFIN RECORD SHEET		CONTEXT NO.	
02R00				820	
Trench:		Additional sheets:		Treatment:	
Site sub-div: SC		Grave fills		B.C.	
Plan no: 6		Grave cut:		Finds	
Section no:		Skeleton: 820		None	
Co-ordinates:		Matrix location: 817 820		Breastplate ✓ Grip ✓	
Levels		Preservation: 821 Poor		Hinge	
Slide No.		Neg No:		Bracket	
Description		6-6 Adult lower arm/hands & torso rotten away.		Fixing nails	
Discussion				Shroud pins	
Shape, dimensions and distinguishing characteristics				Fabric	
LID				Other finds	
HEAD					
BASE					
Recorder: JH		Date: 27/10/00		Initials:	

Site Code

Context

**Outer Coffin**

Sample Ret.

OLR00

820

Recording Date ..... 16/2/01 .....

Associated Numbers .....

Condition ..... 1 .....

Dep. Plate

Legible  ISH

Inscription "Mr? / ? horeen Chr? / Died 26<sup>th</sup> Nov<sup>r</sup> / 1812

Fabric lead  <sup>⑥</sup> ormolou  brass  tin plated pewter  gilt tin   
iron  silvered tin  enamelled  other ..... Sample Ret.

**Shape of dep. plate**

square  rectangle  ? shield  tapered  lozenge   
cartouche  oval  other .....

**Upholstery**

colour ..... shoddy  velvet  other ..... Sample Ret.

**Construction**

butt joint  mitred  pitched  other .....

Grip plate  Fabric = ormolou  brass  tin plated pewter  gilt tin   
iron  <sup>tags on rev of grip</sup> silvered tin  <sup>③</sup> enamelled  other ..... Sample Ret.

Grip  Fabric = ormolou  brass  iron  x3 Sample Ret.

Design swag of rose  horseshoe  cherub's head  <sup>④</sup> plain   
other .....

Grip bolts  Corner bolts  Type = gilt brass  brass  iron   
other ..... Sample Ret.

Lid motifs  other ..... Sample Ret.

Escutcheons  other ..... Sample Ret.

Upholstery <sup>studs</sup> nails  brass  gilt brass  silvered brass  iron  enamelled   
other ..... <sup>2x 00000 = 10 studs.</sup> Sample Ret.

Fixings  panel nails  screws  hinges  lace  Sample Ret.

Timber type ..... Sample Ret.

**Interpretation / Comments**

.....  
.....

SITE 02200	COFFIN RECORD SHEET	CONTEXT NO. 821
Trench:	Additional sheets:	Treatment:
Site sub-div: 3C	Grave fills	B.C.
Plan no: 6	Grave cut:	Finds None
Section no:	Skeleton: 821	Breastplate ✓ Grip ✓
Co-ordinates:	Matrix location: 820 821	Hinge Bracket
Levels	Preservation: FAIR	Fixing nails Shroud pins
Slide No.	Neg No:	Fabric Other finds
<p>Description 6-W Adult in lead coffin too warped to measure.</p> <p>Discussion</p>		
<p>Shape, dimensions and distinguishing characteristics</p> <p>LID</p> <p>HEAD</p> <p>BASE</p>		
Recorder: [Signature]	Date: 27/10/00	Initials:

**Outer Coffin**

Sample Ret.

Site Code

Context

Recording Date ..... 21/2/01 .....

OK200

821

Associated Numbers .....

Condition ..... 1 .....

Dep. Plate

Legible  154 - in 5x frogs

Inscription ? / Sarah? Cheswell? / Died 11<sup>th</sup> July? / 1818 / Aged 72 Yrs (6) w/ no borders.

Fabric lead  ormolou  brass  tin plated pewter  gilt tin   
iron  silvered tin  enamelled  other ..... Sample Ret.

**Shape of dep. plate**

square  rectangle  shield  tapered  lozenge   
cartouche  oval  other .....

**Upholstery**

colour ..... shoddy  velvet  other ..... Sample Ret.

**Construction**

butt joint  mitred  pitched  other .....

Grip plate  Fabric = ormolou  brass  tin plated pewter  gilt tin   
iron  silvered tin  enamelled  other ..... Sample Ret.

Grip  Fabric = ormolou  brass  iron  Sample Ret.

Design swag of rose  horseshoe  cherub's head  plain   
other .....

Grip bolts  Corner bolts  Type = gilt brass  brass  iron   
other ..... Sample Ret.

Lid motifs  other ..... Sample Ret.

Escutcheons  other ..... Sample Ret.

Upholstery nails  brass  gilt brass  silvered brass  iron  enamelled   
other ..... Sample Ret.

Fixings  panel nails  screws  hinges  lace  Sample Ret.

Timber type ..... Sample Ret.

**Interpretation / Comments**

.....  
.....



SITE		COFFIN RECORD SHEET		CONTEXT NO.	
02100				822	
Trench:		Additional sheets:		Treatment:	
Site sub-div: 3C		Grave fills		B.C.	
Plan no: 6		Grave cut:		Finds	
Section no:		Skeleton: 822		None	
Co-ordinates:		Matrix location: 821 812		Breastplate	
Levels		Preservation: 823 Poor		Grip	
Slide No.		Neg No:		Hinge	
				Bracket	
				Fixing nails	
				Shroud pins	
				Fabric	
				Other finds	
Description					
E-W Adult in LEAD coffin v. deep so machined out					
Discussion					
Shape, dimensions and distinguishing characteristics					
LID					
HEAD					
BASE					
Recorder: JW		Date: 27/10/00		Initials:	

SITE	COFFIN RECORD SHEET	CONTEXT NO.
021200		823
Trench:	Additional sheets:	Treatment:
Site sub-div: SC	Grave fills	BC
Plan no: 6	Grave cut:	Finds
Section no:	Skeleton: 823	None
Co-ordinates:	Matrix location: 822 823 824	Breastplate
Levels	Preservation: Poor	Grip
Slide No.	Neg No:	Hinge
		Bracket
		Fixing nails
		Shroud pins
		Fabric
		Other finds
Description		
6-w Adult in LEAD COFFIN MIXING WITH 824 HEAD & UPPER MISSING 824?		
Discussion		
MACHINED OUT		
2 skeletons, 1 remembered to 1319.		
Shape, dimensions and distinguishing characteristics		
LID		
HEAD		
BASE		
Recorder: JW	Date: 27/10/00	Initials:

SITE 06200	COFFIN RECORD SHEET	CONTEXT NO. 824
Trench:	Additional sheets:	Treatment: BC
Site sub-div: SC	Grave fills	
Plan no: 6	Grave cut:	Finds None
Section no:	Skeleton: 824	Breastplate Grip
Co-ordinates:	Matrix location: 823 824	Hinge Bracket
Levels	Preservation: GOOD	Fixing nails Shroud pins
Slide No.	Neg No:	Fabric Other finds
<p>Description: 6-W Adult MIXED WITH 823</p> <p>Discussion: MACHINED OUT (POSSIBLY UPPER HALF BELONGS TO 823)</p>		
<p>Shape, dimensions and distinguishing characteristics</p> <p>LID</p> <p>HEAD</p> <p>BASE</p>		
Recorder: <i>JLW</i>	Date: 26/10/00	Initials:

SITE <i>OUR 00</i>		COFFIN RECORD SHEET	CONTEXT NO. <i>825</i>
Trench:	Additional sheets:	Treatment:	
Site sub-div: <i>SC</i>	Grave fills	<i>B.C.</i>	
Plan no: <i>6</i>	Grave cut:	Finds None <input checked="" type="checkbox"/>	
Section no:	Skeleton:	Breastplate Grip	
Co-ordinates:	Matrix location: <i>(825)</i> <i>(826)</i>	Hinge Bracket	
Levels	Preservation: <i>100%</i>	Fixing nails Shroud pins	
Slide No.	Neg No:	Fabric Other finds	
Description <i>E &amp; W ADULT BURIAL.</i>			
Discussion			
Shape, dimensions and distinguishing characteristics			
LID			
HEAD			
BASE			
Recorder: <i>ASM</i>	Date: <i>29/10/00</i>	Initials:	

SITE	COFFIN RECORD SHEET	CONTEXT NO.
02R00		826
Trench:	Additional sheets:	Treatment:
Site sub-div: SC	Grave fills	B.C.
Plan no: 6	Grave cut:	Finds
Section no:	Skeleton:	None
Co-ordinates:	Matrix location: 825 826	Breastplate
Levels	Preservation: <del>None</del> Poor.	Grip
Slide No.	Neg No:	Hinge
		Bracket
		Fixing nails
		Shroud pins
		Fabric
		Other finds
Description E-DW ADULT BURIAL.		
Discussion		
Shape, dimensions and distinguishing characteristics		
LID		
HEAD		
BASE		
Recorder: <i>VM</i>	Date: 27.10.00	Initials:

db

SITE <u>OLKOO</u>	COFFIN RECORD SHEET	CONTEXT NO. <u>827</u>
Trench:	Additional sheets: <u>YES X 1.</u>	Treatment:
Site sub-div: <u>SC</u>	Grave fills	<u>Teeth collected</u>
Plan no: <u>3</u>	Grave cut:	Finds None
Section no:	Skeleton: <u>Good</u>	Breastplate Grip
Co-ordinates:	Matrix location: <u>827</u>	Hinge Bracket
Levels	Preservation:	Fixing nails Shroud pins
Slide No.	Neg No:	Fabric Other finds

Description E & W ADULT BURIAL, WOODEN COFFIN WITH BREASTPLATE (V. POOR CONDITION, ∴ NO NAME) STUCK ON TOP OF THE COFFIN

Discussion Extra bones: Left Maxillary M7 & M8  
Right Pm1 } Mandible  
" I2 }

Shape, dimensions and distinguishing characteristics

LID

HEAD

BASE

Recorder: <u>BM</u>	Date: <u>01/11/60</u>	Initials:
---------------------	-----------------------	-----------

**Outer Coffin**

Sample Ret.

Site Code

Context

OLR00

827

Recording Date ..... 18/12/00 .....

Associated Numbers .....

Condition ..... 1 .....

Dep. Plate

Legible  NO

Inscription  
Same as 1184

Fabric lead  ormolou  brass  tin plated pewter  gilt tin   
 iron  silvered tin  enamelled  other ..... Sample Ret.   
*black polished.*

**Shape of dep. plate**

square  rectangle  shield  tapered  lozenge   
 cartouche  oval  other .....

**Upholstery**

colour ..... shoddy  velvet  other ..... Sample Ret.

**Construction**

butt joint  mitred  pitched  other .....

**Grip plate**  Fabric = ormolou  brass  tin plated pewter  gilt tin   
 iron  silvered tin  enamelled  other ..... Sample Ret.

**Grip**  Fabric = ormolou  brass  iron  Sample Ret.

**Design** swag of rose  horseshoe  cherub's head  plain   
 other .....

**Grip bolts**  **Corner bolts**  **Type =** gilt brass  brass  iron   
 other ..... Sample Ret.

**Lid motifs**  other ..... Sample Ret.

**Escutcheons**  other ..... Sample Ret.

**Upholstery** <sup>studs</sup> nails  brass  gilt brass  silvered brass  iron  enamelled   
 other ..... 3x00 / 1x000 / 1x00000 / 1x00000 = 25 studs in total. Sample Ret.

**Fixings**  panel nails  screws  hinges  lace  Sample Ret.

**Timber type** ..... Sample Ret.

**Interpretation / Comments**

.....  
 .....

SITE <b>OLROO</b>		CONTEXT RECORD		Context No. <b>828</b>
Trench		Additional Sheets:		Type <b>STRUC</b>
Site sub-div <b>S.C.</b>	Context Type: Deposit / Cut / <b>Structure</b>	Check Lists:		
Structure No.	Overlain by: <b>church path/steps</b>	DEPOSIT:		
Plan No. <b>6.</b>	Abutted by:	1.compaction 2.colour 3.composition 4.inclusions 5.thickness 6.extent 7.comments 8.method & conditions		
Section No.	Cut by:	CUT:		
Co-Ordinates	Filled by:	1.shape in plan 2.base/sides/top profile 3.dimension and depth 4.sketch 5.truncation 6.fill nos 7.other comments		
Level	Same as:	MASONRY:		
Slide No.	Part of:	1.materials 2.size of bricks etc 3.finish of stones 4.coursing/bond 5.form 6.faces 7.bond 8.dimensions as found 9.other comments		
Neg No.	Consists of:			
Matrix location	Overlies:			
	Butts:			
	Cuts:			
	Fill of:			
	Relationships uncertain			
Description (See check lists):		STRATIGRAPHIC MATRIX		
<p><b>Probable vault adjacent to SE corner of church, consists of upright walls :- red bricks (0.23 x 105 x 0.06 m) bonded with lime rich offwhite mortar, dimension 1.75m out from church wall to</b></p> <p><b>seen for 4.5m (east end not clear). Has arched roof (N-S) of yellow brick (0.23 x 111 x 0.07 m) clearly of different const./phase to bonded with hard buff coloured mortar. Arch/walls 'broken out' in line with church door above to structure, backfilled with rubble etc - no burials present. (top of arch 0.5m below present ground surface)</b></p>				
Interpretation/Discussion:				
<p><b>Probable vault which was never used &amp; appears to have a later backfill/roof - pos to secure the ground for the church steps which were sited above it.</b></p> <p><b>(Height of walls c. 1m).</b></p>				
Finds (tick): None <input type="checkbox"/> Pot <input type="checkbox"/> Bone <input type="checkbox"/> Flint <input type="checkbox"/> Stone <input type="checkbox"/> Burnt stone <input type="checkbox"/> Glass <input type="checkbox"/> Metal <input type="checkbox"/> CBM <input type="checkbox"/> Wood <input type="checkbox"/> Leather <input type="checkbox"/>				
△ Small Finds			Recorder <b>DS</b>	
◇ Samples			Date <b>23/10</b>	
▢ Building Materials			Initials	



dp

SITE 02100	COFFIN RECORD SHEET	CONTEXT NO. 839
Trench:	Additional sheets:	Treatment: BODY BAZZED. NO DNA.
Site sub-div: Cimet BAN4	Grave fills	
Plan no: 7.	Grave cut:	Finds None
Section no:	Skeleton: - NOT AT ALL PRESENT - LE PARTIALLY ROTTEN.	Breastplate Grip x 2
Co-ordinates:	Matrix location: <del>1/2</del> <del>2/2</del>	Hinge Bracket
Levels	Preservation: BADLY CORRODED AROUND BASE/SIDES.	Fixing nails Shroud pins
Slide No.	Neg No:	Fabric Other finds

Description  
Pb Coffin.  
RINNET.

- SKELETON SHROUDED IN MESSIAN  
THOUGH NOT PARTICULARLY WELL  
PRESERVED.

Discussion  
TRACES OF OUTER COFFIN / GRIPS PRESENT.

Shape, dimensions and distinguishing characteristics

INSCRIPTION

ME C ? ? a  
J ? ? - ogg  
Died 3<sup>rd</sup> Aug  
1839  
Aged 22 1/5

~~STRONG~~ CUT MARKS ON COFFIN LID  
- ATTEMPTED GRAVE ROBBING?

DEPTH: 0.32

Recorder: An.	Date: 25.10.00.	Initials:
---------------	-----------------	-----------

db

SITE 02100	COFFIN RECORD SHEET	CONTEXT NO. 830.
Trench:	Additional sheets:	Treatment: BONES LIFTED CLEAR FOR DNA
Site sub-div: CRPT BAN 4	Grave fills:	
Plan no: 7	Grave cut:	Finds None ✓
Section no:	Skeleton: were preserved.	Breastplate Grip
Co-ordinates:	Matrix location: U/L 597	Hinge Bracket
Levels:	Preservation: badly corroded on sides/base.	Fixing nails Shroud pins
Slide No.:	Neg No.:	Fabric Other finds

Description: 16 Coffin - square REMAINS of OUTER COFFIN ON LID ONLY  
INFANT

Discussion:

Shape, dimensions and distinguishing characteristics

INSCRIPTION: -

Mifs Mary  
Ann Coleman

DEPTH: 0.19m

Recorder: [Signature] Date: 25.10.00 Initials:

db

SITE	COFFIN RECORD SHEET	CONTEXT NO.
OLROO		8002 831
Trench:	Additional sheets: 465x1	Treatment:
Site sub-div: CRUFT SAN 4	Grave fills	
Plan no: 7.	Grave cut:	Finds None <input checked="" type="checkbox"/>
Section no:	Skeleton:	Breastplate Grip <input checked="" type="checkbox"/> shield x 3 w/ fe. grip plate frag. und
Co-ordinates:	Matrix location: V/L 518.	Hinge
Levels	Preservation:	Bracket
Slide No:	Neg No: film	Fixing nails
		Shroud pins
		Fabric
		Other finds

**Description** Pb Coffin INSCRIPTION ON PLATE :-  
 (ON COFFIN) MRS Mary  
 - QUITE SQUASHED. Ann Monk  
 Died 16th Jan<sup>y</sup>  
 1847  
 In her 57<sup>th</sup> Year

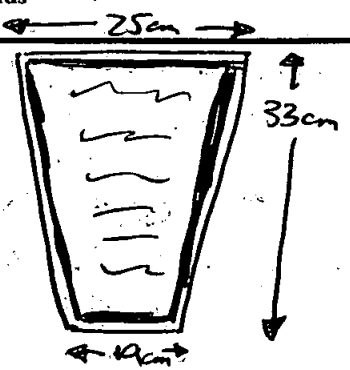

**Shape, dimensions and distinguishing characteristics**  
 Coffin with dark blue bands :-

LID  
HEAD  
BASE

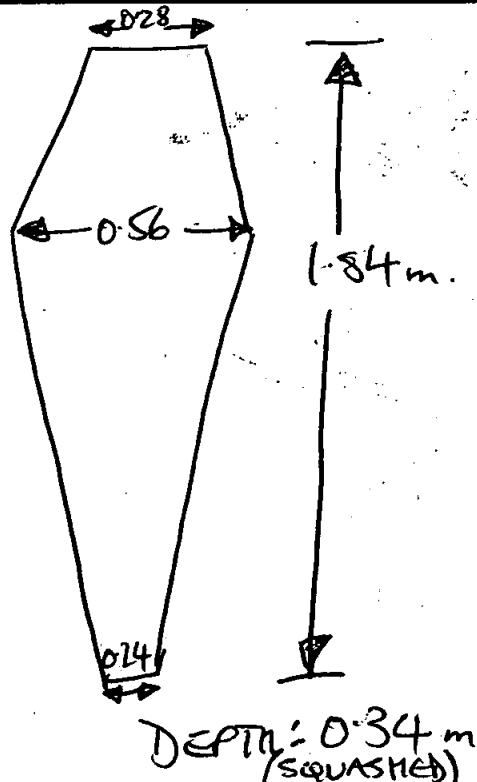
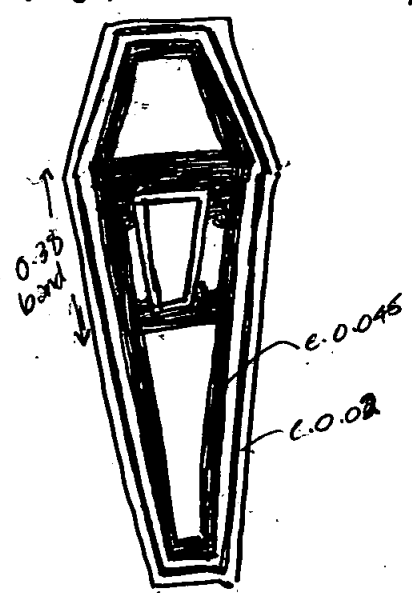

Recorder: AM	Date: 25-10-00	Initials:
--------------	----------------	-----------

# Coffin Recording Sheet

**Outer Coffin**

Sample Ret.

Site Code

Context

Recording Date ..... 25/10

01R00

831

Associated Numbers .....

Condition .....

Dep. Plate

Legible

Inscription

Fabric lead  ormolou  brass  tin plated pewter  gilt tin   
iron  silvered tin  enamelled  other ..... Sample Ret.

**Shape of dep. plate**

square  rectangle  shield  tapered  lozenge   
cartouche  oval  other .....

**Upholstery**

colour ..... shoddy  velvet  other ..... Sample Ret.

**Construction**

butt joint  mitred  pitched  other .....

**Grip plate**  Fabric = ormolou  brass  tin plated pewter  gilt tin   
iron  silvered tin  enamelled  other ..... Sample Ret.   
*Flags on rev. of grip.*

**Grip**  Fabric = ormolou  brass  iron  x2 Sample Ret.

**Design** swag of rose  horseshoe  cherub's head  plain   
other ..... *conc.*

**Grip bolts**  **Corner bolts**  **Type =** gilt brass  brass  iron   
other ..... Sample Ret.

**Lid motifs**  other ..... Sample Ret.

**Escutcheons**  other ..... Sample Ret.

**Upholstery nails**  brass  gilt brass  silvered brass  iron  enamelled   
other ..... Sample Ret.

**Fixings**  panel nails  screws  hinges  lace  Sample Ret.

**Timber type** ..... Sample Ret.

**Interpretation / Comments**

.....  
.....

db

SITE <u>Oldloo</u>		COFFIN RECORD SHEET	CONTEXT NO. <u>832</u>
Trench:	Additional sheets:	Treatment:	
Site sub-div: <u>ANTH/6M4</u>	Grave fills:	<u>BONES COUROS.</u>	
Plan no: <u>7</u>	Grave cut:	Finds None <input checked="" type="checkbox"/>	
Section no:	Skeleton: <u>poor - crushed by coffin</u>	Breastplate Grip	
Co-ordinates:	Matrix location: <u>(832)</u>	Hinge Bracket	
Levels:	Preservation: <u>poor</u>	Fixing nails Shroud pins	
Slide No.:	Neg No.:	Fabric Other finds	

**Description** W-DE ADULT BURIAL. 10 LINED COFFIN SOLDERS TOP & BASE. REMAINS OF SEARCHED I.D. PLATE ON BREAST OF COFFIN - HOWEVER TOO BADLY DAMAGED TO READ. COFFIN (Pb.) APPEARS TO HAVE BLUE/BLACK SANDING (SEE BELOW) - HOWEVER, COFFIN Pb OF POOR QUALITY (I.E. V. THIN, SOLDERING POOR), BUT INNER LAMEN UNING VERY GOOD QUALITY (0.025m THICK).

**Discussion**

Shape, dimensions and distinguishing characteristics

LID

No NAME

HEAD

BASE

0.0045 wide

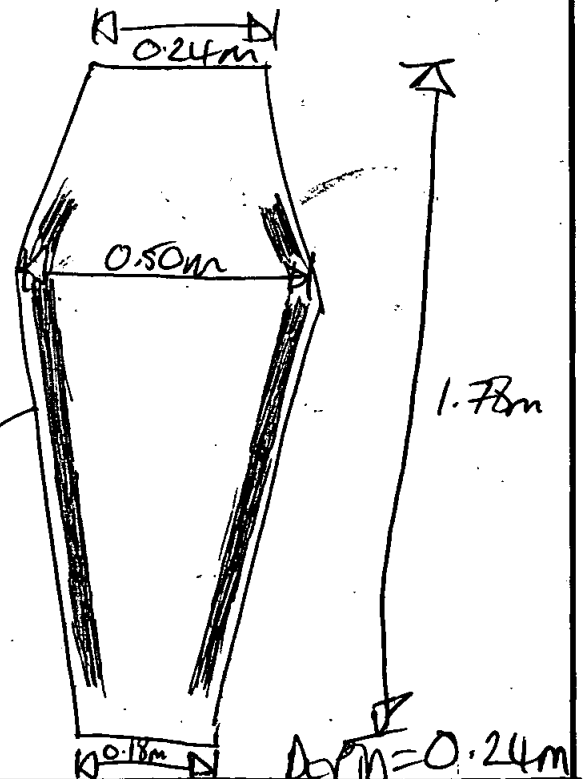

Recorder: DBM

Date: 26/10/00

Initials:

dlp

SITE		COFFIN RECORD SHEET		CONTEXT NO. 833	
Trench:	Additional sheets: YES x2	Treatment: <del>★</del> Neufolius			
Site sub-div: <u>cont, B&amp;M 4</u>	Grave fills				
Plan no: <u>7</u>	Grave cut:	Finds None			
Section no:	Skeleton:	Breastplate ✓ Grip ✓			
Co-ordinates:	Matrix location: <u>(833)</u>	Hinge Bracket			
Levels	Preservation: <u>POOR</u>	Fixing nails Shroud pins			
Slide No.	Neg No:	Fabric Other finds			

**Description** E-W INFANT BURIAL. Pb LINED COFFIN SOLDERED TOP & BASE. BREASTPLATE PRESENT, ALSO. Pb COFFIN I.O. PLATE ~~SCHEMATIC~~ IS ENGRAVED FRONT OF COFFIN. ~~★~~ OUTSIDE WOOD TRACES PRESENT.

**Discussion**

**Shape, dimensions and distinguishing characteristics**

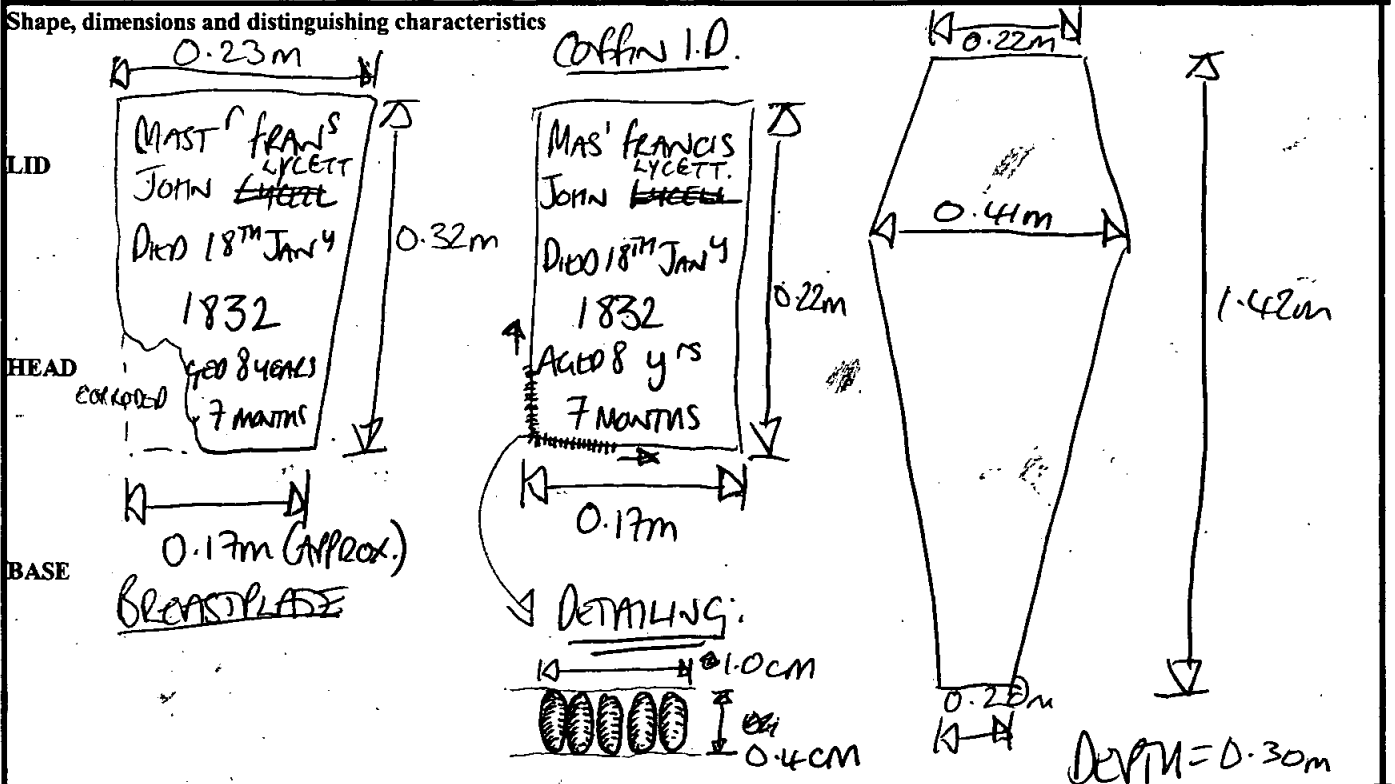

Recorder: <u>BBM</u>	Date: <u>27/10/00</u>	Initials:
----------------------	-----------------------	-----------

Site Code

Context

*Ok100*

*833*

**Outer Coffin**

Sample Ret.

Recording Date *27/10*

Associated Numbers .....

Condition .....

Dep. Plate

Legible

Inscription *"Mort<sup>r</sup> Fran<sup>s</sup> / John Lycett / Died 18<sup>th</sup> Jun<sup>y</sup> / 1832 / Aged 8 Years / & 7 Mon<sup>s</sup>"*

Fabric lead  ormolou  brass  tin plated pewter  gilt tin   
 iron  silvered tin  enamelled  other ..... Sample Ret.

**Shape of dep. plate**

square  rectangle  shield   
 cartouche  oval  other .....

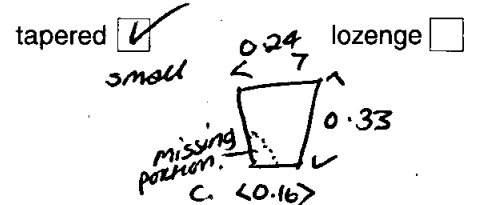

Upholstery   
 colour ..... shoddy  velvet  other ..... Sample Ret.

Construction butt joint  mitred  pitched  other .....

Grip plate  Fabric = ormolou  brass  tin plated pewter  gilt tin   
 iron  silvered tin  enamelled  other ..... Sample Ret.

Grip  Fabric = ormolou  brass  iron  *X1* Sample Ret.

Design swag of rose  horseshoe  cherub's head  plain   
 other ..... *smellish ① ← → = 0.105 ↓ = 0.055*

Grip bolts  Corner bolts  Type = gilt brass  brass  iron   
 other ..... Sample Ret.

Lid motifs  other ..... Sample Ret.

Escutcheons  other ..... Sample Ret.

Upholstery nails  brass  gilt brass  silvered brass  iron  enamelled   
 other ..... Sample Ret.

Fixings  panel nails  screws  hinges  lace  Sample Ret.

Timber type ..... Sample Ret.

**Interpretation / Comments**

.....  
 .....

db

SITE OLR00	COFFIN RECORD SHEET	CONTEXT NO.: 834
Trench:	Additional sheets:	Treatment: NO NAME BODY BAGGED.
Site sub-div: CAVITY BAY 4	Grave fills	
Plan no: 7.	Grave cut:	Finds None ✓
Section no:	Skeleton:	Breastplate Grip
Co-ordinates:	Matrix location: 834	Hinge Bracket
Levels	Preservation: V. POOR - OUTER COFFIN TRACKS ONLY	Fixing nails Shroud pins
Slide No.	Neg No:	Fabric Other finds

Description E-W Pb Coffin - NO NAME  
INFANT

Discussion - possibly associated with loose foot plate -  
however name corroded away - 'Aged 2' (yrs) only.

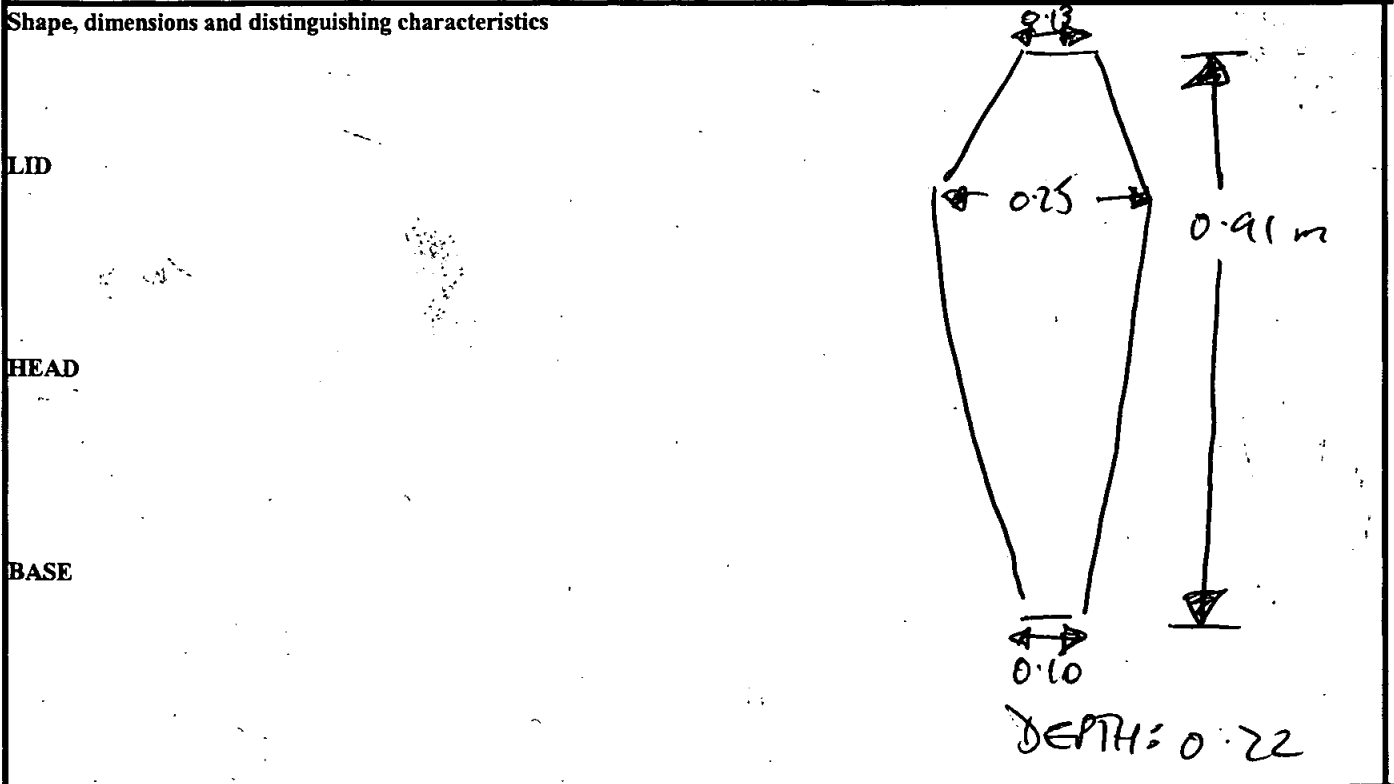

Recorder: <i>BM</i>	Date: 27.10.00.	Initials:
---------------------	-----------------	-----------



2/10

SITE OLKROO	COFFIN RECORD SHEET	CONTEXT NO. 835
Trench:	Additional sheets:	Treatment:
Site sub-div: OLYPT, 6M4	Grave fills	- PNECKOLIS
Plan no: 7	Grave cut:	Finds None ✓
Section no:	Skeleton:	Breastplate Grip
Co-ordinates:	Matrix location: 835	Hinge Bracket
Levels	Preservation: EXCELLENT.	Fixing nails Shroud pins
Slide No.:	Neg No:	Fabric Other finds

Description E-W ADULT BURIAL. 16 LINED COFFIN, SOUNDWOOD EXTREMELY WELL TOP & BASE. OTHER WOOD REMS PRESENT. ENGRAVED COFFIN I.D. ON BREAST OF COFFIN.

Discussion

Shape, dimensions and distinguishing characteristics

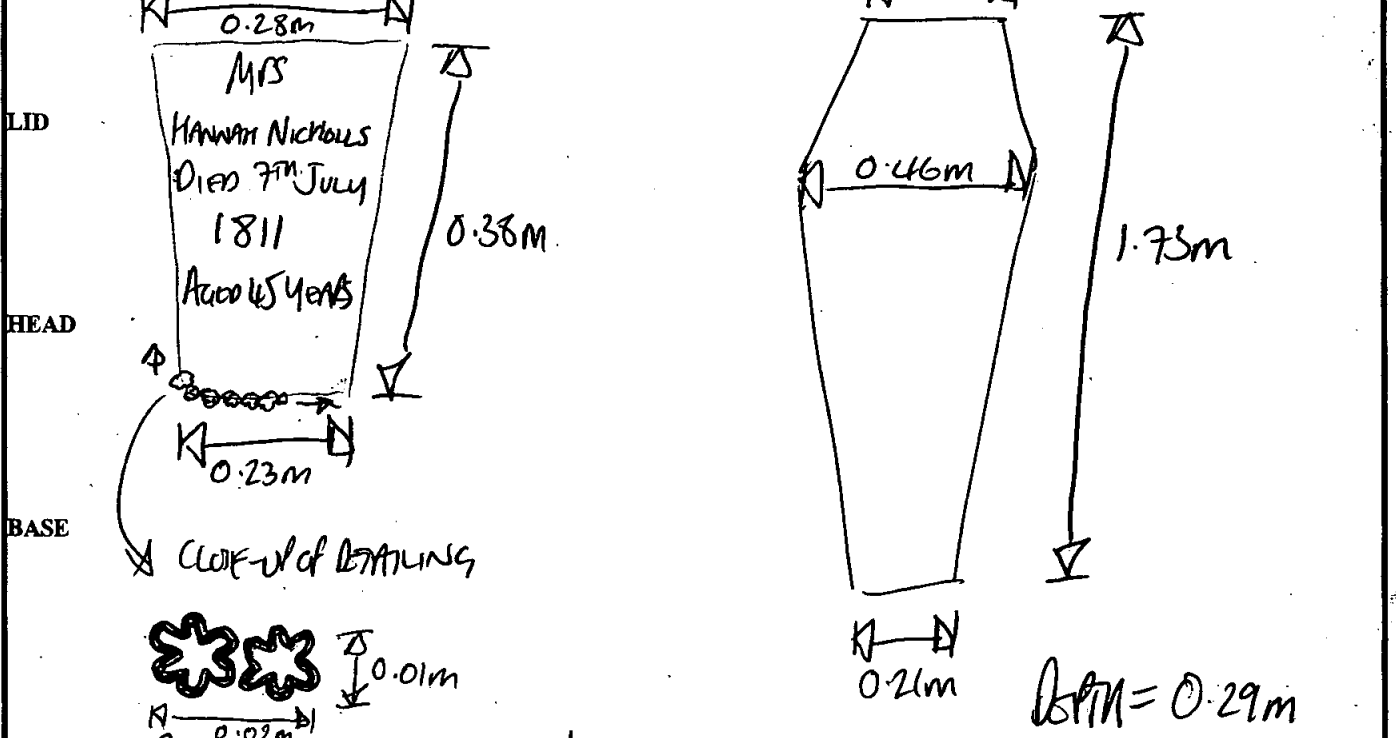

Recorder: [Signature]	Date: 27/10/00	Initials:
-----------------------	----------------	-----------

AP

SITE OLROO		COFFIN RECORD SHEET	CONTEXT NO. 836
Trench:	Additional sheets:	Treatment: - NO DNA	
Site sub-div: GRAPT, 6M4	Grave fills	BONE COLLECTED	
Plan no: 7	Grave cut:	Finds None	
Section no:	Skeleton:	Breastplate Grip	
Co-ordinates:	Matrix location: 836	Hinge Bracket	
Levels	Preservation: V. Poor	Fixing nails Shroud pins	
Slide No.	Neg No:	Fabric Other finds	

**Description** E-W ADULT BURIAL. Pb lined coffin selected top of base. OPENED BY HANDS FROM HEAD TO FOOT, PROBABLY BY AN AXE. NO NAME. ALSO SIDES ARE KICKED IN - SO MISTAKEN. SOME

**Discussion** BRAIN PRESENT WITHIN COFFIN.

Shape, dimensions and distinguishing characteristics

LID

No NAME

HEAD

BASE

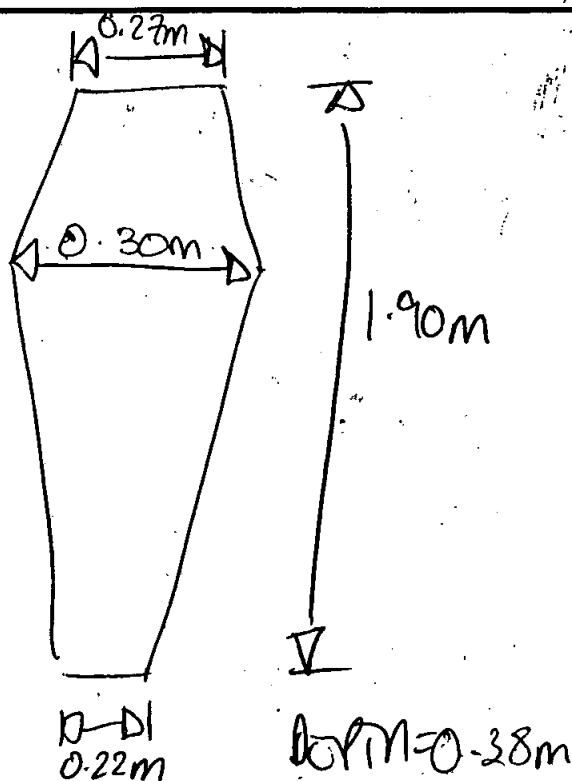

Recorder: <i>DM</i>	Date: 27.10.00	Initials:
---------------------	----------------	-----------

db

SITE	COFFIN RECORD SHEET	CONTEXT NO.
OLR 00		837
Trench:	Additional sheets:	Treatment:
Site sub-div: OLYPT, BM 4	Grave fills	BONE COLLECTED / DNA + TOOTH
Plan no: 7	Grave cut:	Findings
		None
Section no:	Skeleton:	Breastplate ✓
		Grip
Co-ordinates:	Matrix location: (837)	Hinge
		Bracket
Levels	Preservation: AVERAGE	Fixing nails
		Shroud pins
Slide No.	Neg No:	Fabric
		Other finds

**Description** E-W ADULT BURIAL. Pb LINED COFFIN SOLDERED TOP & BASE. BREASTPLATE, HEADPLATE BOTH PINNED TO AUPUR WOOD COFFIN. (AT SHOULDERS) COFFIN I.O. PLATE SOLDERED TO PRESENT OF COFFIN.

**Discussion** BLACK BORDER NOTED AROUND BASE OF COFFIN AFTER FLIPPING OVER TO OPEN.  
BRAN INFILL

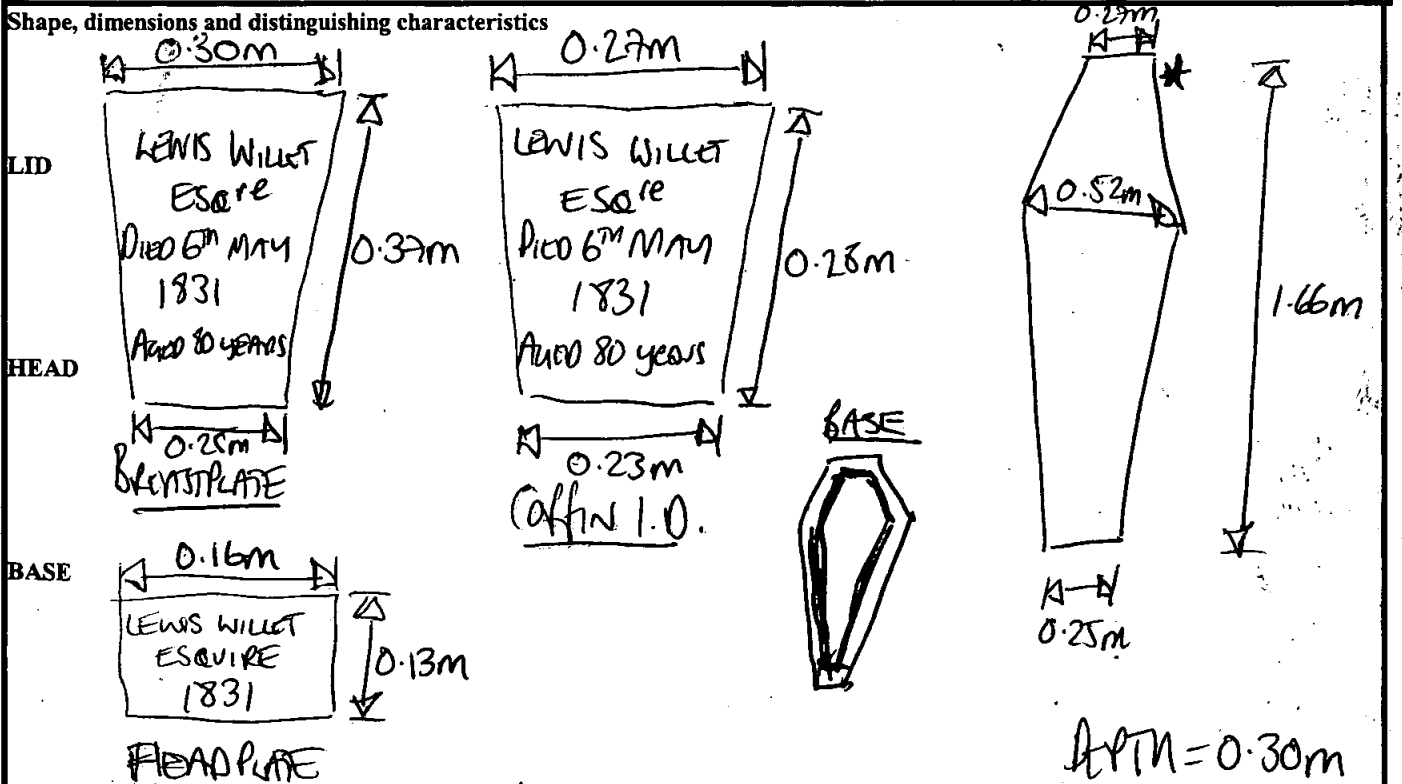

Recorder: *DM* Date: 27/10/00 Initials:

# Coffin Recording Sheet

Site Code

Context

02100

837

Outer Coffin

Sample Ret.

Recording Date ..... 27/10 .....

Associated Numbers .....

Condition .....

Dep. Plate

Legible

Inscription *a Lewis ~~Willet~~ Willet / 3 Eog<sup>r</sup> / Died 6<sup>th</sup> May / 1831 / Aged 80 Years<sup>m</sup>*

Fabric lead

ormolou

brass

tin plated pewter

gilt tin

iron

silvered tin

enamelled

other .....

Sample Ret.

Shape of dep. plate

square

rectangle

shield

tapered

lozenge

cartouche

oval

other .....

*(21) w/ 534 outer border.*

Upholstery

colour .....

shoddy

velvet

other .....

Sample Ret.

Construction

butt joint

mitred

pitched

other .....

Grip plate

Fabric = ormolou

brass

tin plated pewter

gilt tin

iron

silvered tin

enamelled

other .....

Sample Ret.

Grip

Fabric = ormolou

brass

iron

Sample Ret.

Design

swag of rose

horseshoe

cherub's head

plain

other .....

Grip bolts

Corner bolts

Type = gilt brass

brass

iron

other ..... Sample Ret.

Lid motifs

other ..... Sample Ret.

Escutcheons

other ..... Sample Ret.

Upholstery nails

brass

gilt brass

silvered brass

iron

enamelled

other ..... Sample Ret.

Fixings

panel nails

screws

hinges

lace

Sample Ret.

Timber type

Sample Ret.

Interpretation / Comments

.....  
.....

db

SITE OLR 00	COFFIN RECORD SHEET	CONTEXT NO. 838
Trench:	Additional sheets:	Treatment: BONES COLLECTED
Site sub-div: GRUPT, AM4	Grave fills	
Plan no: 7	Grave cut:	Finds None +
Section no:	Skeleton:	Breastplate Grip
Co-ordinates:	Matrix location: (838)	Hinge Bracket
Levels	Preservation: poor	Fixing nails Shroud pins
Slide No.	Neg No:	Fabric Other finds

Description W & E ADULT BURIAL. Pb LINED COFFIN SOLDERED TOP & BASE. NO NAME-PLATE OR I.O. COFFIN HAS BEEN CUT OPEN AT HEAD, POS. TO REMOVE SKULL

Discussion

Shape, dimensions and distinguishing characteristics

LID

NO NAME

HEAD

BASE

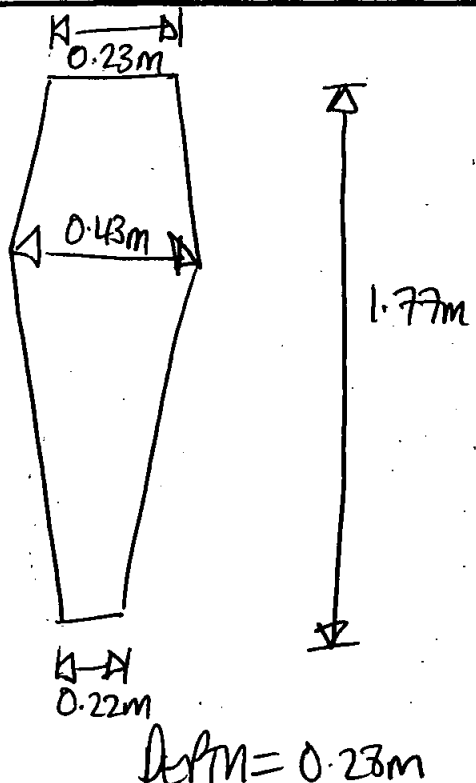

Recorder: BM	Date: 27/10/00	Initials:
--------------	----------------	-----------

add

SITE		COFFIN RECORD SHEET		CONTEXT NO. 839	
Trench:	Additional sheets: YES x 1	Treatment: <u>SOULS / DNA</u>			
Site sub-div: <u>ALYPT, 6AM14</u>	Grave fills				
Plan no: <u>7</u>	Grave cut:	Finds None			
Section no:	Skeleton:	Breastplate <input checked="" type="checkbox"/> Grip			
Co-ordinates:	Matrix location: <u>(839)</u>	Hinge Bracket			
Levels	Preservation: <u>POOR</u>	Fixing nails Shroud pins			
Slide No.	Neg No:	Fabric Other finds			

**Description** W-E ADULT BURIAL. PD LINDO COFFIN SOLDERED TOP & BASE. OUTER WOOD TRACES PRESENT. BREASTPLATE PRESENT, PINNED TO OUTER WOOD. SOLDERED I.D. PLATE ON BREAST OF COFFIN. COFFIN AT HEAD END HAS BEEN FORCED OPEN. SAW FORBIDDEN

**Discussion** HEAD END HAS BEEN FORCED OPEN. SAW FORBIDDEN

Shape, dimensions and distinguishing characteristics

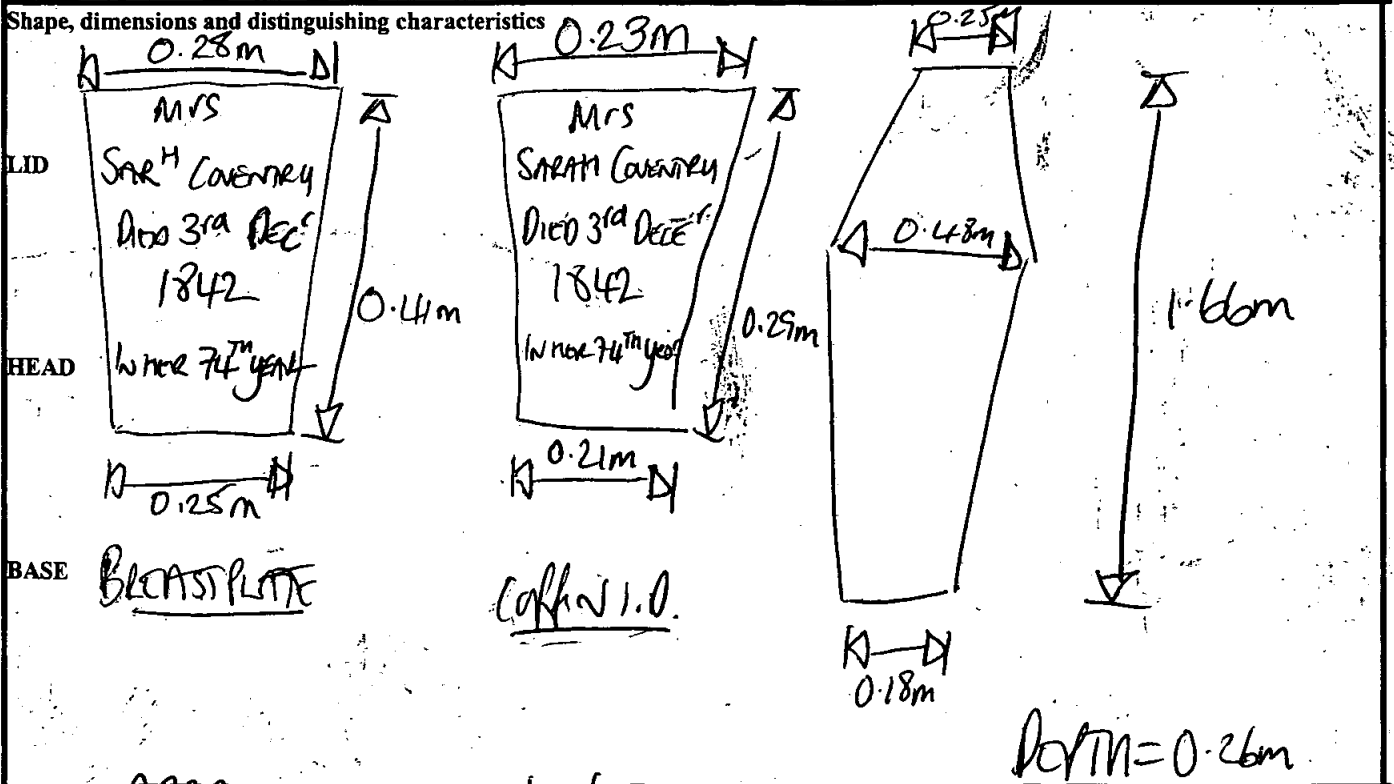

Recorder: <u>DBM</u>	Date: <u>27/10/00</u>	Initials:
----------------------	-----------------------	-----------

# Coffin Recording Sheet

Site Code

Context

**Outer Coffin**

Sample Ret.

OX200

839

Recording Date ..... 27/10, .....

Associated Numbers .....

Condition .....

Dep. Plate

Legible

Inscription "Mrs/Sae<sup>n</sup> Coventry/Died 3<sup>rd</sup> Dec<sup>r</sup>/1842/In her 74<sup>th</sup> Year"

Fabric lead  ormolou  brass  tin plated pewter  gilt tin   
 iron  silvered tin  enamelled  other ..... Sample Ret.

**Shape of dep. plate**

square  rectangle  shield  tapered  lozenge   
 cartouche  oval  other ..... *black polished*

**Upholstery**

colour ..... shoddy  velvet  other ..... Sample Ret.

**Construction**

butt joint  mitred  pitched  other .....

Grip plate  Fabric = ormolou  brass  tin plated pewter  gilt tin   
 iron  silvered tin  enamelled  other ..... Sample Ret.

Grip  Fabric = ormolou  brass  iron  Sample Ret.

Design swag of rose  horseshoe  cherub's head  plain   
 other .....

Grip bolts  Corner bolts  Type = gilt brass  brass  iron   
 other ..... Sample Ret.

Lid motifs  other ..... Sample Ret.

Escutcheons  other ..... Sample Ret.

Upholstery nails  brass  gilt brass  silvered brass  iron  enamelled   
 other ..... Sample Ret.

Fixings  panel nails  screws  hinges  lace  Sample Ret.

Timber type ..... Sample Ret.

**Interpretation / Comments**

.....  
 .....

Ab

SITE OLK00	COFFIN RECORD SHEET	CONTEXT NO. 840
Trench:	Additional sheets: YES X1	Treatment:
Site sub-div: OULT, BM2 VAULT 26	Grave fills	Bone Covered
Plan no: 7	Grave cut:	Finds None ✓
Section no:	Skeleton:	Breastplate Grip ✓
Co-ordinates:	Matrix location 840 842	Hinge Bracket
Levels	Preservation: Poor	Fixing nails Shroud pins
Slide No.	Neg No:	Fabric Other finds

**Description** E-W ADULT BURIAL. NO LINED COFFIN, TRACES OF OUTER WOOD PRESENT. SEARCHED TOP & BASE - COFFIN FOLDED  
 NO NAME, WITHIN VAULT 26

**Discussion**

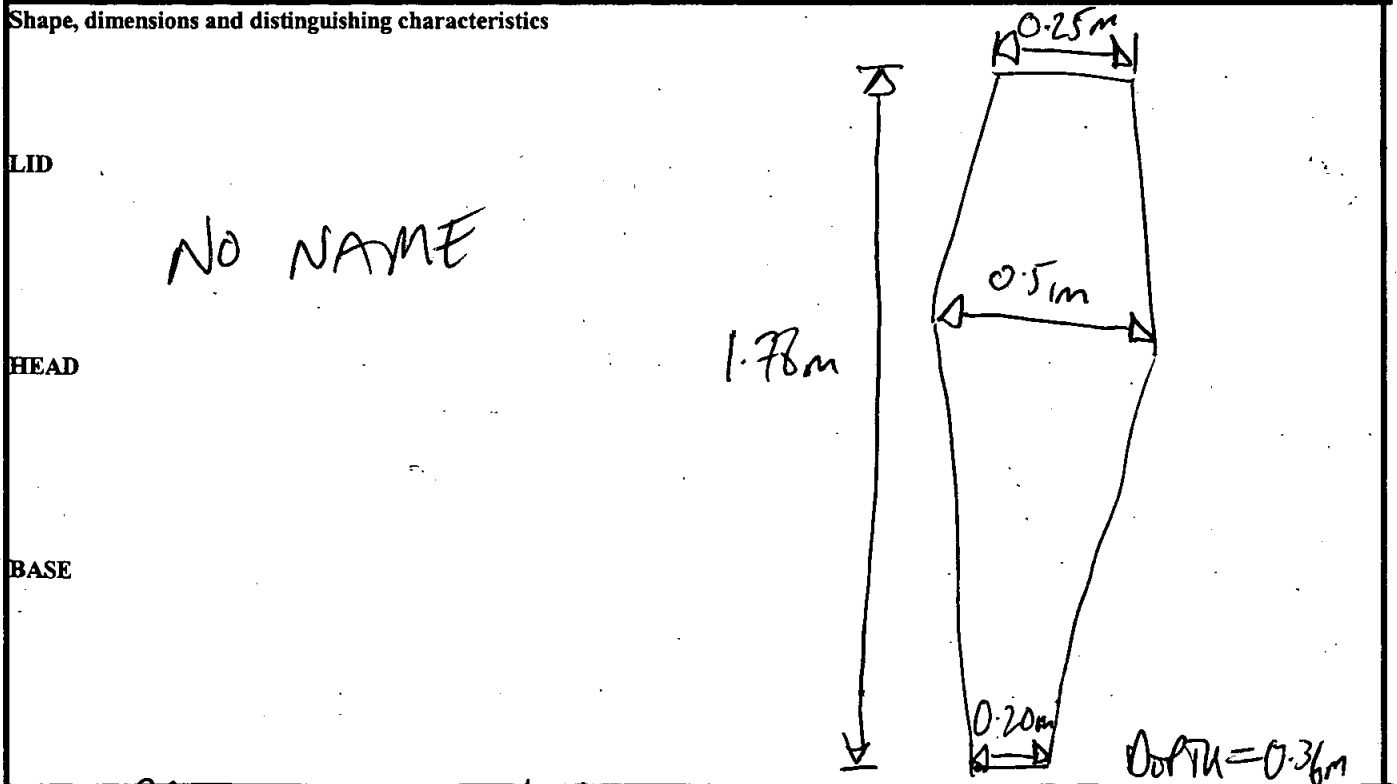

Recorder: JBM	Date: 31/10/00	Initials:
---------------	----------------	-----------



*db*

# Coffin Recording Sheet

**Outer Coffin**

Recording Date ..... 1/11/00 .....

Sample Ret.

Site Code

Context

Associated Numbers .....

Condition .....

Dep. Plate

Legible

Inscription

Fabric lead       ormolou       brass       tin plated pewter       gilt tin   
 iron       silvered tin       enamelled       other .....      Sample Ret.

**Shape of dep. plate**

square       rectangle       shield       tapered       lozenge   
 cartouche       oval       other .....

**Upholstery**

colour .....      shoddy       velvet       other .....      Sample Ret.

**Construction**      butt joint       mitred       pitched       other .....

**Grip plate**       Fabric = ormolou       brass       tin plated pewter       gilt tin   
 iron       silvered tin       enamelled       other .....      Sample Ret.

**Grip**       Fabric = ormolou       brass       iron  *X1*      Sample Ret.

**Design**      swag of rose       horseshoe       cherub's head       plain   
 other ..... *conc.*

**Grip bolts**       **Corner bolts**       Type =      gilt brass       brass       iron   
 other .....      Sample Ret.

**Lid motifs**       other .....      Sample Ret.

**Escutcheons**       other .....      Sample Ret.

**Upholstery nails**       brass       gilt brass       silvered brass       iron       enamelled   
 other .....      Sample Ret.

**Fixings**            panel nails       screws       hinges       lace       Sample Ret.

**Timber type** .....      Sample Ret.

**Interpretation / Comments**

.....  
 .....

DD

SITE OLKOO	COFFIN RECORD SHEET	CONTEXT NO. 841
Trench:	Additional sheets: YES x 1	Treatment: ONLY TEETH
Site sub-div: CRUPI, 6M42 VAULT 26	Grave fills	DNA <del>REMOVED</del> COLLECTED
Plan no: 7	Grave cut:	Finds None
Section no:	Skeleton: V. POOR - NEW - EXIST BENT EXCEPT FOR TEETH	Breastplate ✓ Grip ✓
Co-ordinates:	Matrix location: (841) 1 (843)	Hinge Bracket
Levels	Preservation: AVERAGE	Fixing nails Shroud pins
Slide No.	Neg No:	Fabric Other finds

**Description** E-W INFANT BURIAL. PL LINED COFFIN SOLIDWOOD TOP & BASE. BREASTPLATE & HEAD PLATE PINNED TO UPPER WOOD PLATES. SKELETON RECORDED INTO LINER - SHROUD PRESENT. WITHIN VAULT 126.

**Discussion**

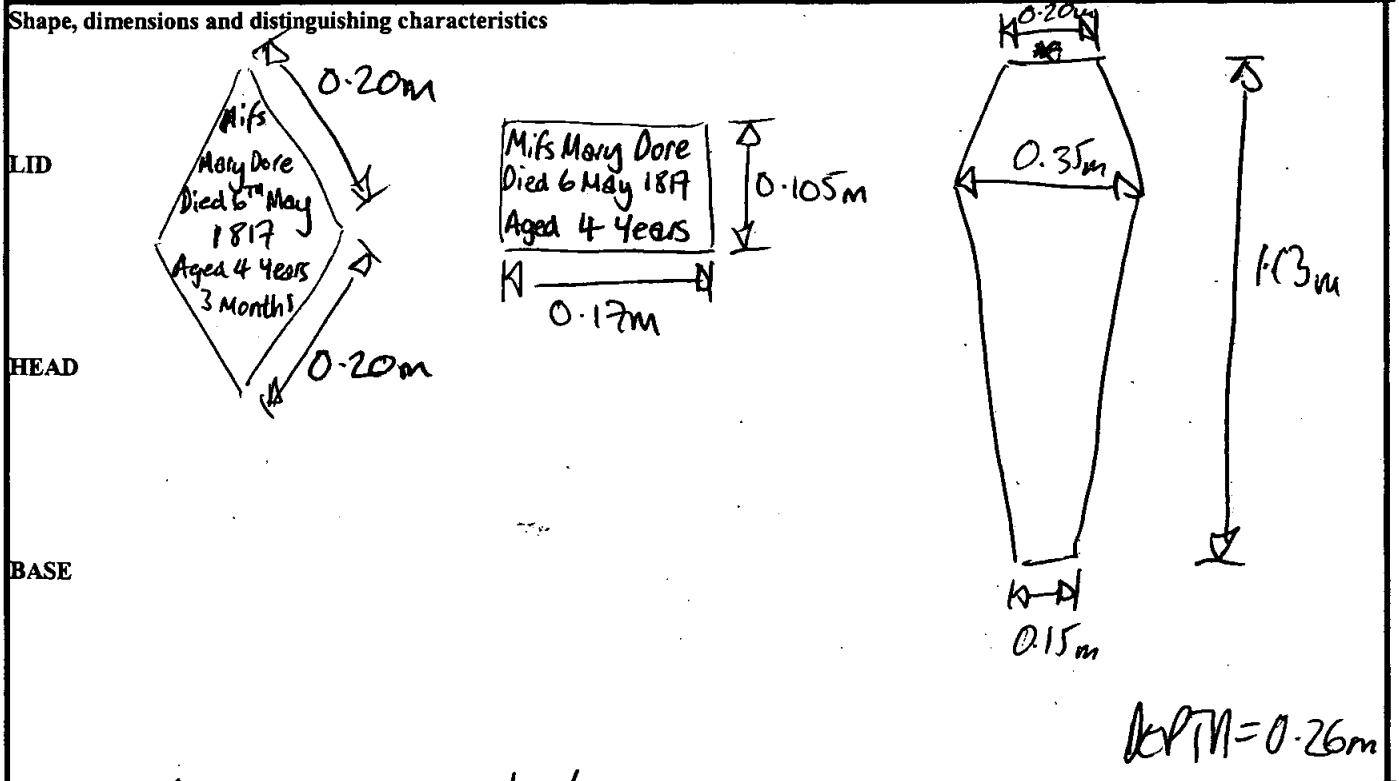

Recorder: PHM Date: 31/10/00 Initials:

# Coffin Recording Sheet

Site Code

Context

ONK00

841

Outer Coffin

Sample Ret.

Recording Date 1/11/00

Associated Numbers .....

Condition .....

Dep. Plate

Legible

Inscription *"Miss/Mary Dore/Died 6<sup>th</sup> May/1817/Aged 4 Years & 3 Months"*

Fabric lead  ormolou  brass  tin plated pewter  gilt tin   
 iron  silvered tin  enamelled  other ..... *infant.* Sample Ret.

Shape of dep. plate

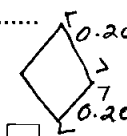
square  rectangle  shield  tapered  lozenge   
 cartouche  oval  other ..... 

Upholstery

colour ..... shoddy  velvet  other ..... Sample Ret.

Construction

butt joint  mitred  pitched  other .....

Grip plate  Fabric = ormolou  brass  tin plated pewter  gilt tin   
 iron  silvered tin  enamelled  other ..... Sample Ret.

Grip  Fabric = ormolou  brass  iron  *x2* Sample Ret.

Design swag of rose  horseshoe  cherub's head  *(A's)* plain   
 other .....

Grip bolts  Corner bolts  Type = gilt brass  brass  iron   
 other ..... Sample Ret.

Lid motifs  other ..... Sample Ret.

Escutcheons  other ..... Sample Ret.

Upholstery nails  brass  gilt brass  silvered brass  iron  enamelled   
 other ..... Sample Ret.

Fixings  panel nails  screws  hinges  lace  Sample Ret.

Timber type ..... Sample Ret.

Interpretation / Comments

.....  
 .....

db

SITE <u>ocb 00</u>		COFFIN RECORD SHEET	CONTEXT NO. <u>842</u>
Trench:	Additional sheets: <u>YES x1</u>	Treatment:	
Site sub-div: <u>CAMP, 6M2 VAULT 26</u>	Grave fills	<u>Necklaces</u>	
Plan no: <u>7</u>	Grave cut:	Finds None <input checked="" type="checkbox"/>	
Section no:	Skeleton:	Breastplate Grip	
Co-ordinates:	Matrix location: <u>840</u> <u>842</u>	Hinge Bracket	
Levels	Preservation: <u>Good</u>	Fixing nails Shroud pins	
Slide No.	Neg No:	Fabric Other finds	

**Description** E-W ADULT BURIAL. NO LINED COFFIN SOLDERED TOP & BASE. TRACES OF OUTER WOOD PRESENT. Pb SOLDERED I.O. PLATE ON BREAST OF COFFIN. FOOT/HEAD PLATE PRESENT, UNSURE OF ITS LOCATION ON COFFIN (PINNED TO OUTER WOOD) WITHIN VAULT

**Discussion** 26

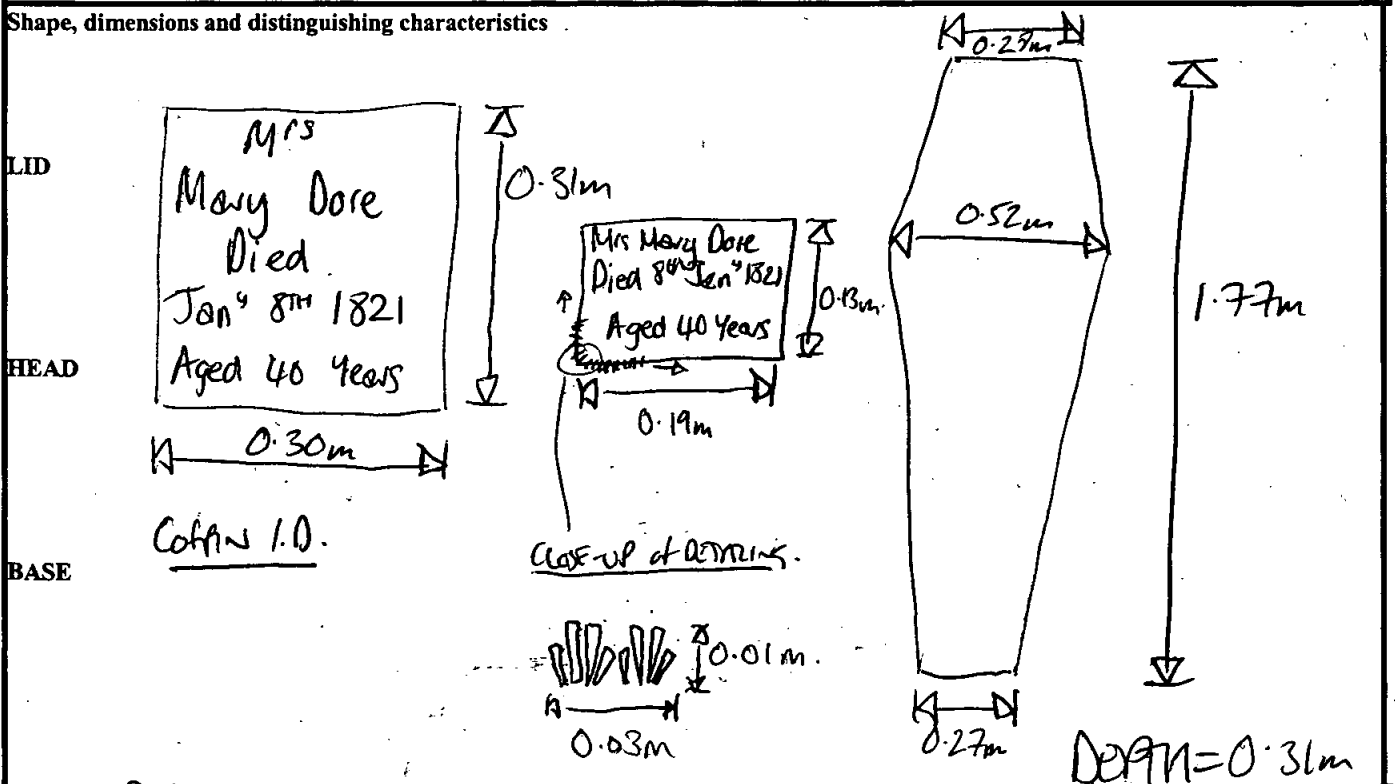

Recorder: SM Date: 01/11/00 Initials:

Site Code

Context

**Outer Coffin**

Sample Ret.

*2100*

*842*

Recording Date ..... *1/11/00* .....

Associated Numbers .....

Condition ..... *3* ..... <sup>*foot/head*</sup> Dep. Plate  Legible

Inscription *"Mrs Mary Dore / Died 8th Jan 1821 / Aged 40 Years"*

Fabric lead  ormolou  brass  tin plated pewter  gilt tin   
iron  silvered tin  enamelled  other ..... Sample Ret.

**Shape of dep. plate**

square  rectangle  shield  tapered  lozenge   
cartouche  oval  other .....

**Upholstery**

colour ..... shoddy  velvet  other ..... Sample Ret.

**Construction**

butt joint  mitred  pitched  other .....

Grip plate  Fabric = ormolou  brass  tin plated pewter  gilt tin   
iron  silvered tin  enamelled  other ..... *frag on rev of grip* Sample Ret.

Grip  Fabric = ormolou  brass  iron  *X1* Sample Ret.

Design swag of rose  horseshoe  cherub's head  *(A)* plain   
other .....

Grip bolts  Corner bolts  Type = gilt brass  brass  iron   
other ..... Sample Ret.

Lid motifs  other ..... Sample Ret.

Escutcheons  other ..... Sample Ret.

Upholstery nails  brass  gilt brass  silvered brass  iron  enamelled   
other ..... Sample Ret.

Fixings  panel nails  screws  hinges  lace  Sample Ret.

Timber type ..... Sample Ret.

**Interpretation / Comments**

.....  
.....

db

SITE		COFFIN RECORD SHEET		CONTEXT NO. 843	
Trench:	Additional sheets: YED X1	Treatment: → NE NEOLITHIC			
Site sub-div: CRAPT, BA12 VAULT 26	Grave fills	<del>XXXXXXXXXXXXXXXXXXXX</del>			
Plan no: 7	Grave cut:	Finds None			
Section no:	Skeleton: G001	Breastplate ✓ Grip			
Co-ordinates:	Matrix location: (84) (85)	Hinge Bracket			
Levels	Preservation: Poor	Fixing nails Shroud pins			
Slide No.	Neg No:	Fabric Other finds			

**Description** → W ADULT BURIAL WITHIN VAULT (26). PD LINED, PINNED SIDES, SOLDERED TOP & BASE. BREASTPLATE PRESENT (BRASS? LEAD) AND SOLDERED I.O. PLATE ON BREAST OF COFFIN.

**Discussion**

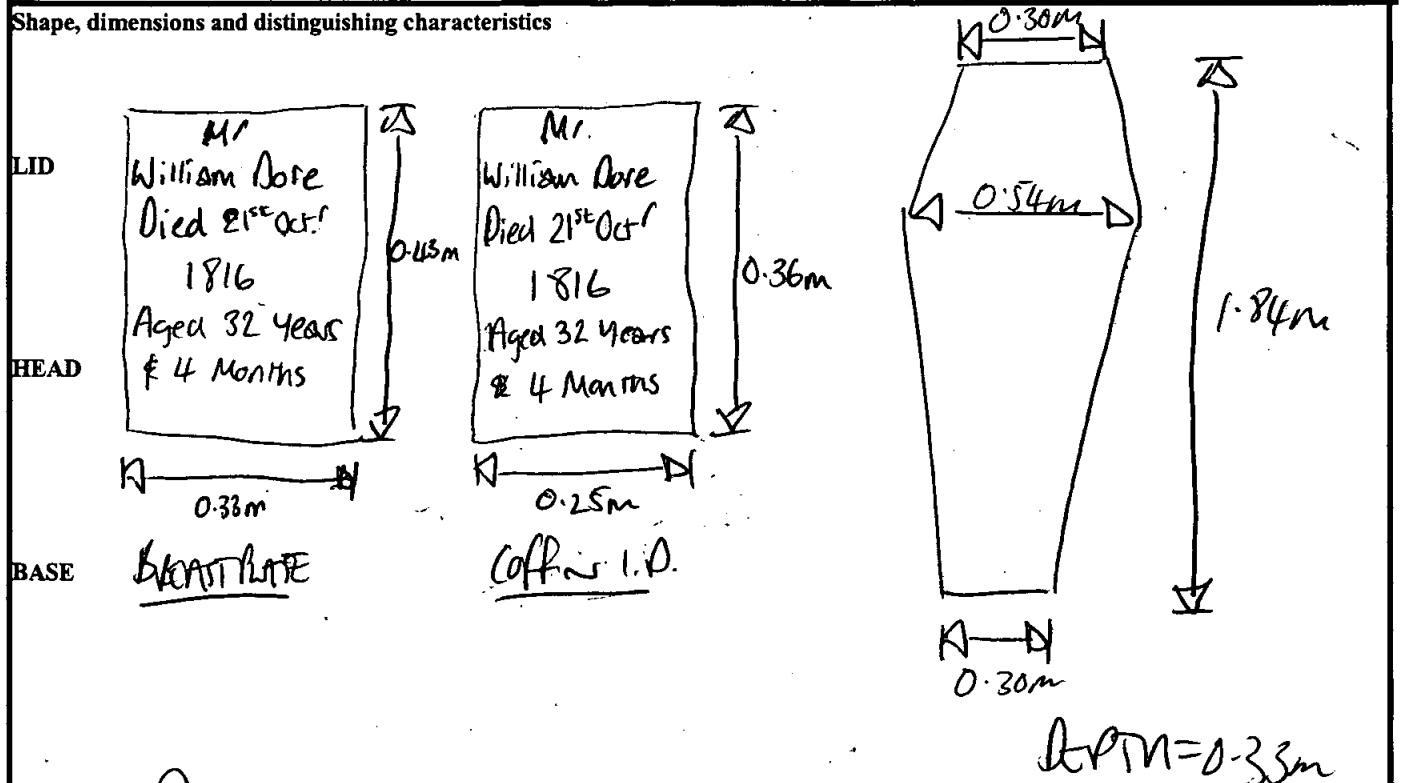

Recorder: *BM* Date: 01/11/00 Initials:

# Coffin Recording Sheet

Site Code

Context

04200

843

**Outer Coffin**

Sample Ret.

Recording Date ..... 1/11/00

Associated Numbers .....

Condition ..... 2

Dep. Plate

Legible

Inscription "Mr / William Dore / Died 21<sup>st</sup> Oct<sup>r</sup> / 1816 / Aged 32 Yrs / & 4 Mon:

Fabric lead  ormolou  brass  tin plated pewter  gilt tin   
 iron  silvered tin  enamelled  other ..... Sample Ret.

**Shape of dep. plate**

square  rectangle  shield  tapered  lozenge   
 cartouche  oval  other ..... *gilded p.b. (B) w/ 362 bottom*

**Upholstery**

colour ..... shoddy  velvet  other ..... Sample Ret.   
*a 352 (inner) outer border.*

**Construction**

butt joint  mitred  pitched  other .....

**Grip plate**

Fabric = ormolou  brass  tin plated pewter  gilt tin   
 iron  silvered tin  enamelled  other ..... Sample Ret.   
*leags on lev. of grip.*

**Grip**

Fabric = ormolou  brass  iron  x1 Sample Ret.

**Design**

swag of rose  horseshoe  cherub's head  (1) conc. plain

other .....

**Grip bolts**

Corner bolts  Type = gilt brass  brass  iron

other ..... Sample Ret.

**Lid motifs**

other ..... Sample Ret.

**Escutcheons**

other ..... Sample Ret.

**Upholstery nails**

brass  gilt brass  silvered brass  iron  enamelled

other ..... Sample Ret.

**Fixings**

panel nails  screws  hinges  lace  Sample Ret.

**Timber type** .....

Sample Ret.

**Interpretation / Comments**

.....  
 .....

db

SITE	COFFIN RECORD SHEET	CONTEXT NO.
OUR00		844
Trench:	Additional sheets:	Treatment:
Site sub-div: U4P1, B4M2	Grave fills	→ NEOLITHIC
Plan no: 7	Grave cut:	Finds None ✓
Section no:	Skeleton:	Breastplate Grip
Co-ordinates:	Matrix location: 844	Hinge Bracket
Levels	Preservation: GOOD	Fixing nails Shroud pins
Slide No.	Neg No:	Fabric Other finds

**Description**  
 N-S ADULT BURIAL. Pb LINEN COFFIN TOP & BASE SOLID. Pb COFFIN I.D. PLATE SCORDED TO BREAST OF COFFIN AND APPEARS TO BE ~~PAINTED~~ LAQUERED BLACK?  
**Discussion**

Shape, dimensions and distinguishing characteristics

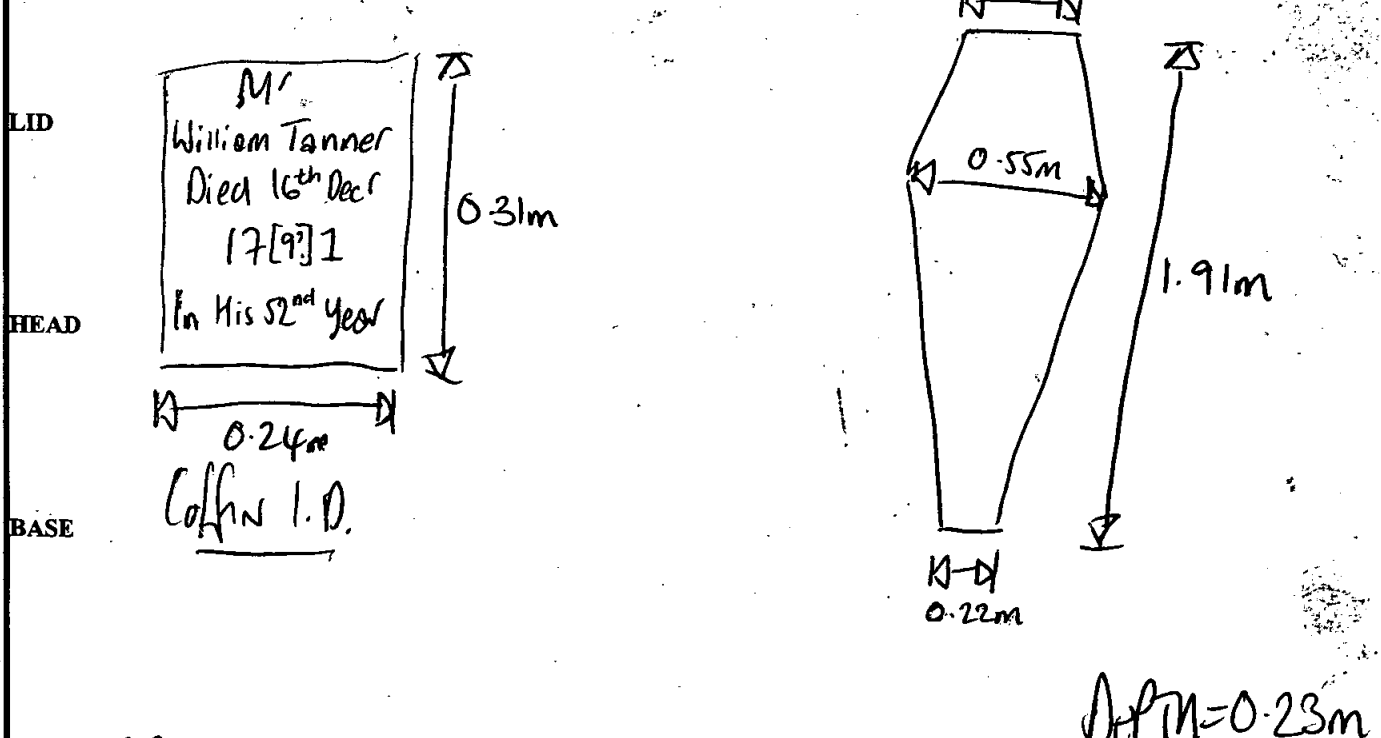

Recorder: <i>BM</i>	Date: 05/11/00	Initials:
---------------------	----------------	-----------



SITE	COFFIN RECORD SHEET	CONTEXT NO.
OLK00		845
Trench:	Additional sheets: YES X2	Treatment: NO TEETH
Site sub-div: C44PT, BM2	Grave fills	BONE/DNA COLLECTED
Plan no: 7	Grave cut:	Finds None
Section no:	Skeleton:	Breastplate ✓ Grip
Co-ordinates:	Matrix location: 845	Hinge Bracket
Levels	Preservation: Poor	Fixing nails Shroud pins
Slide No.	Neg No:	Fabric Other finds

**Description** E-W ADULT BURIAL. Pb lined coffin SOLIDWOOD NOT  
 \$ DATE. TRACES OF OVEN WOOD COFFIN PRESENT HOWEVER NO BREAST-  
 -PLATE OR HEADPLATE PRESENT, SUGGESTING INTERMEDIATE COEN.  
**Discussion** MAJOR. Coffin I.D. Plate engraved and coffin breast-  
 ↓  
 BREASTPLATE FOUND AT HEAD of coffin

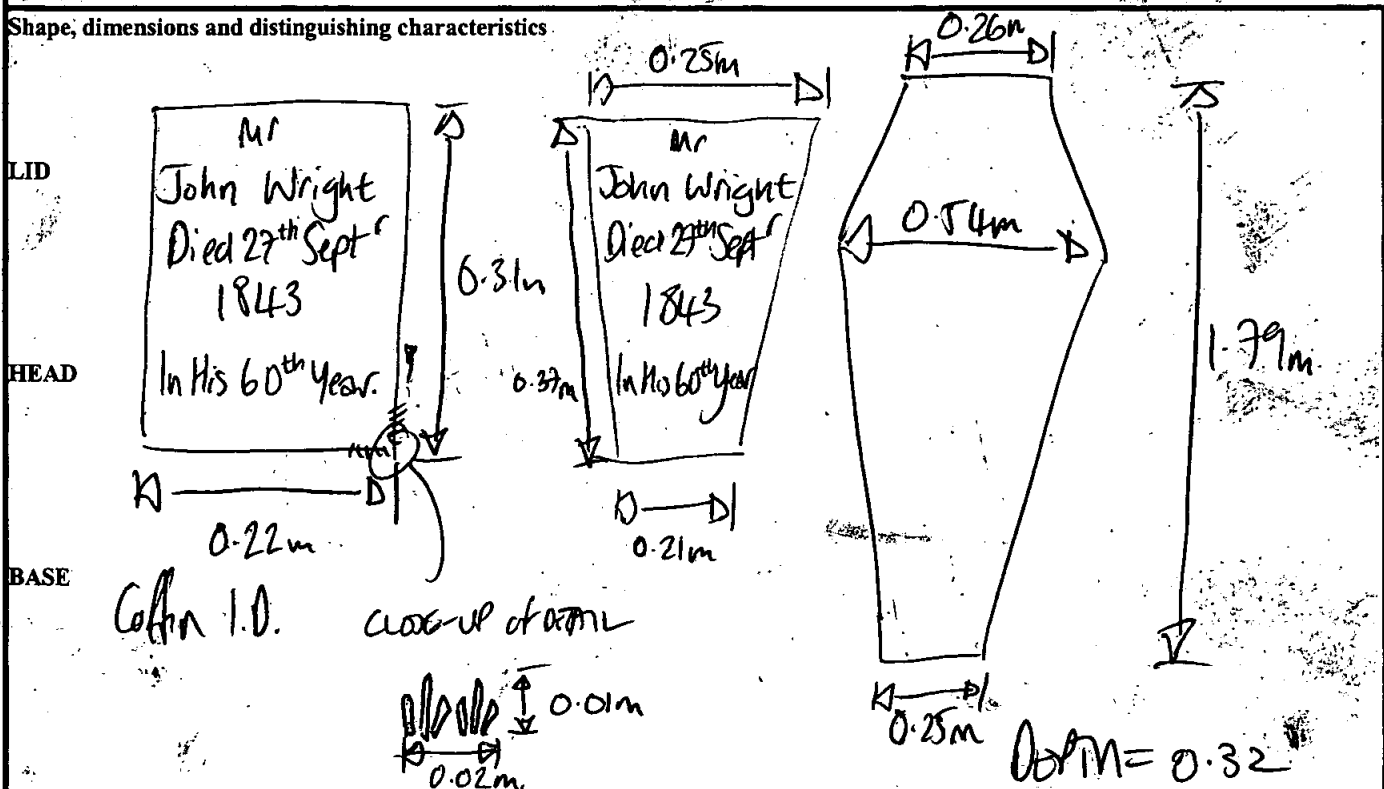

Recorder: *[Signature]* Date: 01/11/00 Initials:

# Coffin Recording Sheet

Site Code

Context

OH200

845

Outer Coffin

Sample Ret.

Recording Date .....

Associated Numbers .....

Condition 3

Dep. Plate

Legible

Inscription "Mr John Weight / Died 27<sup>th</sup> Sep<sup>1843</sup> / 1843 / In his 66<sup>th</sup> Year"

Fabric lead  ormolou  brass  tin plated pewter  gilt tin   
 iron  silvered tin  enamelled  other ..... Sample Ret.   
*black polished.*

Shape of dep. plate

square  rectangle  shield  tapered  lozenge   
 cartouche  oval  other .....

Upholstery

colour ..... shoddy  velvet  other ..... Sample Ret.

Construction

butt joint  mitred  pitched  other .....

Grip plate  Fabric = ormolou  brass  tin plated pewter  gilt tin   
 iron  silvered tin  enamelled  other ..... Sample Ret.

Grip  Fabric = ormolou  brass  iron  Sample Ret.

Design swag of rose  horseshoe  cherub's head  *too conc to id.* plain   
 other .....

Grip bolts  Corner bolts  Type = gilt brass  brass  iron   
 other ..... Sample Ret.

Lid motifs  other ..... Sample Ret.

Escutcheons  other ..... Sample Ret.

Upholstery nails  brass  gilt brass  silvered brass  iron  enamelled   
 other ..... Sample Ret.

Fixings  panel nails  screws  hinges  lace  Sample Ret.

Timber type ..... Sample Ret.

Interpretation / Comments

.....  
 .....

SITE 04200		COFFIN RECORD SHEET	CONTEXT NO. 846
Trench:	Additional sheets:	Treatment:	
Site sub-div: CRMT BAY 2	Grave fills	BONES / DNA	
Plan no: 7	Grave cut:	Finds	
Section no:	Skeleton:	None	
Co-ordinates:	Matrix location: U/L 783	Breastplate ✓	
Levels	Preservation: POOR	Grip	
Slide No.	Neg No:	Hinge	
		Bracket	
		Fixing nails	
		Shroud pins	
		Fabric	
		Other finds	

**Description** Pb Coffin - EAST-WEST ADULT. SOLDERED / OUTER COFFIN TRACES

**Discussion** BRANNED. THE SKELE WELL PRESERVED.

Mrs Elizabeth Lorimer  
Died 29<sup>th</sup> Jan'y  
1850  
Aged 60 years

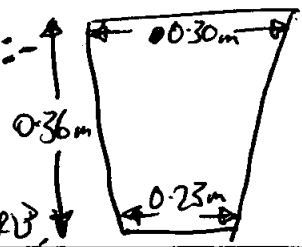

**Shape, dimensions and distinguishing characteristics**

Inscription on Pb Coffins-

LID  
HEAD  
BASE

Mrs Elizabeth  
Lorimer  
Died 29<sup>th</sup> Jan'y  
1850  
Aged 60 years

DEPTH: 0.36m

Recorder: *AM* Date: 1.11.00 Initials:

**Outer Coffin**

Sample Ret.

Site Code

Context

Recording Date ..... 20/2/01 .....

OLR00

846

Associated Numbers .....

Condition ..... 3 .....

Dep. Plate

Legible

Inscription "Mrs Elizabeth Lorimer / Died 29<sup>th</sup> Jan'y / 1850 / Aged 68 Years"  
*new type-sheet.*

Fabric lead  ormolou  brass  tin plated pewter  gilt tin   
iron  silvered tin  enamelled  other ..... Sample Ret.   
*black polished.*

**Shape of dep. plate**

square  rectangle  shield  tapered  lozenge   
cartouche  oval  other .....

**Upholstery**

colour ..... shoddy  velvet  other ..... Sample Ret.

**Construction**

butt joint  mitred  pitched  other .....

Grip plate  Fabric = ormolou  brass  tin plated pewter  gilt tin   
iron  silvered tin  enamelled  other ..... Sample Ret.

Grip  Fabric = ormolou  brass  iron  Sample Ret.

Design swag of rose  horseshoe  cherub's head  plain

other .....

Grip bolts  Corner bolts  Type = gilt brass  brass  iron

other ..... Sample Ret.

Lid motifs  other ..... Sample Ret.

Escutcheons  other ..... Sample Ret.

Upholstery nails  brass  gilt brass  silvered brass  iron  enamelled

other ..... Sample Ret.

Fixings  panel nails  screws  hinges  lace  Sample Ret.

Timber type ..... Sample Ret.

**Interpretation / Comments**

.....  
.....

SITE <i>02100</i>	COFFIN RECORD SHEET	CONTEXT NO. <i>847</i>
Trench:	Additional sheets:	Treatment: <i>BONES LIFTED - UNNAMED</i>
Site sub-div: <i>CHURCH BAY</i>	Grave fills:	
Plan no: <i>7</i>	Grave cut:	Finds None <input checked="" type="checkbox"/>
Section no:	Skeleton: <i>- BAD PRESERVATION IN PLACES</i>	Breastplate Grip
Co-ordinates:	Matrix location:	Hinge Bracket
Levels	Preservation: <i>POOR - CORRODED + CONCRETE NA'S</i>	Fixing nails Shroud pins
Slide No.	Neg No:	Fabric Other finds

Description *16 Coffin - SOLDERED.  
WEST-EAST-~~W~~ BURIAL  
NO NAME*

Discussion *BRANNED.*      *OUTER COFFIN TRACES*

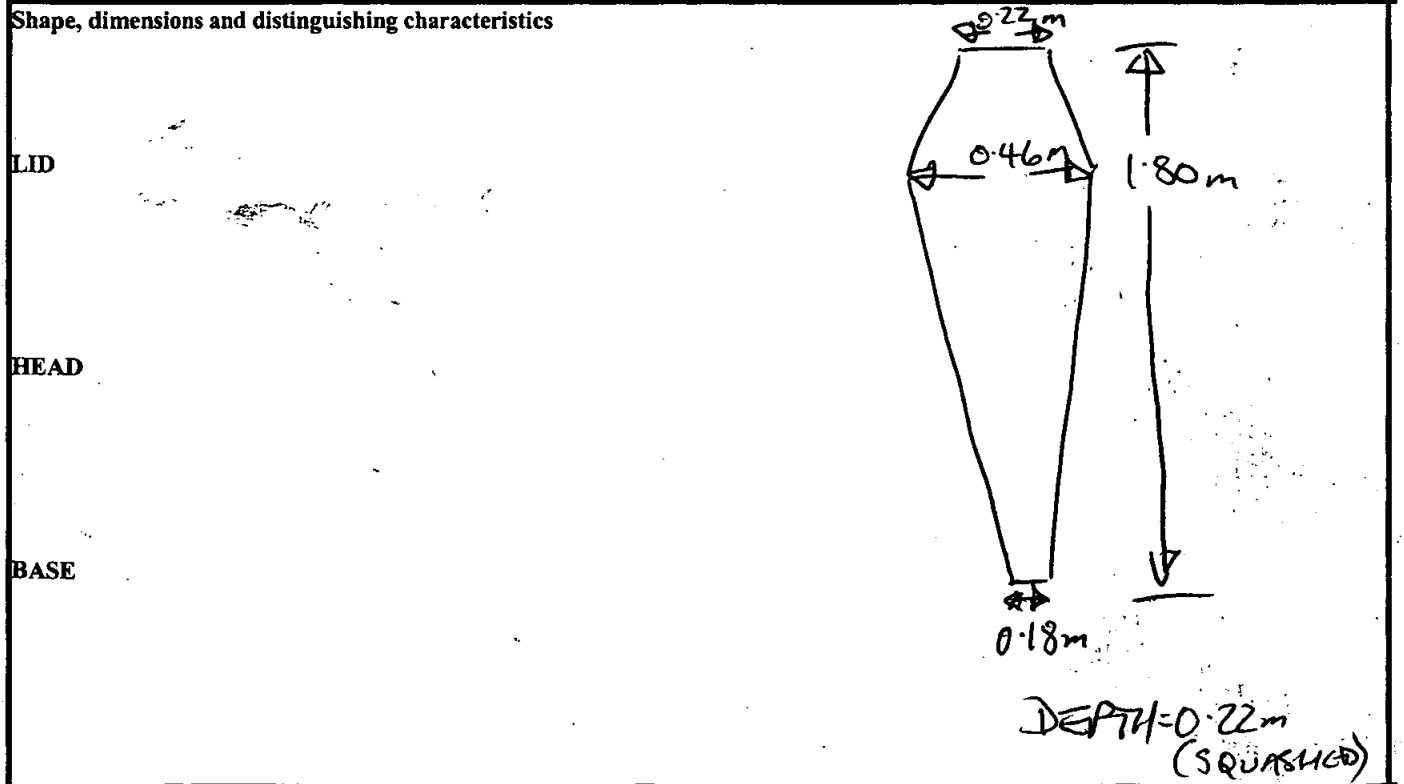

Recorder: <i>M</i>	Date: <i>1.11.00</i>	Initials:
--------------------	----------------------	-----------

SITE	COFFIN RECORD SHEET	CONTEXT NO.
OLROO.		848.
Trench:	Additional sheets:	Treatment:
Site sub-div: GRIFT BAR 2	Grave fills	BONES LIFTED NO NAME.
Plan no: 7	Grave cut:	Finds
Section no:	Skeleton:	None ✓
Co-ordinates:	Matrix location:	Breastplate
Levels	Preservation: good.	Grip
Slide No.	Neg No:	Hinge
		Bracket
		Fixing nails
		Shroud pins
		Fabric
		Other finds

**Description** Pb Coffin. - SOLDERED.  
WEST-EAST ADULT BURIAL

**Discussion** NO NAME - INSCRIPTION ILLEGIBLE  
BRANDED OUTER COFFIN TRACES.

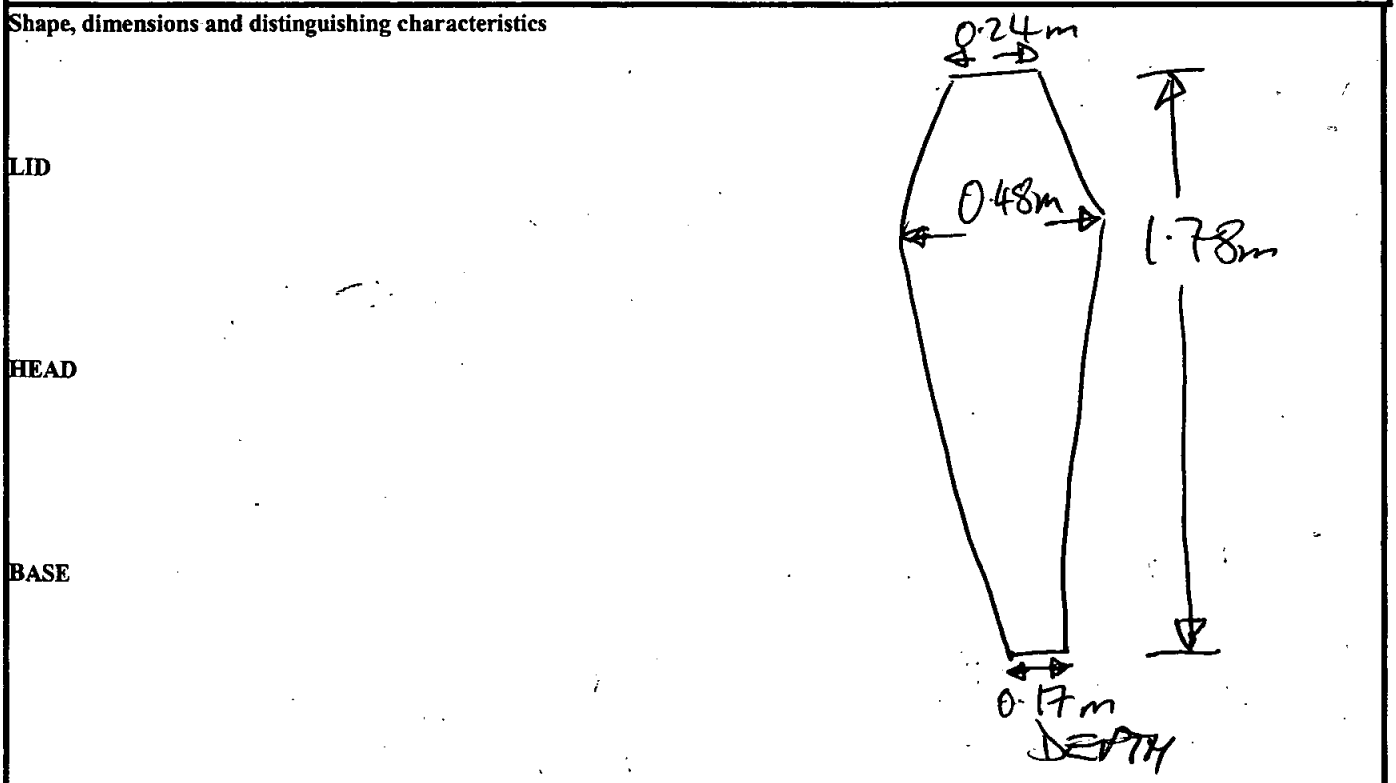

Recorder: <i>TM</i>	Date: 1-11-00	Initials:
---------------------	---------------	-----------

db

SITE OL100	COFFIN RECORD SHEET	CONTEXT NO. 849
Trench:	Additional sheets:	Treatment: INTACT. → NEOLITHIC.
Site sub-div: CHURCH BAY 2.	Grave fills:	
Plan no: 7.	Grave cut:	Finds None ✓
Section no:	Skeleton:	Breastplate Grip
Co-ordinates:	Matrix location:	Hinge Bracket
Levels:	Preservation: GOOD.	Fixing nails Shroud pins
Slide No.:	Neg No.:	Fabric Other finds

Description Pb ADULT COFFIN. - SOLDERED.  
NAMED

Discussion EAST-WEST BURIAL  
TRACES OF OUTER WOOD COFFIN

Shape, dimensions and distinguishing characteristics

Inscribed Pb inner plate:-

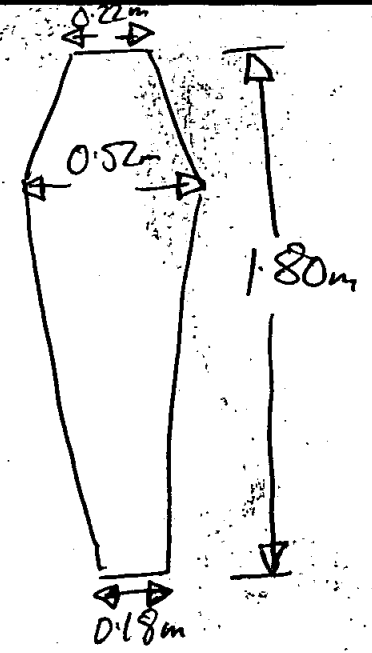
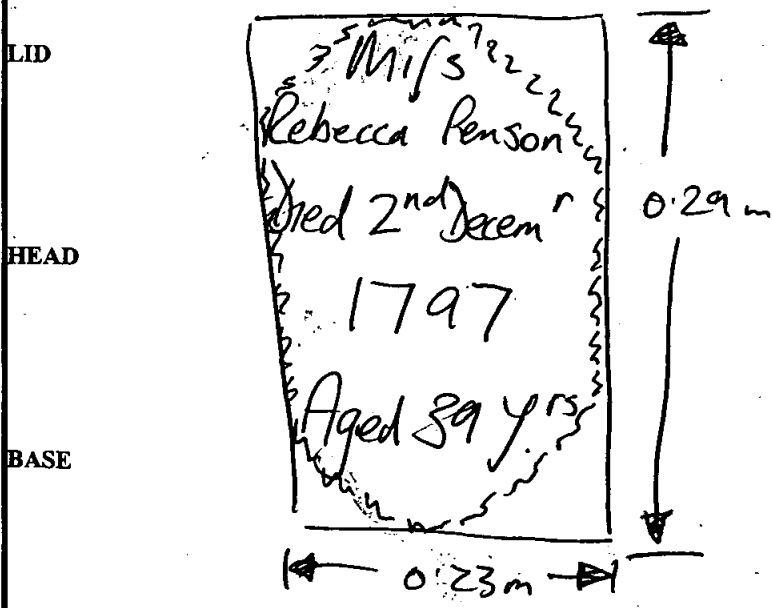

DEPTH. 0.32m

Recorder: TM	Date: 1.11.00	Initials:
-----------------	------------------	-----------

SITE	COFFIN RECORD SHEET	CONTEXT NO.
02 00		850
Trench:	Additional sheets:	Treatment:
Site sub-div: adult, BM3	Grave fills	Bone Collected.
Plan no: 7	Grave cut:	Finds None ✓
Section no:	Skeleton:	Breastplate Grip
Co-ordinates:	Matrix location: 357 763 850	Hinge Bracket
Levels	Preservation: poor	Fixing nails Shroud pins
Slide No.	Neg No:	Fabric Other finds

**Description** W → E ADULT BURIAL. 1/2 LINING COFFIN SOLDERED TOP & SIDE. TRACES OF WOOD PRESENT. Pb BONY REMAINS - NAME I.D. ENGRAVED VIRTUALLY NON-EXISTANT. CONTENTS BURNED

**Discussion**

**Shape, dimensions and distinguishing characteristics**

LID

NO NAME

HEAD

BASE

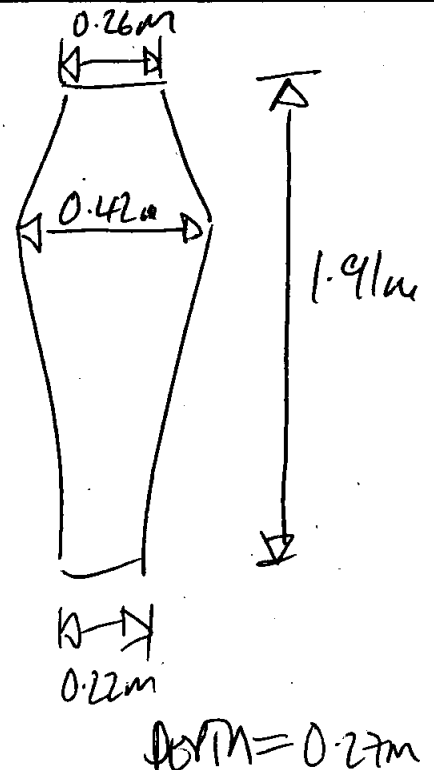

Recorder: PBM

Date: 02/11/00

Initials:



SITE OLR 00	COFFIN RECORD SHEET	CONTEXT NO. 851
Trench:	Additional sheets:	Treatment:
Site sub-div: C4491, BX4 3	Grave fills:	Reve/ONA covered.
Plan no.: 7	Grave cut:	Finds None
Section no:	Skeleton: G000	Breastplate ✓ Grip
Co-ordinates:	Matrix location: 767 768 851	Hinge Bracket
Levels:	Preservation: 100%	Fixing nails Shroud pins
Slide No.:	Neg No.:	Fabric Other finds

**Description** E-W ADULT BURIAL. PD LINED COFFIN SPLITTED BY GRAVE. TRACES OF OUTER WOOD PRESERV. Coffin I.P. PLATE SPLITTED TO TOP OF COFFIN BREASTPLATE PINNED TO WOOD-WOOD BREASTPLATE

**Discussion** UNUSUAL? BLACK. CONTENTS BRANNED.

Shape, dimensions and distinguishing characteristics

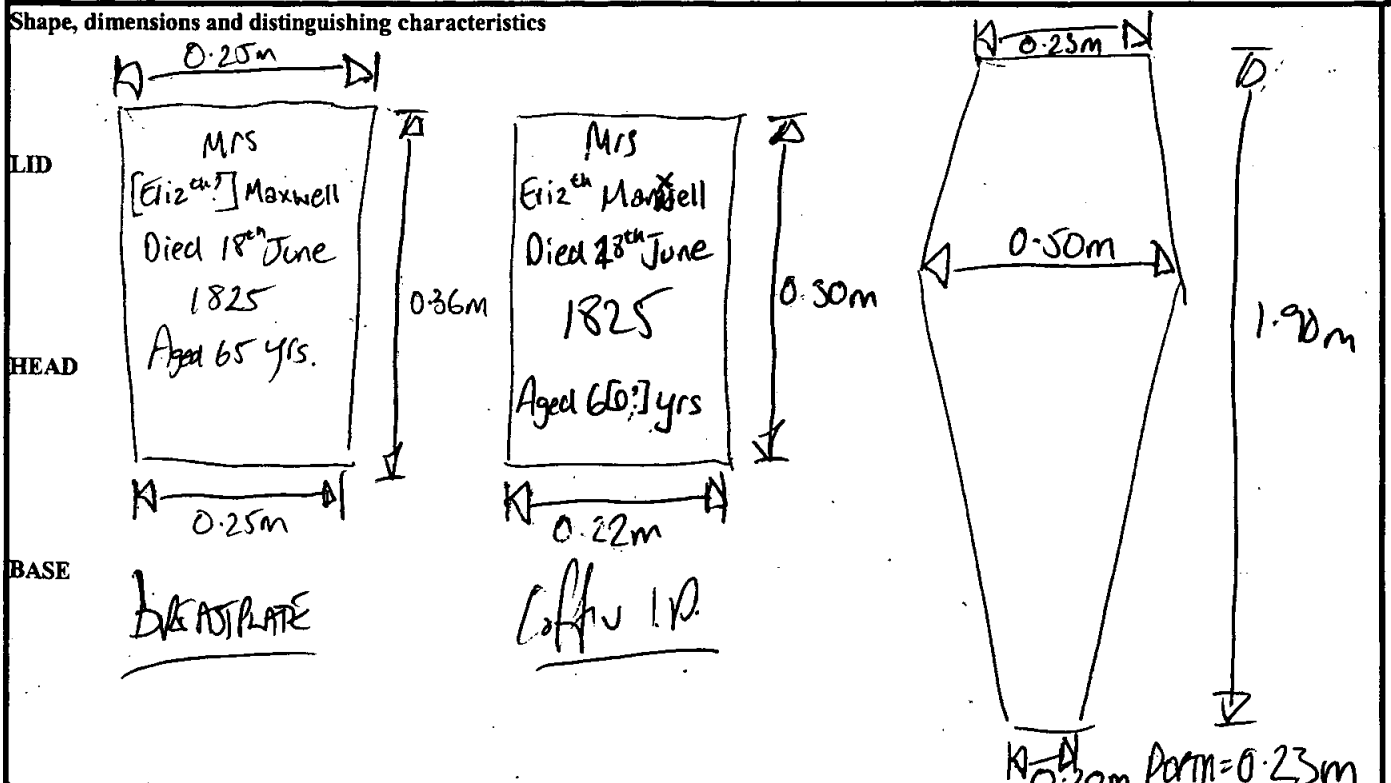

Recorder: *APM* Date: 02/11/06 Initials:

# Coffin Recording Sheet

Site Code

Context

OH00

851

**Outer Coffin**

Sample Ret.

Recording Date ..... 2/11/00 .....

Associated Numbers .....

Condition ..... 2 .....

Dep. Plate

Legible  ish

Inscription "Mrs/... Maxwell/Died 18<sup>th</sup> June/1825/Aged 65 Yrs"

*new type:*

Fabric lead  ormolou  brass  tin plated pewter  gilt tin   
 iron  silvered tin  enamelled  other ..... Sample Ret.

**Shape of dep. plate**

square  rectangle  shield  tapered  lozenge   
 cartouche  oval  other .....

**Upholstery**

colour ..... shoddy  velvet  other ..... Sample Ret.

**Construction**

butt joint  mitred  pitched  other .....

**Grip plate**  Fabric = ormolou  brass  tin plated pewter  gilt tin   
 iron  silvered tin  enamelled  other ..... Sample Ret.

**Grip**  Fabric = ormolou  brass  iron  Sample Ret.

**Design** swag of rose  horseshoe  cherub's head  plain   
 other .....

**Grip bolts**  **Corner bolts**  **Type =** gilt brass  brass  iron

other ..... Sample Ret.

**Lid motifs**  other ..... Sample Ret.

**Escutcheons**  other ..... Sample Ret.

**Upholstery nails**  brass  gilt brass  silvered brass  iron  enamelled   
 other ..... Sample Ret.

**Fixings**  panel nails  screws  hinges  lace  Sample Ret.

**Timber type** ..... Sample Ret.

**Interpretation / Comments**

.....  
 .....

dbb

SITE OLR 00	COFFIN RECORD SHEET	CONTEXT NO. 852
Trench:	Additional sheets:	Treatment: W.B. ONLY TEETH
Site sub-div: CR4A, BM2	Grave fills:	BONE/MIA COLLECTED
Plan no: 7	Grave cut:	Finds None <input checked="" type="checkbox"/>
Section no:	Skeleton: AN.	Breastplate Grip
Co-ordinates:	Matrix location: 852	Hinge Bracket
Levels:	Preservation: HEAVILY DAMAGED	Fixing nails Shroud pins
Slide No.:	Neg No.:	Fabric Other finds

Description: SEN ADULT BURIAL Pb LINED COFFIN, SUPPORTED BY  
 4 BASE. Pb I.D. RATE <sup>ENC. DATED</sup> ~~SEEN~~ TO BREAST OF COFFIN. NO  
 TRACE OF SURROUNDING WOOD.  
 Discussion: CONTENTS BANNED

Shape, dimensions and distinguishing characteristics

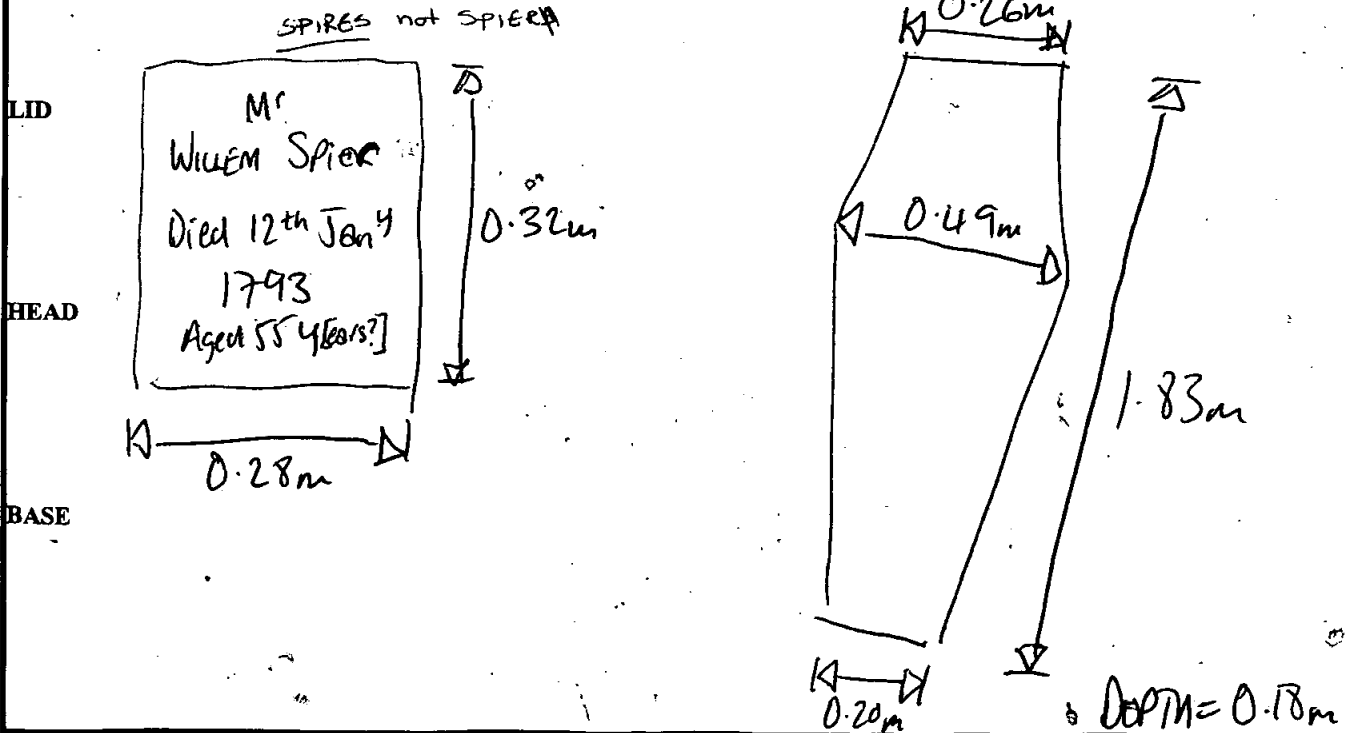

Recorder: *ARM* Date: 02/11/00 Initials:

SITE <u>OLR00</u>		COFFIN RECORD SHEET	CONTEXT NO. <u>853</u>
Trench:	Additional sheets: <u>yes x1</u>	Treatment:	
Site sub-div: <u>ALM1, BR3</u>	Grave fills	<u>None Concrete</u>	
Plan no: <u>7</u>	Grave cut:	Finds	
Section no:	Skeleton: <u>Good</u>	None <del>was</del>	
Co-ordinates:	Matrix location: <u>(765)</u> <u>(853)</u>	Breastplate	
Levels	Preservation: <u>Good</u>	Grip <input checked="" type="checkbox"/>	
Slide No.	Neg No:	Hinge	
		Bracket	
		Fixing nails	
		Shroud pins	
		Fabric	
		Other finds	

Description E-W ADULT BURIAL. Pb lined coffin RP & BASE removed  
Coffin I.D. PLATE PRESENT (SOLDERED) ON BREAST OF COFFIN - NO DEGRADED.  
∴ NO NAME. OUTER WOOD PRESENT.

Discussion

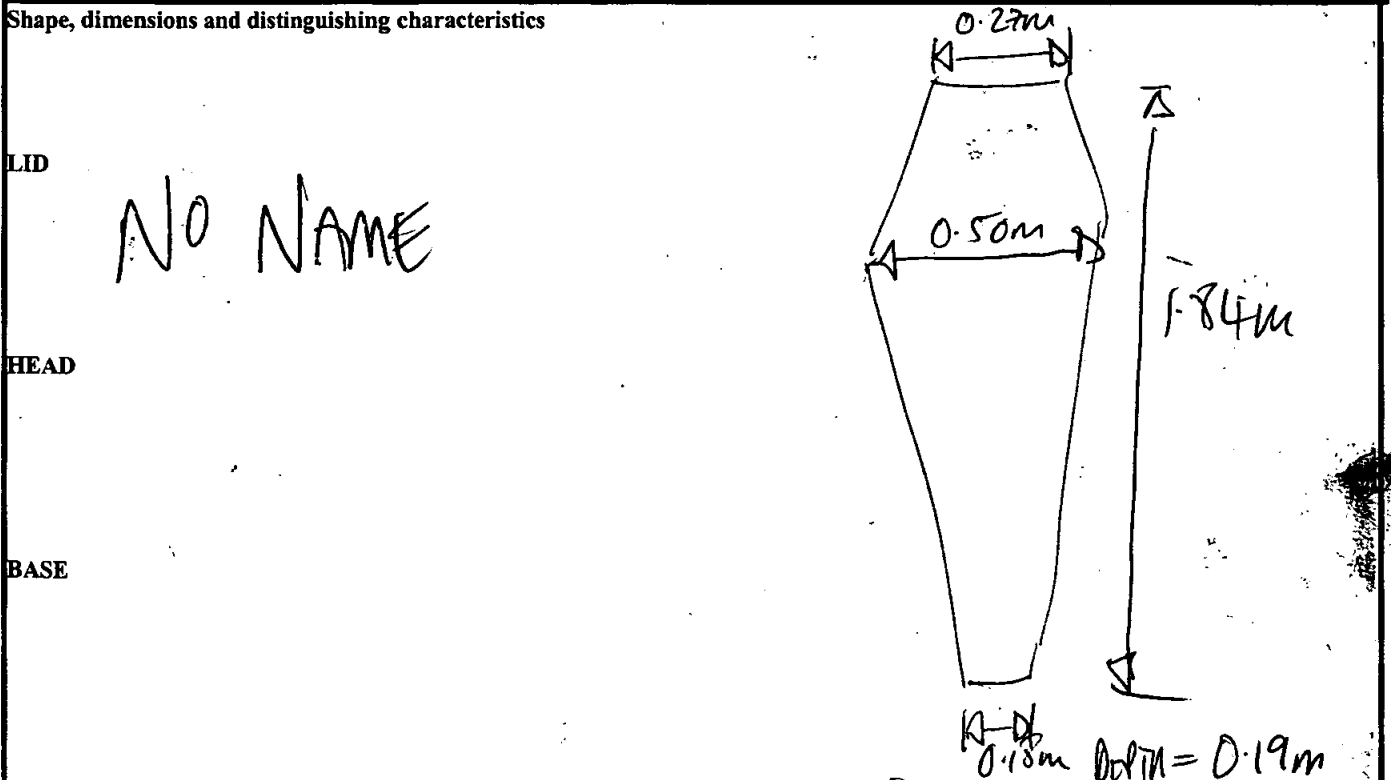

Recorder: <u>AM</u>	Date: <u>02/11/00</u>	Initials:
---------------------	-----------------------	-----------

**Outer Coffin**

Sample Ret.

Site Code

Context

Recording Date ..... 13/2/01 .....

2200

853

Associated Numbers .....

Condition .....

Dep. Plate

Legible

Inscription

**Fabric** lead       ormolou       brass       tin plated pewter       gilt tin   
 iron       silvered tin       enamelled       other .....      Sample Ret.

**Shape of dep. plate**

square       rectangle       shield       tapered       lozenge   
 cartouche       oval       other .....

**Upholstery**

colour .....      shoddy       velvet       other .....      Sample Ret.

**Construction**

butt joint       mitred       pitched       other .....

**Grip plate**       **Fabric =** ormolou       brass       tin plated pewter       gilt tin   
 iron       silvered tin       enamelled       other .....      Sample Ret.

**Grip**  **Fabric =** ormolou       brass       iron  <sup>x2</sup>      Sample Ret.

**Design**      swag of rose       horseshoe       cherub's head  (4)'s      plain   
 other .....

**Grip bolts**       **Corner bolts**       **Type =** gilt brass       brass       iron   
 other .....      Sample Ret.

**Lid motifs**       other .....      Sample Ret.

**Escutcheons**       other .....      Sample Ret.

**Upholstery nails**       brass       gilt brass       silvered brass       iron       enamelled   
 other .....      Sample Ret.

**Fixings**       panel nails       screws       hinges       lace       Sample Ret.

**Timber type** .....      Sample Ret.

**Interpretation / Comments**

.....  
 .....

db

SITE	COFFIN RECORD SHEET	CONTEXT NO.
OC200		854
Trench:	Additional sheets:	Treatment:
Site sub-div: CRUIT, BAM3	Grave fills	→ NEAR/LIS
Plan no: 7	Grave cut:	Finds None ✓
Section no:	Skeleton:	Breastplate
Co-ordinates:	Matrix location: 266 854	Grip
Levels	Preservation: 9000	Hinge
Slide No.	Neg No:	Bracket
		Fixing nails
		Shroud pins
		Fabric
		Other finds

**Description** W-E ADULT BURIAL. NO LINED COFFIN, SCRAPPED TOP & END. OSTER WOOD PRESENT. ENGRAVERS I.P. ON BREAST OF Pb COFFIN, & METAL PLATE LOCATED AT NEAR/LIS - PINNED TO OSTER WOOD.

**Discussion**

**Shape, dimensions and distinguishing characteristics**

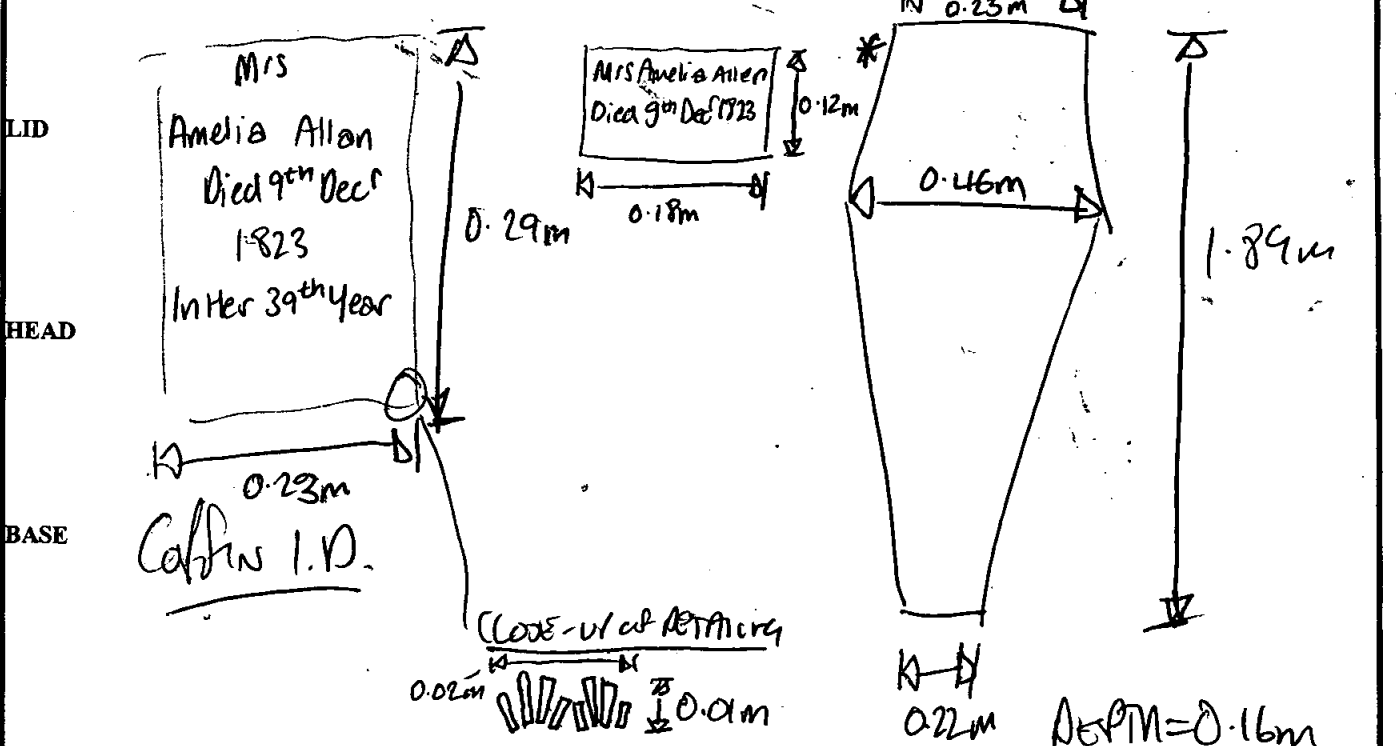

Recorder: *ARM* Date: 02/11/00 Initials:

db

SITE: <u>OL100</u>	COFFIN RECORD SHEET	CONTEXT NO. <u>855</u>
Trench:	Additional sheets:	Treatment:
Site sub-div: <u>OLYPT, GUY'S VAULT A</u>	Grave fills:	<u>Lead/DNA coil</u>
Plan no: <u>7</u>	Grave cut:	Finds: <u>None</u>
Section no:	Skeleton:	Breastplate <input checked="" type="checkbox"/>
Coordinates:	Matrix location: <u>855</u> <u>856</u>	Grip
Levels:	Preservation: <u>Pool</u>	Hinge
Slide No.:	Neg No.:	Bracket
		Fixing nails
		Shroud pins
		Fabric
		Other finds

Description: E-W ADULT BURIAL IN LEAD COFFIN SURVIVED TO 1/2 SIZE. TRACES OF AURAL WOOD NOT PRESENT. NO BREASTPLATE NOT KNOWN TO AURAL WOOD. Pb I.D. PLATE PRESENT, ~~REMOVED~~ ENGRAVED

Discussion: BREAST of coffin. CONTENTS BRANNED

Shape, dimensions and distinguishing characteristics

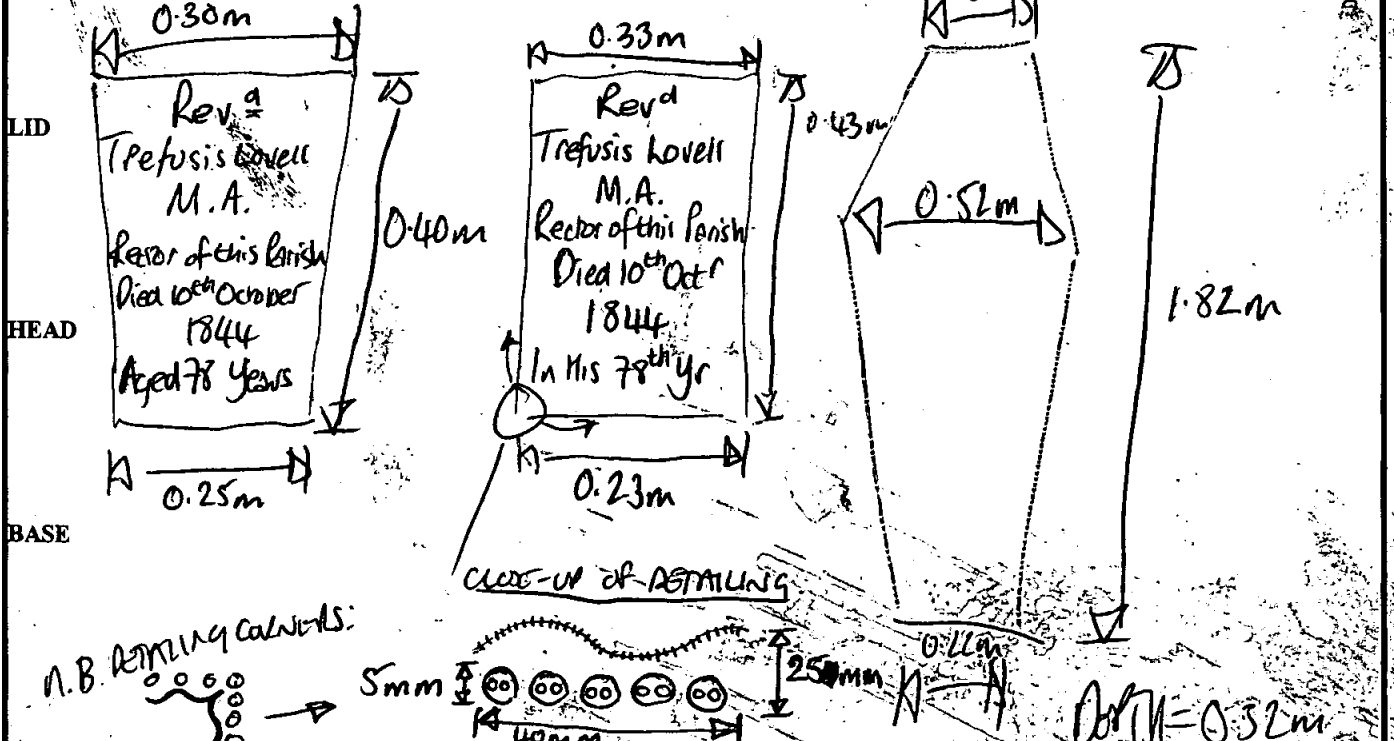

Recorder: [Signature] Date: 04/11/00 Initials: [Signature]

# Coffin Recording Sheet

Site Code

Context

OH200

855

**Outer Coffin**

Sample Ret.

Recording Date ..... 2/11/00 .....

Associated Numbers .....

Condition ..... 3 .....

Dep. Plate

Legible

Inscription "Rev'd / Trefusis Lovell / MA / Rector of this Parish / Died 10<sup>th</sup> Octob<sup>r</sup> / 1844 / Aged 78 y<sup>rs</sup>"

*Some as 776 w/ 534 border. except bottom. see sheet.*

Fabric lead  ormolou  brass  tin plated pewter  gilt tin   
iron  silvered tin  enamelled  other ..... Sample Ret.

**Shape of dep. plate**

square  rectangle  shield  tapered  lozenge   
cartouche  oval  other ..... *black polished.*

**Upholstery**

colour ..... shoddy  velvet  other ..... Sample Ret.

**Construction**

butt joint  mitred  pitched  other .....

Grip plate  Fabric = ormolou  brass  tin plated pewter  gilt tin   
iron  silvered tin  enamelled  other ..... Sample Ret.

Grip  Fabric = ormolou  brass  iron  Sample Ret.

Design swag of rose  horseshoe  cherub's head  plain   
other .....

Grip bolts  Corner bolts  Type = gilt brass  brass  iron   
other ..... Sample Ret.

Lid motifs  other ..... Sample Ret.

Escutcheons  other ..... Sample Ret.

Upholstery nails  brass  gilt brass  silvered brass  iron  enamelled   
other ..... Sample Ret.

Fixings  panel nails  screws  hinges  lace  Sample Ret.

Timber type ..... Sample Ret.

**Interpretation / Comments**

.....  
.....



ORR00

855  
Cent.

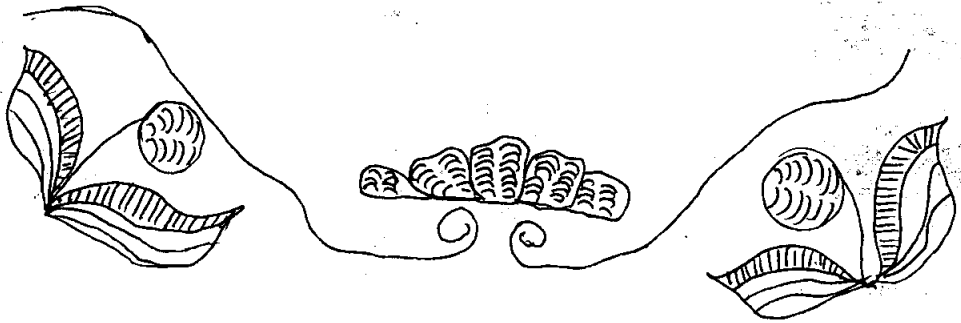

db.

SITE <b>AR00</b>	COFFIN RECORD SHEET	CONTEXT NO. <b>856</b>
Trench:	Additional sheets:	Treatment:
Site sub-div: <b>CRUPT, BM 3 VAULT 19</b>	Grave fills:	<b>None/DNA collected.</b>
Plan no: <b>7</b>	Grave cut:	Finds
Section no:	Skeleton:	None
Coordinates:	Matrix location: <b>(855)</b> <b>(856)</b>	Breastplate <input checked="" type="checkbox"/>
Levels:	Preservation: <b>Poor</b>	Grip
Slide No:	Neg No:	Hinge
		Bracket
		Fixing nails
		Shroud pins
		Fabric
		Other finds

**Description** E-W ADULT BURIAL. Pb lined coffin soldered. No base TRACES of wood. NOT PRESENT. BREASTPLATE LOCATED AT **(855)** NEXT TO BURIALS WITHIN VAULT (9). POSS. COFFINS RE-LOCATED

**Discussion** WITHIN VAULT AFTER BEING KEPT ELSEWHERE. COFFIN I.D. ENGRAVED TO BREAST OF COFFIN.

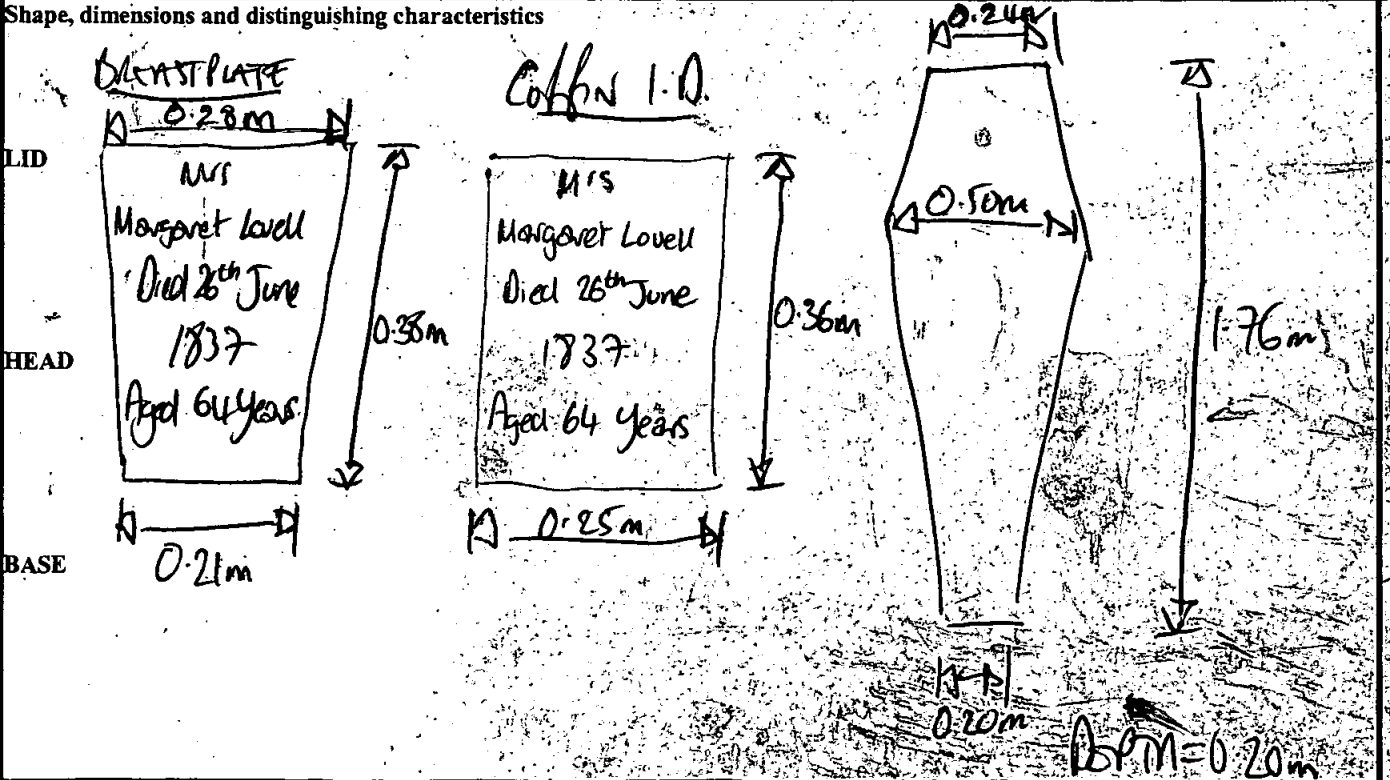

Recorder: **AM** Date: **02/11/00** Initials:

# Coffin Recording Sheet

**Outer Coffin**

Sample Ret.

Site Code

Context

Recording Date ..... 3/11/00 .....

OH200

856

Associated Numbers .....

Condition ..... 3 .....

Dep. Plate

Legible

Inscription "Mrs Margaret Lovell / Died 25 June / 1837 / Aged 64 Yrs" *new type - see over.*

Fabric lead  ormolou  brass  tin plated pewter  gilt tin   
 iron  silvered tin  enamelled  other ..... Sample Ret.

**Shape of dep. plate**

square  rectangle  shield  tapered  lozenge   
 cartouche  oval  other ..... *Block polished*

**Upholstery**

colour ..... shoddy  velvet  other ..... Sample Ret.

**Construction**

butt joint  mitred  pitched  other .....

Grip plate  Fabric = ormolou  brass  tin plated pewter  gilt tin   
 iron  silvered tin  enamelled  other ..... Sample Ret.

Grip  Fabric = ormolou  brass  iron  Sample Ret.

Design swag of rose  horseshoe  cherub's head  plain   
 other .....

Grip bolts  Corner bolts  Type = gilt brass  brass  iron   
 other ..... Sample Ret.

Lid motifs  other ..... Sample Ret.

Escutcheons  other ..... Sample Ret.

Upholstery nails  brass  gilt brass  silvered brass  iron  enamelled   
 other ..... Sample Ret.

Fixings  panel nails  screws  hinges  lace  Sample Ret.

Timber type ..... Sample Ret.

**Interpretation / Comments**

.....  
 .....

dp.

SITE <b>OLR 00</b>	COFFIN RECORD SHEET	CONTEXT NO. <b>857</b>
Trench:	Additional sheets:	Treatment:
Site sub-div: <b>CLM, BMS</b>	Grave fills:	<b>DNA - NO BONE</b>
Plan no: <b>7</b>	Grave cut:	Finds
Section no:	Skeleton:	None <input checked="" type="checkbox"/>
Co-ordinates:	Matrix location: <b>(77)</b> <b>(857)</b>	Breastplate
Levels:	Preservation:	Grip
Slide No.:	Neg No.:	Hinge
		Bracket
		Fixing nails
		Shroud pins
		Fabric
		Other finds

**Description** E-W ADULT BURIAL. Pb LINED COFFIN SLD OPEN (BAND) TOP & BASE. TRACES OF ANTON WOOD PRESERV. ENGRAVED I.P. PLATE ON BREAST OF COFFIN.

**Discussion**

Shape, dimensions and distinguishing characteristics

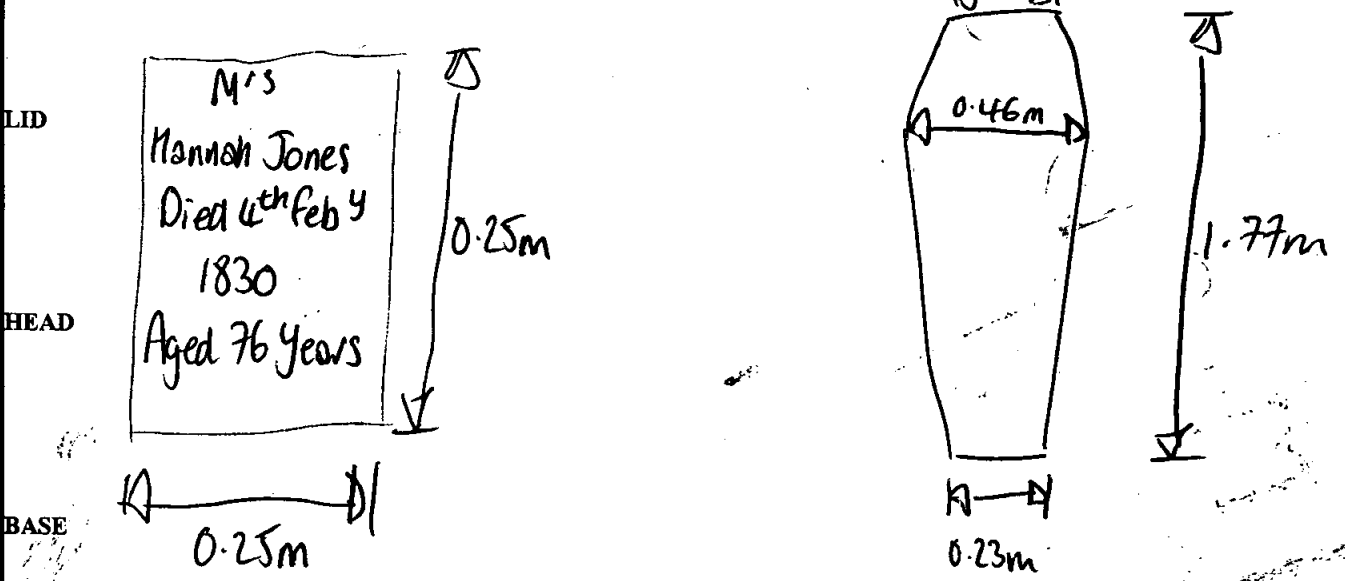

Recorder: <b>JPM</b>	Date: <b>03/11/00</b>	Initials:
----------------------	-----------------------	-----------

db

SITE <u>OLR 00</u>		COFFIN RECORD SHEET	CONTEXT NO. <u>858</u>
Trench:	Additional sheets:	Treatment:	
Site sub-div: <u>OLR PT, BMS</u>	Grave fills	<u>ONA / wood covered</u>	
Plan no: <u>7</u>	Grave cut:	Finds None ✓	
Section no:	Skeleton:	Breastplate Grip	
Co-ordinates:	Matrix location: <u>772</u> <u>773</u> <u>858</u>	Hinge Bracket	
Levels	Preservation:	Fixing nails Shroud pins	
Slide No.	Neg No:	Fabric Other finds	

**Description** W-E ADULT BURIAL. Pb lined coffin, thin band secured top & base. Coffin I.D. engraved to breast of coffin. Traces of outer wood present. Cotton cloth padding resting &

**Discussion** UNDERNEATH SKULL (Pillow?)

Shape, dimensions and distinguishing characteristics

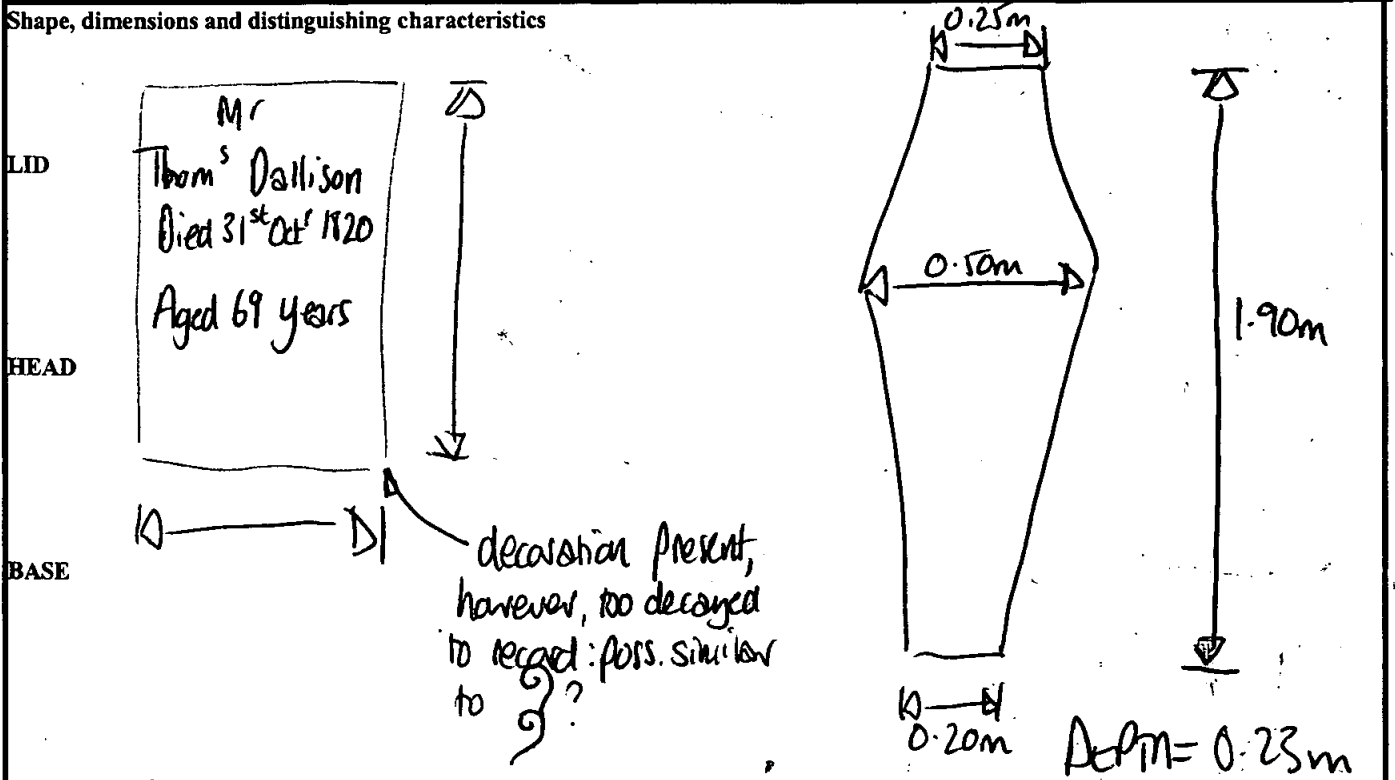

Recorder: <u>DM</u>	Date: <u>03/11/00</u>	Initials:
---------------------	-----------------------	-----------

dp

SITE OLK 00	COFFIN RECORD SHEET	CONTEXT NO. 859
Trench:	Additional sheets:	Treatment:
Site sub-div: CALM, BAM3	Grave fills:	Bone / DNA recovered
Plan no: 7	Grave cut:	Finds
Section no:	Skeleton:	None
Co-ordinates:	Matrix location: 773	Breastplate
Levels	859	Grip
Slide No.	Preservation:	Hinge
		Bracket
		Fixing nails
		Shroud pins
		Fabric
		Other finds

Description E-W ADULT BURIAL IN LINDO COFFIN, PINHEADS SEEN AT TOP & BASE. TRACES OF OUTER WOOD PRESENT. COFFIN I.D. SLOT SEEN AT BREAST OF COFFIN

Discussion

Shape, dimensions and distinguishing characteristics

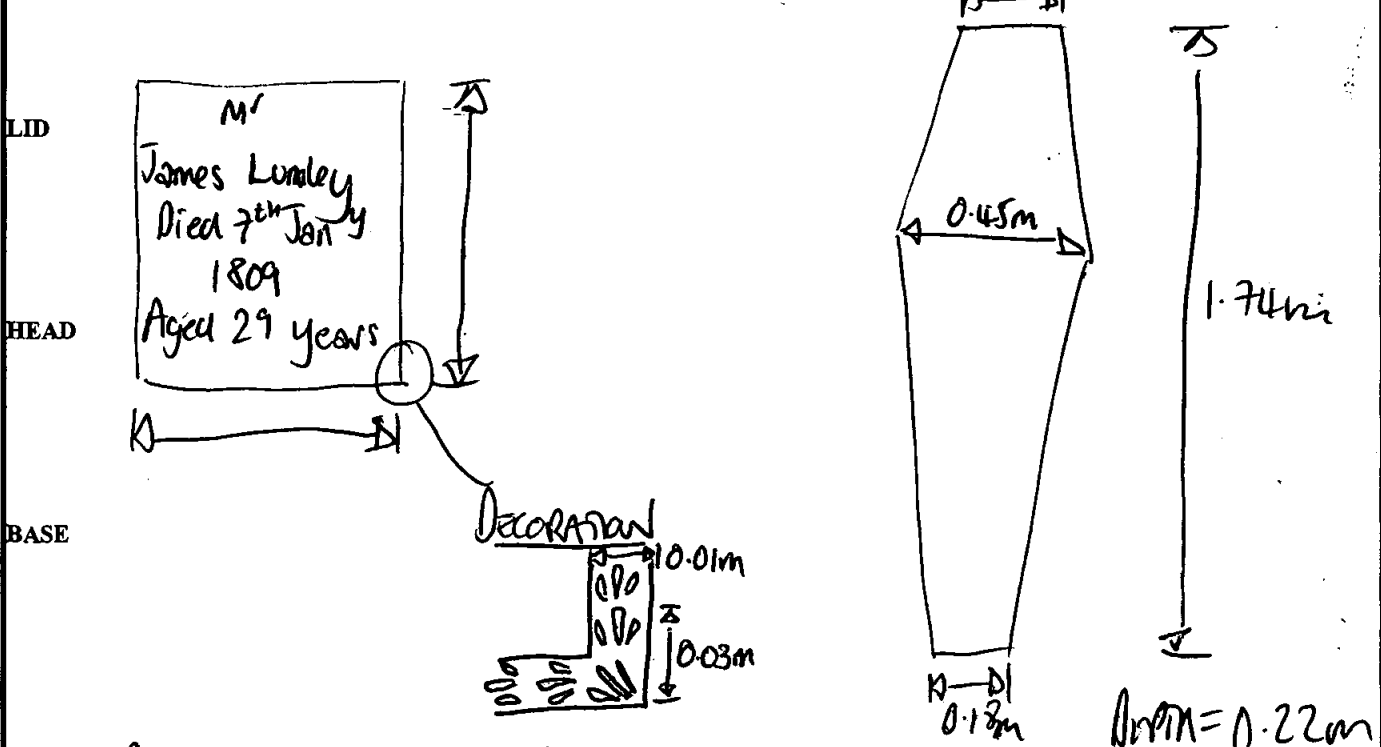

Recorder: <i>AM</i>	Date: 13/11/00	Initials:
---------------------	----------------	-----------

dbb

SITE OL200	COFFIN RECORD SHEET	CONTEXT NO. 860
Trench:	Additional sheets:	Treatment:
Site sub-div: <i>CULT, BAYS</i>	Grave fills:	<i>DNA/Dent Collected</i>
Plan no: <i>7</i>	Grave cut:	Finds None <i>✓</i>
Section no:	Skeleton:	Breastplate Grip <i>✓</i>
Co-ordinates:	Matrix location <i>774 898</i> <i>860</i>	Hinge Bracket
Levels:	Preservation: <i>poor</i>	Fixing nails Shroud pins
Slide No.:	Neg No.:	Fabric Other finds

**Description**  
 E-W ADULT BURIAL. Pb LINCOLN COFFIN, BAND SECURED TOP & BASE. TRACES OF OUTER WOOD PRESENT. Pb COFFIN I.P. SECURED TO BREAST OF COFFIN. CONTENTS BANNED & SUNKEN

**Discussion**

**Shape, dimensions and distinguishing characteristics**

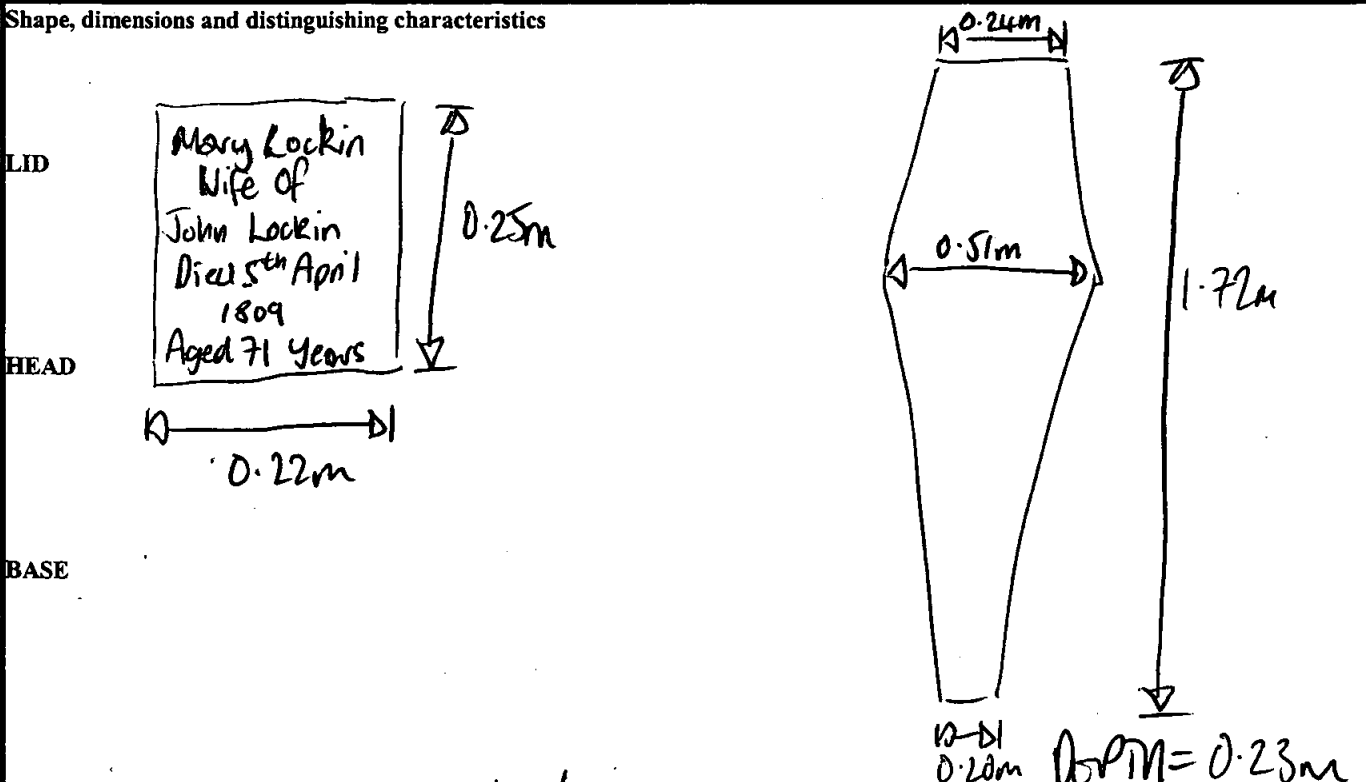

Recorder: <i>DBM</i>	Date: <i>03/11/00</i>	Initials:
----------------------	-----------------------	-----------

860

OLR00

~~Cherub~~ 2 grips

Material: Fe

Type: "Cherub" (double)

Spitalfields 4 ~~8~~ letter I do not know.



db

SITE a100	COFFIN RECORD SHEET	CONTEXT NO. 861
Trench:	Additional sheets: YES X1	Treatment:
Site sub-div: SC	Grave fills	DNA / BONE COLLECTED
Plan no: 6	Grave cut:	Finds None
Section no:	Skeleton: GOOD/N.	Breastplate ✓ Grip ✓
Co-ordinates:	Matrix location (827) (861)	Hinge Bracket
Levels	Preservation: POOR	Fixing nails Shroud pins
Slide No.	Neg No:	Fabric Other finds

**Description** E-W ADULT BURIAL. Pk lined coffin, soldered top & base. "CAPT. Alex Francis Bailey R.N." (Royal Navy?) CROSS-MATCHING PRESENT ON COFFIN TOP. No evidence of shroud

**Discussion** ETC - Coffin very waterlogged in places - bone in around pelvic regions badly decayed.

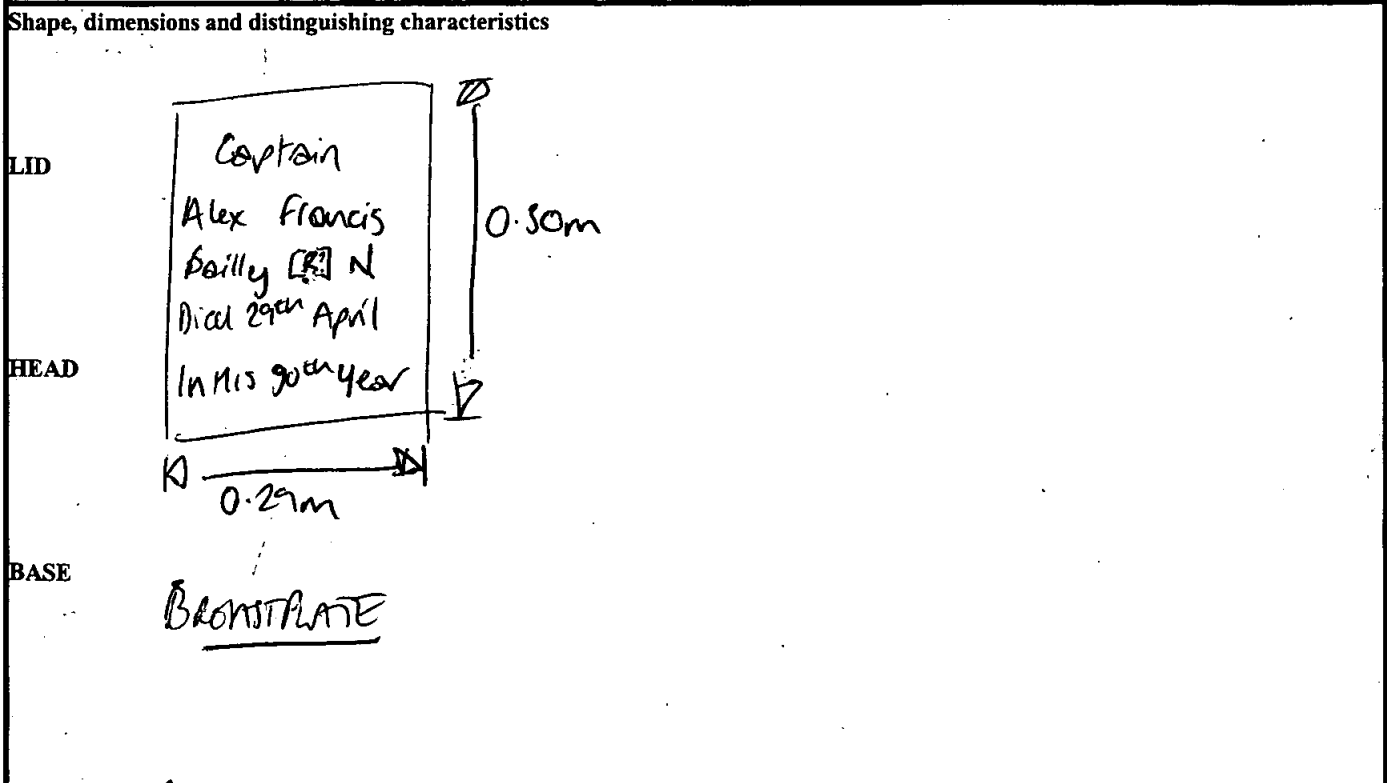

Recorder: <i>ABM</i>	Date: 01/11/00	Initials:
----------------------	----------------	-----------



SITE	COFFIN RECORD SHEET	CONTEXT NO.
04200		862
Trench:	Additional sheets:	Treatment:
Site sub-div: S.C.	Grave fills:	Bone/Ona covered
Plan no: 6	Grave cut:	Finds None <input checked="" type="checkbox"/>
Section no:	Skeleton: AXIAL ME - POOR ALAND FEMUR LEGAL.	Breastplate Grip <input checked="" type="checkbox"/>
Co-ordinates:	Matrix location: 861 862	Hinge Bracket
Levels	Preservation: Good	Fixing nails Shroud pins
Slide No.	Neg No:	Fabric Other finds

**Description**  
 E & W ADULT BURIAL. Pb LINER coffin, soldered ribs  
 BASE. SOLDERED I.P. PLATE TO BREAST OF COFFIN. DIRT WOOD  
 NOT VISIBLE. SHROUD REMAINS VISIBLE ON ENTIRE SURFACES.

**Discussion**

**Shape, dimensions and distinguishing characteristics**

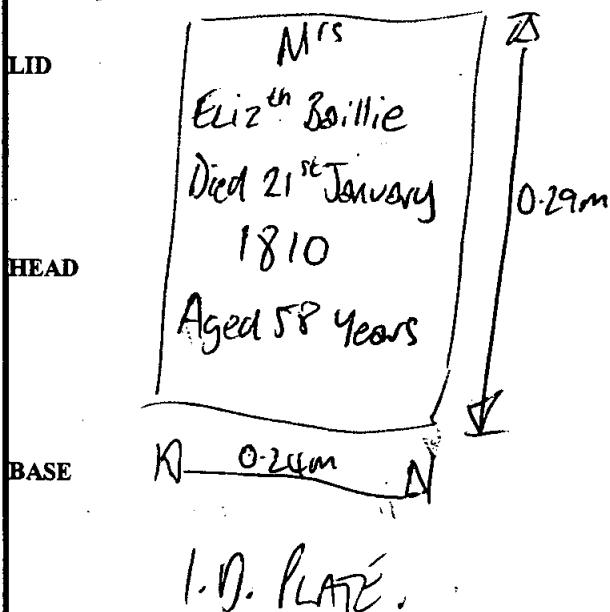

Recorder: <i>[Signature]</i>	Date: 01/11/00	Initials:
------------------------------	----------------	-----------

**Outer Coffin**

Sample Ret.

Site Code

Context

Recording Date ..... 20/2/01 .....

OLR00

862

Associated Numbers .....

Condition .....

Dep. Plate

Legible

Inscription

Fabric lead  ormolou  brass  tin plated pewter  gilt tin   
 iron  silvered tin  enamelled  other ..... Sample Ret.

**Shape of dep. plate**

square  rectangle  shield  tapered  lozenge   
 cartouche  oval  other .....

**Upholstery**

colour ..... shoddy  velvet  other ..... Sample Ret.

**Construction**

butt joint  mitred  pitched  other .....

**Grip plate**

*Fabric = ormolou*  brass  tin plated pewter  gilt tin   
*Feeds on rev of grip-wood*  
 iron  silvered tin  enamelled  other ..... Sample Ret.

**Grip**

*Fabric = ormolou*  brass  iron  Sample Ret.

**Design**

swag of rose  horseshoe  cherub's head  <sup>x 1</sup> ① plain

other .....

**Grip bolts**

**Corner bolts**  **Type =** gilt brass  brass  iron

other ..... Sample Ret.

**Lid motifs**

other ..... Sample Ret.

**Escutcheons**

other ..... Sample Ret.

**Upholstery** <sup>studs</sup> ~~nails~~

brass  gilt brass  silvered brass  iron  enamelled   
 other ..... 1 x 0000 = 5 studs ..... Sample Ret.

**Fixings**

panel nails  screws  hinges  lace  Sample Ret.

**Timber type** .....

Sample Ret.

**Interpretation / Comments**

.....  
 .....

SITE	COFFIN RECORD SHEET		CONTEXT NO.
OLR 00	Additional sheets:		863
Trench:	Grave fills	Treatment: B.C.	
Site sub-div: SC	Grave cut:	Finds	
Plan no: 6	Skeleton: 863	None	
Section no:	Matrix location: 863	Breastplate	
Co-ordinates:	864	Grip <input checked="" type="checkbox"/>	
Levels	Preservation: POOR.	Hinge	
Slide No.	Neg No:	Bracket	
Description		Fixing nails	
Discussion		Shroud pins	
Shape, dimensions and distinguishing characteristics		Fabric	
LID		Other finds	
HEAD			
BASE			
Recorder: D. Hall	Date: 4.11.00	Initials:	

E-W Adult burial lying on top of lead coffin 864. V. poorly preserved.

Discussion

Shape, dimensions and distinguishing characteristics

LID

HEAD

BASE

Recorder: D. Hall

Date: 4.11.00

Initials:

*db*

# Coffin Recording Sheet

Site Code

Context

OLR00

863

**Outer Coffin**

Sample Ret.

Recording Date ..... *14/12/00* .....

Associated Numbers .....

Condition .....

Dep. Plate

Legible

Inscription

Fabric lead       ormolou       brass       tin plated pewter       gilt tin   
 iron       silvered tin       enamelled       other .....      Sample Ret.

**Shape of dep. plate**

square       rectangle       shield       tapered       lozenge   
 cartouche       oval       other .....

**Upholstery**

colour .....      shoddy       velvet       other .....      Sample Ret.

**Construction**

butt joint       mitred       pitched       other .....

**Grip plate**

Fabric = ormolou       brass       tin plated pewter       gilt tin   
*Feeds on rev of grip-wood.*  
 iron       silvered tin       enamelled       other .....      Sample Ret.

**Grip**

Fabric = ormolou       brass       iron  x 2      Sample Ret.

**Design**

swag of rose       horseshoe       cherub's head       *(20)'s*      plain

other .....

**Grip bolts**

**Corner bolts**       Type =      gilt brass       brass       iron

other .....      Sample Ret.

**Lid motifs**

other .....

Sample Ret.

**Escutcheons**

other .....

Sample Ret.

**Upholstery nails**

brass       gilt brass       silvered brass       iron       enamelled

other .....      Sample Ret.

**Fixings**

panel nails       screws       hinges       lace       Sample Ret.

**Timber type**

.....      Sample Ret.

**Interpretation / Comments**

.....  
 .....

SITE <i>OLR 00</i>	COFFIN RECORD SHEET	CONTEXT NO. <i>864</i>
Trench:	Additional sheets:	Treatment: <i>B.C.</i>
Site sub-div: <i>SC</i>	Grave fills	
Plan no: <i>6</i>	Grave cut:	Finds None
Section no:	Skeleton: <i>864</i>	Breastplate <input checked="" type="checkbox"/> Grip
Co-ordinates:	Matrix location: <i>863</i> <i>864</i> <i>865</i>	Hinge Bracket
Levels	Preservation: <i>Fair - good.</i>	Fixing nails Shroud pins
Slide No.	Neg No:	Fabric Other finds
<p><b>Description</b> <i>E-W Adult in lead coffin, coffin crushed at sides due to weight above. <del>to</del> Some extant wood around sides, but too crushed to get true dimensions. Plate illegible ∴ no DNA taken.</i></p> <p><b>Discussion</b></p>		
<p><b>Shape, dimensions and distinguishing characteristics</b></p> <p>LID</p> <p>HEAD</p> <p>BASE</p>		
Recorder: <i>D. Ham</i>	Date: <i>4.11.00.</i>	Initials:

**Outer Coffin**

Sample Ret.

Site Code

Context

Recording Date ..... 20/2/01 .....

OLR00

864

Associated Numbers .....

Condition ..... 1 .....

Dep. Plate

Legible  15 ft

Inscription *Mrs/Eliz<sup>th</sup> Cro... /Died? 1<sup>th</sup> Feb/17? 9 1/2 hrs? 6 1/2" (9) w/out outer border.*

Fabric lead  ormolou  brass  tin plated pewter  gilt tin   
 iron  silvered tin  enamelled  other ..... Sample Ret.

**Shape of dep. plate**

square  rectangle  shield  tapered  lozenge   
 cartouche  oval  other .....

**Upholstery**

colour ..... shoddy  velvet  other ..... Sample Ret.

**Construction**

butt joint  mitred  pitched  other .....

**Grip plate**

Fabric = ormolou  brass  tin plated pewter  gilt tin   
 iron  silvered tin  enamelled  other ..... Sample Ret.

**Grip**

Fabric = ormolou  brass  iron  Sample Ret.

**Design**

swag of rose  horseshoe  cherub's head  plain

other .....

**Grip bolts**

Corner bolts  Type = gilt brass  brass  iron

other ..... Sample Ret.

**Lid motifs**

other ..... Sample Ret.

**Escutcheons**

other ..... Sample Ret.

**Upholstery nails**

brass  gilt brass  silvered brass  iron  enamelled   
 other ..... Sample Ret.

**Fixings**

panel nails  screws  hinges  lace  Sample Ret.

**Timber type** .....

Sample Ret.

**Interpretation / Comments**

.....  
 .....



SITE	COFFIN RECORD SHEET	CONTEXT NO.
OZR 50	Additional sheets:	865 Treatment: B.C.
Trench:	Grave fills	
Site sub-div: SC	Grave cut:	Finds
Plan no: 6	Skeleton: 865	None
Section no:	Matrix location: 864 865	Breastplate Grip ✓
Co-ordinates:	Preservation: FAIR.	Hinge
Levels	Neg No:	Bracket
Slide No.	Description	Fixing nails Shroud pins
E-W Adult burial, legs truncated by vault (126). Lost from <del>dist</del> proximal. Ribia down.		
Discussion		
Shape, dimensions and distinguishing characteristics		
LID		
HEAD		
BASE		
Recorder: D. Hall	Date: 4.11.50.	Initials:



SITE	COFFIN RECORD SHEET		CONTEXT NO.
OR 00	Additional sheets:	866 Treatment: B.C.	
Trench:	Grave fills		
Site sub-div: AEE SC	Grave cut:	Finds	
Plan no: 6	Skeleton: 866	None <input checked="" type="checkbox"/>	
Section no:	Matrix location: 864 865 866	Breastplate	
Co-ordinates:	Preservation: FAIR/GOOD.	Grip	
Levels	Neg No:	Hinge	
Slide No.	Discussion	Bracket	
Description <span style="border: 1px solid black; padding: 2px;">126</span> E-W Adult burial, lower legs + feet truncated by vault . wide cut + arms far apart - bones average size but perhaps a rather 'large' person?! Cut about 0.5m across.			
Shape, dimensions and distinguishing characteristics			
LID			
HEAD			
BASE			
Recorder: D. ARM	Date: 4.11.00	Initials:	

SITE	COFFIN RECORD SHEET	CONTEXT NO.
02R 00		867
Trench:	Additional sheets:	Treatment: B.C.
Site sub-div: <del>A</del> SC	Grave fills	
Plan no: 6	Grave cut:	Finds None
Section no:	Skeleton: 867	Breastplate Grip
Co-ordinates:	Matrix location: WITHIN VAULT T25	Hinge Bracket
Levels	Preservation: FAIR.	Fixing nails Shroud pins
Slide No.	Neg No:	Fabric Other finds
<p>Description: E-W Ad. M. head Coffin, wood lined, with no name plate. Retrieval of small bones fairly difficult due to this coffin having 3" of water in it.</p> <p>Discussion</p>		
<p>Shape, dimensions and distinguishing characteristics</p> <p>LID</p> <p>HEAD</p> <p>BASE</p>		
Recorder: J. Horn	Date: 4.11.00.	Initials:

SITE	COFFIN RECORD SHEET	CONTEXT NO.
OLR 00		868
Trench:	Additional sheets:	Treatment:
Site sub-div: S.C. VULT 124	Grave fills	bones / DNA covered
Plan no: 6	Grave cut:	Finds
Section no:	Skeleton: ABBAGE	None
Co-ordinates:	Matrix location: 868 WITHIN 124 870	Breastplate ✓ Grip ✓
Levels	Preservation: Poor	Hinge Bracket
Slide No.	Neg No:	Fixing nails Shroud pins
		Fabric Other finds

**Description** E-W ADULT BURIAL WITHIN VULT 124. Pb lined coffin narrow, bands soldered top & base. Breastplate pinned to outer wood coffin. Outer coffin decoration also present. Coffin

**Discussion** I.D. PLATE SOLDERED TO BREAST OF COFFIN. Coffin damaged by MACHINE. ∴ NO DIMENSIONS.

Shape, dimensions and distinguishing characteristics

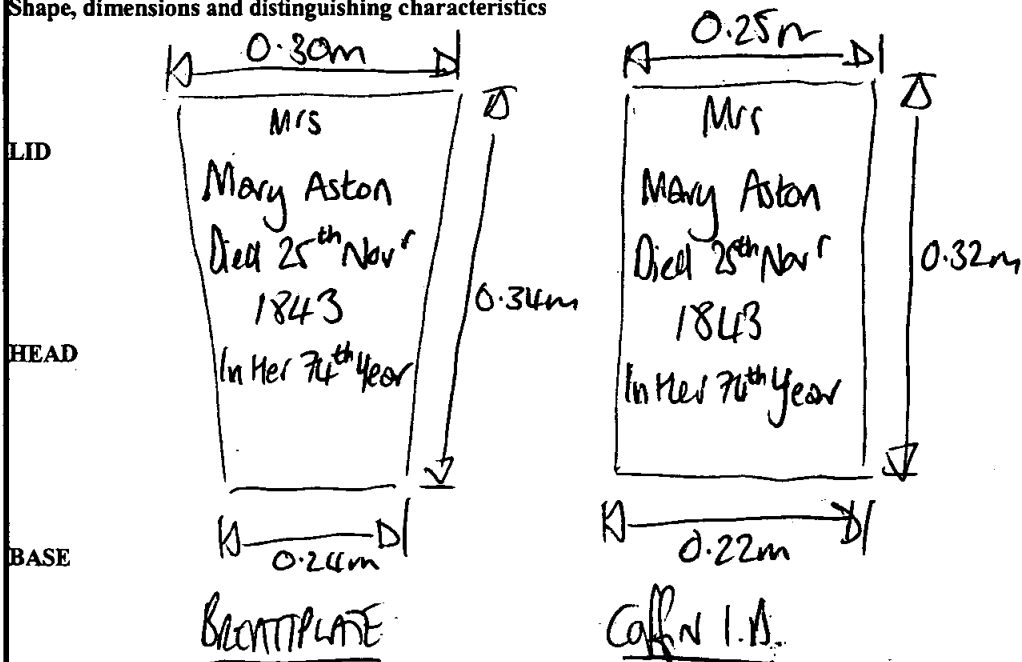

Recorder: <i>BM</i>	Date: 02/11/00	Initials:
---------------------	----------------	-----------

*clb.*

# Coffin Recording Sheet

Site Code

Context

**Outer Coffin**

Sample Ret.

02000

868

Recording Date ..... 15/11/00 .....

Associated Numbers .....

Condition ..... A .....

Dep. Plate

Legible

Inscription *umrs/mary Aston/died 28<sup>th</sup> Nov<sup>r</sup>/1841/In her 74<sup>th</sup> Year<sup>n</sup>*

Fabric lead  ormolou  brass  tin plated pewter  gilt tin   
 iron  silvered tin  enamelled  other ..... Sample Ret.

*to see version of 112, J. PRICE, LONDON  
 some 00  
 + 'Hollmark?'  
 SEE OVER  
 w/ diff lozenge  
 outer border.*

**Shape of dep. plate**

square  rectangle  shield  tapered   
 cartouche  oval  other ..... *0.285* *0.39* *0.23*

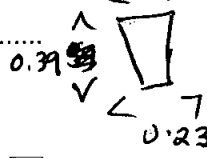

**Upholstery**

colour ..... shoddy  velvet  other ..... Sample Ret.

**Construction**

butt joint  mitred  pitched  other .....

**Grip plate**

Fabric = ormolou  brass  tin plated pewter  gilt tin

iron  silvered tin  enamelled  other ..... Sample Ret.

**Grip**

Fabric = ormolou  brass  iron  *x1* Sample Ret.

**Design**

swag of rose  horseshoe  cherub's head  plain

other ..... *too conc. to id.*

**Grip bolts**

Corner bolts  Type = gilt brass  brass  iron

other ..... Sample Ret.

**Lid motifs**

other *x1 ⊕ p.b. ↑ 0.22 ↔ 0.135* Sample Ret.

**Escutcheons**

other ..... Sample Ret.

**Upholstery nails**

brass  gilt brass  silvered brass  iron  enamelled

other ..... Sample Ret.

**Fixings**

panel nails  screws  hinges  lace  Sample Ret.

**Timber type** .....

Sample Ret.

**Interpretation / Comments**

.....  
 .....

detail of 'hallmark' (see 112 for full sketch)  
(bottom RHS.)

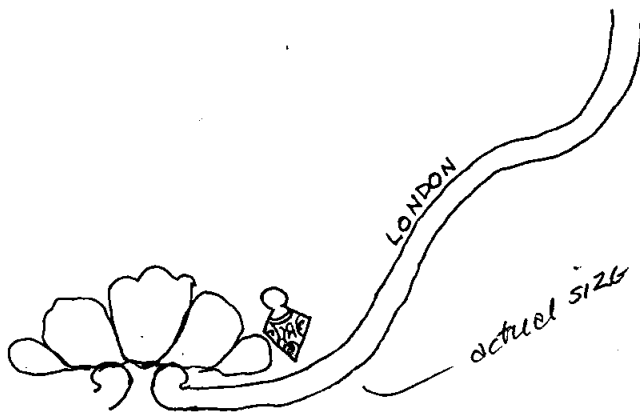

blow-up.

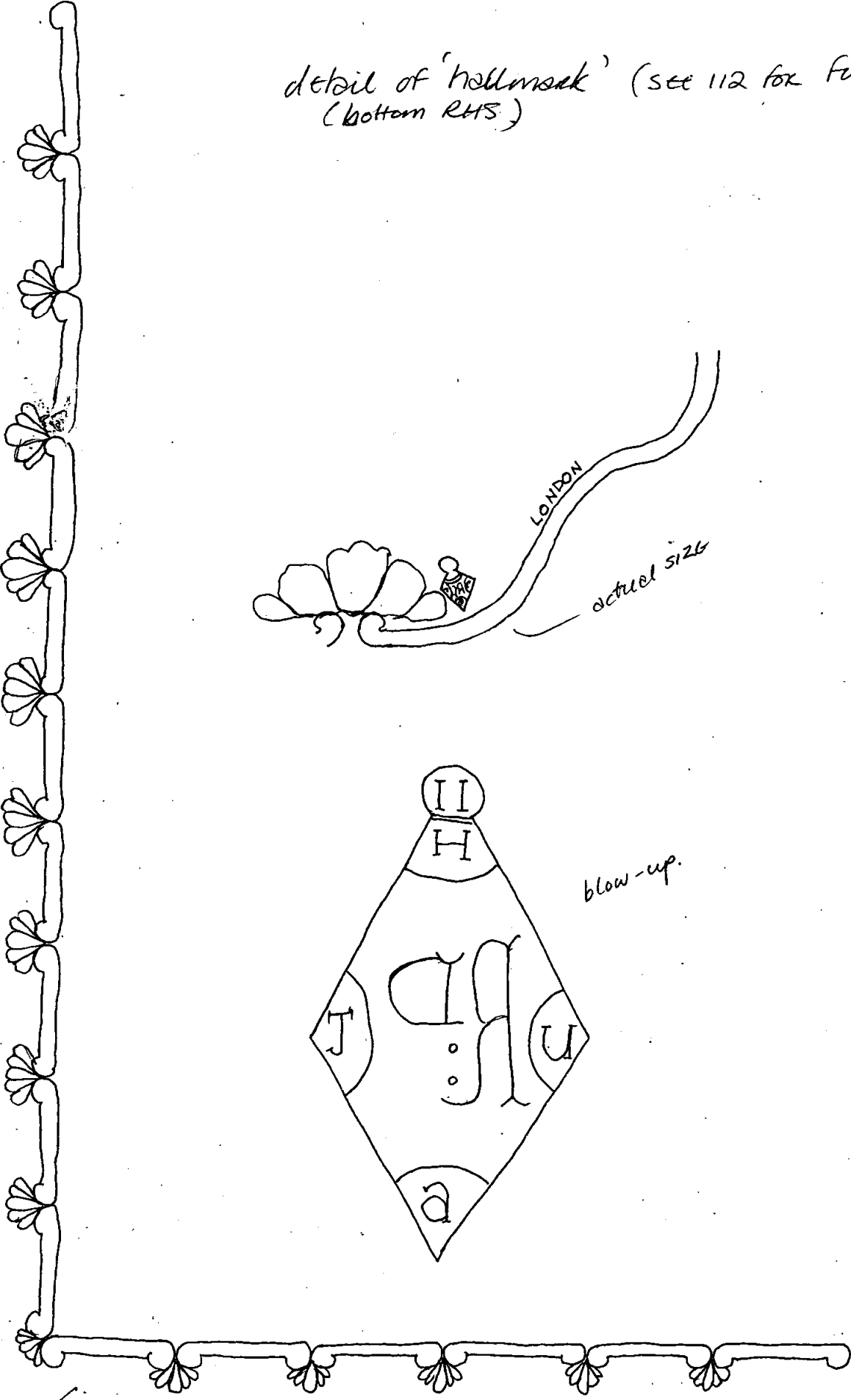
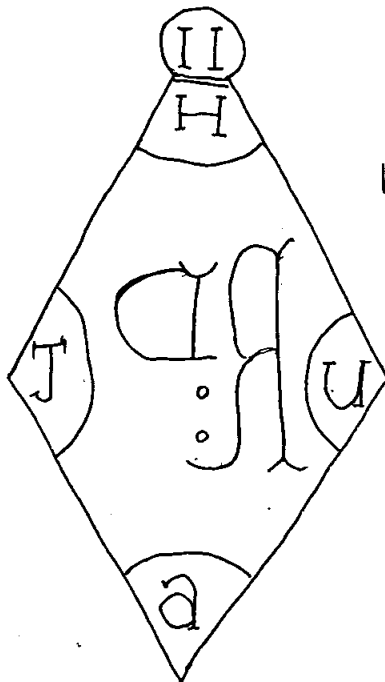

outer border.

SITE	COFFIN RECORD SHEET	CONTEXT NO.
02R00		869
Trench:	Additional sheets:	Treatment:
Site sub-div: S.C. VAULT 124	Grave fills	bones/DNA CONSERVED
Plan no: 6	Grave cut:	Finds
Section no:	Skeleton: GOOD	None
Co-ordinates:	Matrix location:	Breastplate <input checked="" type="checkbox"/>
Levels	Preservation: V. POOR	Grip
Slide No.	Neg No:	Hinge
		Bracket
		Fixing nails
		Shroud pins
		Fabric
		Other finds

**Description** E-W ADULT BURIAL WITHIN VAULT 124. PLUMBO COFFIN SCRIBED (NARROW SAND) TOP of FACE COFFIN DAMAGED BY MACHINE, <sup>ALSO SOME FINING EVIDENCE - REPAIR?</sup> NO DIMENSIONS. BREASTPLATE SHATTERED, COFFIN I.D.

**Discussion** SCRIBED TO 'FOOT' of COFFIN, NOT BREAST. COFFIN CRUSHED - POSS. AS A RESULT of VAULT COLLAPSE.

Shape, dimensions and distinguishing characteristics

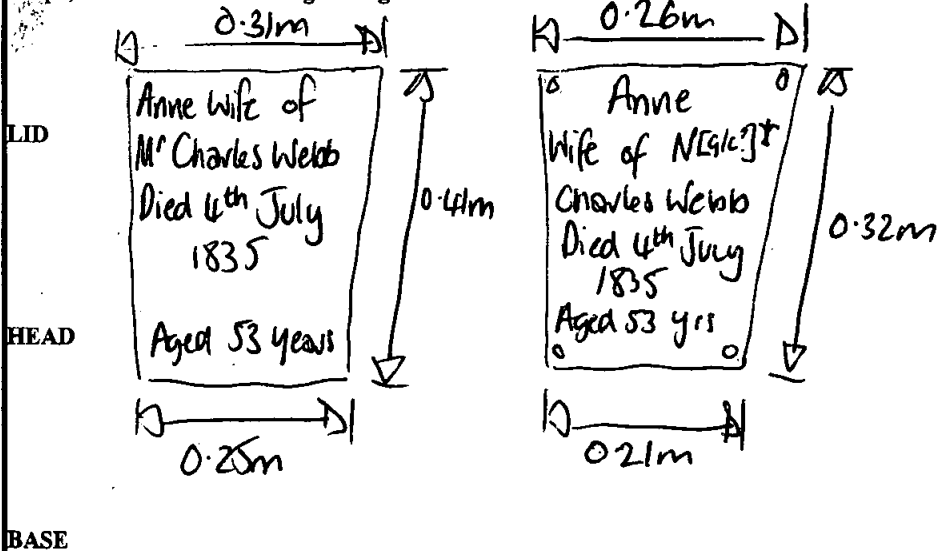

Recorder: <i>AM</i>	Date: 07/11/00	Initials:
---------------------	----------------	-----------



*db*

# Coffin Recording Sheet

Site Code

Context

**Outer Coffin**

Sample Ret.

**OLR00**

**869**

Recording Date *15/11/00*

Associated Numbers .....

Condition *1*

Dep. Plate

Legible  *NO*

*+ inscript. (plain tapered)*

Inscription

*"Ann/Wife of Mr/Charles Webb/ Died 4<sup>th</sup> July/1835/Aged 33 Yrs"*

Fabric lead  ormolou  brass  tin plated pewter  gilt tin   
 iron  silvered tin  enamelled  other ..... Sample Ret.

**Shape of dep. plate**

square  rectangle  shield  *(20)* tapered  lozenge   
 cartouche  oval  other .....

**Upholstery**

colour ..... shoddy  velvet  other ..... Sample Ret.

**Construction**

butt joint  mitred  pitched  other .....

**Grip plate**

Fabric = ormolou  brass  tin plated pewter  gilt tin   
 iron  silvered tin  enamelled  other ..... Sample Ret.

**Grip**

Fabric = ormolou  brass  iron  Sample Ret.

**Design**

swag of rose  horseshoe  cherub's head  plain

other .....

**Grip bolts**

Corner bolts  Type = gilt brass  brass  iron

other ..... Sample Ret.

**Lid motifs**

other .....

Sample Ret.

**Escutcheons**

other .....

Sample Ret.

**Upholstery nails**

brass  gilt brass  silvered brass  iron  enamelled

other ..... Sample Ret.

**Fixings**

panel nails  screws  hinges  lace  Sample Ret.

**Timber type** .....

Sample Ret.

**Interpretation / Comments**

.....  
 .....

SITE		COFFIN RECORD SHEET		CONTEXT NO.	
02200				870	
Trench:		Additional sheets:		Treatment:	
Site sub-div: S.C. VAULT 124		Grave fills		BONES COLLECTED	
Plan no: 6		Grave cut:		Finds None <input checked="" type="checkbox"/>	
Section no:		Skeleton: Av.		Breastplate Grip	
Co-ordinates:		Matrix location: 868 870 VAULT 124		Hinge Bracket	
Levels		Preservation: Poor		Fixing nails Shroud pins	
Slide No.		Neg No:		Fabric Other finds	
<p>Description: E-W ADULT BURIAL - Pb LINED COFFIN, SAVED BY BASE. NO DIMENSIONS DUE TO DIST. BY MACHINE. NO I.D.</p> <p>Discussion:</p>					
<p>Shape, dimensions and distinguishing characteristics</p> <p>LID</p> <p>NO NAME</p> <p>HEAD</p> <p>BASE</p>					
Recorder: [Signature]		Date: 07/1/00		Initials:	

# Coffin Recording Sheet

**Outer Coffin**

Sample Ret.

Site Code

Context

Recording Date ..... 16/2/01

0200

870

Associated Numbers .....

Condition .....

Dep. Plate

Legible

Inscription

**Fabric** lead  ormolou  brass  tin plated pewter  gilt tin   
 iron  silvered tin  enamelled  other ..... Sample Ret.

**Shape of dep. plate**

square  rectangle  shield  tapered  lozenge   
 cartouche  oval  other .....

**Upholstery**

colour ..... shoddy  velvet  other ..... Sample Ret.

**Construction**

butt joint  mitred  pitched  other .....

**Grip plate**  **Fabric =** ormolou  brass  tin plated pewter  gilt tin   
 iron  silvered tin  enamelled  other ..... Sample Ret.

**Grip**  **Fabric =** ormolou  brass  iron  <sup>x1</sup> Sample Ret.

**Design** swag of rose  horseshoe  cherub's head  <sup>(6)</sup> plain   
 other .....

**Grip bolts**  **Corner bolts**  **Type =** gilt brass  brass  iron   
 other ..... Sample Ret.

**Lid motifs**  other ..... Sample Ret.

**Escutcheons**  other ..... Sample Ret.

**Upholstery nails**  brass  gilt brass  silvered brass  iron  enamelled   
 other ..... Sample Ret.

**Fixings**  panel nails  screws  hinges  lace  Sample Ret.

**Timber type** ..... Sample Ret.

**Interpretation / Comments**

.....  
 .....

SITE	COFFIN RECORD SHEET	CONTEXT NO.
02R 50		871
Trench:	Additional sheets:	Treatment: B.C.
Site sub-div: SC	Grave fills	
Plan no: 6	Grave cut:	Finds
		None
Section no:	Skeleton: 871	Breastplate <input checked="" type="checkbox"/>
		Grip
Co-ordinates:	Matrix location: 871 872	Hinge
		Bracket
Levels	Preservation: Fair.	Fixing nails
		Shroud pins
Slide No.	Neg No:	Fabric
		Other finds
<b>Description</b> E-W Adult burial, overlying 872, fair condition. Nameplate disintegrated.		
<b>Discussion</b>		
<b>Shape, dimensions and distinguishing characteristics</b>		
<b>LID</b>		
<b>HEAD</b>		
<b>BASE</b>		
Recorder: D Ham	Date: 7.11.00	Initials:

*db*

# Coffin Recording Sheet

Site Code

Context

**Outer Coffin**

Sample Ret.

*ONR00*

*871*

Recording Date ..... *12/12/00* .....

Associated Numbers .....

Condition ..... *1* .....

Dep. Plate

Legible  *NO*

Inscription

Fabric lead  ormolou  brass  tin plated pewter  gilt tin   
 iron  silvered tin  enamelled  other ..... Sample Ret.

*same as 1152*

**Shape of dep. plate**

square  rectangle  shield  tapered  lozenge   
 cartouche  oval  other .....

**Upholstery**

colour ..... shoddy  velvet  other ..... Sample Ret.

**Construction**

butt joint  mitred  pitched  other .....

**Grip plate**

Fabric = ormolou  brass  tin plated pewter  gilt tin   
 iron  silvered tin  enamelled  other ..... Sample Ret.

**Grip**

Fabric = ormolou  brass  iron  *x3* Sample Ret.

**Design**

swag of rose  horseshoe  cherub's head  *conc. 4's.* plain   
 other .....

**Grip bolts**

Corner bolts  Type = gilt brass  brass  iron   
 other ..... Sample Ret.

**Lid motifs**

other ..... Sample Ret.

**Escutcheons**

other ..... Sample Ret.

**Upholstery nails**

brass  gilt brass  silvered brass  iron  enamelled   
 other ..... Sample Ret.

**Fixings**

panel nails  screws  hinges  lace  Sample Ret.

**Timber type** .....

Sample Ret.

*+ alloy ring - brass seeing?*  
 Interpretation / Comments

SITE <i>OR 00</i>		COFFIN RECORD SHEET	CONTEXT NO. <i>872</i>
Trench:	Additional sheets:	Treatment: <i>B.C.</i>	
Site sub-div: <i>SC</i>	Grave fills		
Plan no: <i>6</i>	Grave cut:	Finds None <input checked="" type="checkbox"/>	
Section no:	Skeleton: <i>872</i>	Breastplate Grip	
Co-ordinates:	Matrix location: <i>871</i> <i>872</i> <i>Truncated by 871</i>	Hinge Bracket	
Levels	Preservation: <i>v. poor.</i>	Fixing nails Shroud pins	
Slide No.	Neg No:	Fabric Other finds	
<b>Description</b> <i>E-W Adult burial, directly underneath 871, v. poorly preserved. Truncated from pelvic area to head by 872.</i>			
<b>Discussion</b>			
<b>Shape, dimensions and distinguishing characteristics</b>			
<b>LID</b>			
<b>HEAD</b>			
<b>BASE</b>			
Recorder: <i>D. Ham</i>	Date: <i>7.11.00.</i>	Initials:	

db.

SITE		COFFIN RECORD SHEET		CONTEXT NO.	
OUR 00				873	
Trench:		Additional sheets: <i>yes x1.</i>		Treatment:	
Site sub-div: <i>S.C.</i>		Grave fills		<i>Bone covered</i>	
Plan no: <i>6</i>		Grave cut:		Finds None <input checked="" type="checkbox"/>	
Section no:		Skeleton: <i>Good</i>		Breastplate Grip	
Co-ordinates:		Matrix location:		Hinge Bracket	
Levels		Preservation:		Fixing nails Shroud pins	
Slide No.		Neg No:		Fabric Other finds	
Description <i>E-W ADULT BURIAL. WOODEN COFFIN</i>					
Discussion					
Shape, dimensions and distinguishing characteristics					
LID					
HEAD					
BASE					
Recorder: <i>AM</i>		Date: <i>07/11/00</i>		Initials:	

# Coffin Recording Sheet

Site Code

Context

**Outer Coffin**

Sample Ret.

OLR00

873

Recording Date ..... 18/12/00 .....

Associated Numbers .....

Condition .....

Dep. Plate

Legible

Inscription

Fabric lead  ormolou  brass  tin plated pewter  gilt tin   
iron  silvered tin  enamelled  other ..... Sample Ret.

**Shape of dep. plate**

square  rectangle  shield  tapered  lozenge   
cartouche  oval  other .....

**Upholstery**

colour ..... shoddy  velvet  other ..... Sample Ret.

**Construction**

butt joint  mitred  pitched  other .....

**Grip plate**

Fabric = ormolou  brass  tin plated pewter  gilt tin   
iron  silvered tin  enamelled  other ..... Sample Ret.   
*Frag on rev of grip.*

**Grip**

Fabric = ormolou  brass  iron  XI. Sample Ret.

**Design**

swag of rose  horseshoe  cherub's head  plain   $\oplus$

other .....

**Grip bolts**

**Corner bolts**  Type = gilt brass  brass  iron

other ..... Sample Ret.

**Lid motifs**

other ..... Sample Ret.

**Escutcheons**

other ..... Sample Ret.

**Upholstery nails**

brass  gilt brass  silvered brass  iron  enamelled

other ..... Sample Ret.

**Fixings**

panel nails  screws  hinges  lace  Sample Ret.

**Timber type**

..... Sample Ret.

**Interpretation / Comments**

.....  
.....



SITE <u>Old 00</u>		COFFIN RECORD SHEET	CONTEXT NO. <u>874</u>
Trench:	Additional sheets:	Treatment:	
Site sub-div: <u>S.C.</u>	Grave fills	<u>Bands covered</u>	
Plan no: <u>6</u>	Grave cut:	Finds	
Section no:	Skeleton: <u>SP01</u>	None <input checked="" type="checkbox"/>	
Co-ordinates:	Matrix location: <u>874</u> <u>875</u>	Breastplate	
Levels	Preservation:	Grip <input checked="" type="checkbox"/>	
Slide No.	Neg No:	Hinge	
		Bracket	
		Fixing nails	
		Shroud pins	
		Fabric	
		Other finds	

Description E-W INFANT BURIAL, OVERLAYING 875. WOODEN COFFIN (NOT PRESENT)

Discussion

Shape, dimensions and distinguishing characteristics

LID

HEAD

BASE

Recorder: <u>DM</u>	Date: <u>08/11/00</u>	Initials:
---------------------	-----------------------	-----------

# Coffin Recording Sheet

**Outer Coffin**

Sample Ret.

Site Code

Context

Recording Date ..... 21/2/01 .....

Oh100

874

Associated Numbers .....

Condition .....

Dep. Plate

Legible

Inscription

Fabric lead  ormolou  brass  tin plated pewter  gilt tin   
 iron  silvered tin  enamelled  other ..... Sample Ret.

**Shape of dep. plate**

square  rectangle  shield  tapered  lozenge   
 cartouche  oval  other .....

**Upholstery**

colour ..... shoddy  velvet  other ..... Sample Ret.

**Construction**

butt joint  mitred  pitched  other .....

Grip plate  Fabric = ormolou  brass  tin plated pewter  gilt tin   
 iron  *Frog on rev. of grip-wood* silvered tin  enamelled  other ..... Sample Ret.

Grip  Fabric = ormolou  brass  iron  *2x* Sample Ret.

Design swag of rose  horseshoe  cherub's head  *infant* plain   
 other ..... *← 0.095* *↓ 0.05*

Grip bolts  Corner bolts  Type = gilt brass  brass  iron   
 other ..... Sample Ret.

Lid motifs  other ..... Sample Ret.

Escutcheons  other ..... Sample Ret.

Upholstery *studs*  brass  gilt brass  silvered brass  iron  enamelled   
 other ..... *2 pieces small studs / 1x000000 / 1x00000000 = 14 studs* Sample Ret.

Fixings  panel nails  screws  hinges  lace  Sample Ret.

Timber type ..... Sample Ret.

**Interpretation / Comments**

.....  
 .....

SITE <u>OLR00</u>		COFFIN RECORD SHEET	CONTEXT NO. <u>875</u>
Trench:	Additional sheets: <u>YES x 1</u>	Treatment:	
Site sub-div: <u>S.C.</u>	Grave fills	<u>Bones Collected</u>	
Plan no: <u>6</u>	Grave cut:	Finds None <input checked="" type="checkbox"/>	
Section no:	Skeleton: <u>Good</u>	Breastplate Grip <input checked="" type="checkbox"/>	
Co-ordinates:	Matrix location: <u>(874)</u> <u>(875)</u>	Hinge Bracket	
Levels	Preservation:	Fixing nails Shroud pins	
Slide No.	Neg No:	Fabric Other finds	
Description <u>E-ADW ADULT BURIAL. WOODEN COFFIN, GRIPS PRESENT.</u>			
Discussion			
Shape, dimensions and distinguishing characteristics			
LID			
HEAD			
BASE			
Recorder: <u>[Signature]</u>	Date: <u>08/11/00</u>	Initials:	

# Coffin Recording Sheet

Site Code

Context

**Outer Coffin**

Sample Ret.

OR200

875

Recording Date ..... 12/2/01 .....

Associated Numbers .....

Condition .....

Dep. Plate

Legible

Inscription

Fabric lead  ormolou  brass  tin plated pewter  gilt tin   
 iron  silvered tin  enamelled  other ..... Sample Ret.

**Shape of dep. plate**

square  rectangle  shield  tapered  lozenge   
 cartouche  oval  other .....

**Upholstery**

colour ..... shoddy  velvet  other ..... Sample Ret.

**Construction**

butt joint  mitred  pitched  other .....

**Grip plate**  Fabric = ormolou  brass  tin plated pewter  gilt tin   
 iron  silvered tin  enamelled  other ..... Sample Ret.

**Grip**  Fabric = ormolou  brass  iron  Sample Ret.

**Design** swag of rose  horseshoe  cherub's head  (5) plain   
 other .....

**Grip bolts**  **Corner bolts**  **Type =** gilt brass  brass  iron   
 other ..... Sample Ret.

**Lid motifs**  other ..... Sample Ret.

**Escutcheons**  other ..... Sample Ret.

**Upholstery nails**  brass  gilt brass  silvered brass  iron  enamelled   
 other ..... Sample Ret.

**Fixings**  panel nails  screws  hinges  lace  Sample Ret.

**Timber type** ..... Sample Ret.

**Interpretation / Comments**

.....  
 .....

SITE <u>OLR00</u>		COFFIN RECORD SHEET	CONTEXT NO. <u>876</u>
Trench:	Additional sheets: <u>168 x 1</u>	Treatment:	
Site sub-div: <u>S.C.</u>	Grave fills	<u>Down covered</u>	
Plan no: <u>6</u>	Grave cut:	Finds None <input checked="" type="checkbox"/>	
Section no:	Skeleton: <u>SOOP - FANTASTIC CONDITION.</u>	Breastplate Grip <input checked="" type="checkbox"/>	
Co-ordinates:	Matrix location:	Hinge Bracket	
Levels	Preservation:	Fixing nails Shroud pins	
Slide No.	Neg No:	Fabric Other finds	
Description <u>EDW ADULT BURIAL. WOODEN COFFIN. POSS. OSSIFIED TUMOUR? WITHIN PELVIC REGION.</u>			
Discussion			
Shape, dimensions and distinguishing characteristics			
LID			
HEAD			
BASE			
Recorder: <u>[Signature]</u>	Date: <u>08/11/00</u>	Initials:	

Site Code

Context

**Outer Coffin**

Sample Ret.

02100

876

Recording Date ..... 13/2/01 .....

Associated Numbers .....

Condition .....

Dep. Plate

Legible

Inscription

Fabric lead  ormolou  brass  tin plated pewter  gilt tin   
 iron  silvered tin  enamelled  other ..... Sample Ret.

**Shape of dep. plate**

square  rectangle  shield  tapered  lozenge   
 cartouche  oval  other .....

**Upholstery**

colour ..... shoddy  velvet  other *nessian backed onto g. plate between fellows wood.* Sample Ret.

**Construction**

butt joint  mitred  pitched  other .....

**Grip plate**

Fabric = ormolou  brass  tin plated pewter  gilt tin   
 iron  *resps - unid* silvered tin  enamelled  *Black* other ..... Sample Ret.

**Grip**

Fabric = ormolou  brass  iron  *x2 (20's)* Sample Ret.

**Design**

swag of rose  horseshoe  cherub's head  plain   
 other .....

**Grip bolts**

Corner bolts  Type = gilt brass  brass  iron

other ..... Sample Ret.

**Lid motifs**

other ..... Sample Ret.

**Escutcheons**

other ..... Sample Ret.

**Upholstery** *studs*

brass  gilt brass  silvered brass  iron  enamelled

other ..... *2 x singlos.* Sample Ret.

**Fixings**

panel nails  screws  hinges  lace  Sample Ret.

**Timber type** .....

Sample Ret.

**Interpretation / Comments**

.....  
 .....

SITE <u>OLH00</u>		COFFIN RECORD SHEET	CONTEXT NO. <u>877</u>
Trench:	Additional sheets:	Treatment:	
Site sub-div: <u>S.C.</u>	Grave fills:	<u>None</u>	
Plan no: <u>6</u>	Grave cut:	Finds	
Section no:	Skeleton: <u>Good</u>	None	
Co-ordinates:	Matrix location: <u>with 1306</u>	Breastplate	
Levels	Preservation:	Grip	
Slide No.	Neg No:	Hinge	
Description <u>EDW ADULT SKELETON - REMOVED BY MACHINE DUE TO EXC. NORTH - PROB. 3 BURIALS.</u>		Bracket	
Discussion		Fixing nails	
Shape, dimensions and distinguishing characteristics		Shroud pins	
LID		Fabric	
HEAD		Other finds	
BASE			
Recorder: <u>DM/DH</u>	Date: <u>08/11/00</u>	Initials:	

SITE	COFFIN RECORD SHEET		CONTEXT NO.
OLR00	Additional sheets:	878	
Trench:	Grave fills	Treatment: Bones covered	
Site sub-div: S.C.	Grave cut:	Finds None ✓	
Plan no: 6	Skeleton: Good	Breastplate Grip	
Section no:	Matrix location: 878 879	Hinge Bracket	
Co-ordinates:	Preservation:	Fixing nails Shroud pins	
Levels	Neg No:	Fabric Other finds	
Slide No.	Description		
E-W ADULT BURIAL. WOODEN COFFIN			
Discussion			
Shape, dimensions and distinguishing characteristics			
LID			
HEAD			
BASE			
Recorder: DM/DM	Date: 08/11/00	Initials:	



Site Code

Context

OHROO

878

**Outer Coffin**

Sample Ret.

Recording Date ..... 16/2/01 .....

Associated Numbers .....

Condition .....

Dep. Plate

Legible

Inscription

Fabric lead  ormolou  brass  tin plated pewter  gilt tin   
 iron  silvered tin  enamelled  other ..... Sample Ret.

**Shape of dep. plate**

square  rectangle  shield  tapered  lozenge   
 cartouche  oval  other .....

**Upholstery**

colour ..... shoddy  velvet  other ..... Sample Ret.

**Construction**

butt joint  mitred  pitched  other .....

**Grip plate**

*Fabric = ormolou*  brass  tin plated pewter  gilt tin   
*Feags on rev of grip & unid.*  
 iron  silvered tin  enamelled  other ..... Sample Ret.

**Grip**

*Fabric = ormolou*  brass  iron  <sup>x 3</sup> <sub>(4) /s</sub> Sample Ret.

**Design**

swag of rose  horseshoe  cherub's head  plain

other .....

**Grip bolts**

**Corner bolts**  Type = gilt brass  brass  iron

other ..... Sample Ret.

**Lid motifs**

other ..... Sample Ret.

**Escutcheons**

other ..... Sample Ret.

**Upholstery nails**

brass  gilt brass  silvered brass  iron  enamelled

other ..... Sample Ret.

**Fixings**

panel nails  screws  hinges  lace  Sample Ret.

**Timber type** .....

Sample Ret.

**Interpretation / Comments**

.....  
 .....

SITE	COFFIN RECORD SHEET	CONTEXT NO.
OUR 00	Additional sheets: 4/28 x 1	879
Trench:	Grave fills	Treatment: BONE COLLECTED
Site sub-div: S.C.	Grave cut:	Finds
Plan no: 6	Skeleton:	None <input checked="" type="checkbox"/>
Section no:	Matrix location: 878 1 879	Breastplate Grip
Co-ordinates:	Preservation:	Hinge Bracket
Levels	Neg No:	Fixing nails Shroud pins
Slide No.	Description	Fabric Other finds
<p>EA W ADULT BURIAL, WOODEN COFFIN</p> <p>Discussion</p>		
<p>Shape, dimensions and distinguishing characteristics</p> <p>LID</p> <p>HEAD</p> <p>BASE</p>		
Recorder: [Signature]	Date: 05/11/00	Initials:

# Coffin Recording Sheet

Site Code

Context

**Outer Coffin**

Sample Ret.

OR200

879

Recording Date ..... 13/01/00 .....

Associated Numbers .....

Condition .....

Dep. Plate

Legible

Inscription

Fabric lead  ormolou  brass  tin plated pewter  gilt tin   
 iron  silvered tin  enamelled  other ..... Sample Ret.

**Shape of dep. plate**

square  rectangle  shield  tapered  lozenge   
 cartouche  oval  other .....

**Upholstery**

colour ..... shoddy  velvet  other ..... Sample Ret.

**Construction**

butt joint  mitred  pitched  other .....

Grip plate  Fabric = ormolou  brass  tin plated pewter  gilt tin   
 iron  silvered tin  enamelled  other ..... Sample Ret.

Grip  Fabric = ormolou  brass  iron  <sup>x3</sup> Sample Ret.

Design swag of rose  horseshoe  cherub's head  <sup>5's</sup> plain   
 other .....

Grip bolts  Corner bolts  Type = gilt brass  brass  iron   
 other ..... Sample Ret.

Lid motifs  other ..... Sample Ret.

Escutcheons  other ..... Sample Ret.

Upholstery nails  brass  gilt brass  silvered brass  iron  enamelled   
 other ..... Sample Ret.

Fixings  panel nails  screws  hinges  lace  Sample Ret.

Timber type ..... Sample Ret.

**Interpretation / Comments**

.....  
 .....

SITE		COFFIN RECORD SHEET		CONTEXT NO.	
OUR 00				880	
Trench:		Additional sheets:		Treatment:	
Site sub-div: S.C.		Grave fills		Bone covered	
Plan no: 6		Grave cut:		Finds	
Section no:		Skeleton: 102 - INCOMPLETE		None	
Co-ordinates:		Matrix location: 880 881		Breastplate	
Levels		Preservation:		Grip	
Slide No.		Neg No:		Hinge	
				Bracket	
				Fixing nails	
				Shroud pins	
				Fabric	
				Other finds	
Description: E-W ADULT BURIAL, TRUNCATED BY 124					
Discussion					
Shape, dimensions and distinguishing characteristics					
LID					
HEAD					
BASE					
Recorder: AM An		Date: 08/11/00		Initials:	

**Outer Coffin**

Sample Ret.

Site Code

Context

Recording Date ..... 22/2/01.

Oh200

880

Associated Numbers .....

Condition .....

Dep. Plate

Legible

Inscription

**Fabric lead**  ormolou  brass  tin plated pewter  gilt tin   
 iron  silvered tin  enamelled  other ..... Sample Ret.

**Shape of dep. plate**

square  rectangle  shield  tapered  lozenge   
 cartouche  oval  other .....

**Upholstery**

colour ..... shoddy  velvet  other ..... Sample Ret.

**Construction**

butt joint  mitred  pitched  other .....

**Grip plate**  **Fabric =** ormolou  brass  tin plated pewter  gilt tin   
 iron  silvered tin  enamelled  other ..... Sample Ret.

**Grip**  **Fabric =** ormolou  brass  iron  <sup>x 1</sup> <sub>(4)</sub> Sample Ret.

**Design** swag of rose  horseshoe  cherub's head  plain   
 other .....

**Grip bolts**  **Corner bolts**  **Type =** gilt brass  brass  iron   
 other ..... Sample Ret.

**Lid motifs**  other ..... Sample Ret.

**Escutcheons**  other ..... Sample Ret.

**Upholstery nails**  brass  gilt brass  silvered brass  iron  enamelled   
 other ..... Sample Ret.

**Fixings**  panel nails  screws  hinges  lace  Sample Ret.

**Timber type** ..... Sample Ret.

**Interpretation / Comments**

.....  
 .....

SITE		COFFIN RECORD SHEET		CONTEXT NO.	
QBR 00				881	
Trench:		Additional sheets:		Treatment:	
Site sub-div: S.C.		Grave fills		B.C.	
Plan no: 6		Grave cut:		Finds	
Section no:		Skeleton: 100L		None <input checked="" type="checkbox"/>	
Co-ordinates:		Matrix location:		Breastplate	
Levels		Preservation:		Grip	
Slide No.		Neg No:		Hinge	
Description		810 881 882		Bracket	
Discussion				Fixing nails	
Shape, dimensions and distinguishing characteristics				Shroud pins	
LID				Fabric	
HEAD				Other finds	
BASE					
Recorder: DM DN		Date: 08/11/00		Initials:	

E-W INFANT BURIAL, TRUNCATED BY 124

SITE <u>OLR00</u>		COFFIN RECORD SHEET	CONTEXT NO. <u>802</u>
Trench:	Additional sheets:	Treatment:	
Site sub-div: <u>S.C.</u>	Grave fills	<u>B.C.</u>	
Plan no: <u>6</u>	Grave cut:	Finds	
Section no:	Skeleton: <u>found</u>	None	
Co-ordinates:	Matrix location: <u>801</u> <u>802</u> <u>803</u>	Breastplate	
Levels	Preservation:	Grip	
Slide No.	Neg No:	Hinge	
Description		Bracket	
<u>E-W ADULT BURIAL, TRUNCATED BY <span style="border: 1px solid black; padding: 2px;">124</span></u>		Fixing nails	
Discussion		Shroud pins	
Shape, dimensions and distinguishing characteristics		Fabric	
LID		Other finds	
HEAD			
BASE			
Recorder: <u>DM/DM</u>	Date: <u>02/11/00</u>	Initials:	

**Outer Coffin**

Sample Ret.

Site Code

Context

Recording Date ..... *22/2/01* .....

*Ohloo*

*882*

Associated Numbers .....

Condition .....

Dep. Plate

Legible

Inscription

Fabric lead  ormolou  brass  tin plated pewter  gilt tin   
 iron  silvered tin  enamelled  other ..... Sample Ret.

**Shape of dep. plate**

square  rectangle  shield  tapered  lozenge   
 cartouche  oval  other .....

**Upholstery**

colour ..... shoddy  velvet  other *buize* ..... Sample Ret.

**Construction** butt joint  mitred  pitched  other .....

**Grip plate**  Fabric = ormolou  brass  tin plated pewter  gilt tin   
*knop on rev of grip-wood*  
 iron  silvered tin  enamelled  other ..... Sample Ret.

**Grip**  Fabric = ormolou  brass  iron  *x1* Sample Ret.

**Design** swag of rose  horseshoe  cherub's head  *(20)* plain   
 other .....

**Grip bolts**  **Corner bolts**  **Type =** gilt brass  brass  iron

other ..... Sample Ret.

**Lid motifs**  other ..... Sample Ret.

**Escutcheons**  other ..... Sample Ret.

**Upholstery** *studs*  brass  gilt brass  silvered brass  iron  enamelled   
*1 x pieces*  
 other ..... *= 22 studs on knot of wood c. 4 cm thick* Sample Ret.

**Fixings**  panel nails  screws  hinges  lace  Sample Ret.

**Timber type** ..... Sample Ret.

**Interpretation / Comments**

.....  
 .....



SITE <b>AL00</b>	COFFIN RECORD SHEET	CONTEXT NO. <b>803</b>
Trench:	Additional sheets:	Treatment:
Site sub-div: <b>S.C.</b>	Grave fills	<b>B.C.</b>
Plan no: <b>6</b>	Grave cut:	Finds
Section no:	Skeleton: <b>four</b>	None <input checked="" type="checkbox"/>
Co-ordinates:	Matrix location: <b>802</b> <b>803</b>	Breastplate
Levels	Preservation:	Grip
Slide No.	Neg No:	Hinge
		Bracket
		Fixing nails
		Shroud pins
		Fabric
		Other finds

**Description**  
**E-W ADULT BURIAL, TRUNCATED BY 124**

**Discussion**

**Shape, dimensions and distinguishing characteristics**

**LID**

**HEAD**

**BASE**

Recorder: <b>DM/BN</b>	Date: <b>07/11/00</b>	Initials:
------------------------	-----------------------	-----------

SITE	COFFIN RECORD SHEET	CONTEXT NO.
02200	Additional sheets: <i>WES x 1</i>	884
Trench:	Grave fills	Treatment: <i>B&amp;TB COLLECTED</i> <i>- FABRIC RECOVERY - LIPS</i>
Site sub-div: <i>S.C.</i>	Grave cut:	Finds <i>MISSING</i>
Plan no: <i>6</i>	Skeleton: <i>GOOD</i>	None <input checked="" type="checkbox"/>
Section no:	Matrix location: <i>884</i> <i>885</i>	Breastplate
Co-ordinates:	Preservation:	Grip
Levels	Neg No:	Hinge
Slide No.	Description	Bracket
<p><i>ADULT SKELETON - EAST WEST</i> <i>WOODEN COFFIN.</i></p> <p>Discussion</p> <p>Shape, dimensions and distinguishing characteristics</p> <p>LID</p> <p>HEAD</p> <p>BASE</p>		
Recorder: <i>M</i>	Date: <i>8.11.00</i>	Initials:

Site Code

Context

**Outer Coffin**

Sample Ret.

0200

884

Recording Date ..... 13/2/01 .....

Associated Numbers .....

Condition ..... 1 .....

Dep. Plate

Legible  No

Inscription

82609?

Fabric lead  ormolou  brass  tin plated pewter  gilt tin   
 iron  silvered tin  enamelled  other ..... Sample Ret.

**Shape of dep. plate** ?

square  rectangle  shield  tapered  lozenge   
 cartouche  oval  other .....

**Upholstery**

colour ..... shoddy  velvet  other ..... Sample Ret.

**Construction**

butt joint  mitred  pitched  other .....

Grip plate  Fabric = ormolou  brass  tin plated pewter  gilt tin   
 iron  silvered tin  enamelled  other ..... Sample Ret.

Grip  Fabric = ormolou  brass  iron  Sample Ret.

Design swag of rose  horseshoe  cherub's head  plain

other .....

Grip bolts  Corner bolts  Type = gilt brass  brass  iron

other ..... Sample Ret.

Lid motifs  other ..... Sample Ret.

Escutcheons  other ..... Sample Ret.

Upholstery nails  brass  gilt brass  silvered brass  iron  enamelled

other ..... Sample Ret.

Fixings  panel nails  screws  hinges  lace  Sample Ret.

Timber type ..... Sample Ret.

**Interpretation / Comments**

.....  
 .....

SITE	COFFIN RECORD SHEET	CONTEXT NO.
02-100		885
Trench:	Additional sheets:	Treatment:
Site sub-div: DRAIN SC	Grave fills	BONES COLLECTED.
Plan no: 6	Grave cut:	Finds None ✓
Section no:	Skeleton: GOOD	Breastplate Grip
Co-ordinates:	Matrix location: <del>W/P</del> <del>884</del> <del>885</del> 884 885 886	Hinge Bracket
Levels	Preservation:	Fixing nails Shroud pins
Slide No.	Neg No:	Fabric Other finds
Description <b>BUILT STEEL - EAST WEST ALIGNED.</b> <b>WOODEN COFFIN</b>		
Discussion		
Shape, dimensions and distinguishing characteristics  LID  HEAD  BASE		
Recorder: <i>TJ</i>	Date: 8-11-00	Initials:

SITE	COFFIN RECORD SHEET	CONTEXT NO.
02200		886
Trench:	Additional sheets:	Treatment:
Site sub-div: S.C.	Grave fills	BONES COLLECTED
Plan no: 6	Grave cut:	Finds
		None
Section no:	Skeleton:	Breastplate
		Grip ✓
Co-ordinates:	Matrix location: 885 886	Hinge
		Bracket
Levels	Preservation: Good	Fixing nails
		Shroud pins
Slide No.	Neg No:	Fabric
		Other finds

Description

ADULT SKULL  
ORIENTATED EAST - WEST

Discussion

Shape, dimensions and distinguishing characteristics

LID

HEAD

BASE

Recorder: M	Date: 8.11.00	Initials:
-------------	---------------	-----------

SITE	COFFIN RECORD SHEET		CONTEXT NO.
02100			887.
Trench:	Additional sheets:	Treatment: BONES LIFTED.	
Site sub-div: SC.	Grave fills		
Plan no: 6.	Grave cut:	Finds None ✓	
Section no:	Skeleton: <i>Good.</i>	Breastplate Grip	
Co-ordinates:	Matrix location: <i>(883)</i> <i>(887)</i>	Hinge Bracket	
Levels	Preservation:	Fixing nails Shroud pins	
Slide No.	Neg No:	Fabric Other finds	
<p><b>Description</b> <i>ADOLESCENT EAST-WEST BURIAL. WOODEN COFFIN.</i></p> <p><b>Discussion</b></p>			
<p><b>Shape, dimensions and distinguishing characteristics</b></p> <p>LID</p> <p>HEAD</p> <p>BASE</p>			
Recorder: <i>M</i>	Date: <i>8.11.00</i>	Initials:	

SITE		COFFIN RECORD SHEET		CONTEXT NO.	
OL200				888	
Trench:		Additional sheets:		Treatment:	
Site sub-div: SC.		Grave fills		BONES LIFTED.	
Plan no: 6.		Grave cut:		Finds	
Section no:		Skeleton: GOOD		None	
Co-ordinates:		Matrix location: 0/L 889.		Breastplate	
Levels		Preservation:		Grip	
Slide No.		Neg No:		Hinge	
Description		(WOOD) ADULT BURIAL		Bracket	
Discussion		EAST-WEST		Fixing nails	
Shape, dimensions and distinguishing characteristics				Shroud pins	
LID				Fabric	
HEAD				Other finds	
BASE					
Recorder: D <sub>2</sub>		Date: 8.11.00		Initials:	

Site Code

Context

01200

888

**Outer Coffin**

Sample Ret.

Recording Date ..... 21/2/01 .....

Associated Numbers .....

Condition ..... 2 .....

Dep. Plate

Legible  in parts. - bits missing.

Inscription "Charles ..... / (wife of) / In the County of D. .... / Esq<sup>re</sup>. / Born 24<sup>th</sup> Aug<sup>th</sup> / 1784 / Obiit 25<sup>th</sup> Feb<sup>y</sup> / 1830. new type - see sheet.

Fabric lead  ormolou  brass  tin plated pewter  gilt tin   
 iron  silvered tin  enamelled  other ..... Sample Ret.   
*black polished*

**Shape of dep. plate**

square  rectangle  shield  tapered  lozenge   
 cartouche  oval  other .....

**Upholstery**

colour ..... shoddy  velvet  other ..... Sample Ret.

**Construction**

butt joint  mitred  pitched  other .....

**Grip plate**

Fabric = ormolou  brass  tin plated pewter  gilt tin   
 iron  silvered tin  enamelled  other ..... Sample Ret.   
*frags on ew of grip - wid.*

**Grip**

Fabric = ormolou  brass  iron  x 2 Sample Ret.   
 Design swag of rose  horseshoe  cherub's head  (4)'s plain

**Grip bolts**

Corner bolts  Type = gilt brass  brass  iron

**Lid motifs**

other .....

**Escutcheons**

other .....

**Upholstery nails**

brass  gilt brass  silvered brass  iron  enamelled

**Fixings**

panel nails  screws  hinges  lace  Sample Ret.

**Timber type**

Sample Ret.

**Interpretation / Comments**

.....  
 .....



SITE	COFFIN RECORD SHEET	CONTEXT NO.
04100		889
Trench:	Additional sheets:	Treatment:
Site sub-div: SC	Grave fills	BONES.
Plan no: 6.	Grave cut:	Finds
Section no:	Skeleton: GOOD.	None
Co-ordinates:	Matrix location:	Breastplate
Levels	Preservation: U/L 888.	Grip
Slide No.:	Neg No:	Hinge
		Bracket
		Fixing nails
		Shroud pins
		Fabric
		Other finds
Description: WOODEN COFFIN ADULT BURIAL EAST - WEST (NE - SW)		
Discussion		
Shape, dimensions and distinguishing characteristics		
LID		
HEAD		
BASE		
Recorder: M	Date: 8-11-00	Initials:

# Coffin Recording Sheet

Site Code

Context

**Outer Coffin**

Sample Ret.

OKR00

889

Recording Date ..... 16/2/01 .....

Associated Numbers .....

Condition .....

Dep. Plate

Legible

Inscription

Fabric lead  ormolou  brass  tin plated pewter  gilt tin   
 iron  silvered tin  enamelled  other ..... Sample Ret.

**Shape of dep. plate**

square  rectangle  shield  tapered  lozenge   
 cartouche  oval  other .....

**Upholstery**

colour ..... shoddy  velvet  other ..... Sample Ret.

**Construction**

butt joint  mitred  pitched  other .....

**Grip plate**

Fabric = ormolou  brass  tin plated pewter  gilt tin   
 iron  silvered tin  enamelled  other ..... Sample Ret.

*Proton rev of grip-wood.*

**Grip**

Fabric = ormolou  brass  iron  Sample Ret.

*X1  
4*

**Design**

swag of rose  horseshoe  cherub's head  plain

other .....

**Grip bolts**

Corner bolts  Type = gilt brass  brass  iron

other ..... Sample Ret.

**Lid motifs**

other ..... Sample Ret.

**Escutcheons**

other ..... Sample Ret.

**Upholstery nails**

brass  gilt brass  silvered brass  iron  enamelled

other ..... Sample Ret.

**Fixings**

panel nails  screws  hinges  lace  Sample Ret.

**Timber type**

..... Sample Ret.

**Interpretation / Comments**

.....  
 .....

SITE: 02R00	COFFIN RECORD SHEET	CONTEXT NO. 890
Trench:	Additional sheets:	Treatment: BONES / DNA
Site sub-div: SC.	Grave fills:	
Plan no: 6	Grave cut:	Finds: None
Section no:	Skeleton: poor	Breastplate: ✓ Grip: ✓ x 2 + STODOLSK
Co-ordinates:	Matrix location: 890	Hinge
Levels:	Preservation: V. SQUASHED / LAPSIDED / V. CORRODED / TOP / SIDES BOT.	Bracket
Slide No.:	Neg No:	Fixing nails
		Shroud pins
		Fabric
		Other finds:

**Description** ADULT Pb COFFIN - PINNED. TRACES OF WOOD OUTER + INNER. EAST-WEST ALIGNED. Pb Inner Soldered Plate legible

**Discussion**

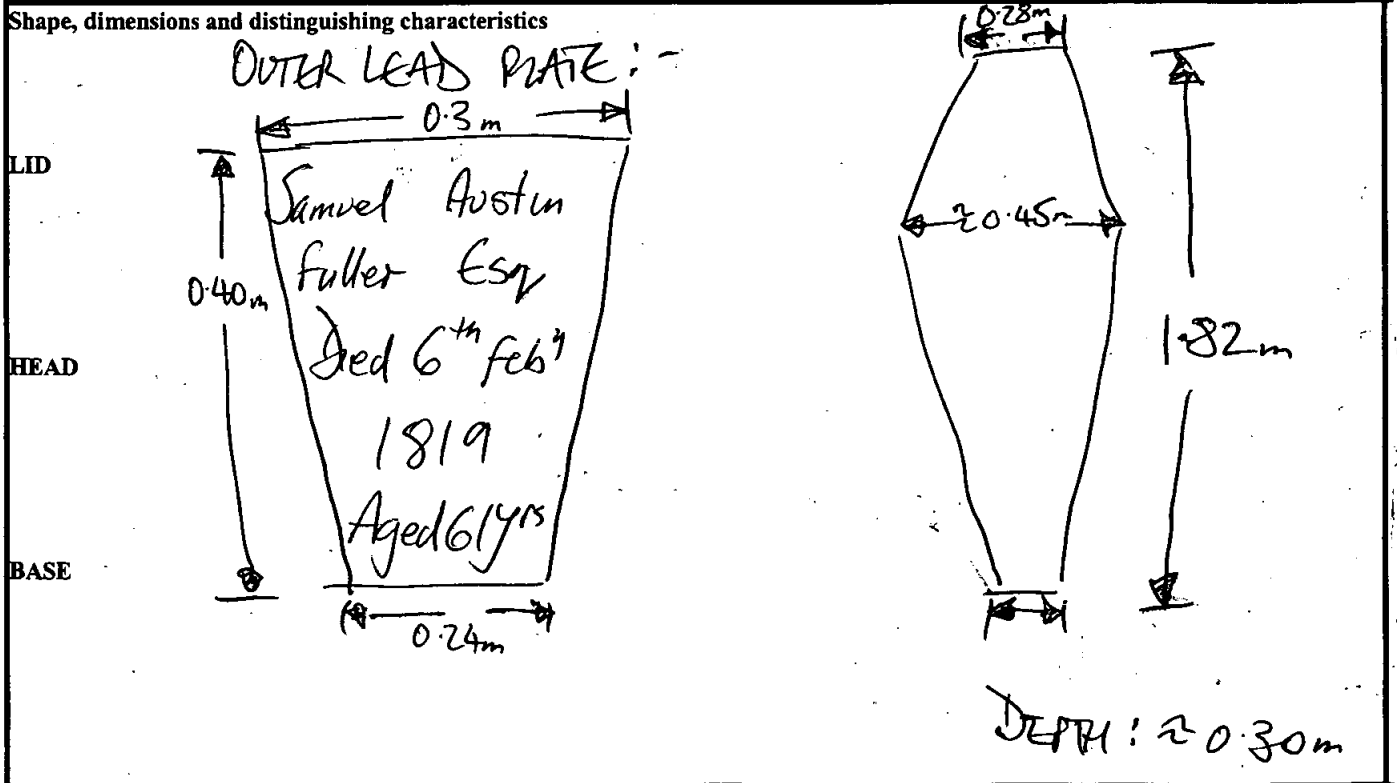

Recorder: M Date: 8.11.00 Initials:

# Coffin Recording Sheet

**Outer Coffin**

Sample Ret.

Site Code

Context

OKR00

890

Recording Date ..... 20/2/01 .....

Associated Numbers .....

Condition ..... 3 .....

Dep. Plate

Legible

Inscription "Samuel Austin/Fullex Esq<sup>re</sup>/Died 6<sup>th</sup> Feb<sup>y</sup>/1849/Aged 61 Yrs"

*new type w/ (outer) border 1184*

Fabric lead  ormolou  brass  tin plated pewter  gilt tin   
 iron  silvered tin  enamelled  other ..... Sample Ret.

**Shape of dep. plate**

square  rectangle  shield  tapered  lozenge   
 cartouche  oval  other .....

**Upholstery**

colour ..... shoddy  velvet  other ..... Sample Ret.

**Construction**

butt joint  mitred  pitched  other .....

**Grip plate**

Fabric = ormolou  brass  tin plated pewter  gilt tin   
*Frogs on rev of grip - unid*  
 iron  silvered tin  enamelled  other ..... Sample Ret.

**Grip**

Fabric = ormolou  brass  iron  <sup>3x</sup> <sub>(4)'s</sub> Sample Ret.

**Design**

swag of rose  horseshoe  cherub's head  plain

other .....

**Grip bolts**

**Corner bolts**  Type = gilt brass  brass  iron

other ..... Sample Ret.

**Lid motifs**

other ..... Sample Ret.

**Escutcheons**

other ..... Sample Ret.

**Upholstery**

*studs*  
 brass  gilt brass  silvered brass  iron  enamelled

other ..... *1x000 2x0 = 5 studs* ..... Sample Ret.

**Fixings**

panel nails  screws  hinges  lace  Sample Ret.

**Timber type**

Sample Ret.

**Interpretation / Comments**

.....  
 .....

SITE	COFFIN RECORD SHEET	CONTEXT NO.
02100		891
Trench:	Additional sheets:	Treatment:
Site sub-div: 52	Grave fills:	BONES LIFTED.
Plan no: 6	Grave cut:	Finds
Section no:	Skeleton: GOOD CONDITION.	None
Co-ordinates:	Matrix location: 890 891	Breastplate
Levels	Preservation: V. CORRODED - TOP / SIDES / BASE	Grip <del>XXXXXX</del> ✓
Slide No.:	Neg No:	Hinge
		Bracket
		Fixing nails
		Shroud pins
		Fabric
		Other finds

Description: **ADULT COFFIN**  
**EAST-WEST ALIGNED**  
**TRACES OF OUTER COFFIN + INNER WOOD COFFIN.**

Discussion: **NO NAME**

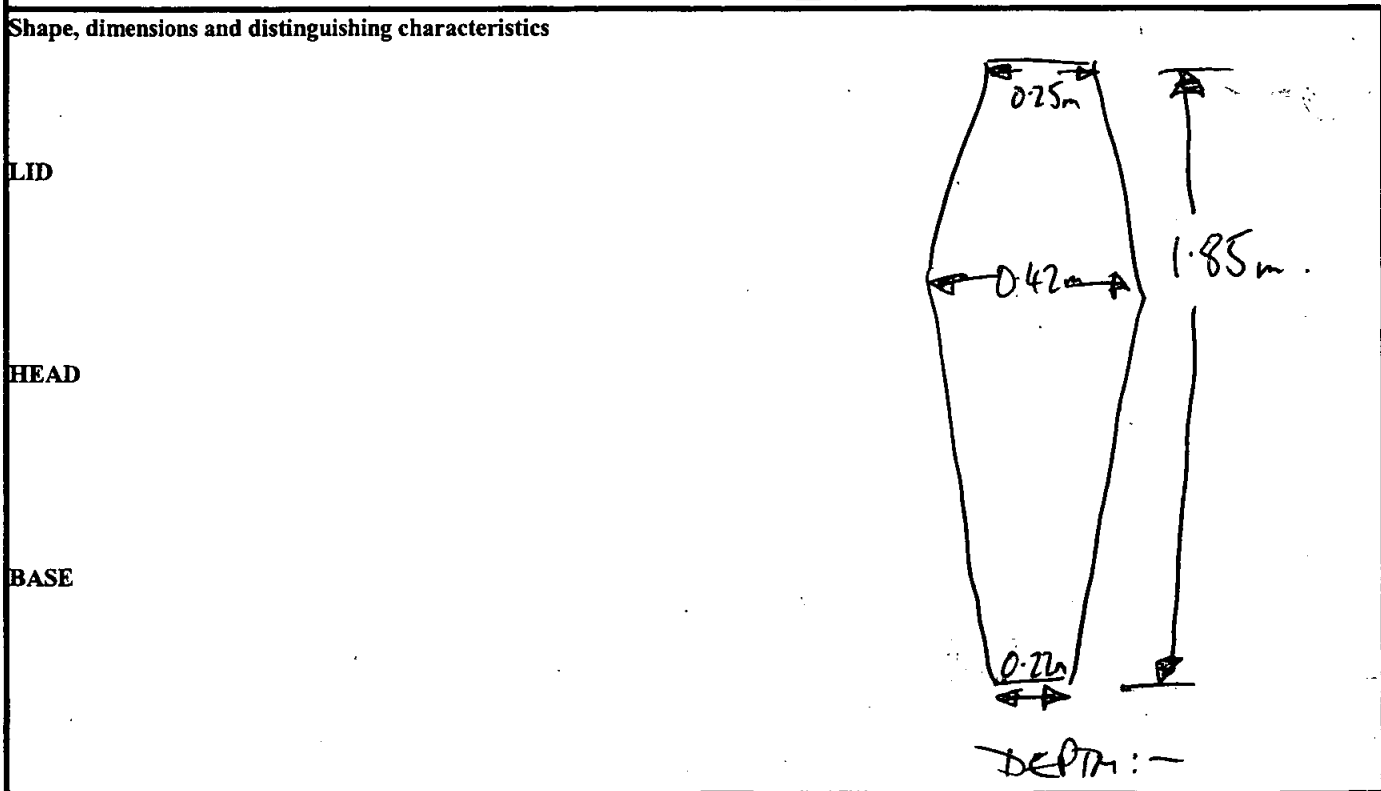

Recorder: <i>VS</i>	Date: 8.11.00	Initials:
---------------------	---------------	-----------

**Outer Coffin**

Sample Ret.

Site Code

Context

Recording Date ..... 21/2/01 .....

04200

891

Associated Numbers .....

Condition .....

Dep. Plate

Legible

Inscription

Fabric lead  ormolou  brass  tin plated pewter  gilt tin   
 iron  silvered tin  enamelled  other ..... Sample Ret.

**Shape of dep. plate**

square  rectangle  shield  tapered  lozenge   
 cartouche  oval  other .....

**Upholstery**

colour ..... shoddy  velvet  other ..... Sample Ret.

**Construction**

butt joint  mitred  pitched  other .....

Grip plate  Fabric = ormolou  brass  tin plated pewter  gilt tin   
 iron  silvered tin  enamelled  other ..... Sample Ret.

Grip  Fabric = ormolou  brass  iron  1 x (4) Sample Ret.

Design swag of rose  horseshoe  cherub's head  plain   
 other .....

Grip bolts  Corner bolts  Type = gilt brass  brass  iron

other ..... Sample Ret.

Lid motifs  other ..... Sample Ret.

Escutcheons  other ..... Sample Ret.

Upholstery nails  brass  gilt brass  silvered brass  iron  enamelled   
 other ..... Sample Ret.

Fixings  panel nails  screws  hinges  lace  Sample Ret.

Timber type ..... Sample Ret.

**Interpretation / Comments**

.....  
 .....

db.

SITE		COFFIN RECORD SHEET		CONTEXT NO. 892	
Trench: OUGOO		Additional sheets: YES x1		Treatment:	
Site sub-div: S.C.		Grave fills		DOWNS COVERED	
Plan no: 6		Grave cut:		Finds None ✓	
Section no:		Skeleton: FOUND		Breastplate Grip	
Co-ordinates:		Matrix location: (892)		Hinge Bracket	
Levels		Preservation:		Fixing nails Shroud pins	
Slide No.		Neg No:		Fabric Other finds	
Description EDW ADULT BORAK. WOODEN COFFIN					
Discussion					
Shape, dimensions and distinguishing characteristics					
LID					
HEAD					
BASE					
Recorder: [Signature]		Date: 10/11/00		Initials:	

# Coffin Recording Sheet

Site Code

Context

**Outer Coffin**

Sample Ret.

*Orloo*

*892*

Recording Date ..... *12/12/00* .....

Associated Numbers .....

Condition .....

Dep. Plate

Legible

Inscription

Fabric lead       ormolou       brass       tin plated pewter       gilt tin   
 iron       silvered tin       enamelled       other .....      Sample Ret.

**Shape of dep. plate**

square       rectangle       shield       tapered       lozenge   
 cartouche       oval       other .....

**Upholstery**

colour .....      shoddy       velvet       other .....      Sample Ret.

**Construction**

butt joint       mitred       pitched       other .....

Grip plate       Fabric = ormolou       brass       tin plated pewter       gilt tin   
 iron       silvered tin       enamelled       other .....      Sample Ret.

Grip       Fabric = ormolou       brass       iron  *x1*      Sample Ret.

Design      swag of rose       horseshoe       cherub's head  *(A)*      plain   
 other .....

Grip bolts       Corner bolts       Type =      gilt brass       brass       iron   
 other .....      Sample Ret.

Lid motifs       other .....

Escutcheons       other .....

Upholstery nails            brass       gilt brass       silvered brass       iron       enamelled   
 other .....      Sample Ret.

Fixings            panel nails       screws       hinges       lace       Sample Ret.

Timber type .....      Sample Ret.

**Interpretation / Comments**

.....  
 .....



db.

SITE OLK00	COFFIN RECORD SHEET	CONTEXT NO. 893
Trench:	Additional sheets: YES XI.	Treatment:
Site sub-div: S.C.	Grave fills	BONE CONTACT
Plan no: 6	Grave cut:	Finds None ✓
Section no:	Skeleton: GOOD	Breastplate Grip
Co-ordinates:	Matrix location: 841 893	Hinge Bracket
Levels	Preservation: good	Fixing nails Shroud pins
Slide No.	Neg No:	Fabric Other finds

Description E A W ADULT BURIAL. PD LINED COFFIN, TINN BAND SOLDERED TOP & BASE. MACHINE ASSEMBLED, NO DIMENSIONS

Discussion

Shape, dimensions and distinguishing characteristics

LID

NO NAME.

HEAD

BASE

Recorder: DM/DM	Date: 10/11/00	Initials:
-----------------	----------------	-----------

# Coffin Recording Sheet

Site Code

Context

02200

893

**Outer Coffin**

Sample Ret.

Recording Date ..... 6/12/00 .....

Associated Numbers .....

Condition .....

Dep. Plate  —

Legible

Inscription

Fabric lead       ormolou       brass       tin plated pewter       gilt tin   
 iron       silvered tin       enamelled       other .....      Sample Ret.

**Shape of dep. plate**

square       rectangle       shield       tapered       lozenge   
 cartouche       oval       other .....

**Upholstery**

colour ..... shoddy       velvet       other .....      Sample Ret.

**Construction**

butt joint       mitred       pitched       other .....

**Grip plate**

Fabric = ormolou       brass       tin plated pewter       gilt tin   
*Progs on rev of grip-unid.*  
 iron       silvered tin       enamelled       other .....      Sample Ret.

**Grip**

Fabric = ormolou       brass       iron  *x2*      Sample Ret.

**Design**

swag of rose       horseshoe       cherub's head       plain  *⊕'s*

other .....

**Grip bolts**

**Corner bolts**       Type = gilt brass       brass       iron

other .....      Sample Ret.

**Lid motifs**

other .....      Sample Ret.

**Escutcheons**

other .....      Sample Ret.

**Upholstery nails**

brass       gilt brass       silvered brass       iron       enamelled

other .....      Sample Ret.

**Fixings**

panel nails       screws       hinges       lace       Sample Ret.

**Timber type** .....

Sample Ret.

**Interpretation / Comments**

.....  
 .....