

Islington, Old Street, St Lukes  
CLR00

Box 4 File 1

B. PRIMARY CONTACT RECORDS - N° 894-1025

SCAN PDF

FILMING INSTRUCTIONS

Submitter OASouth

No. of CD copies: 2

Headings

Site information

Line 1: [OASouth] County:[Greater London] Parish:[Islington] Site:[Old Street, St Lukes]

Site code[OLR00]

Line 2: Excavators name[A. Boyle]

Line 3:

Classification of material

Tick if present

Index to archive	
Introduction	
A:Final Report	
A:Publication Report	
B:Site Data – Text: Diary/Daybook/Fieldnotes	
B: Site Data – Text: General Summaries	
B: Site Data – Text: Primary Context Records <i>Nº 894-1025</i>	✓
B: Site Data – Text: Synthesised Context Records	
B: Site Data – Text: Survey Reports	
B: Site Data – Text: Catalogue of Drawings	
B: Site Data – Text: Primary Drawings	
B: Site Data – Text: Synthesised Drawings	
C: Finds Data – Text: Primary Finds Data	
C: Finds Data – Text: Synthesised Finds Data	
C: Finds Data – Text: Specialist Reports	
C: Finds Data – Text: Box/Bag List	
D: Catalogue of Photos/Slides/Videos/X--rays	
E: Environmental/Ecofact Data: Primary Records	
E: Environmental/Ecofact Data: Synthesised Records	
E: Environmental/Ecofact Data: Specialist Reports	
F: Documentary	
F: Press and Publicity	
G: Correspondence	
H: Miscellaneous	

SITE		CONTEXT			SITE		NAME	
CODE: OL 200		CHECKLIST			ST. LUKE'S CHURCH,		1 SUNNINGDALE	
Context No	Type	Excavated with Segments	Relationships	Dug	Drawn		Matrix	Comments
					Section	Plan		
894	BURIAL	CRYP1, BR43		DM	/	7	Y	PD Coffin (WENT)
895	u	u	U/L 896	DM	/	7	Y	u
896	u	u	U/L 895	DM	/	7	Y	u
897	u	u		DM	/	7	N	u
898	u	u	U/L 860	DM	/	7	Y	u
899	u	u		DM	/	7	Y	u INFANT
900	u	CRYP1, BR42	U/L 847	DM	/	7	Y	u
901	u	CRYP1 BR43	U/L 896	DM	/	7	Y	Pb Coffin WENT
902	u	u	U/L 896	DM	/	7	Y	u WENT
903	u	u	U/L 897	DM	/	7	N	u WENT
904	u	u	U/L 894/899	DM	/	7	Y	u
905	u	u	U/L 901/902/3	DM	-	7	Y	u
906	u	CRYP1 BR42		DM	-	7	Y	u
907	u	u		DM	-	7	Y	u
908	u	u		DM	-	7	Y	u
909	u	u		DM	-	7	Y	u
910	u	u		DM	-	7	Y	u
911	u	u		DM	/	7	Y	u
912	u	u		DM	/	7	Y	u
913	u	u		DM	/	7	Y	u
914	u	u		DM	/	7	Y	u
915	u	u		DM	/	7	N	u
916	u	u		DM	/	7	Y	u
917	u	u		DM	/	7	Y	u
918	u	u		DM	/	7	N	u
919	BURIAL	CRYP1 BR43	U/L 961	DM	/	7	N	Pb Coffin AHEAD
920	u	u	U/L 962	DM	/	7	Y	u
921	u	u		DM	/	7	Y	u
922	u	u		DM	/	7	Y	u
923	u	u		DM	/	7	Y	u
924	u	CRYP1 BR42		DM	/	7	Y	u
925	u	CRYP1 BR43		DM	/	7	Y	u
926	u	u		DM	/	7	N	u

SITE		CONTEXT				SITE <i>ST LUKES CHURCH,</i>		NAME: <i>ISLINGTON</i>	
CODE: <i>OLR00</i>		CHECKLIST							
Context No	Type	Excavated with Segments	Relationships	Dug	Drawn		Matrix	Comments	
					Section	Plan			
<i>B</i> 927	<i>BURIAL</i>	<i>S.C.</i>	<i>U/L 923</i> <i>O/L 928</i>	<i>DM/DM</i>	<i>—</i>	<i>6</i>	<i>Y</i>	<i>BURIAL - INFANT</i>	
<i>B</i> 928	<i>"</i>	<i>"</i>	<i>U/L 927</i>	<i>DM/DM</i>	<i>—</i>	<i>6</i>	<i>Y</i>	<i>Pb COFFIN - ADULT</i>	
<i>B</i> 929	<i>"</i>	<i>"</i>	<i>U/L 922</i> <i>O/L 930</i>	<i>DM/DM</i>	<i>—</i>	<i>6</i>	<i>N</i>	<i>BURIAL - ADULT</i>	
<i>B</i> 930	<i>"</i>	<i>"</i>	<i>U/L 929</i> <i>O/L 931</i>	<i>DM/DM</i>	<i>—</i>	<i>6</i>	<i>N</i>	<i>" - INFANT</i>	
<i>B</i> 931	<i>"</i>	<i>"</i>	<i>U/L 930</i>	<i>DM/DM</i>	<i>—</i>	<i>6</i>	<i>N</i>	<i>" - ADULT</i>	
<i>B</i> 932	<i>"</i>	<i>"</i>	<i>U/L 931</i>	<i>DM</i>	<i>—</i>	<i>6</i>	<i>N</i>	<i>" ADULT</i>	
<i>B</i> 933	<i>"</i>	<i>"</i>	<i>OL 935</i>	<i>DM</i>	<i>—</i>	<i>6</i>	<i>N</i>	<i>Pb COFFIN ADULT</i>	
<i>B</i> 934	<i>"</i>	<i>"</i>	<i>OL 936</i>	<i>DM</i>	<i>—</i>	<i>6</i>	<i>Y</i>	<i>" "</i>	
<i>B</i> 935	<i>"</i>	<i>"</i>	<i>U/L 935</i>	<i>DM</i>	<i>—</i>	<i>6</i>	<i>Y</i>	<i>" "</i>	
<i>B</i> 936	<i>"</i>	<i>"</i>	<i>U/L 934</i>	<i>DM</i>	<i>—</i>	<i>6</i>	<i>Y</i>	<i>" "</i>	
<i>B</i> 937	<i>"</i>	<i>"</i>	<i>U/L 935</i>	<i>DM</i>	<i>—</i>	<i>6</i>	<i>N</i>	<i>BURIAL - ADULT</i>	
<i>B</i> 938	<i>"</i>	<i>"</i>	<i>—</i>	<i>DM</i>	<i>—</i>	<i>6</i>	<i>Y</i>	<i>Pb COFFIN - ADULT</i>	
<i>B</i> 939	<i>"</i>	<i>"</i>	<i>U/L 940</i>	<i>DM</i>	<i>—</i>	<i>6</i>	<i>N</i>	<i>Pb COFFIN - ADULT</i>	
<i>B</i> 940	<i>"</i>	<i>"</i>	<i>OL 939</i>	<i>DM</i>	<i>—</i>	<i>6</i>	<i>N</i>	<i>BURIAL - JUVENILE</i>	
<i>B</i> 941	<i>"</i>	<i>"</i>	<i>U/L 939</i>	<i>DM</i>	<i>—</i>	<i>6</i>	<i>N</i>	<i>BURIAL - JUVENILE</i>	
<i>B</i> 942	<i>"</i>	<i>"</i>	<i>(942) (943)</i>	<i>DM</i>	<i>—</i>	<i>6</i>	<i>N</i>	<i>BURIAL - JUVENILE</i>	
<i>B</i> 943	<i>"</i>	<i>"</i>	<i>(942) (943)</i>	<i>DM</i>	<i>—</i>	<i>6</i>	<i>N</i>	<i>BURIAL - young adult?</i>	
<i>B</i> 944	<i>"</i>	<i>"</i>	<i>U/L 941</i>	<i>DM</i>	<i>—</i>	<i>6</i>	<i>N</i>	<i>BURIAL - young adult?</i>	
<i>B</i> 945	<i>"</i>	<i>"</i>	<i>U/L 944</i>	<i>DM</i>	<i>—</i>	<i>6</i>	<i>N</i>	<i>BURIAL - JUVENILE</i>	
<i>B</i> 946	<i>"</i>	<i>"</i>	<i>U/L 945</i>	<i>DS</i>	<i>—</i>	<i>6</i>	<i>Y</i>	<i>Burial - adult (with name plate)</i>	
<i>B</i> 947	<i>"</i>	<i>"</i>	<i>OL 952</i>	<i>DM</i>	<i>—</i>	<i>6</i>	<i>N</i>	<i>BURIAL - ADULT</i>	
<i>B</i> 948	<i>"</i>	<i>"</i>	<i>OL 949</i>	<i>DM</i>	<i>—</i>	<i>6</i>	<i>N</i>	<i>BURIAL - ADULT</i>	
<i>B</i> 949	<i>"</i>	<i>"</i>	<i>U/L 948</i>	<i>DM</i>	<i>—</i>	<i>6</i>	<i>N</i>	<i>BURIAL - ADULT</i>	
<i>B</i> 950	<i>"</i>	<i>"</i>	<i>OL 954</i>	<i>DM</i>	<i>—</i>	<i>6</i>	<i>N</i>	<i>BURIAL - ADULT</i>	
<i>B</i> 951	<i>"</i>	<i>"</i>	<i>U/L 952</i>	<i>DM</i>	<i>—</i>	<i>6</i>	<i>N</i>	<i>Pb COFFIN - ADULT</i>	
<i>B</i> 952	<i>"</i>	<i>"</i>	<i>OL 951</i>	<i>DM</i>	<i>—</i>	<i>6</i>	<i>N</i>	<i>BURIAL - INFANT</i>	
<i>B</i> 953	<i>"</i>	<i>"</i>	<i>U/L 951</i>	<i>DM</i>	<i>—</i>	<i>6</i>	<i>N</i>	<i>BURIAL - ADULT</i>	
<i>B</i> 954	<i>"</i>	<i>"</i>	<i>U/L 950</i>	<i>DM</i>	<i>—</i>	<i>6</i>	<i>N</i>	<i>BURIAL - INFANT</i>	
<i>B</i> 955	<i>"</i>	<i>"</i>	<i>—</i>	<i>DM</i>	<i>—</i>	<i>6</i>	<i>N</i>	<i>BURIAL - INFANT</i>	
<i>B</i> 956	<i>"</i>	<i>"</i>	<i>OL 957</i>	<i>DM</i>	<i>—</i>	<i>6</i>	<i>N</i>	<i>BURIAL - ADULT</i>	
<i>B</i> 957	<i>"</i>	<i>"</i>	<i>U/L 956</i> <i>OL 958</i>	<i>DM</i>	<i>—</i>	<i>6</i>	<i>N</i>	<i>BURIAL - ADULT</i>	
<i>B</i> 958	<i>"</i>	<i>"</i>	<i>U/L 957</i>	<i>DM</i>	<i>—</i>	<i>6</i>	<i>N</i>	<i>BURIAL - ADULT</i>	
<i>B</i> 959	<i>"</i>	<i>"</i>	<i>U/L 993</i>	<i>DM</i>	<i>—</i>	<i>6</i>	<i>N</i>	<i>BURIAL - ADULT</i>	

SITE		CONTEXT			SITE ST LUKES CHURCH,		
CODE: CLR 00		CHECKLIST			NAME: ISLINGTON		
Context No	Type	Excavated with Segments	Relationships	Dug	Drawn		Comments
					Section	Plan	
960	Burial	crypt Bay 3	v/L 360	Dm	/	7	N Pb ADULT COFFIN
961	"	"	v/L 919	Dm	/	7	Y "
962	"	"	v/L 920	Dm	/	7	Y "
963	"	"		Dm	/	7	Y "
964	Burial	crypt Bay 3	v/L 960	Dm	/	7	Y Pb INFANT COFFIN
965	"	"	v/L 923	Dm	/	7	N Pb ADULT COFFIN
966	"	"	v/L 922	Dm	/	7	Y "
967	"	"	v/L 921	Dm	/	7	Y "
968	Burial	Crypt Bay 3	v/L 960	Dm	/	7	Y pb adult coffin.
969	"	"	v/L 926	Dm	/	7	Y pb adult coffin
970	"	"	v/L 925	Dm	/	7	Y p.b adult coffin.
971	"	"		Dm	/	7	Y "
972	Burial	Crypt Bay 3	v/L 973	Dm	/	7	Y p.b. infant.
973	Burial	Crypt Bay 3	v/L 972	Dm	/	7	Y p.b adult coffin
974	Burial	Crypt Bay 4	v/L 979	Dm	/	7	N p.b adult coffin
975	Burial	Crypt Bay 4	v/L 978	Dm	/	7	N pb adult coffin
976	Burial	Crypt Bay 4		Dm	/	7	Y pb adult coffin
977	Burial	Crypt Bay 4		Dm	/	7	Y pb adult coffin
978	Burial	Crypt Bay 4	v/L 975	Dm	/	7	N truncated legs in p.b.
979	Burial	Crypt Bay 4	v/L 974	Dm	/	7	N adult p.b coffin
980	Burial	Crypt Bay 3	v/L 978	Dm	/	7	Y adult p.b coffin
981	Burial	Crypt Bay 3	v/L 978	Dm	/	7	Y adult p.b coffin
982	Burial	Crypt Bay 3	v/L 981	Dm	/	7	Y adult p.b coffin
983	Burial	"	v/L 980	Dm	/	7	N adult p.b coffin
984	Burial	Crypt Bay 3	v/L 980	Dm	/	7	N adult p.b coffin
985	"	"	Bay 3		/	7	Y " "
986	"	"	Bay 3		/	7	Y " "
987	"	"	in vault 22 Bay 3		/	7	N sub adult pb coffin
988	"	"	in vault 22 Bay 3		/	7	N adult p.b coffin
989	"	"	Bay 3		/	7	Y adult p.b coffin
990	"	"	adj to 989 Bay 3		/	7	Y adult p.b coffin
991	"	Crypt Bay 3	adj to 992		/	7	Y infant p.b.
992	"	"	adj to 911 Bay 3		/	7	N infant p.b.

SITE CODE: OLROO		CONTENTS CHECKLIST			SITE: ST LUCAS CHURCH NAME: ISLINGTON			
Context No	Type	Excavated with Segments	Relationships	Dug	Drawn		Matrix NAMED?	Comments
					Section	Plan		
B 993	BURIAL	S.C.	U/L 999	DM	—	G	N	BURIAL - ADULT
NA/B 994	BURIAL	"	"	DM	—	G	Y	BURIAL - ADULT
B 995	"	"	O/L 997	DM	—	G	N	Pb-COFFIN - ADULT
B 996	"	"	<del>U/L 997</del>	DS	—	G	N	BURIAL - ADULT
B 997	"	"	U/L 995	DM	—	G	N	Pb-COFFIN - INFANT
B 998	"	"	U/L 997	DM	—	G	N	BURIAL - ADULT
B 999	"	"	O/L 1000	DM	—	G	N	BURIAL - ADULT
B 1000	"	"	U/L 999	DM	—	G	N	BURIAL - ADULT
B 1001	"	"	U/L 1000	DM	—	G	N	BURIAL - ADULT
B 1002	"	"	U/L 1001	DM	—	G	N	BURIAL - ADULT
B 1003	"	"	U/L 1002	DM	—	G	N	BURIAL - JUVENILE
B 1004	"	"	U/L 1003	DM	—	G	N	BURIAL - JUVENILE
B 1005	CUT	"	U/L <del>997</del>	DM	—	—	—	CUT OF PIT
B 1006	FM	"	F.O. 1005	DM	—	—	—	FM OF PIT
B 1007	BURIAL	"	O/L 1008	DM	—	G	N	Pb-COFFIN - ADULT
A/B 1008	"	"	U/L 1007	DM	—	G	Y	Pb-COFFIN - ADULT
NA/B 1009	"	"	O/L 1014	DM	—	G	Y	Pb-COFFIN - ADULT
B 1010	"	"	O/L	DM	—	G	N	Pb-COFFIN - ADULT
B 1011	"	"	U/L 1008	DM	—	G	N	Pb-COFFIN - ADULT
B 1012	"	"	U/L 1011	DM	—	G	N	BURIAL - ADULT
B 1013	"	"	U/L 1012	DM	—	G	N	BURIAL - ADULT
B 1014	"	"	U/L 1009	DM	—	G	N	BURIAL - ADULT
B 1015	"	"	U/L 1014	DM	—	G	N	BURIAL - ADULT
B 1016	"	"	O/L 1017	DM	—	G	N	BURIAL - ADULT
B 1017	"	"	U/L 1016	DM	—	G	N	BURIAL - ADULT
B 1018	"	"	U/L 1017	DM	—	G	N	BURIAL - ADULT
B 1019	"	"	U/L 1018	DM	—	G	N	BURIAL - JUVENILE
B 1020	"	"	U/L 1018	DM	—	G	N	BURIAL - INFANT
B 1021	"	"	U/L 1019	DM	—	G	N	<del>BURIAL - ADULT</del> Pb-COFFIN
B 1022	"	"	"	DM	—	G	Y	BURIAL - ADULT
B 1023	"	"	U/L 1024	DM	—	G	N	BURIAL - ADULT
B 1024	"	"	O/L 1023	DM	—	G	N	BURIAL - INFANT
B 1025	"	"	U/L 1023	DM	—	G	N	BURIAL - ADULT

BURIALS THIS SHEET = 31

db.

SITE OVR 00	COFFIN RECORD SHEET	CONTEXT NO. 894
Trench:	Additional sheets:	Treatment:
Site sub-div: <i>WALL, BMS</i>	Grave fills	<i>* Necropolis</i>
Plan no: <i>7</i>	Grave cut:	Finds None <input checked="" type="checkbox"/>
Section no:	Skeleton:	Breastplate Grip
Co-ordinates:	Matrix location: <i>(894)</i>	Hinge Bracket
Levels	Preservation: <i>Good</i>	Fixing nails Shroud pins
Slide No.	Neg No:	Fabric Other finds

Description *NW S INFANT BURIAL. IN LINED COFFIN PAINT SOLIDIFIED POLY  
FOAM TO COFFIN I.D. SOLIDIFIED IS BREAST OF COFFIN. TRACES OF COFFIN  
WOOD PRESENT.*

Discussion

Shape, dimensions and distinguishing characteristics

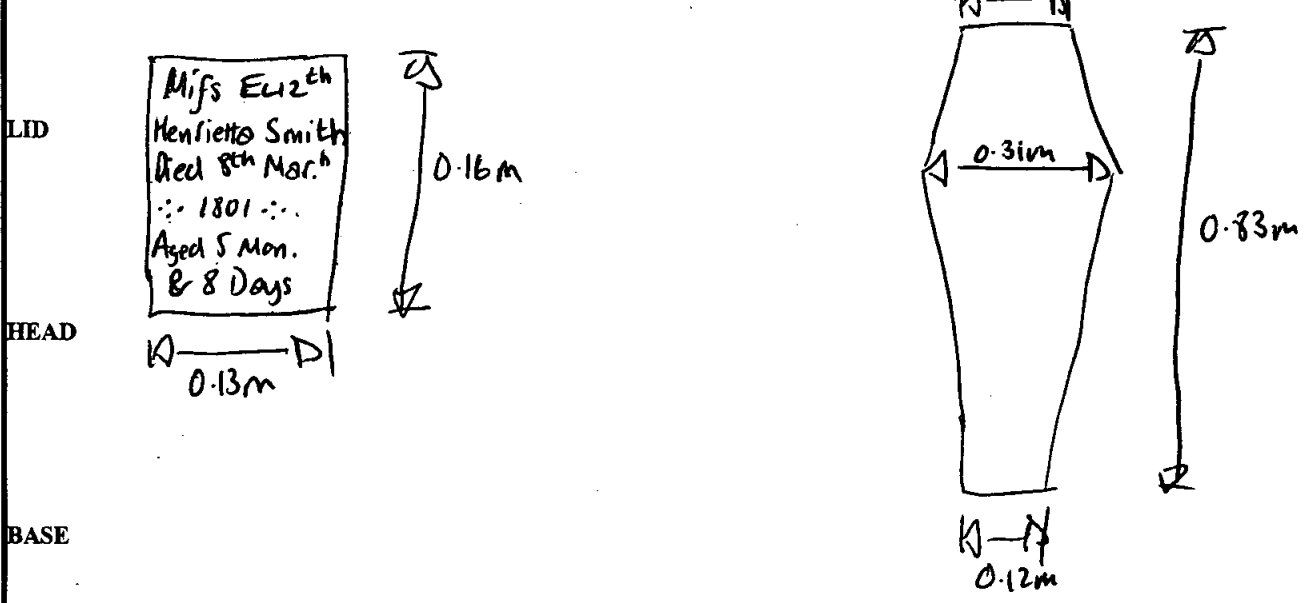

*DEPTH = 0.23m*

Recorder: <i>DM</i>	Date: <i>03/11/00</i>	Initials:
---------------------	-----------------------	-----------

Ab.

SITE	COFFIN RECORD SHEET	CONTEXT NO.
OUR 00		895
Trench:	Additional sheets:	Treatment:
Site sub-div: CAUPT, BMM 3	Grave fills:	BONE/DNA COLLECTED
Plan no: 7	Grave cut:	Finds None ✓
Section no:	Skeleton:	Breastplate Grip
Co-ordinates:	Matrix location: 895 896	Hinge Bracket
Levels:	Preservation: GOOD	Fixing nails Shroud pins
Slide No.:	Neg No.:	Fabric Other finds

Description W-E ADULT BURIAL. Pb lined coffin, BAND SOLIDIFIED TOP & BASE. Coffin I.D. ENGRAVED TO BREAST OF COFFIN. Coffin AT HEAD HAS BEEN OPENED BY WORMS. TRACES OF OUTER WOOD ABSENT. INNER WOOD - STEAM BENT AT SHOULDER. SKULL MISSING.

Discussion

Shape, dimensions and distinguishing characteristics

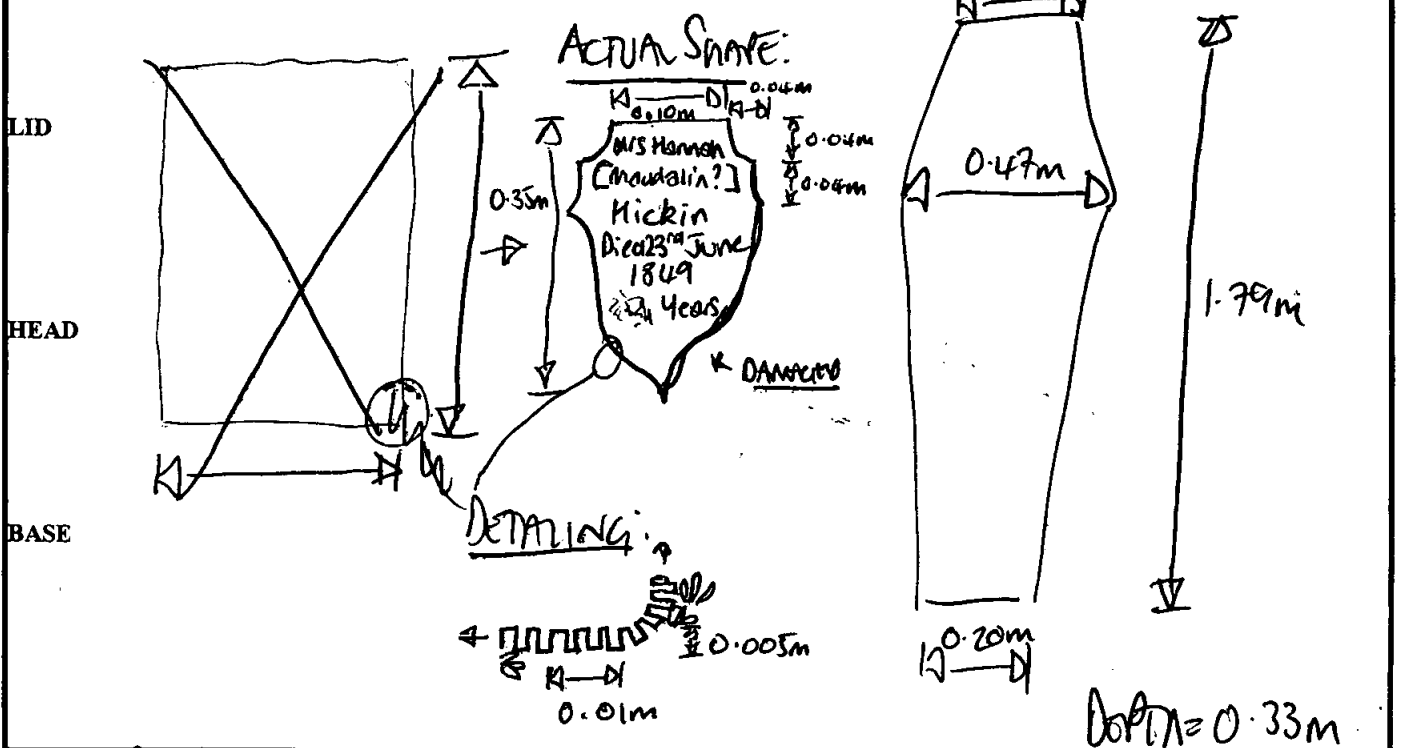

Recorder: <i>ARM</i>	Date: 03/11/00	Initials:
----------------------	----------------	-----------



db.

SITE <b>OR 00</b>	COFFIN RECORD SHEET	CONTEXT NO. <b>896</b>
Trench:	Additional sheets:	Treatment:
Site sub-div: <b>CH4/T, BM 3</b>	Grave fills	<b>Neapolous</b>
Plan no: <b>7</b>	Grave cut:	Finds
Section no:	Skeleton:	None <input checked="" type="checkbox"/>
Co-ordinates:	Matrix location: <b>895</b> <b>896</b>	Breastplate
Levels	Preservation: <b>Good</b>	Grip
Slide No.	Neg No:	Hinge
		Bracket
		Fixing nails
		Shroud pins
		Fabric
		Other finds

Description **W & E ADULT BURIAL. NO LID OR COFFIN PINCH SOLD FOR TOP & BASE. OUTER WOOD PRESENT. NO I.D. PLATE ~~PRESENT~~ TO COFFIN GREAT. CROSS MATCHING PRESENT ON PROCESSION, AND I.D. PLATE ENGRAVED**

Discussion **SINGLE LINE**

Shape, dimensions and distinguishing characteristics

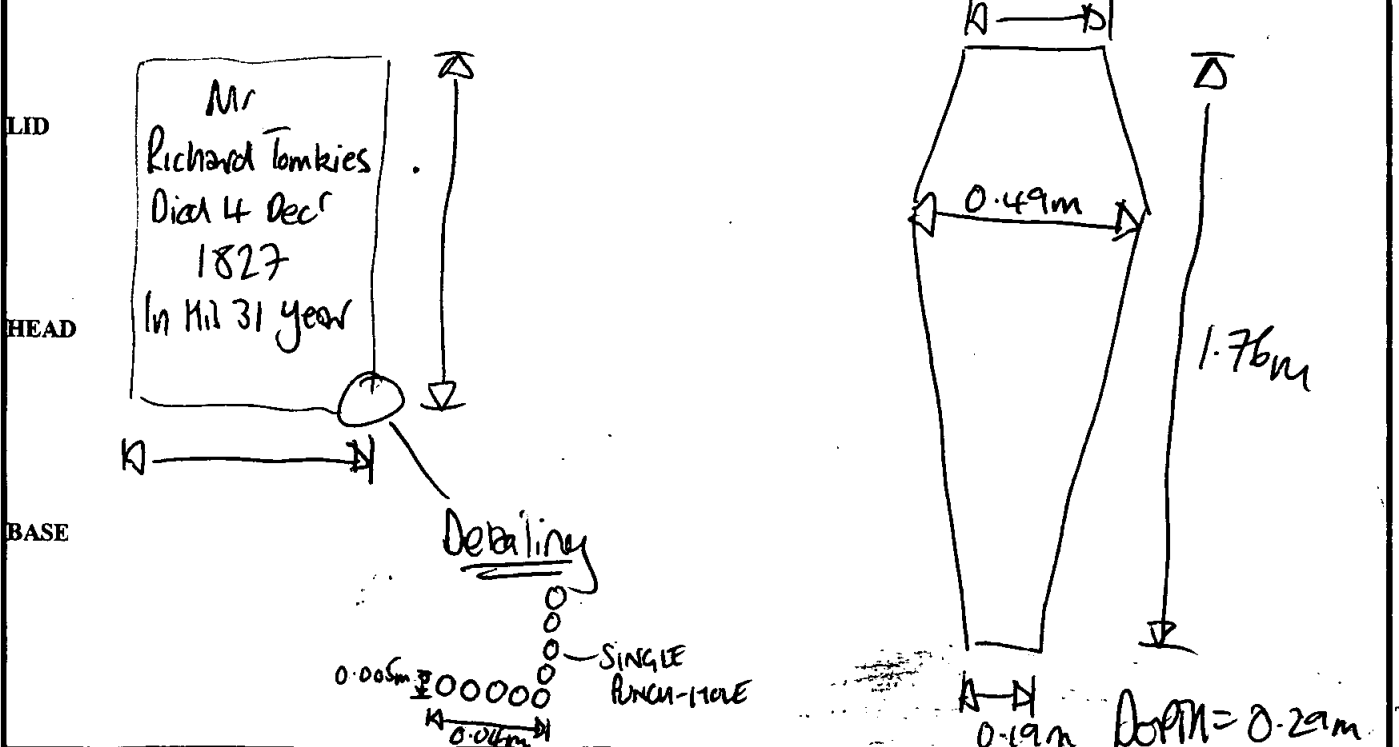

Recorder: <b>[Signature]</b>	Date: <b>03/11/00</b>	Initials:
------------------------------	-----------------------	-----------

db.

SITE <b>OLV00</b>	COFFIN RECORD SHEET	CONTEXT NO. <b>897</b>
Trench:	Additional sheets:	Treatment:
Site sub-div: <b>OLV1, BMS</b>	Grave fills	<b>Bone Collected</b>
Plan no: <b>7</b>	Grave cut:	Finds None ✓
Section no:	Skeleton:	Breastplate Grip
Co-ordinates:	Matrix location: <b>(897)</b>	Hinge Bracket
Levels	Preservation: <b>four</b>	Fixing nails Shroud pins
Slide No.	Neg No:	Fabric Other finds

**Description** W-E ADULT BURIAL. Pb lined coffin, BAND REMOVED TOP & BASE. TRACES OF OAKWOOD PRESENT. ROBBED COFFIN AT BREAST. NO NAME, SKULL MISSING.

**Discussion**

**Shape, dimensions and distinguishing characteristics**

LID

No NAME

HEAD

BASE

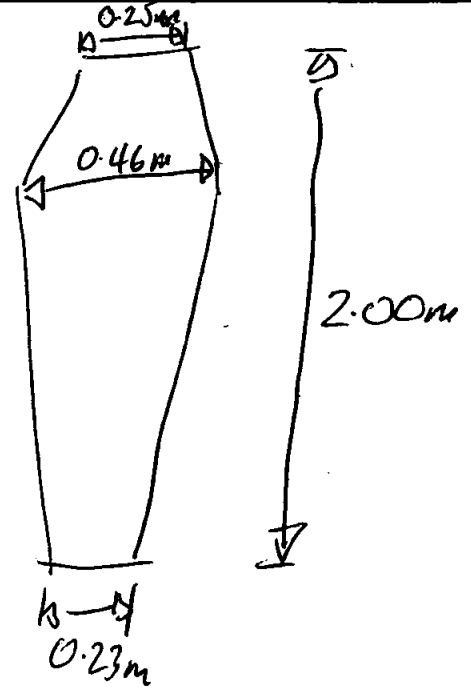

DEPTH = 0.30m

Recorder: <b>PM</b>	Date: <b>03/11/00</b>	Initials:
---------------------	-----------------------	-----------

db-

SITE	COFFIN RECORD SHEET	CONTEXT NO.
OUR 00		898
Trench:	Additional sheets: 4/5 x 1	Treatment:
Site sub-div: C4A, B13	Grave fills	Bone/DNA Collected.
Plan no: 7	Grave cut:	Finds None
Section no:	Skeleton:	Breastplate <input checked="" type="checkbox"/> Grip
Co-ordinates:	Matrix location: 898 860	Hinge Bracket
Levels	Preservation: Average	Fixing nails Shroud pins
Slide No.	Neg No:	Fabric Other finds

Description W-E ADULT BURIAL. Pb LINED COFFIN, NARROW BAND SOLDERED TO FT BASE. Pb COFFIN I.D. SOLDERED TO BREAST OF COFFIN. OUTER WOOD TRACES PRESENT. BREASTPLATE PINNED TO OUTER COFFIN.

Discussion

Shape, dimensions and distinguishing characteristics

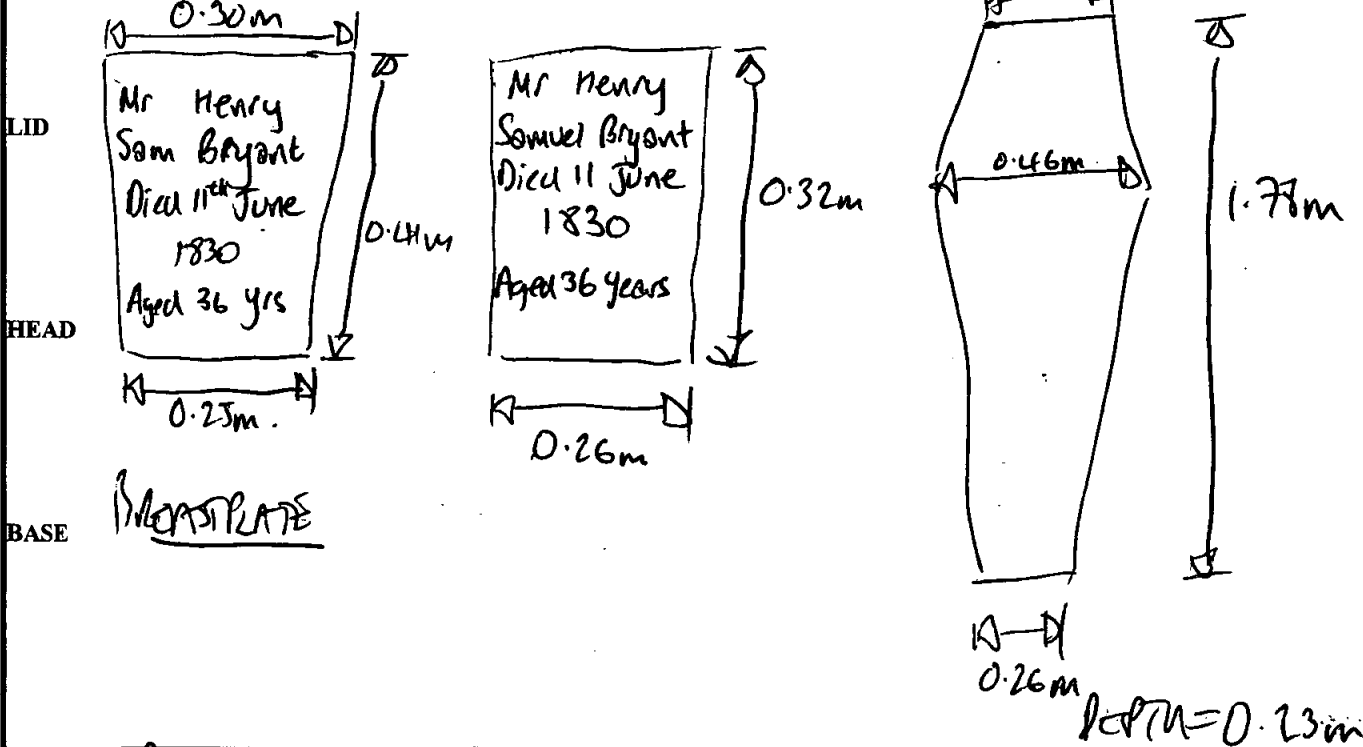

Recorder: ABM	Date: 05/11/00	Initials:
---------------	----------------	-----------

Outer Coffin

Sample Ret:

Site Code

Context

Recording Date ..... 3/11/00 .....

OH200

898

Associated Numbers .....

Condition ..... 3 .....

Dep. Plate

Legible

Inscription "Mr Henry <sup>Sam</sup> ~~Wm~~ Baynt / Died 11 June / 1830 / Aged 36 Yrs"

Fabric lead  ormolou  brass  tin plated pewter  gilt tin   
 iron  silvered tin  enamelled  other ..... Sample Ret.

(2) w/ 53A outer border.

Shape of dep. plate

square  rectangle  shield  tapered  lozenge   
 cartouche  oval  other ..... Black polished.

Upholstery

colour ..... shoddy  velvet  other ..... Sample Ret.

Construction

butt joint  mitred  pitched  other .....

Grip plate

Fabric = ormolou  brass  tin plated pewter  gilt tin

iron  silvered tin  enamelled  other ..... Sample Ret.

Grip

Fabric = ormolou  brass  iron  Sample Ret.

Design

swag of rose  horseshoe  cherub's head  plain

other .....

Grip bolts

Corner bolts  Type = gilt brass  brass  iron

other ..... Sample Ret.

Lid motifs

other ..... Sample Ret.

Escutcheons

other ..... Sample Ret.

Upholstery nails

brass  gilt brass  silvered brass  iron  enamelled

other ..... Sample Ret.

Fixings

panel nails  screws  hinges  lace  Sample Ret.

Timber type .....

Sample Ret.

Interpretation / Comments

.....  
 .....

db.

SITE <u>04200</u>	COFFIN RECORD SHEET	CONTEXT NO. <u>899</u>
Trench:	Additional sheets:	Treatment:
Site sub-div: <u>CRUPT, BA-13</u>	Grave fills:	<u>→ Necropolis</u>
Plan no: <u>7</u>	Grave cut:	Finds
Section no:	Skeleton:	None <input checked="" type="checkbox"/>
Co-ordinates:	Matrix location: <u>(899)</u>	Breastplate
Levels:	Preservation: <u>Good</u>	Grip
Slide No.:	Neg No.:	Hinge
		Bracket
		Fixing nails
		Shroud pins
		Fabric
		Other finds

Description W & E WAIST BURIAL. No LINED COFFIN NARROW BAND SCRIBED TOP & SIDE. TRACKS OF CUT ON WOOD PRESIDENTI ENGRAVED COFFIN I.O. ON BREAST OF COFFIN.

Discussion

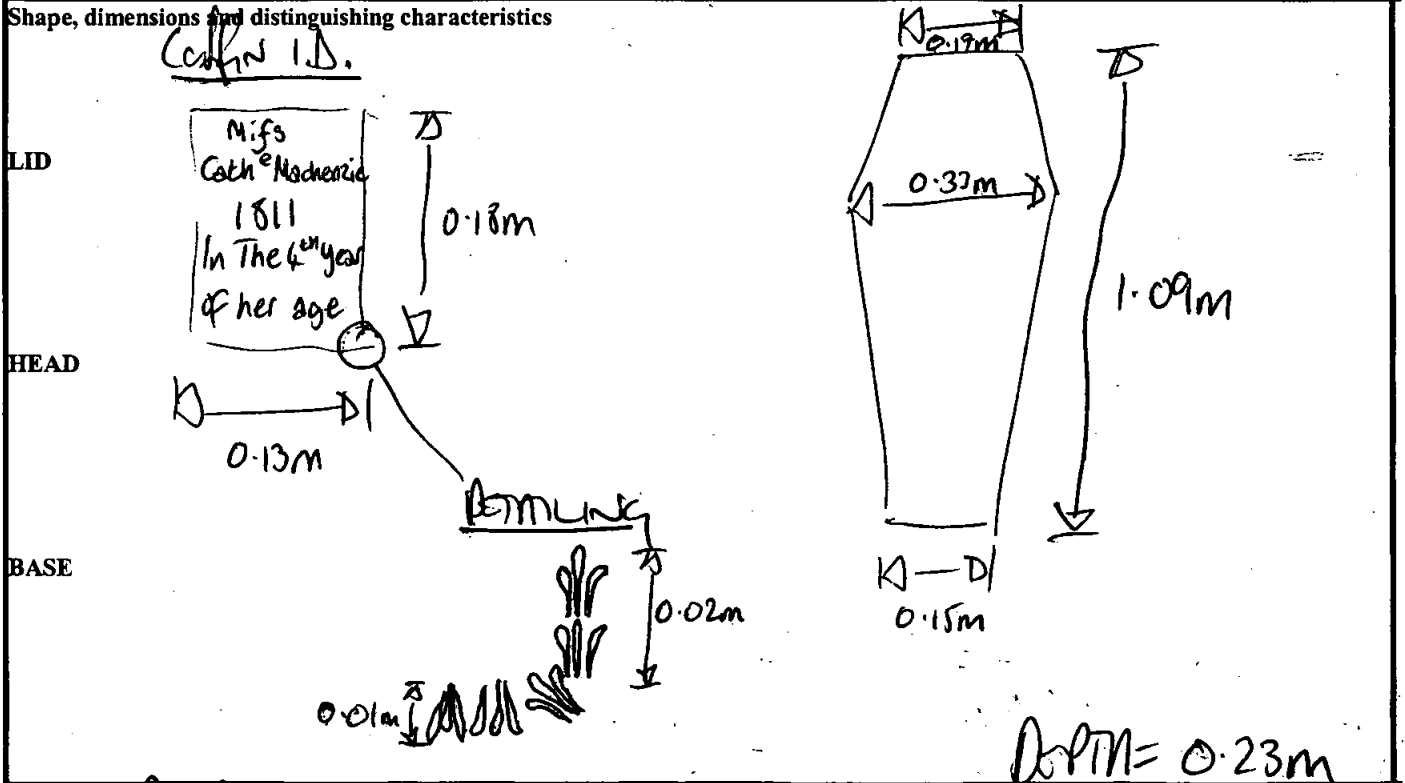

Recorder: [Signature] Date: 03/11/00 Initials:

Nb.

SITE <b>OLR00</b>	COFFIN RECORD SHEET	CONTEXT NO. <b>900</b>
Trench:	Additional sheets: <b>YES x 1</b>	Treatment:
Site sub-div: <b>CAVPT, BAY 2</b>	Grave fills	<b>NECROPOLIS</b>
Plan no: <b>7</b>	Grave cut:	Finds None <input checked="" type="checkbox"/>
Section no:	Skeleton:	Breastplate Grip
Co-ordinates:	Matrix location: <b>847</b> <b>900</b>	Hinge Bracket
Levels	Preservation: <b>POOR</b>	Fixing nails Shroud pins
Slide No.	Neg No:	Fabric Other finds

**Description** W + E. ADULT MURIAL. Pb LINED COFFIN BROAD BAND SOLDERED TOP & BASE. COFFIN IN V. POOR CONDITIONS. PLATE (I.P.) SOLDERED TO BREAST UNREADABLE. MOST OF COFFIN OVER REGRADED.

**Discussion**

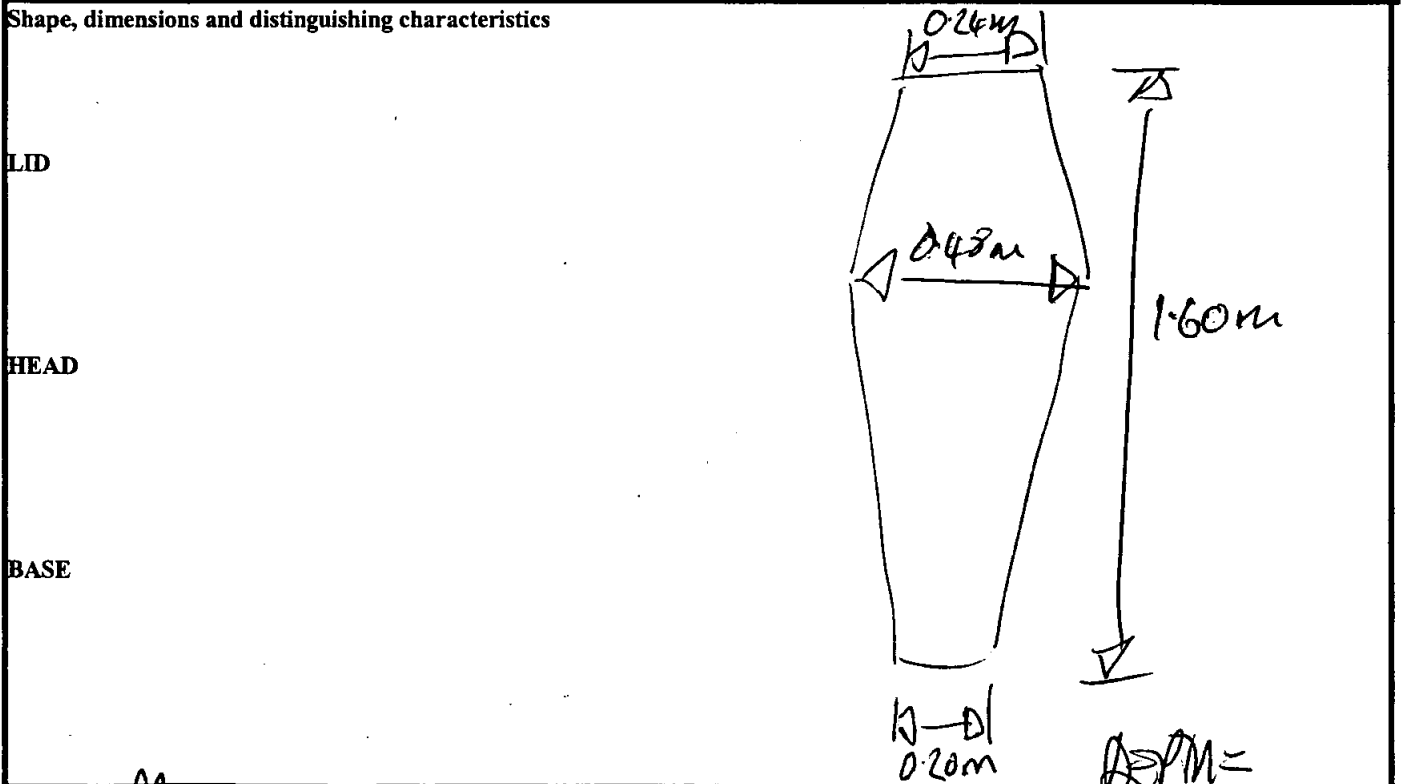

Recorder: <b>[Signature]</b>	Date: <b>03/11/00</b>	Initials: <b>[Signature]</b>
------------------------------	-----------------------	------------------------------

**Outer Coffin**

Sample Ret.

Site Code

Context

Recording Date ..... 13/11/00 .....

OLR00

900

Associated Numbers .....

Condition ..... 2 .....

Inscription  
Dep. Plate

Legible

Inscription "Mrs Elizabeth Hewet? / Died 29<sup>th</sup> Feb<sup>y</sup> / 1776 / Aged 40"

**Fabric lead**  ormolou  brass  tin plated pewter  gilt tin   
 iron  silvered tin  enamelled  other ..... Sample Ret.

**Shape of dep. plate**

square  rectangle  plain shield  tapered  lozenge   
 cartouche  oval  other .....

**Upholstery**

colour ..... shoddy  velvet  other ..... Sample Ret.

**Construction**

butt joint  mitred  pitched  other .....

**Grip plate**  Fabric = ormolou  brass  tin plated pewter  gilt tin   
 iron  silvered tin  enamelled  other ..... Sample Ret.

**Grip**  Fabric = ormolou  brass  iron  Sample Ret.

**Design** swag of rose  horseshoe  cherub's head  plain   
 other .....

**Grip bolts**  **Corner bolts**  Type = gilt brass  brass  iron   
 other ..... Sample Ret.

**Lid motifs**  other ..... Sample Ret.

**Escutcheons**  other ..... Sample Ret.

**Upholstery nails**  brass  gilt brass  silvered brass  iron  enamelled   
 other ..... Sample Ret.

**Fixings**  panel nails  screws  hinges  lace  Sample Ret.

**Timber type** ..... Sample Ret.

**Interpretation / Comments**

.....  
 .....

SITE	COFFIN RECORD SHEET	CONTEXT NO.
Oldoo		901
Trench:	Additional sheets:	Treatment:
Site sub-div: C/MT BAN 3	Grave fills	→ NEOLITHIC
Plan no: 7	Grave cut:	Finds None
Section no:	Skeleton:	Breastplate ✓ Grip
Co-ordinates:	Matrix location: U/L 806	Hinge Bracket
Levels	Preservation: Good.	Fixing nails Shroud pins
Slide No.	Neg No:	Fabric Other finds

Description PO Infant Coffin - soldered.  
WEST-EAST ORIENTATION

BREASTPLATE READS:- Mrs Emily Sarah Backhouse  
Died 6th May 1828  
Aged 11 Months

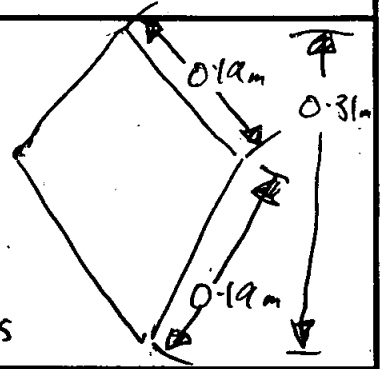

Discussion

Shape, dimensions and distinguishing characteristics

INSCRIBED PLATE:-

LID ALSO NAMED FOOT PLATE:-

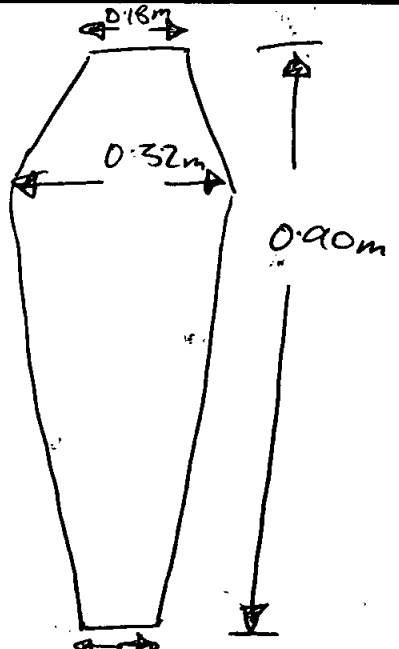
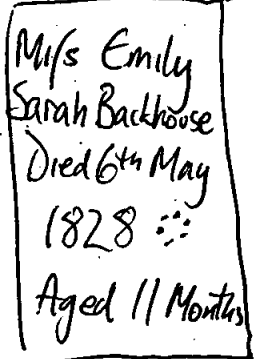
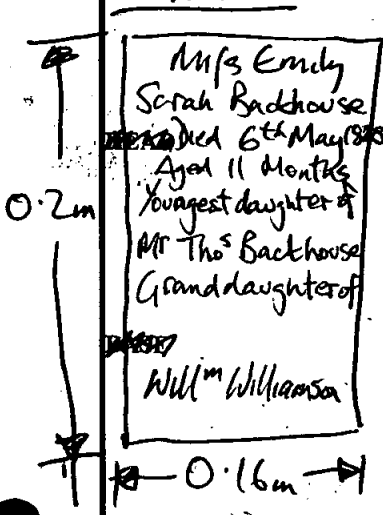

Recorder: <i>VM</i>	Date: 7.11.00	Initials:
---------------------	---------------	-----------



SITE	COFFIN RECORD SHEET	CONTEXT NO.
02200		902
Trench:	Additional sheets:	Treatment:
Site sub-div: CUMAT BAN 3	Grave fills	INTACT. → NEARLY INTACT.
Plan no: 7.	Grave cut:	Finds
Section no:	Skeleton:	None
Co-ordinates:	Matrix location:	Breastplate ✓
Levels	Preservation:	Grip
Slide No.	Neg No:	Hinge
		Bracket
		Fixing nails
		Shroud pins
		Fabric
		Other finds

Description Pb COFFIN (INFANT) - SOLDERED.  
EAST-WEST ORIENTATION  
OUTER BREASTPLATE READS:-  
MRS Emma Budd  
Died 14th May  
1815  
Aged 7 Months  
And 12 Days

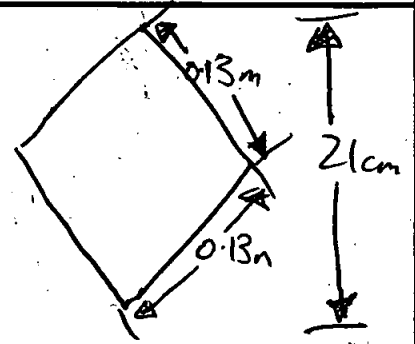

Shape, dimensions and distinguishing characteristics

INNER Pb PLATE:-

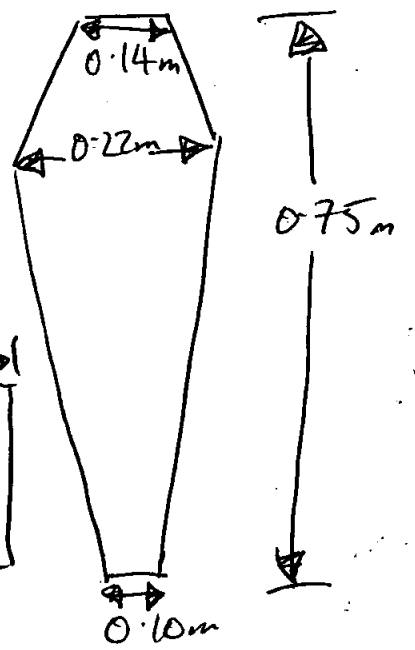
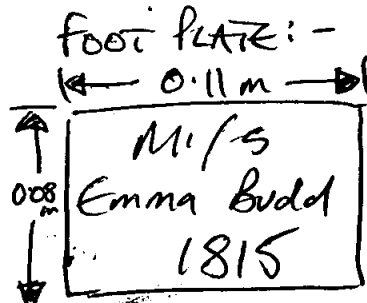
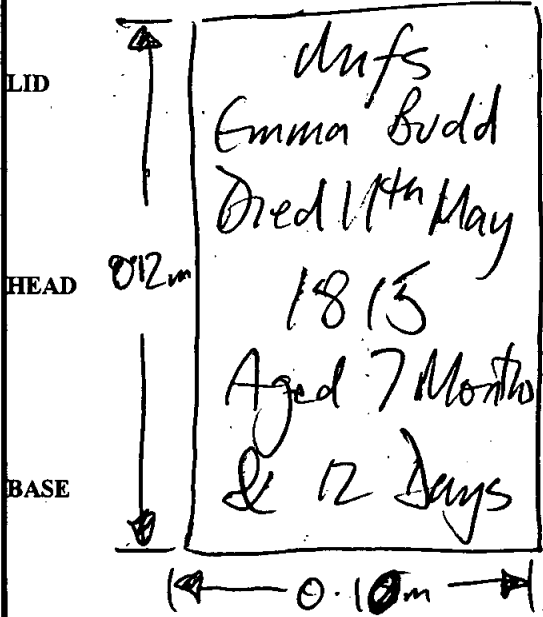

Recorder: Jm Date: 7.11.00 Initials:

db.

SITE <i>02100</i>	COFFIN RECORD SHEET	CONTEXT NO. <i>903</i>
Trench:	Additional sheets:	Treatment:
Site sub-div: <i>UNIT BAN 3</i>	Grave fills:	<i>SOOTS LIFTED</i>
Plan no: <i>7</i>	Grave cut:	
Section no:	Skeleton:	Finds None ✓
Co-ordinates:	Matrix location: <i>v/l 807</i>	Breastplate
Levels:	Preservation: <i>POOR - CORRODED + SPLIT.</i>	Grip
Slide No.	Neg No:	Hinge
		Bracket
		Fixing nails
		Shroud pins
		Fabric
		Other finds

Description *Pb COFFIN (INFANT) - SOLDERED.  
WEST-EAST ORIENTATION.*

Discussion *NO NAME*

Shape, dimensions and distinguishing characteristics

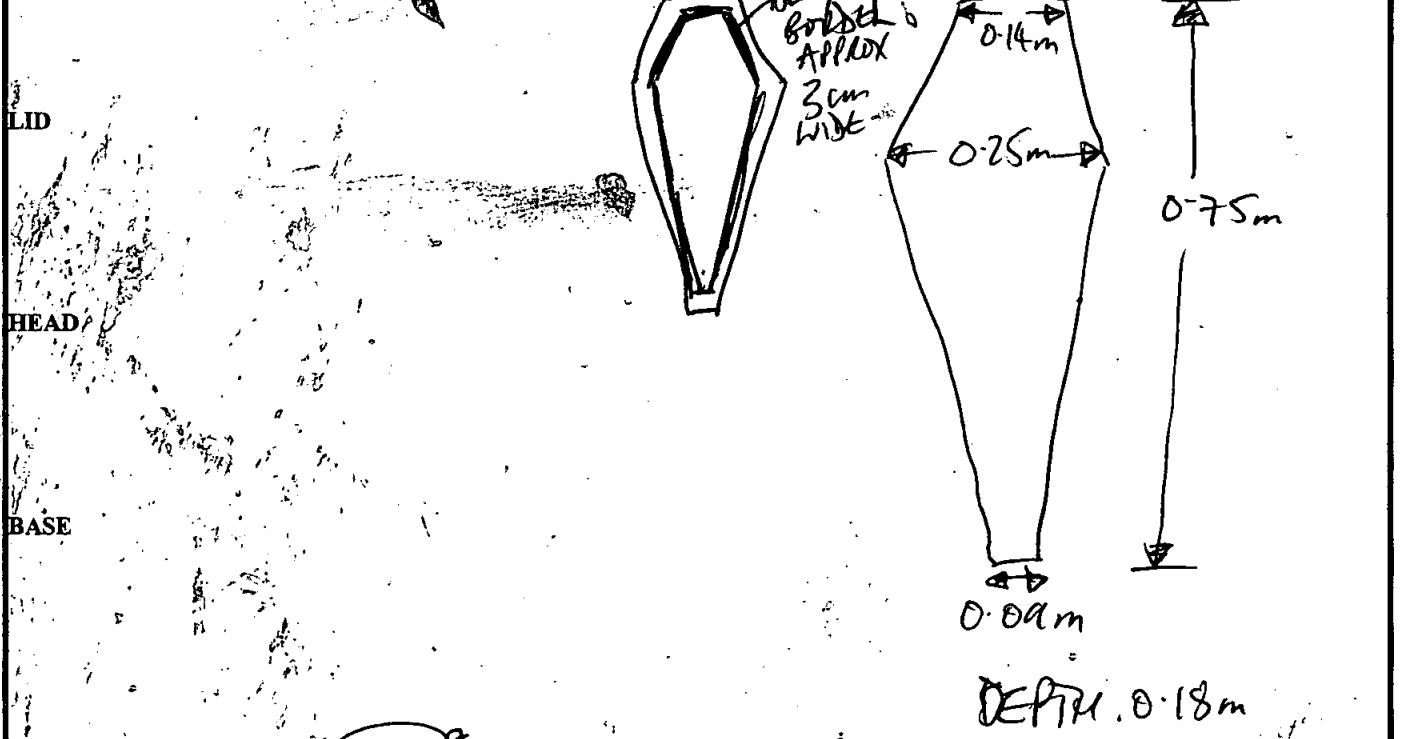

Recorder: <i>7.11.00</i>	Date: <i>7/11/00</i>	Initials:
-----------------------------	-------------------------	-----------

db.

SITE Orkoo	COFFIN RECORD SHEET	CONTEXT NO. 204
Trench:	Additional sheets:	Treatment:
Site sub-div: CUMOT BAN 3.	Grave fills:	→ NEEDLES
Plan no:	Grave cut:	Finds None ✓
Section no:	Skeleton:	Breastplate Grip
Co-ordinates:	Matrix location: U/L 894 / 899.	Hinge Bracket
Levels:	Preservation: SQUASHED BUT INTACT	Fixing nails Shroud pins
Slide No.	Neg No:	Fabric Other finds

Description Pb Coffin - SOLDERED.  
NORTH-SOUTH ORIENTATION.

Discussion

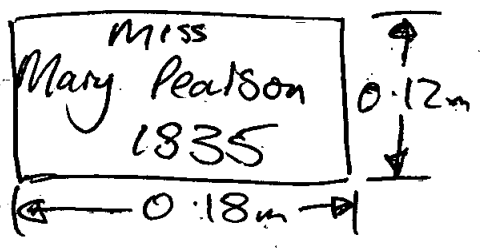

Shape, dimensions and distinguishing characteristics

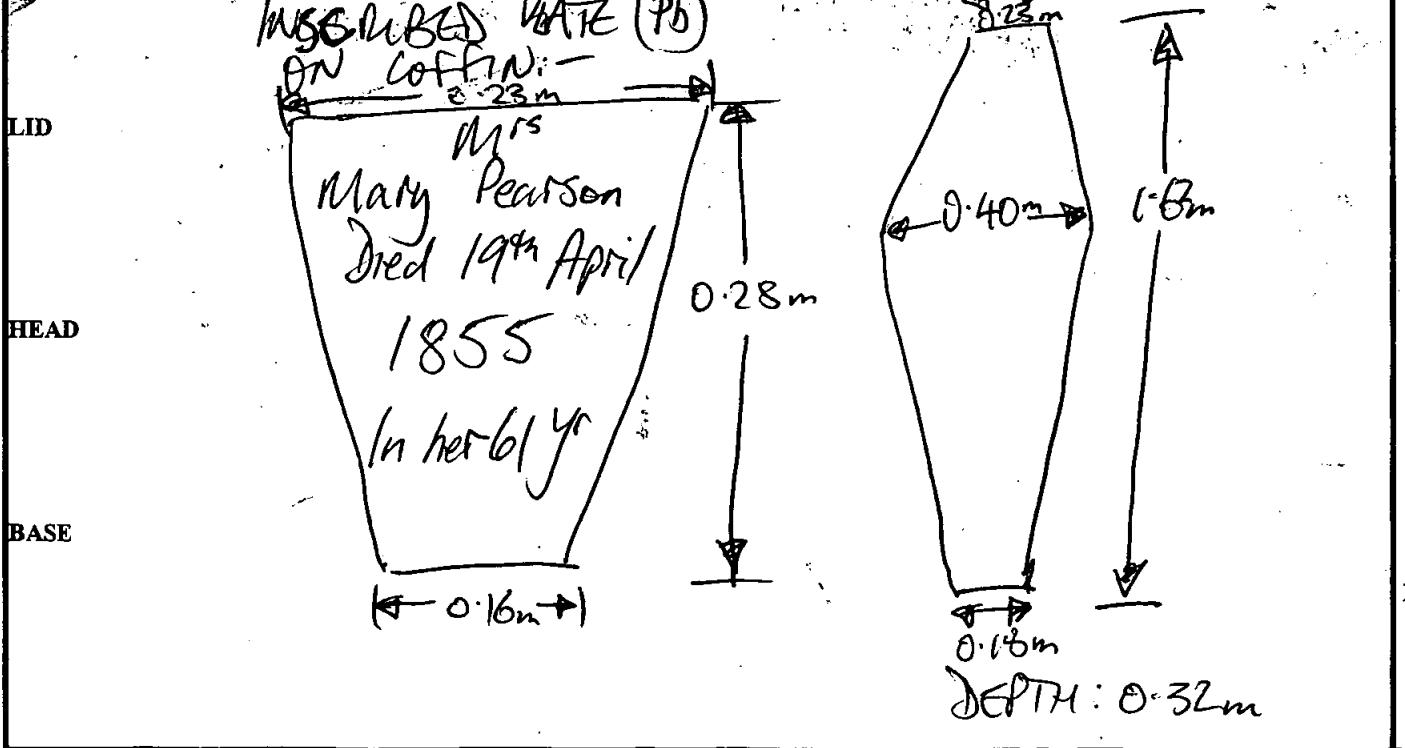

Recorder: *DM* Date: 7.11.00 Initials:

SITE		COFFIN RECORD SHEET		CONTEXT NO.	
Orlao		Additional sheets: 4/63 x 1		905	
Trench:		Grave fills		Treatment: BONES LIFTED.	
Site sub-div: Cdn BAY 3.		Grave cut:		Finds	
Plan no: 7		Skeleton:		None	
Section no:		Matrix location: U/L 901/102/903		Breastplate <input checked="" type="checkbox"/>	
Co-ordinates:		Preservation: v. poor		Grip <input checked="" type="checkbox"/>	
Levels:		Neg No:		Hinge	
Slide No.:		Fabric		Bracket	
		Other finds		Fixing nails	
				Shroud pins	

**Description** Pb ADULT Coffin BREASTPLATE DECAYED - ILLIBLE.  
 NORTH-SOUTH ORIENTATED.  
**Discussion** TRACES OF OUTER WOOD COFFIN  
 - SOLDERED.

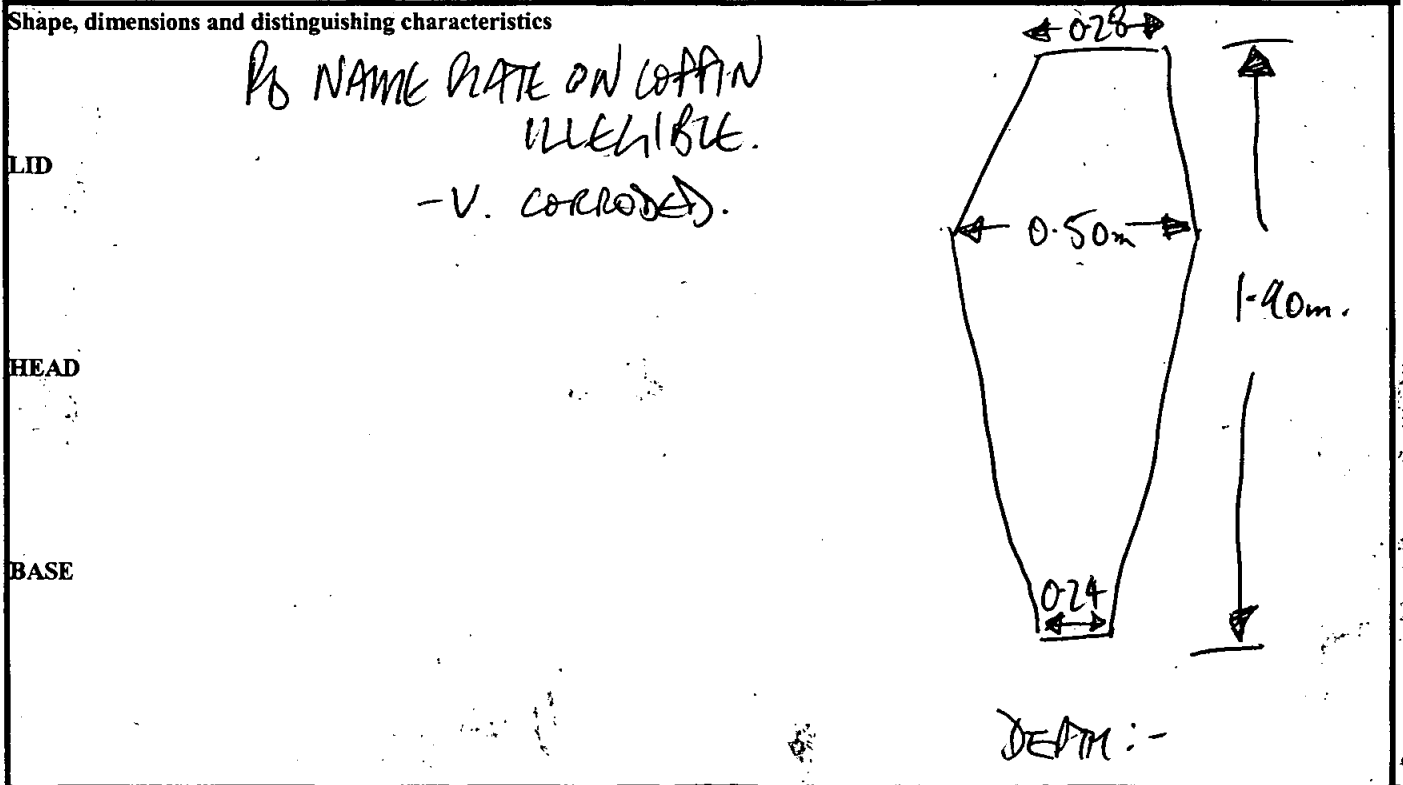

Recorder: DM Date: 7.11.00 Initials:

Site Code

Context

0200

905

**Outer Coffin**

Sample Ret.

Recording Date ..... 13/2/01 .....

Associated Numbers .....

Condition ..... 2 .....

Dep. Plate

Legible

same as 868  
- old border &  
hallmark in  
same place.  
see sheet 976

Inscription "Mr/Fred<sup>k</sup> Gibson/Died 21<sup>st</sup> Oct<sup>r</sup>/1848/  
Aged 24 Y<sup>rs</sup>"

Fabric lead

ormolou

brass   
*black polished*  
enamelled

tin plated pewter

gilt tin

iron

silvered tin

other .....

Sample Ret.

J. PRICE & CO - w/ hallmark (etched) bottom  
- J. PRICE & CO (bottom HTS)

**Shape of dep. plate**

square

rectangle

shield

tapered

lozenge

cartouche

oval

other .....

unknown.   
↔ unknown  
↔ 0.23

**Upholstery**

colour .....

shoddy

velvet

other .....

Sample Ret.

**Construction**

butt joint

mitred

pitched

other .....

Grip plate

Fabric = ormolou

brass

tin plated pewter

gilt tin

iron

silvered tin

enamelled

other .....

Sample Ret.

**Grip**

Fabric = ormolou

brass

iron

x 1

Sample Ret.

**Design**

swag of rose

horseshoe

cherub's head

(A)

plain

other .....

Grip bolts

Corner bolts

Type = gilt brass

brass

iron

other ..... Sample Ret.

**Lid motifs**

other ..... Sample Ret.

**Escutcheons**

other ..... Sample Ret.

**Upholstery nails**

brass  gilt brass  silvered brass  iron  enamelled

other ..... Sample Ret.

**Fixings**

panel nails  screws  hinges  lace  Sample Ret.

**Timber type**

Sample Ret.

**Interpretation / Comments**

.....  
.....

dp.

SITE ocloo.	COFFIN RECORD SHEET	CONTEXT NO. 906
Trench:	Additional sheets: YES x 1	Treatment: INTACT
Site sub-div: CHURCH BAY 2	Grave fills	→ NEOLITHIC
Plan no: 7.	Grave cut:	Finds: None
Section no:	Skeleton:	Breastplate Grip ✓
Co-ordinates:	Matrix location:	Hinge Bracket
Levels	Preservation: SQUASHED/corroded at side	Fixing nails Shroud pins
Slide No.	Neg No:	Fabric Other finds

Description

Pb Coffin - Adult.  
 TRACES of Outer Wood.  
 WEST - EAST ORIENTATED.

Discussion

Shape, dimensions and distinguishing characteristics

LID

HEAD

BASE

INSCRIPTION ON Pb Coffin

MRS  
 Mina Henwood  
 Died 5<sup>th</sup> October  
 1861  
 In her 39<sup>th</sup> year

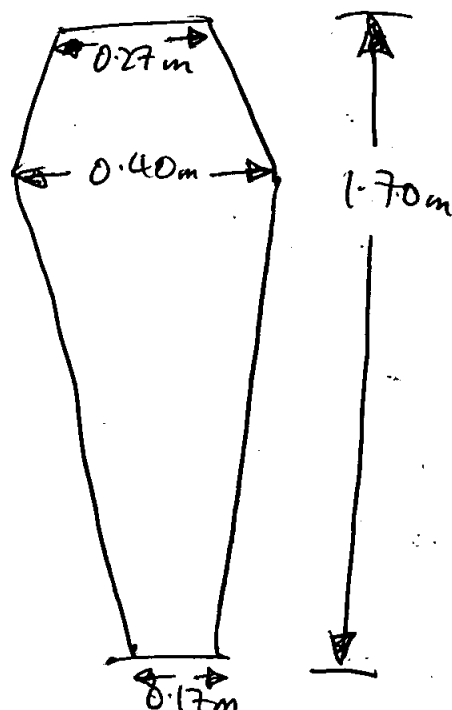

Recorder:

DP

Date:

7.11.00.

Initials:

# Coffin Recording Sheet

Site Code

Context

**Outer Coffin**

Sample Ret.

CH200

906

Recording Date ..... 13/11/00 .....

Associated Numbers .....

Condition .....

Dep. Plate

Legible

Inscription

Fabric lead  ormolou  brass  tin plated pewter  gilt tin   
 iron  silvered tin  enamelled  other ..... Sample Ret.

**Shape of dep. plate**

square  rectangle  shield  tapered  lozenge   
 cartouche  oval  other .....

**Upholstery**

colour ..... shoddy  velvet  other ..... Sample Ret.

**Construction**

butt joint  mitred  pitched  other .....

Grip plate  Fabric = ormolou  brass  tin plated pewter  gilt tin   
 iron  silvered tin  enamelled  other ..... Sample Ret.

Grip  Fabric = ormolou  brass  iron  Sample Ret.

Design swag of rose  horseshoe  cherub's head  plain   
 other ..... *small (20) ← 0.12 ↓ 0.04*

Grip bolts  Corner bolts  Type = gilt brass  brass  iron   
 other ..... Sample Ret.

Lid motifs  other .....

Escutcheons  other .....

Upholstery nails  brass  gilt brass  silvered brass  iron  enamelled   
 other ..... Sample Ret.

Fixings  panel nails  screws  hinges  lace  Sample Ret.

Timber type ..... Sample Ret.

**Interpretation / Comments**

.....  
 .....

110.

SITE	COFFIN RECORD SHEET	CONTEXT NO.
OL100		907
Trench:	Additional sheets:	Treatment:
Site sub-div: CUBA BANZ	Grave fills:	BOARDS LIFTED / BWA NO TEETH
Plan no: 7.	Grave cut:	Finds None
Section no:	Skeleton:	Breastplate Grip
Co-ordinates:	Matrix location:	Hinge Bracket
Levels:	Preservation: V. BAD BASE CORROSION OPEN AROUND 1 SIDE / SCARSING	Fixing nails Shroud pins
Slide No.:	Neg No.:	Fabric Other finds

**Description**  
Ph Coffin - Adult.  
WEST-EAST ORIENTATED.  
TRACES OF OUTER WOOD.

**Discussion**  
~~XXXXXXXXXX~~  
SANDWICH - DELETED UPPER SKULL/SKULL

**Shape, dimensions and distinguishing characteristics**

INSCRIPTION ON Ph Coffin:-  
MR  
James Phillips  
Died 24<sup>th</sup> July  
1839  
Aged 24 yr

DEPTH: 0.18m

Recorder: *DM* Date: 7.11.90. Initials:



SITE	COFFIN RECORD SHEET	CONTEXT NO.
DC100		108
Trench:	Additional sheets:	Treatment:
Site sub-div: CMT BAN 2	Grave fills:	JNA <del>NO TRENCH</del> No TRENCH.
Plan no: 7	Grave cut:	Finds
Section no:	Skeleton:	None
Co-ordinates:	Matrix location:	Breastplate
Levels	Preservation: Poor - CORRODED ON TOP / BOTTOM HOLES IN BASE	Grip ✓
Slide No.	Neg No:	Hinge
		Bracket
		Fixing nails
		Shroud pins
		Fabric
		Other finds

**Description** ~~to be added~~  
 Adult Coffin:- EAST-WEST ALIGNED. - SLIGHTLY TUMBLED BONES - MAY HAVE BEEN MOVED ABOUT?  
**Discussion** TRACES OF OUTER WOOD NAILED COFFIN.

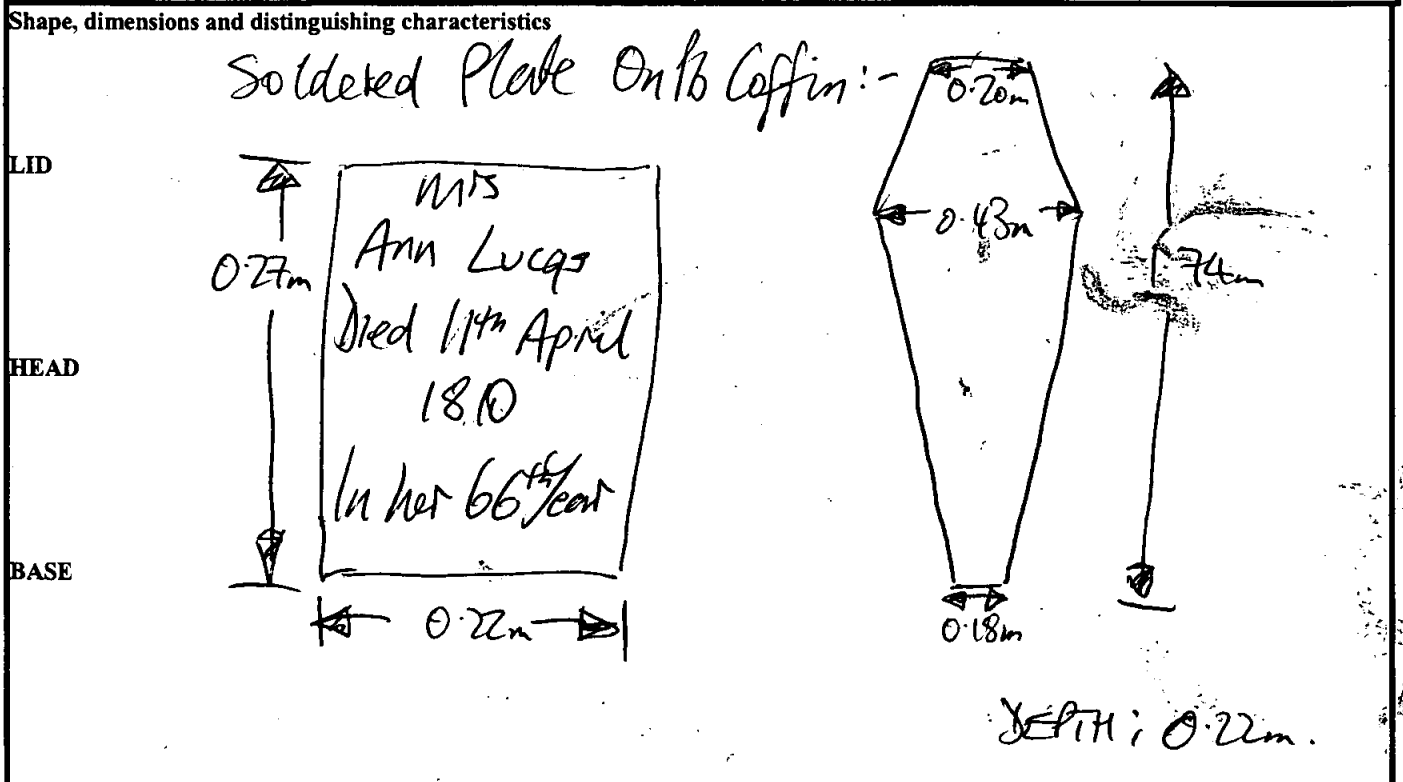

Recorder: <i>[Signature]</i>	Date: 7-11-00	Initials:
------------------------------	---------------	-----------

**Outer Coffin**

Sample Ret.

Site Code

Context

OH200

908

Recording Date ..... 20/2/01 .....

Associated Numbers .....

Condition .....

Dep. Plate

Legible

Inscription

Fabric lead  ormolou  brass  tin plated pewter  gilt tin   
 iron  silvered tin  enamelled  other ..... Sample Ret.

**Shape of dep. plate**

square  rectangle  shield  tapered  lozenge   
 cartouche  oval  other .....

**Upholstery**

colour ..... shoddy  velvet  other ..... Sample Ret.

**Construction**

butt joint  mitred  pitched  other .....

Grip plate  Fabric = ormolou  brass  tin plated pewter  gilt tin   
 iron  silvered tin  enamelled  other ..... Sample Ret.

Grip  Fabric = ormolou  brass  iron  X2 Sample Ret.

Design swag of rose  horseshoe  cherub's head  small (A)  plain   
 other .....  $\longleftrightarrow = 0.13$   $\updownarrow = 0.06$

Grip bolts  Corner bolts  Type = gilt brass  brass  iron   
 other ..... Sample Ret.

Lid motifs  other ..... Sample Ret.

Escutcheons  other ..... Sample Ret.

Upholstery nails  brass  gilt brass  silvered brass  iron  enamelled   
 other ..... Sample Ret.

Fixings  panel nails  screws  hinges  lace  Sample Ret.

Timber type ..... Sample Ret.

**Interpretation / Comments**

.....  
 .....

LD.

SITE ACD00	COFFIN RECORD SHEET	CONTEXT NO. A09
Trench:	Additional sheets: Yes x 2.	Treatment: INTACT
Site sub-div: GRAVE BAN 2	Grave fills	→ NEOLITHS
Plan no: 7	Grave cut:	Finds None
Section no:	Skeleton:	Breastplate Grip ✓
Co-ordinates:	Matrix location: —	Hinge Bracket
Levels	Preservation: GOOD - THICK LEAD NOTED AT FOOT (SMALL) SPLIT IN LID.	Fixing nails Shroud pins
Slide No.	Neg No:	Fabric Other finds

**Description** Pb Coffin - Child.  
WEST - EAST ALIGNED.  
**Discussion** TRACES OF OUTER WOOD.  
SOLDERED

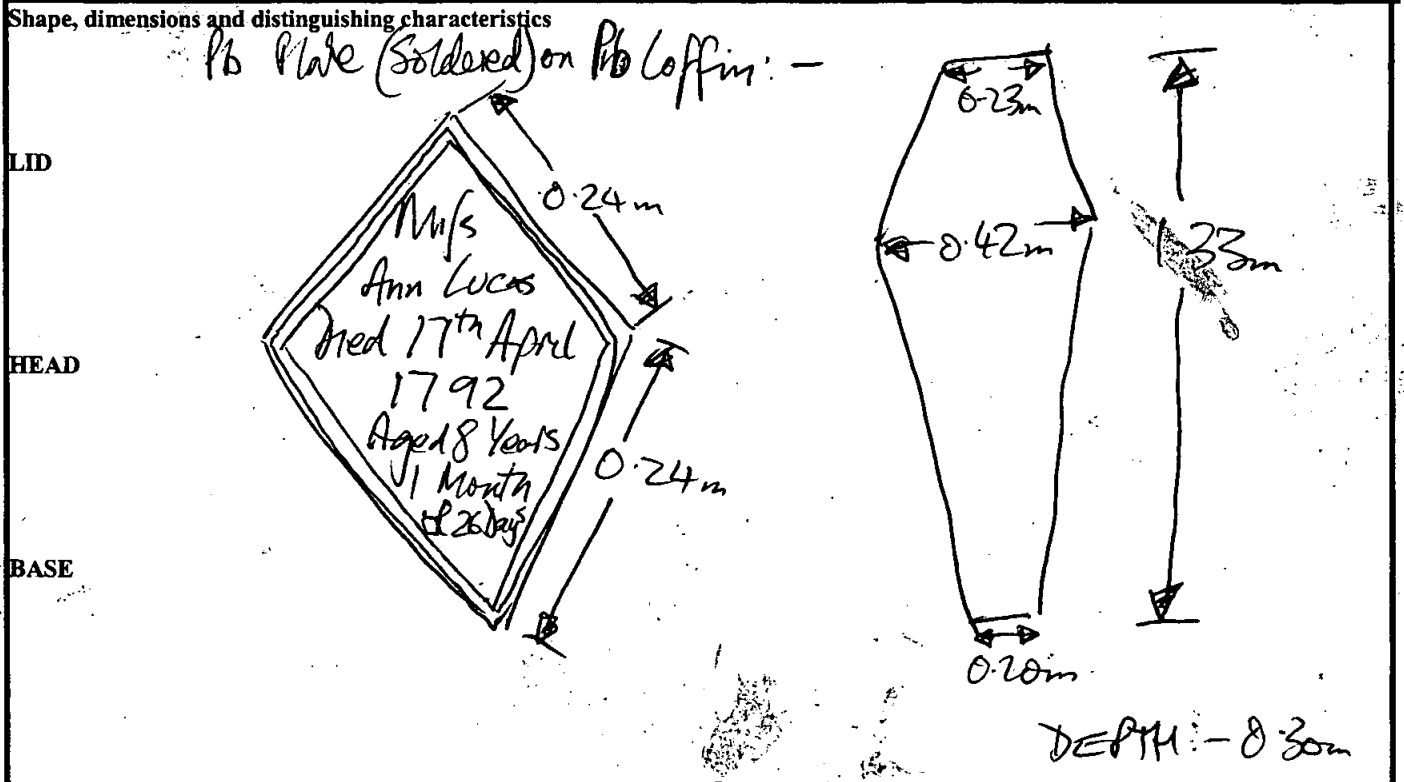

Recorder: Jaz Date: 7.11.00 Initials:

# Coffin Recording Sheet

Site Code

Context

0200

909

**Outer Coffin**

Sample Ret.

Recording Date ..... 13/11/00 .....

Associated Numbers .....

Condition .....

Dep. Plate

Legible

Inscription

Fabric lead  ormolou  brass  tin plated pewter  gilt tin   
 iron  silvered tin  enamelled  other ..... Sample Ret.

**Shape of dep. plate**

square  rectangle  shield  tapered  lozenge   
 cartouche  oval  other .....

**Upholstery**

colour ..... shoddy  velvet  other ..... Sample Ret.

**Construction**

butt joint  mitred  pitched  other .....

**Grip plate**  Fabric = ormolou  brass  tin plated pewter  gilt tin   
 iron  silvered tin  enamelled  other *pb new* ..... Sample Ret.

**Grip**  Fabric = ormolou  brass  iron  *x3 Sptfeds 6* Sample Ret.

**Design** swag of rose  horseshoe  cherub's head  plain   
 other .....

**Grip bolts**  **Corner bolts**  **Type =** gilt brass  brass  iron   
 other ..... Sample Ret.

**Lid motifs**  other ..... Sample Ret.

**Escutcheons**  other ..... Sample Ret.

**Upholstery nails**  brass  gilt brass  silvered brass  iron  enamelled   
 other ..... Sample Ret.

**Fixings**  panel nails  screws  hinges  lace  Sample Ret.

**Timber type** ..... Sample Ret.

**Interpretation / Comments**

.....  
 .....

hb

SITE 02100	COFFIN RECORD SHEET	CONTEXT NO. 910
Trench:	Additional sheets: YES x 2	Treatment: DATA/bones
Site sub-div: CHURCH BAY 2	Grave fills	
Plan no: 7	Grave cut:	Finds None
Section no:	Skeleton:	Breastplate X Grip
Co-ordinates:	Matrix location:	Hinge Bracket
Levels	Preservation: Corroded AT BASE/HEAD	Fixing nails Shroud pins
Slide No.:	Neg No:	Fabric Other finds

Description Pb Adult Coffin  
EAST-WEST ALIGNED  
SOLDERED

Discussion TRACES OF OUTER WOOD COFFIN

Shape, dimensions and distinguishing characteristics

INSCRIPTION: -  
MR  
William Roanve <sup>2-W?</sup>  
Died 5<sup>th</sup> April  
1784  
Aged 59 Years.

LID

HEAD

BASE

DEPTH: 0.32m

Recorder: <i>DM</i>	Date: 7.11.00	Initials:
---------------------	---------------	-----------

Site Code

Context

**Outer Coffin**

Sample Ret.

OKR00

910

Recording Date ..... 16/10/00

Associated Numbers .....

Condition ..... ↑

*Inscription*  
~~Dep. Plate~~

Legible

Inscription "Mr/William Rowe <sup>bordered</sup> / Died 5<sup>th</sup> April 1784 / Aged 59 Years"  
ROWE

Fabric lead  ormolou  brass  tin plated pewter  gilt tin   
 iron  silvered tin  enamelled  other ..... Sample Ret.

Shape of ~~dep. plate~~ <sup>*inscript.*</sup>  
 square  rectangle  shield  tapered  lozenge   
 cartouche  oval  other .....

Upholstery   
 colour ..... shoddy  velvet  other ..... Sample Ret.

Construction butt joint  mitred  pitched  other .....

Grip plate  Fabric = ormolou  brass  tin plated pewter  gilt tin   
 iron  silvered tin  enamelled  other ..... Sample Ret.

Grip  Fabric = ormolou  brass  iron  Sample Ret.

Design swag of rose  horseshoe  cherub's head  plain   
 other .....

Grip bolts  Corner bolts  Type = gilt brass  brass  iron   
 other ..... Sample Ret.

Lid motifs  other ..... Sample Ret.

Escutcheons  other ..... Sample Ret.

Upholstery nails  brass  gilt brass  silvered brass  iron  enamelled   
 other ..... Sample Ret.

Fixings  panel nails  screws  hinges  lace  Sample Ret.

Timber type ..... Sample Ret.

Interpretation / Comments

.....  
 .....

07200

910

Cont.

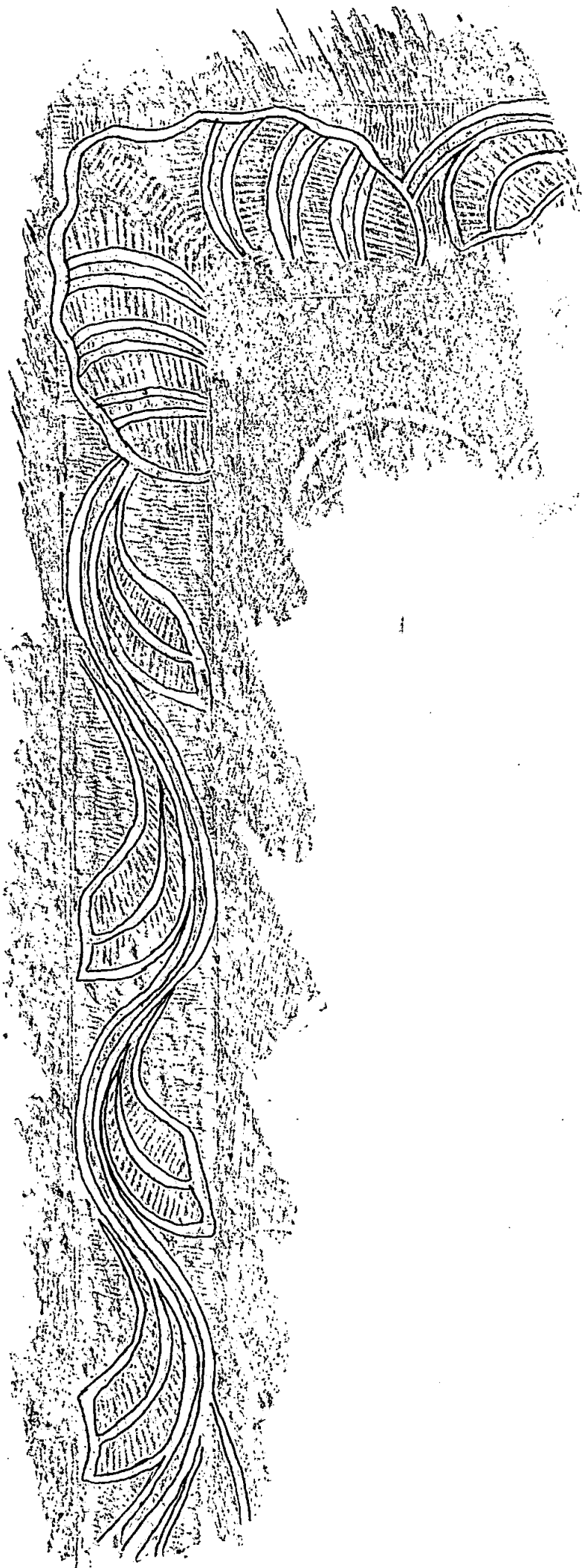

db.

SITE	COFFIN RECORD SHEET	CONTEXT NO.
02 R00.		911
Trench:	Additional sheets: YES X1.	Treatment: INTER-NECROP.
Site sub-div: CRUIT RAY 2.	Grave fills	
Plan no: 7	Grave cut:	Finds None
Section no:	Skeleton:	Breastplate Grip ✓
Co-ordinates:	Matrix location:	Hinge Bracket
Levels	Preservation: BAD CORROSION AT TOP OF FEET + VARIOUS PATCHES.	Fixing nails Shroud pins
Slide No.	Neg No:	Fabric Other finds

**Description** PB ADULT COFFIN WEST-EAST ALIGNED. TRACES OF OUTER WOOD SOLDERED.

**Discussion**

Shape, dimensions and distinguishing characteristics  
Inscribed Plaque on Coffin:-

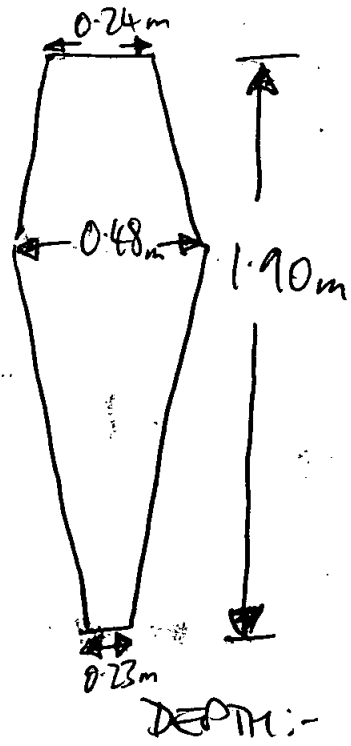
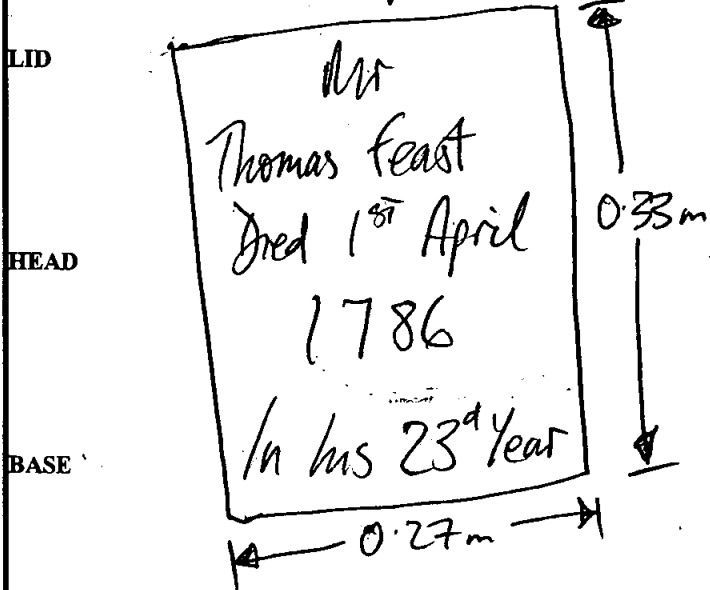

Recorder: PA	Date: 8.11.00.	Initials:
--------------	----------------	-----------



# Coffin Recording Sheet

**Outer Coffin**

Sample Ret.

Site Code

Context

02200

911

Recording Date ..... 17/11/00 .....

Associated Numbers .....

Condition .....

Dep. Plate

Legible

Inscription

Fabric lead  ormolou  brass  tin plated pewter  gilt tin   
 iron  silvered tin  enamelled  other ..... Sample Ret.

**Shape of dep. plate**

square  rectangle  shield  tapered  lozenge   
 cartouche  oval  other .....

**Upholstery**

colour ..... shoddy  velvet  other ..... Sample Ret.

**Construction**

butt joint  mitred  pitched  other .....

Grip plate  Fabric = ormolou  brass  tin plated pewter  gilt tin   
 iron  silvered tin  enamelled  other ..... Sample Ret.

Grip  Fabric = ormolou  brass  iron  x1 Sample Ret.

Design swag of rose  horseshoe  cherub's head  plain   
 other ..... too conc. to id.

Grip bolts  Corner bolts  Type = gilt brass  brass  iron   
 other ..... Sample Ret.

Lid motifs  other ..... Sample Ret.

Escutcheons  other ..... Sample Ret.

Upholstery nails  brass  gilt brass  silvered brass  iron  enamelled   
 other ..... Sample Ret.

Fixings  panel nails  screws  hinges  lace  Sample Ret.

Timber type ..... Sample Ret.

**Interpretation / Comments**

.....  
 .....

db

SITE 02200	COFFIN RECORD SHEET	CONTEXT NO. 912
Trench:	Additional sheets: YES X 1	Treatment: INTACT - NECRSP.
Site sub-div: CAMP BAR 2	Grave fills	
Plan no: 7.	Grave cut:	Findings None
Section no:	Skeleton:	Breastplate <input checked="" type="checkbox"/> Grip
Co-ordinates:	Matrix location:	Hinge Bracket
Levels	Preservation: SQUASHED BUT INTACT.	Fixing nails Shroud pins
Slide No.	Neg No:	Fabric Other finds

**Description** Pb ADULT COFFIN  
WEST-EAST ALIGNED.  
TRACES OF OUTER WOOD.  
SOLDERED.

**Discussion** Pb Plaque on Coffin leads:-  
Mr  
Rich<sup>d</sup> Cha<sup>s</sup> Davis  
Died [Jan] 9  
1877  
In his 47<sup>th</sup> Year

Shape, dimensions and distinguishing characteristics

INSCRIPTION ON COFFIN:-

LID  
Mr  
Rich<sup>d</sup> Cha<sup>s</sup> Davis  
Died [Jan] 9  
1877  
In his 47<sup>th</sup> Year.

HEAD (Hole)

BASE

Diagram of a coffin lid showing dimensions: top width 0.28m, middle width 0.48m, bottom width 0.24m, and height 2.00m.

DEPTH:- 0.3m

Recorder: DB	Date: 8.11.00.	Initials:
-----------------	-------------------	-----------

Site Code

Context

**Outer Coffin**

Sample Ret.

Oh200

912

Recording Date ..... 16/11/00 .....

Associated Numbers .....

Condition ..... 2 .....

Dep. Plate

Legible

Inscription "Mr/Rich<sup>d</sup> Chas<sup>s</sup> Davis/Died 1<sup>st</sup> Jan<sup>y</sup>/1817/In his 47<sup>th</sup> Year"

Fabric lead  ormolou  brass  tin plated pewter  gilt tin   
 iron  silvered tin  enamelled  other ..... Sample Ret.

⑧ w/ new outer border sheet.

**Shape of dep. plate**

square  rectangle  shield  tapered  lozenge   
 cartouche  oval  other .....

**Upholstery**

colour ..... shoddy  velvet  other ..... Sample Ret.

**Construction**

butt joint  mitred  pitched  other .....

**Grip plate**  Fabric = ormolou  brass  tin plated pewter  gilt tin   
 iron  silvered tin  enamelled  other ..... Sample Ret.

**Grip**  Fabric = ormolou  brass  iron  Sample Ret.

**Design** swag of rose  horseshoe  cherub's head  plain   
 other .....

**Grip bolts**  **Corner bolts**  Type = gilt brass  brass  iron   
 other ..... Sample Ret.

**Lid motifs**  other ..... Sample Ret.

**Escutcheons**  other ..... Sample Ret.

**Upholstery nails**  brass  gilt brass  silvered brass  iron  enamelled   
 other ..... Sample Ret.

**Fixings**  panel nails  screws  hinges  lace  Sample Ret.

**Timber type** ..... Sample Ret.

**Interpretation / Comments**

.....  
 .....

db

SITE		COFFIN RECORD SHEET		CONTEXT NO.	
02100		Additional sheets: YES x1		113	
Trench:		Grave fills		Treatment: INSCR → NECROP.	
Site sub-div: CRUFT BAN 2		Grave cut:		Finds	
Plan no: 7.		Skeleton:		None	
Section no:		Matrix location: —		Breastplate	
Co-ordinates:		Preservation: SQUASHED BUT MANY GOOD - V. LITTLE CORROSION VISIBLE.		Grip ✓	
Levels		Slide No.		Hinge	
Slide No.		Neg No:		Bracket	
				Fixing nails	
				Shroud pins	
				Fabric	
				Other finds	

**Description** Pb ADULT COFFIN  
WEST-EAST ALIGNED.

**Discussion**

**Shape, dimensions and distinguishing characteristics**

INSCRIPTION ON COFFIN:-  
(V. SIMILAR BORDER THAS ON (909))

LID

HEAD

BASE

Mr  
Thomas Godman  
Died 30<sup>th</sup> Aug<sup>st</sup>  
1784  
Aged 85 Years.

DEPTH:- 0.28m

Recorder: JM	Date: 8.11.00	Initials:
--------------	---------------	-----------

Site Code

Context

**Outer Coffin**

Sample Ret.

OLR00

913

Recording Date ..... 17/11/00 .....

Associated Numbers .....

Condition .....

Dep. Plate

Legible

Inscription

Fabric lead  ormolou  brass  tin plated pewter  gilt tin   
 iron  silvered tin  enamelled  other ..... Sample Ret.

**Shape of dep. plate**

square  rectangle  shield  tapered  lozenge   
 cartouche  oval  other .....

**Upholstery**

colour ..... shoddy  velvet  other ..... Sample Ret.

**Construction**

butt joint  mitred  pitched  other .....

Grip plate  Fabric = ormolou  brass  tin plated pewter  gilt tin   
 iron  silvered tin  enamelled  other ..... Sample Ret.

Grip  Fabric = ormolou  brass  iron  X2 Sample Ret.

Design swag of rose  horseshoe  cherub's head  ① plain   
 other .....

Grip bolts  Corner bolts  Type = gilt brass  brass  iron   
 other ..... Sample Ret.

Lid motifs  other ..... Sample Ret.

Escutcheons  other ..... Sample Ret.

Upholstery nails  brass  gilt brass  silvered brass  iron  enamelled   
 other ..... Sample Ret.

Fixings  panel nails  screws  hinges  lace  Sample Ret.

Timber type ..... Sample Ret.

**Interpretation / Comments**

.....  
 .....

db.

SITE OLKOO	COFFIN RECORD SHEET	CONTEXT NO. <del>9113</del> 9114
Trench:	Additional sheets:	Treatment: <del>INTER</del> NECROPOLIS
Site sub-div: CAMP BAY 2	Grave fills	
Plan no: 7.	Grave cut:	Finds None ✓
Section no:	Skeleton:	Breastplate Grip
Co-ordinates:	Matrix location:	Hinge Bracket
Levels	Preservation: <del>OD</del> SPOTS OF CORROSION ESP. AT LOWER SIDES - & THO. TOP GASHED DOWN SIDE OF INSERIP	Fixing nails Shroud pins
Slide No.	Neg No:	Fabric Other finds

**Description** Pb ADULT COFFIN  
EAST-WEST ALIGNED.  
SOLDERED.  
TRACES OF OUTER WOOD COFFIN

**Discussion**

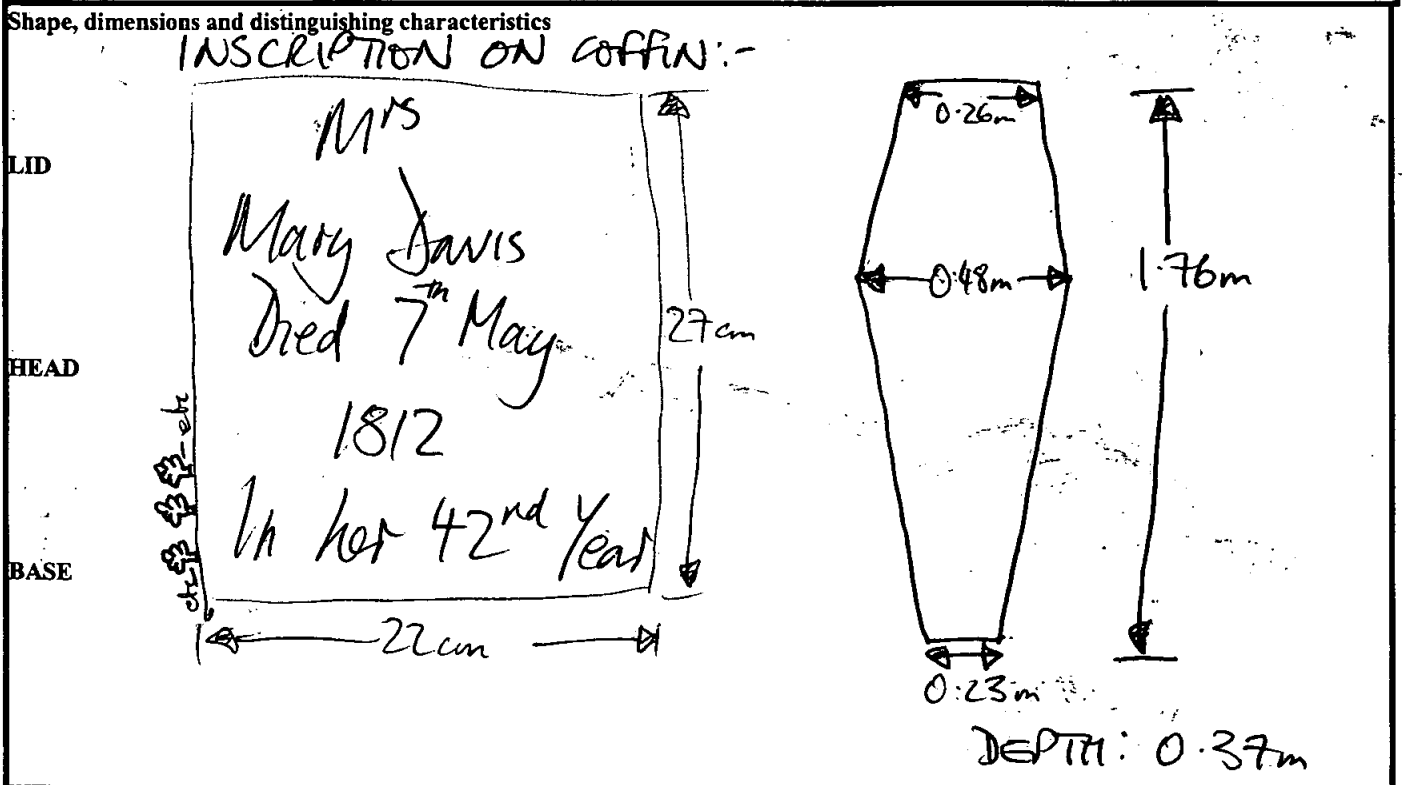

Recorder: *PM* Date: 8.11.00. Initials:

db

SITE 02100.	COFFIN RECORD SHEET	CONTEXT NO. 915
Trench:	Additional sheets:	Treatment: bones concealed.
Site sub-div: CHURCH BAY 2	Grave fills:	
Plan no: 7.	Grave cut:	Finds None ✓
Section no:	Skeleton:	Breastplate Grip
Co-ordinates:	Matrix location: (915)	Hinge Bracket
Levels:	Preservation: COFFIN SPLIT AT FOOT + UPPER SIDE - CORRODED + SQUASHED.	Fixing nails Shroud pins
Slide No.:	Neg No.:	Fabric <del>888</del> COFFIN LINER. Other finds

Description  
PB COFFIN ADULT  
WEST-EAST ALIGNED.  
TRACES OF OUTER WOOD  
SOLDERED.

Discussion  
BRANNED.

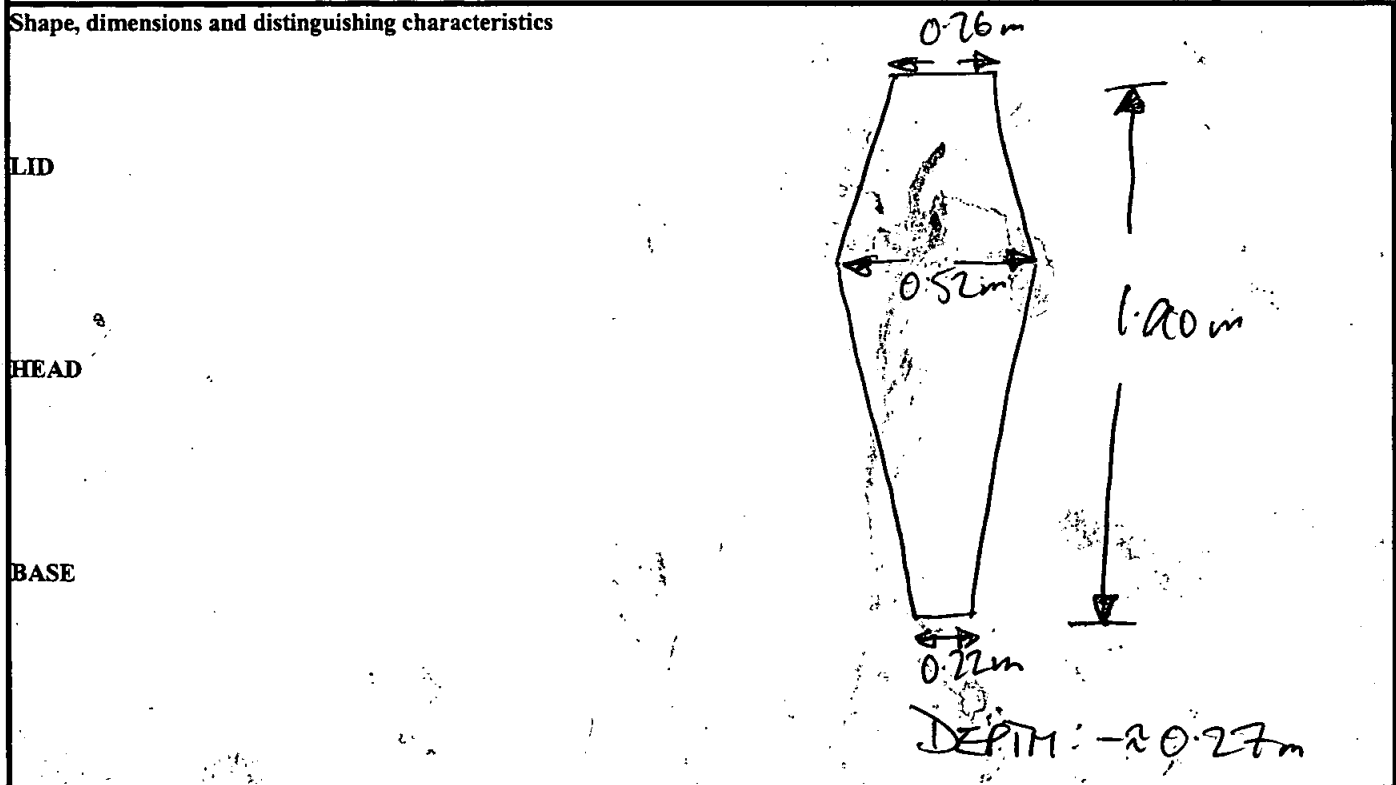

Recorder: DM	Date: 9.11.00	Initials:
-----------------	------------------	-----------

db.

SITE 02100	COFFIN RECORD SHEET	CONTEXT NO. 916
Trench:	Additional sheets: YES x 1	Treatment: DNA/Bones
Site sub-div: COURT BAN 2.	Grave fills	
Plan no: 7.	Grave cut:	Finds None
Section no:	Skeleton:	Breastplate ✓ Grip
Co-ordinates:	Matrix location: 916	Hinge Bracket
Levels	Preservation: V. BADLY DECAYED / SPLIT AT HEAD - SQUASHED.	Fixing nails Shroud pins
Slide No.	Neg No:	Fabric Other finds

Description Pb ADULT COFFIN NAILED. EAST-WEST ASKED. OUTER WOOD

Pb Soldered Plate on Coffin: -

Sus<sup>a</sup> Stanley  
Died 23<sup>rd</sup> Jan<sup>y</sup>  
1813  
Aged 44 Yrs

Discussion

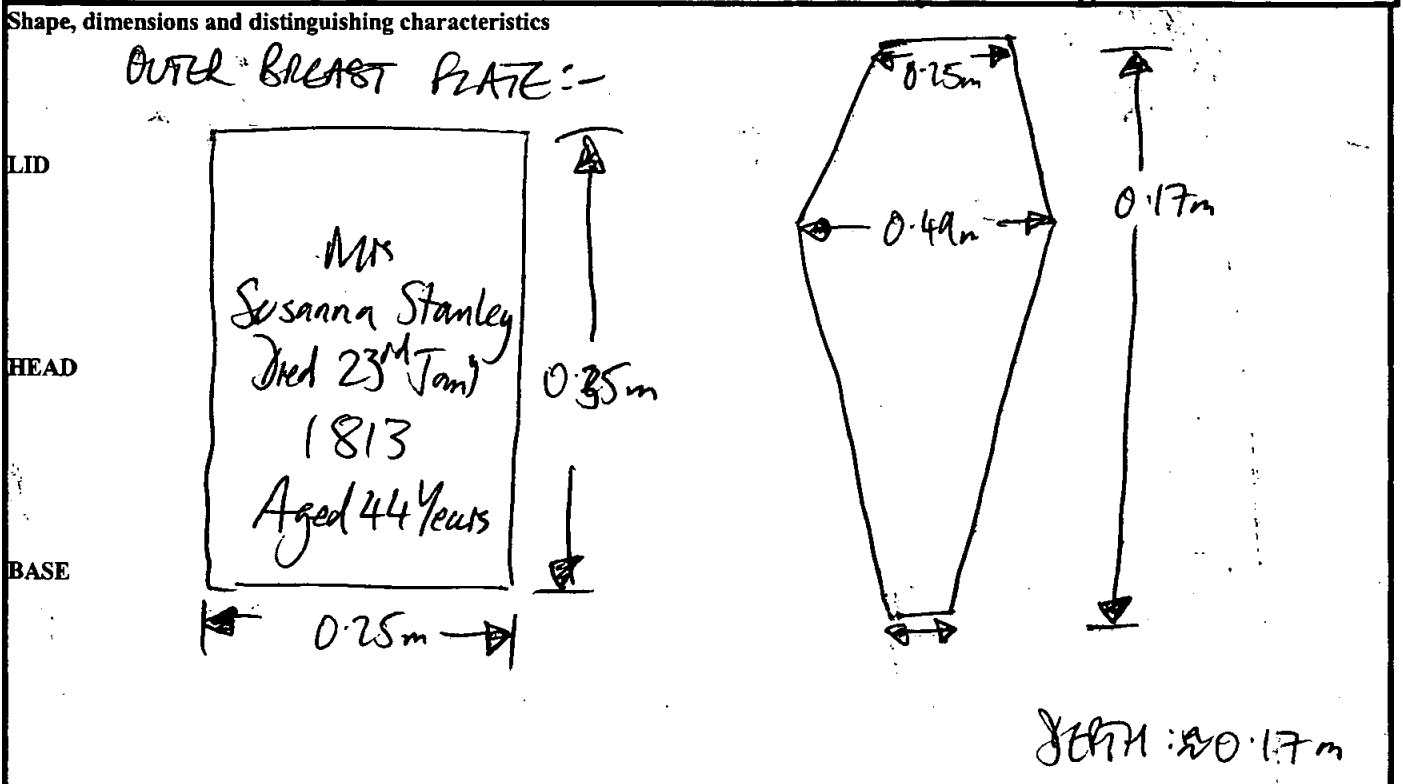

Recorder: M	Date: 9.11.00.	Initials:
----------------	-------------------	-----------



**Outer Coffin**

Sample Ret.

Site Code

Context

OR00

916

Recording Date ..... 16/11/00 .....

Associated Numbers .....

Condition ..... 3 .....

Dep. Plate

Legible

Inscription "Mrs/Susanna Stanley/Died 23<sup>rd</sup> Jan<sup>y</sup>/1813/ Aged 44 Years"  
same as 362. ~~the lid~~ bottom beyond.

Fabric lead  ormolou  brass  tin plated pewter  gilt tin   
iron  silvered tin  enamelled  other ..... Sample Ret.

**Shape of dep. plate**

square  rectangle  shield  tapered  lozenge   
cartouche  oval  other .....

**Upholstery**

colour ..... shoddy  velvet  other ..... Sample Ret.

**Construction**

butt joint  mitred  pitched  other .....

Grip plate  Fabric = ormolou  brass  tin plated pewter  gilt tin   
iron  silvered tin  enamelled  other ..... Sample Ret.

Grip  Fabric = ormolou  brass  iron  Sample Ret.

Design swag of rose  horseshoe  cherub's head  plain

other .....

Grip bolts  Corner bolts  Type = gilt brass  brass  iron

other ..... Sample Ret.

Lid motifs  other ..... Sample Ret.

Escutcheons  other ..... Sample Ret.

Upholstery nails  brass  gilt brass  silvered brass  iron  enamelled

other ..... Sample Ret.

Fixings  panel nails  screws  hinges  lace  Sample Ret.

Timber type ..... Sample Ret.

**Interpretation / Comments**

.....  
.....

# Coffin Recording Sheet

Site Code

Context

**Outer Coffin**

Sample Ret.

**Oh200**

**916**

Recording Date ..... **15/2/01** .....

Associated Numbers .....

Condition .....

Dep. Plate

Legible

Inscription

**Fabric** lead  ormolou  brass  tin plated pewter  gilt tin   
 iron  silvered tin  enamelled  other ..... Sample Ret.

**Shape of dep. plate**

square  rectangle  shield  tapered  lozenge   
 cartouche  oval  other .....

**Upholstery**

colour ..... shoddy  velvet  other ..... Sample Ret.

**Construction**

butt joint  mitred  pitched  other .....

**Grip plate**

**Fabric** = ormolou  brass  tin plated pewter  gilt tin   
 iron  silvered tin  enamelled  other ..... Sample Ret.

*frags on rev of grip - unid.*

**Grip**

**Fabric** = ormolou  brass  iron  Sample Ret.

**X1**  
**(4)**

**Design**

swag of rose  horseshoe  cherub's head  plain

other .....

**Grip bolts**

**Corner bolts**  **Type =** gilt brass  brass  iron

other ..... Sample Ret.

**Lid motifs**

other ..... Sample Ret.

**Escutcheons**

other ..... Sample Ret.

**Upholstery nails**

brass  gilt brass  silvered brass  iron  enamelled

other ..... Sample Ret.

**Fixings**

panel nails  screws  hinges  lace  Sample Ret.

**Timber type** .....

Sample Ret.

**Interpretation / Comments**

.....  
 .....

db

SITE	COFFIN RECORD SHEET	CONTEXT NO.
02/100		917
Trench:	Additional sheets: 465x1	Treatment: INTACT → NECROPOLIS
Site sub-div: CANT BAY 2	Grave fills	
Plan no: 7.	Grave cut:	Findings: None
Section no:	Skeleton:	Breastplate ✓ + FOOTPLATE.
Co-ordinates:	Matrix location: (OUT)	Grip
Levels	Preservation: Fairly poor - SPLIT AT HEAD + FOOT / CORRODED. SQUASHED.	Hinge
Slide No.	Neg No:	Bracket
		Fixing nails
		Shroud pins
		Fabric
		Other finds

Description Pb ADULT COFFIN - SOLDERED. WEST - EAST ORIENTATED. OUTER WOOD TRACES

Pb FOOTPLATE (NAMED):-

Discussion

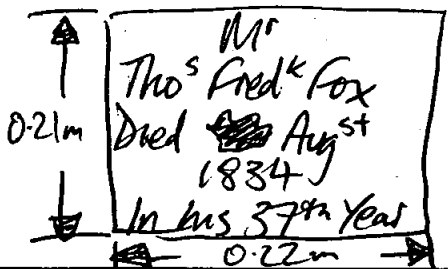

Shape, dimensions and distinguishing characteristics

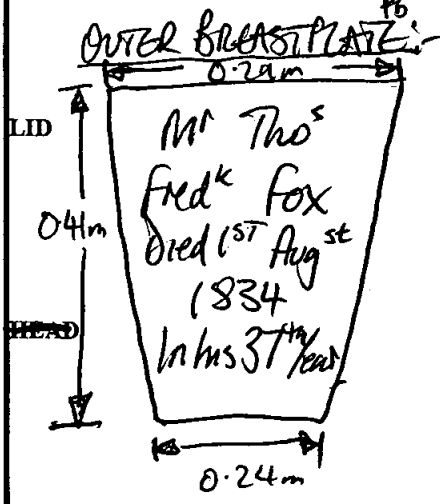

INSCRIPTION:-  
Mr Tho's Fredk Fox  
Died 1st August  
1834  
In his 37th Year

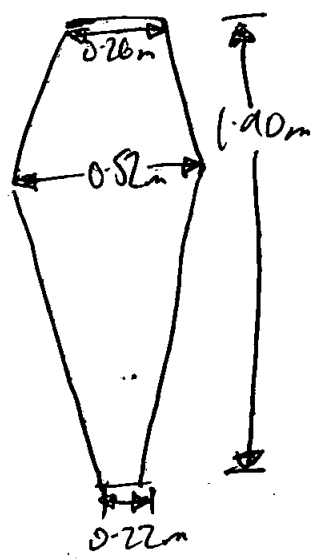

Recorder: TM	Date: 9.11.00.	Initials:
--------------	----------------	-----------

# Coffin Recording Sheet

Site Code

Context

**Outer Coffin**

Sample Ret.

0200

917

Recording Date ..... 16/11/00 .....

Associated Numbers .....

Condition ..... 3 .....

Dep. Plate

Legible

Inscription "Mr Tho<sup>s</sup>/Fred<sup>k</sup> Fox/Died 1<sup>st</sup> Aug<sup>st</sup>/1834/In his 57<sup>th</sup> year"

Fabric lead  ormolou  brass  tin plated pewter  gilt tin   
iron  silvered tin  enamelled  other ..... Sample Ret.

(21) w/ 534 outer border.

**Shape of dep. plate**

square  rectangle  shield  tapered  lozenge   
cartouche  oval  other .....

**Upholstery**

colour ..... shoddy  velvet  other ..... Sample Ret.

**Construction**

butt joint  mitred  pitched  other .....

Grip plate  Fabric = ormolou  brass  tin plated pewter  gilt tin   
iron  silvered tin  enamelled  other ..... Sample Ret.

Grip  Fabric = ormolou  brass  iron  Sample Ret.

Design swag of rose  horseshoe  cherub's head  plain   
other .....

Grip bolts  Corner bolts  Type = gilt brass  brass  iron   
other ..... Sample Ret.

Lid motifs  other ..... Sample Ret.

Escutcheons  other ..... Sample Ret.

Upholstery nails  brass  gilt brass  silvered brass  iron  enamelled   
other ..... Sample Ret.

Fixings  panel nails  screws  hinges  lace  Sample Ret.

Timber type ..... Sample Ret.

**Interpretation / Comments**

.....  
.....

db.

SITE 02100.	COFFIN RECORD SHEET	CONTEXT NO. 018
Trench:	Additional sheets:	Treatment: INTACT → NEOLITHIC.
Site sub-div: Celtic BANZ	Grave fills:	
Plan no.: 7.	Grave cut:	Finds None ✓
Section no:	Skeleton:	Breastplate Grip
Co-ordinates:	Matrix location: 018	Hinge Bracket
Levels:	Preservation: CORRODED IN PLATES - TOP/SIDE.	Fixing nails Shroud pins
Slide No.:	Neg No.:	Fabric Other finds

Description

Discussion

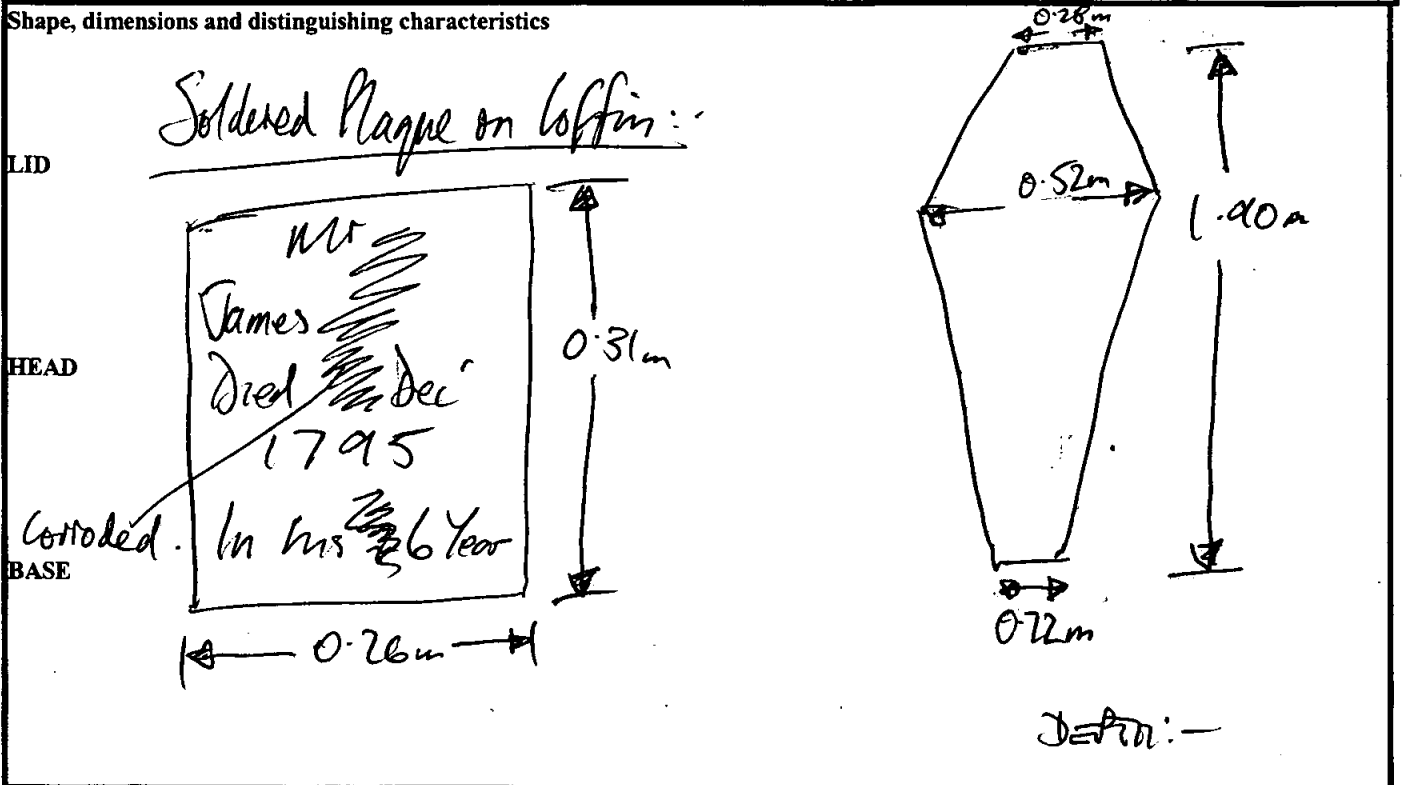

Recorder: DM	Date: 9.11.00.	Initials:
-----------------	-------------------	-----------

db.

SITE <i>02/06</i>	COFFIN RECORD SHEET	CONTEXT NO. <i>919</i>
Trench: <i>CRYPT</i>	Additional sheets:	Treatment: <i>INTACT</i> <i>NO NAME ⇒ NECR.</i>
Site sub-div:	Grave fills	Finds
Plan no: <i>7</i>	Grave cut:	None <input checked="" type="checkbox"/>
Section no:	Skeleton:	Breastplate
Co-ordinates:	Matrix location: <del><i>961</i></del> <i>v/l 961</i>	Grip
Levels	Preservation: <i>A</i>	Hinge
Slide No.	Neg No:	Bracket
		Fixing nails
		Shroud pins
		Fabric
		Other finds

Description *adult p. b. coffin.*

Discussion *W → E*

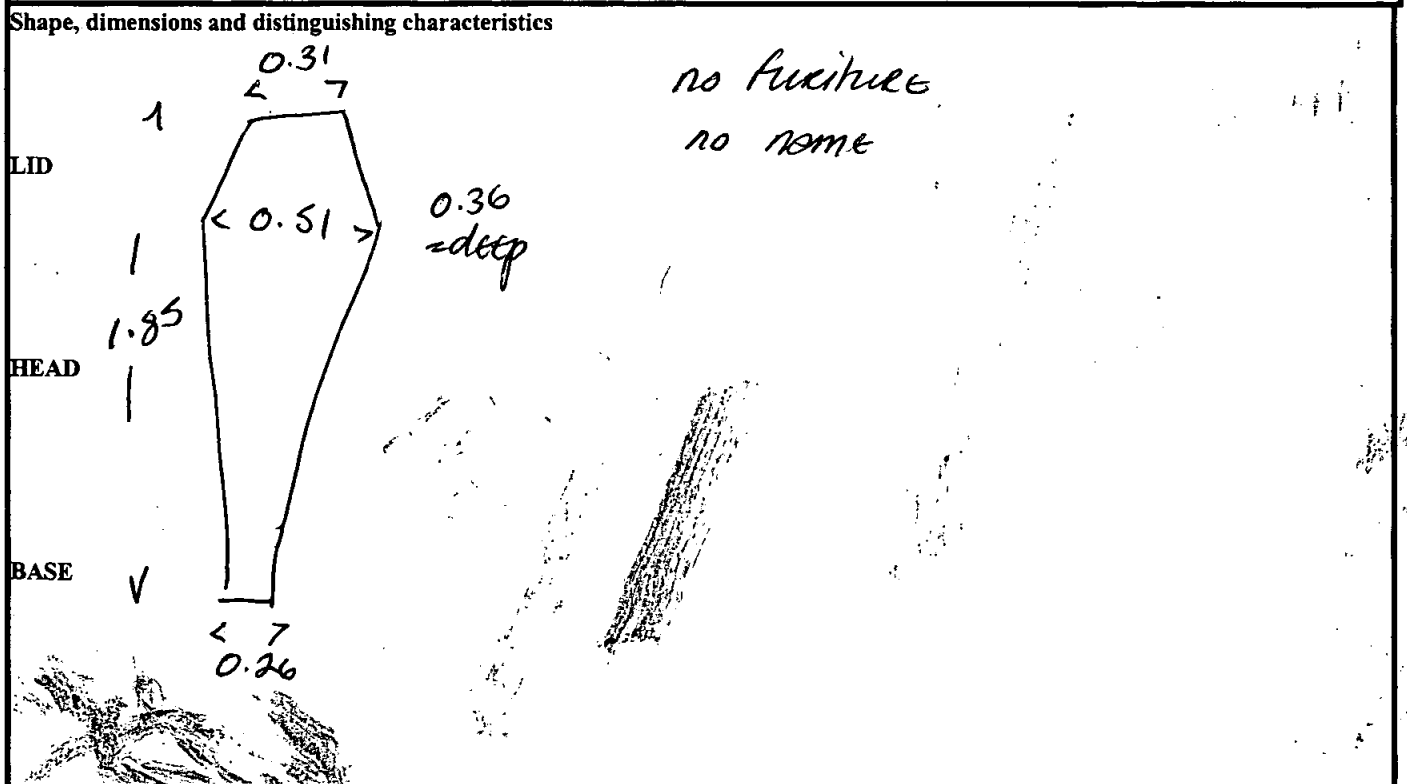

Recorder:	Date:	Initials:
-----------	-------	-----------

db.

SITE		COFFIN RECORD SHEET	CONTEXT NO.
Trench:	04R00 CRYPT	Additional sheets: YES x1	Treatment: BONES LIFTED
Site sub-div:	Bay 3	Grave fills	u DNA TAKEN NO TEETH.
Plan no:	7	Grave cut:	Finds None + mod plate (B) inscrip - top plain (C) Breastplate
Section no:		Skeleton:	Grip plate Fe. + 1 x grip (partial) (C) shield
Co-ordinates:		Matrix location: adj to 919	Hinge which matches plate. Bracket (SEE OVER)
Levels		Preservation: 1.	Fixing nails
Slide No.		Neg No:	Shroud pins
			Fabric
			Other finds

Description: adult p.b. coffin  
MRS

Discussion: W → E

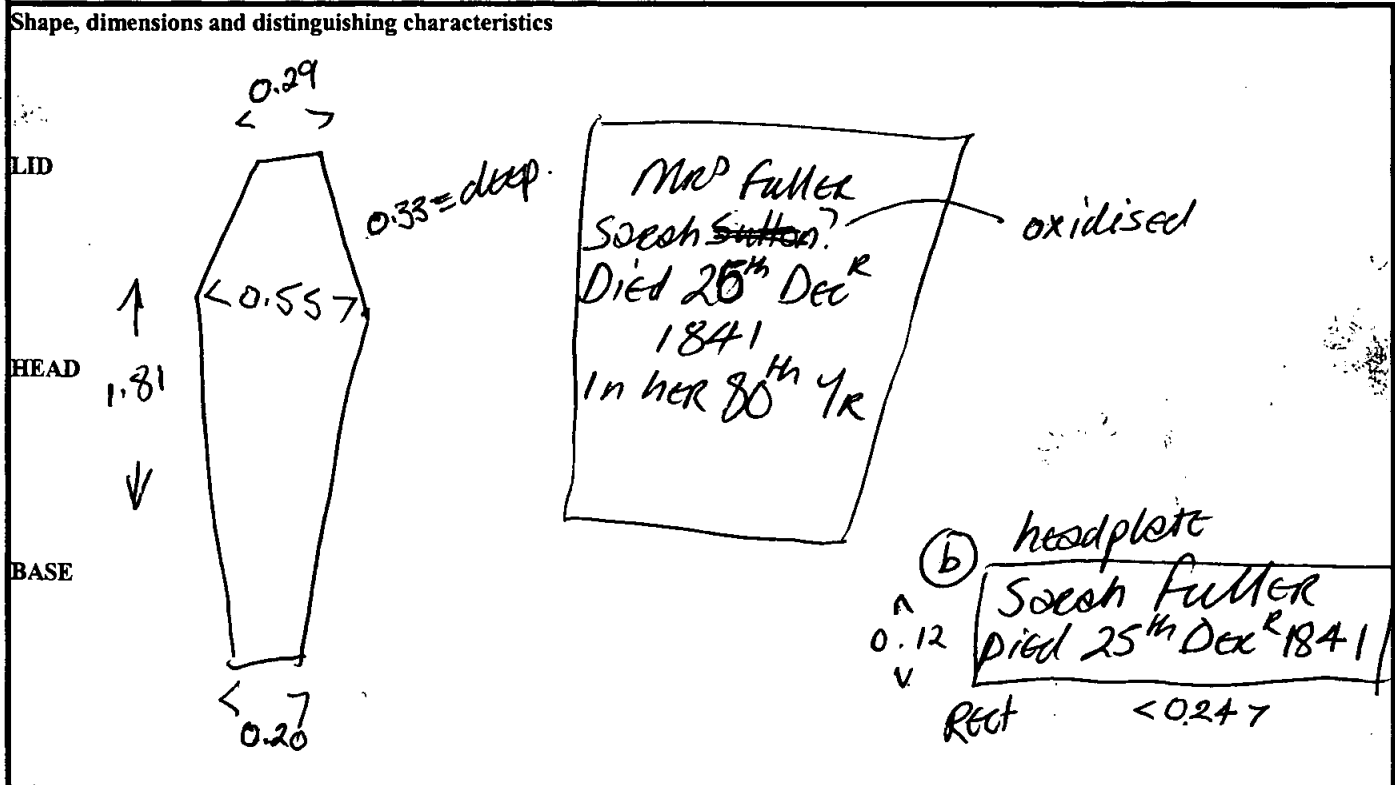

Recorder: Mel Date: 14.11.00 Initials:

Site Code

Context

**Outer Coffin**

Sample Ret.

Recording Date ..... *15/11/00* .....

Associated Numbers .....

Condition .....

Dep. Plate

Legible

Inscription

Fabric lead  ormolou  brass  tin plated pewter  gilt tin   
 iron  silvered tin  enamelled  other ..... Sample Ret.

**Shape of dep. plate**

square  rectangle  shield  tapered  lozenge   
 cartouche  oval  other .....

**Upholstery**

colour ..... shoddy  velvet  other ..... Sample Ret.

**Construction**

butt joint  mitred  pitched  other .....

**Grip plate**  Fabric = ormolou  brass  tin plated pewter  gilt tin

iron  silvered tin  enamelled  other ..... Sample Ret.

*frag of (23)*

**Grip**  Fabric = ormolou  brass  iron  Sample Ret.

**Design** swag of rose  horseshoe  cherub's head  plain

other .....

**Grip bolts**  **Corner bolts**  **Type =** gilt brass  brass  iron

other ..... Sample Ret.

**Lid motifs**  other ..... Sample Ret.

**Escutcheons**  other *frag of (11)* ..... Sample Ret.

**Upholstery nails**  brass  gilt brass  silvered brass  iron  enamelled

other ..... Sample Ret.

**Fixings**  panel nails  screws  hinges  lace  Sample Ret.

**Timber type** ..... Sample Ret.

**Interpretation / Comments**

.....  
 .....



db.

SITE OLR 00	COFFIN RECORD SHEET	CONTEXT NO. 921
Trench: CRYPT	Additional sheets:	Treatment: BONES TAKEN WHERE POSS. - NO DNA - NO LIFTABLE SKULL
Site sub-div: Bay 3	Grave fills	
Plan no: 7	Grave cut:	Finds None insep. Rect
Section no:	Skeleton:	Breastplate Grip
Co-ordinates:	Matrix location: Bay 3 adj to 922	Hinge Bracket
Levels	Preservation:	Fixing nails Shroud pins
Slide No.	Neg No:	Fabric Other finds

**Description**  
adult p.b. coffin. body brenned - v. poor cond. barely liftable.

**Discussion**  
W → E

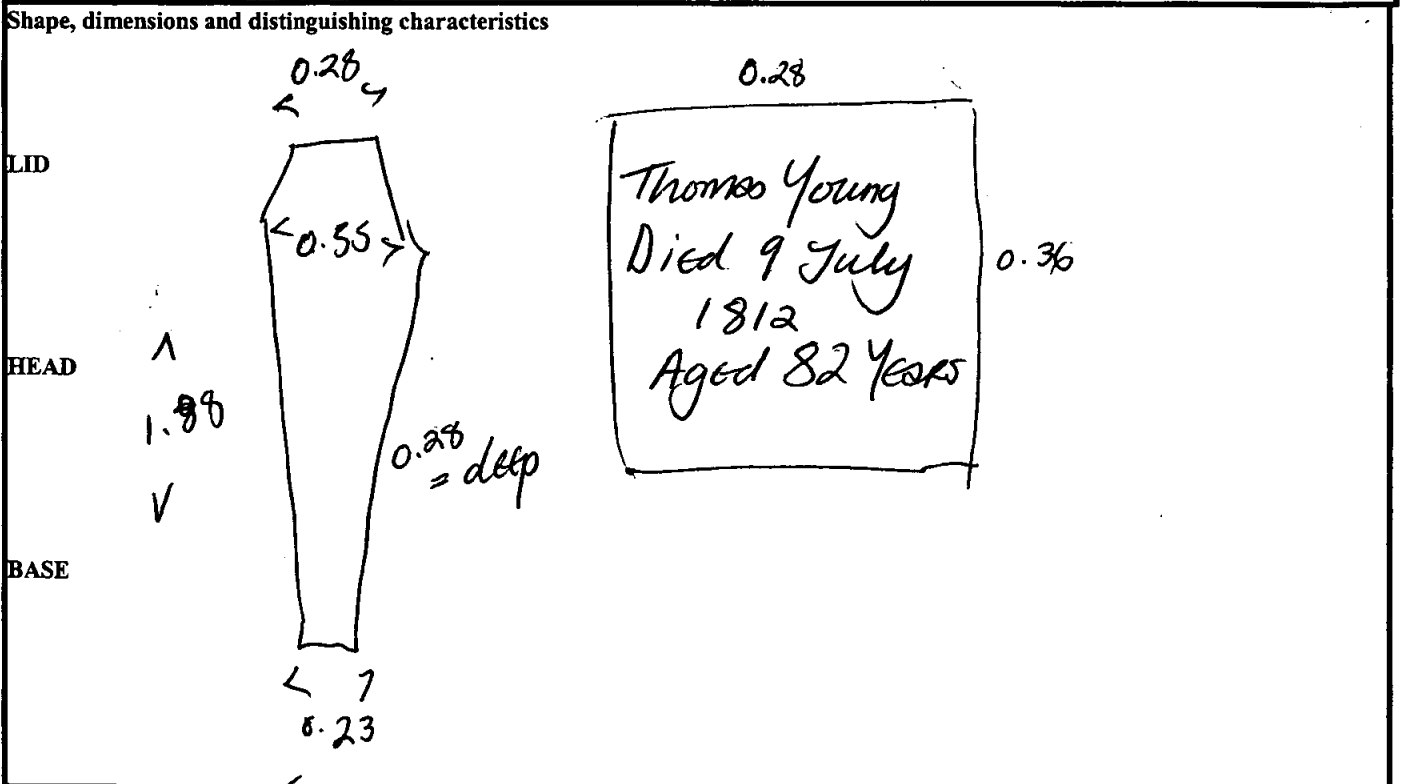

Recorder: P3 / M Date: 14-11-80 Initials:

db.

SITE 02L00	COFFIN RECORD SHEET	CONTEXT NO. 922 BONES
Trench: CRYPT	Additional sheets:	Treatment: BONES COLLECTED LIFTED
Site sub-div: Bay 3	Grave fills:	<del>NO DATA FOR IDENTIFICATION OF DATA</del> <del>LIFTABLE CAPS</del> TAKEN
Plan no: 7	Grave cut:	Finds None. inscript w/ border rec.
Section no:	Skeleton:	Beesplate Grip
Co-ordinates:	Matrix location: Bay 3 adj to 921 & 923	Hinge Bracket
Levels:	Preservation:	Fixing nails Shroud pins
Slide No.	Neg No:	Fabric Other finds

Description *adj 200* adult p.b. coffin. w/ swedish pitch in bottom inner wood.

Discussion E → W

Shape, dimensions and distinguishing characteristics

LID

HEAD 1.87

BASE

0.26  
0.24  
0.567  
0.23 = deep

" Mrs. Sarah Palmer. Died 31<sup>st</sup> January 1824 In her 26<sup>th</sup> Year "

Black border in places, visible @ head/side seam. - near bottom of lid, c. 0.04 cm wide.

Recorder: Mel	Date: 14-11-00	Initials:
------------------	-------------------	-----------

dp.

SITE 01200	COFFIN RECORD SHEET	CONTEXT NO. 923
Trench: CRYPT	Additional sheets:	Treatment: BONES LIFTED DNA TAKEN. FLESH REMAINING
Site sub-div:	Grave fills	
Plan no: 7	Grave cut:	Finds None Inscrip Breastplate Grip
Section no:	Skeleton:	
Co-ordinates:	Matrix location: BAY 3 adj to 922	Hinge Bracket
Levels	Preservation: 1	Fixing nails Shroud pins
Slide No.	Neg No:	Fabric Other finds

Description  
adult p.b. coffin, remains of horsehair mattress.  
~~very old~~ ~~bone~~, craniotomy.  
some skin on face, restated.

Discussion  
W → E

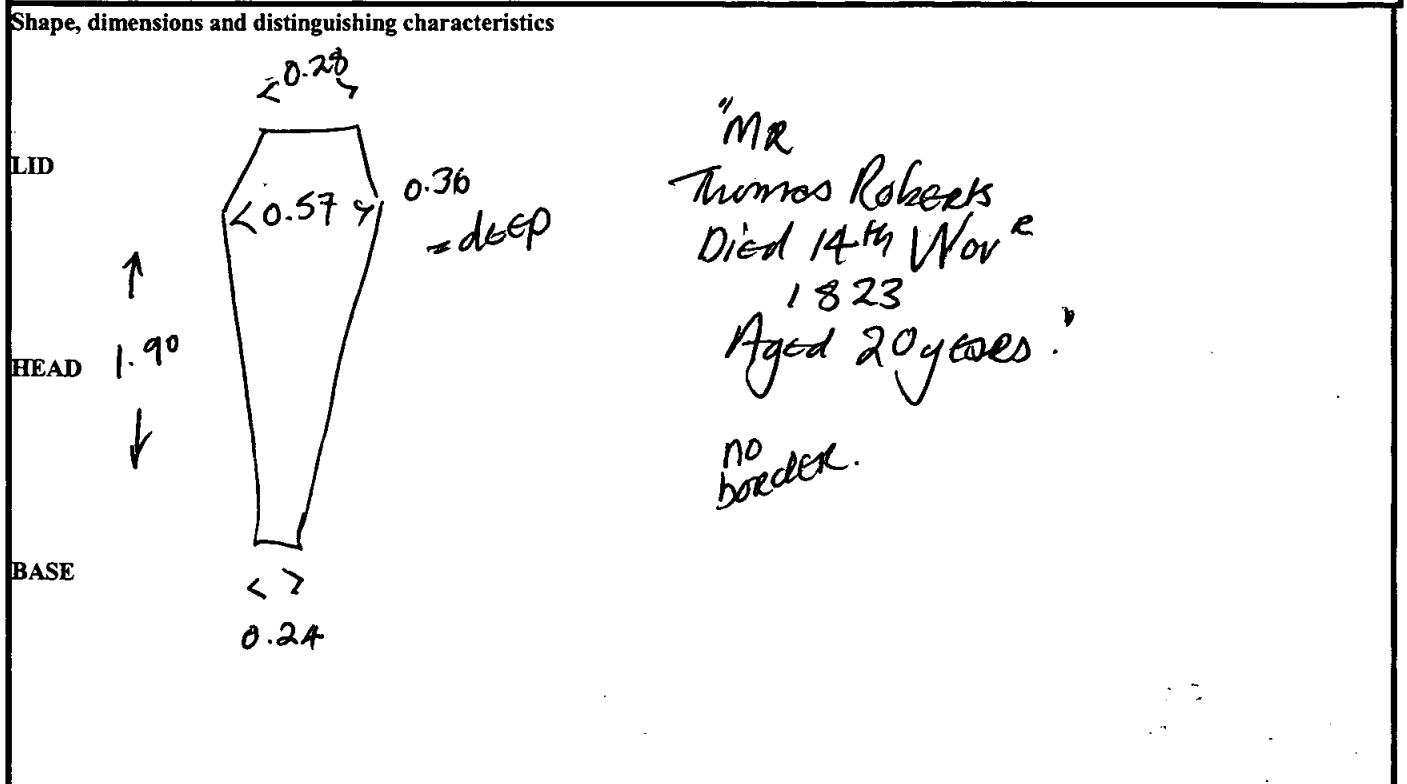

Recorder: M-J Date: 14.11.00 Initials:

db.

SITE		COFFIN RECORD SHEET		CONTEXT NO.	
OLR008				924	
Trench:	CRYPT	Additional sheets:	Treatment:		
Site sub-div:	Box 2	Grave fills:	INTACT → NECR. ADULT		
Plan no:	7	Grave cut:	Finds		
Section no:		Skeleton:	None inscip rott. Breastplate Grip x 1 (1) be.		
Co-ordinates:		Matrix location:	Hinge Bracket		
Levels:		Preservation:	Fixing nails Shroud pins		
Slide No.		Neg No:	Fabric Other finds		

**Description**  
adult p.b. coffin; remains of outer wood, corroded round lid but otherwise intact

**Discussion**

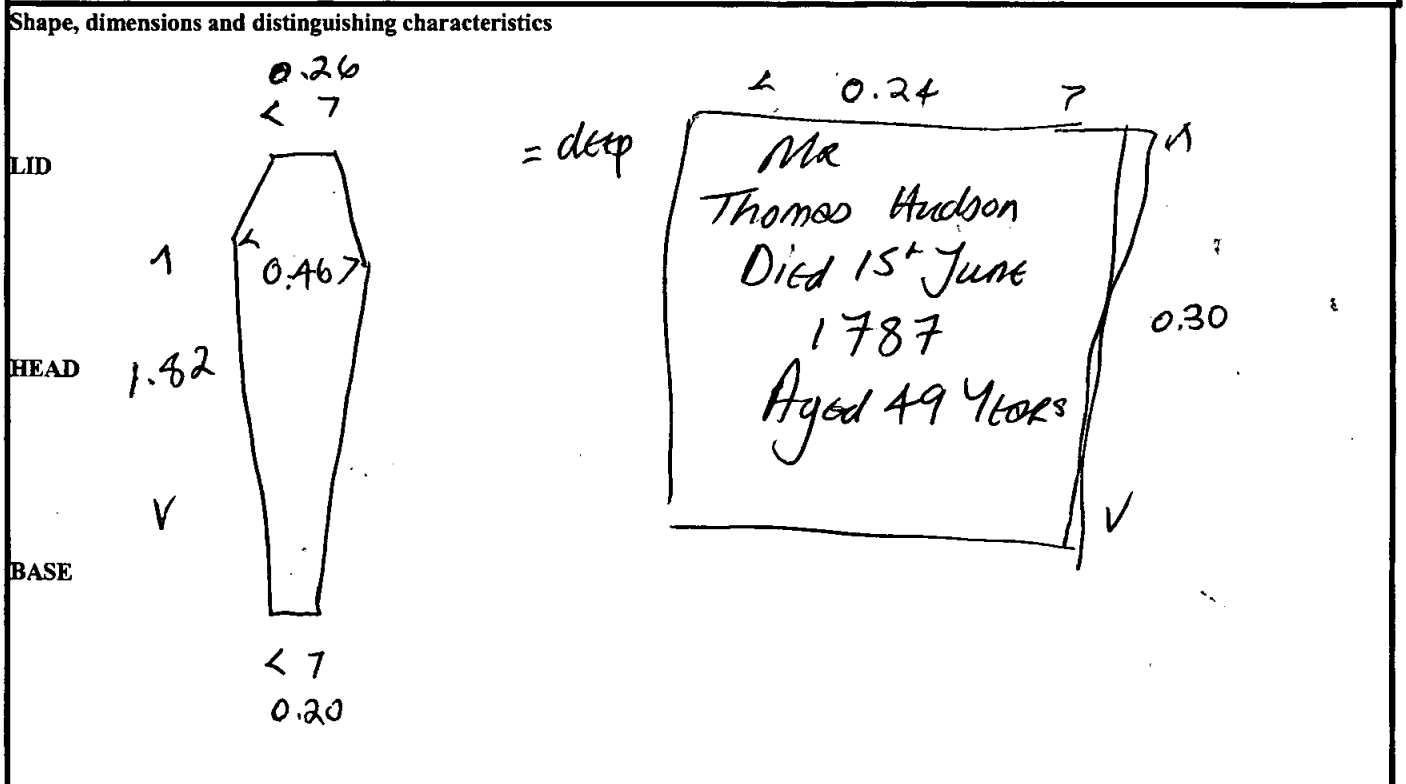

Recorder: TH Date: 14.11.00 Initials:

db

SITE OLR00	COFFIN RECORD SHEET	CONTEXT NO. 925
Trench: CRYPT	Additional sheets:	Treatment: BONES LIFTED, DNA TAKEN
Site sub-div: BAY 3	Grave fills	
Plan no: 7	Grave cut:	Finds None
Section no:	Skeleton:	Breastplate Grip X2 ①5
Co-ordinates:	Matrix location: v/L 806/001/805	Hinge Bracket
Levels	Preservation:	Fixing nails Shroud pins
Slide No.	Neg No:	Fabric Other finds

Description  
W → E adult p.b. coffin. 'lining' shroud over face w/ beaded edging

Discussion

Shape, dimensions and distinguishing characteristics

PB Plate on Coffin: -

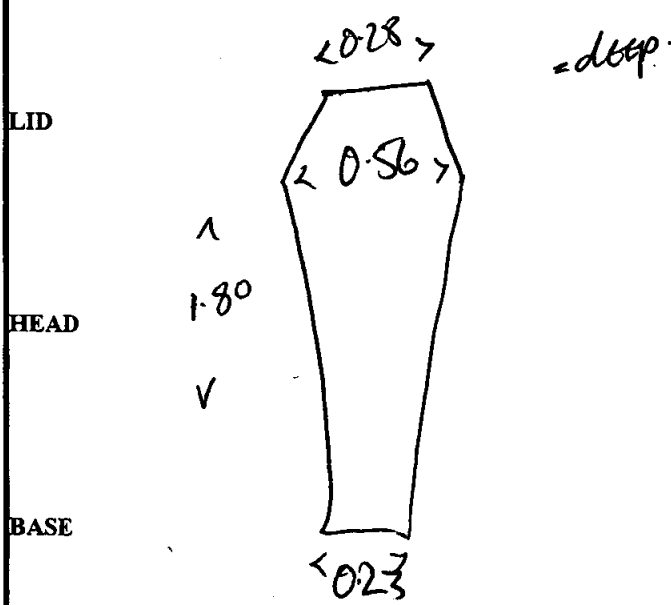

Mrs  
Christina Lanton  
Died 19<sup>th</sup> April  
1779  
Aged 45 Years

Depth: - 0.40m

Recorder: Dy	Date: 14.11.00	Initials:
-----------------	-------------------	-----------

db

SITE OLR00	COFFIN RECORD SHEET	CONTEXT NO. 926
Trench: CRYPT	Additional sheets:	Treatment: NO NAME BONES
Site sub-div: Box 3	Grave fills:	LIFTED
Plan no:	Grave cut:	Finds None
Section no:	Skeleton:	Breastplate Grip
Co-ordinates:	Matrix location: <del>20/102/1871</del> v/l 217/203/896	Hinge Bracket
Levels:	Preservation:	Fixing nails Shroud pins
Slide No.	Neg No:	Fabric Other finds

Description  
 E → W  
 adult p.b coffin  
 NO NAME  
 Kopok? bedding; bones in v. poor cond.

Discussion

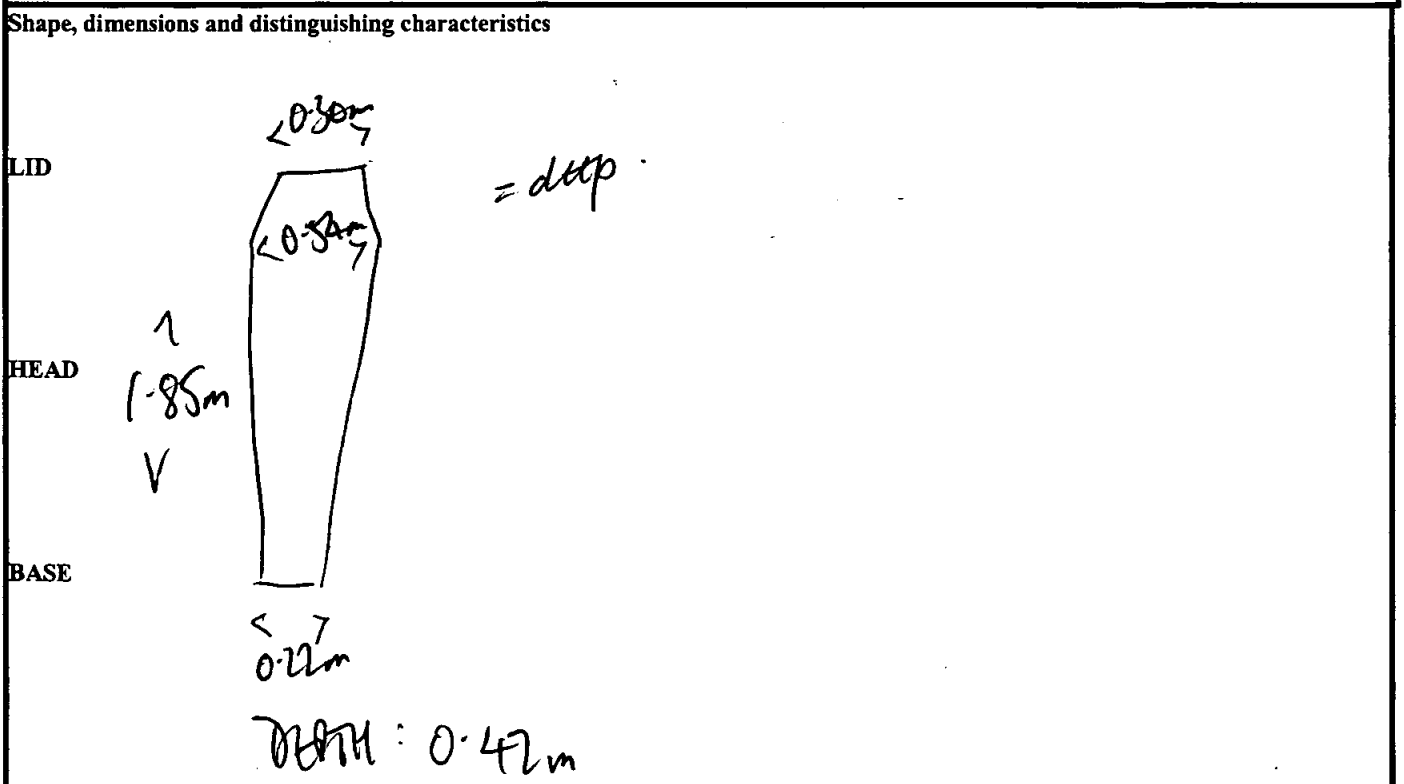

Recorder: D3	Date: 14.11.00	Initials:
-----------------	-------------------	-----------

AD.

SITE OLK00	COFFIN RECORD SHEET	CONTEXT NO. 927
Trench:	Additional sheets: YES x2.	Treatment:
Site sub-div: S.C.	Grave fills	B.C.
Plan no: 6	Grave cut:	Finds None
Section no:	Skeleton: <i>Yard</i>	Breastplate ✓ Grip ✓
Co-ordinates:	Matrix location: <u>873</u> <u>927</u> <u>928</u>	Hinge Bracket
Levels	Preservation: <i>Good</i>	Fixing nails Shroud pins
Slide No.	Neg No:	Fabric Other finds

**Description**  
E-DW INFANT BURIAL. WOODEN COFFIN, WITH 10 BREASTPLATE PINNED TO OVAL WOOD.

**Discussion**

Shape, dimensions and distinguishing characteristics

Recorder: <i>DM/ON</i>	Date: <i>10/11/00</i>	Initials:
------------------------	-----------------------	-----------

**Outer Coffin**

Sample Ret.

Site Code

Context

Recording Date ..... 13/11/00 .....

OR200

927

Associated Numbers .....

Condition ..... 3 .....

Dep. Plate

Legible

Inscription "Miss/Isabella Fuller/Died 11<sup>th</sup> June/1823/Aged 10 Mms/& 12 Days"

Fabric lead  ormolou  brass  tin plated pewter  gilt tin   
 iron  silvered tin  enamelled  other ..... Sample Ret.

**Shape of dep. plate**

square  rectangle  shield  tapered  lozenge   
 cartouche  oval  other ..... *infant*

**Upholstery**

colour ..... shoddy  velvet  other ..... Sample Ret.

**Construction**

butt joint  mitred  pitched  other .....

Grip plate  Fabric = ormolou  brass  tin plated pewter  gilt tin   
 iron  silvered tin  enamelled  other ..... Sample Ret.

Grip  Fabric = ormolou  brass  iron  Sample Ret.

**Design**

swag of rose  horseshoe  cherub's head  plain

other .....

Grip bolts  Corner bolts  Type = gilt brass  brass  iron

other ..... Sample Ret.

Lid motifs  other ..... Sample Ret.

Escutcheons  other ..... Sample Ret.

Upholstery nails  brass  gilt brass  silvered brass  iron  enamelled

other ..... Sample Ret.

Fixings  panel nails  screws  hinges  lace  Sample Ret.

Timber type ..... Sample Ret.

**Interpretation / Comments**

.....  
 .....



Site Code

Context

**Outer Coffin**

Sample Ret.

OH100

927

Recording Date ..... 20/2/01 .....

Associated Numbers .....

Condition .....

Dep. Plate

Legible

Inscription

Fabric lead  ormolou  brass  tin plated pewter  gilt tin   
 iron  silvered tin  enamelled  other ..... Sample Ret.

**Shape of dep. plate**

square  rectangle  shield  tapered  lozenge   
 cartouche  oval  other .....

**Upholstery**

colour ..... shoddy  velvet  other ..... Sample Ret.

**Construction**

butt joint  mitred  pitched  other .....

**Grip plate**

*Fabric = ormolou*  brass  tin plated pewter  gilt tin   
*4 x frogs - unid.*  
 iron  silvered tin  enamelled  other ..... Sample Ret.

**Grip**

Fabric = ormolou  brass  iron  Sample Ret.

**Design**

swag of rose  horseshoe  cherub's head  plain

other .....

**Grip bolts**

**Corner bolts**  Type = gilt brass  brass  iron

other ..... Sample Ret.

**Lid motifs**

other ..... Sample Ret.

**Escutcheons**

other ..... Sample Ret.

**Upholstery**

*studs*  
 nails  brass  gilt brass  silvered brass  iron  enamelled

other ..... *1 x 000 = 4 studs* ..... Sample Ret.

**Fixings**

panel nails  screws  hinges  lace  Sample Ret.

**Timber type**

..... Sample Ret.

**Interpretation / Comments**

.....  
 .....

SITE <u>DLR00</u>		COFFIN RECORD SHEET	CONTEXT NO. <u>928</u>
Trench:	Additional sheets:	Treatment:	
Site sub-div: <u>S.C.</u>	Grave fills	<u>B/DNA CONDUCTED</u>	
Plan no: <u>6</u>	Grave cut:	Finds	
Section no:	Skeleton: <u>POOR</u>	None	
Co-ordinates:	Matrix location: <u>(927)</u> <u>(928)</u>	Breastplate <input checked="" type="checkbox"/>	
Levels	Preservation: <u>POOR</u>	Grip	
Slide No.	Neg No:	Hinge	
		Bracket	
		Fixing nails	
		Shroud pins	
		Fabric	
		Other finds	

**Description** E-W ADULT BURIAL. Pb coffin, PINCH SOLDATOR TOP & BASE. BREASTPLATE PRESENT ON QUERCUS WOOD. SKELTON. Pb I.D. PLATE SOLDERED TO COFFIN BREAST.

**Discussion**

**Shape, dimensions and distinguishing characteristics**

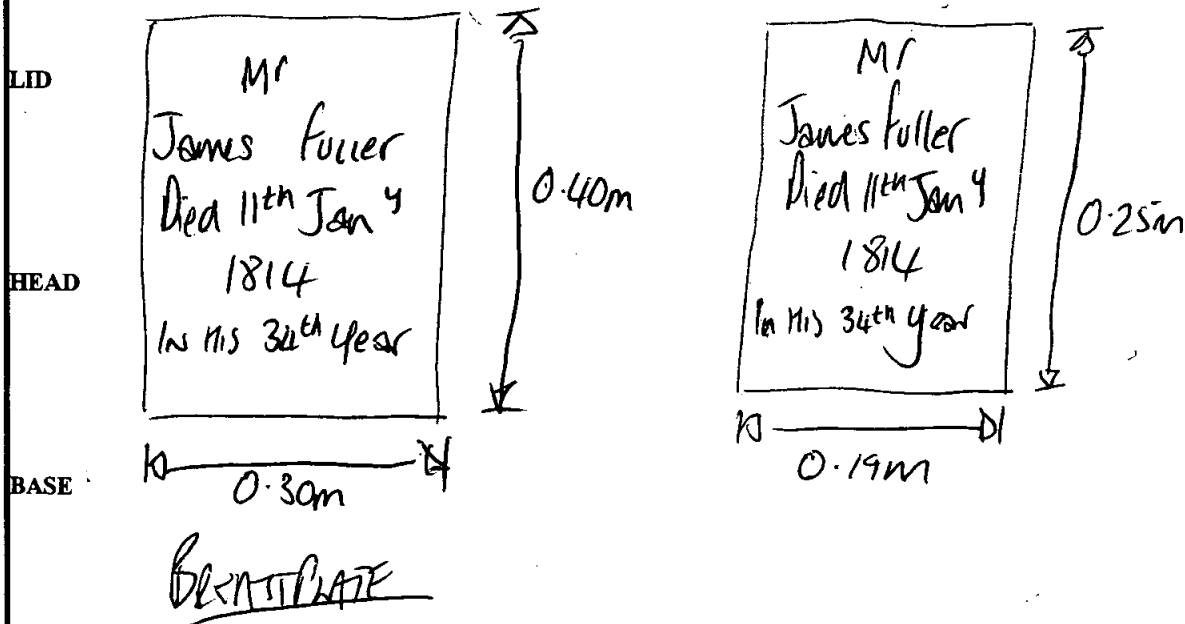

Recorder: <u>DM/PA</u>	Date: <u>10/11/00</u>	Initials:
------------------------	-----------------------	-----------

Site Code

Context

**Outer Coffin**

Sample Ret.

OWR00

928

Recording Date ..... 20/2/01 .....

Associated Numbers .....

Condition ..... 2 .....

Dep. Plate

Legible

Inscription "Mr James Fuller / Died 11<sup>th</sup> Jan'y / 1814 / In his 34<sup>th</sup> Year" 657

Some on ~~top~~ w/  
⑧ border & plain  
outer. gilt tin

Fabric lead  ormolou  brass  tin plated pewter   
iron  silvered tin  enamelled  other ..... Sample Ret.

**Shape of dep. plate**

square  rectangle  shield  tapered  lozenge   
cartouche  oval  other .....

**Upholstery**

colour ..... shoddy  velvet  other ..... Sample Ret.

**Construction** butt joint  mitred  pitched  other .....

**Grip plate**  Fabric = ormolou  brass  tin plated pewter  gilt tin   
iron  silvered tin  enamelled  other ..... Sample Ret.   
*Frogs on rev of grip - wood*

**Grip**  Fabric = ormolou  brass  iron  x 1 Sample Ret.

**Design** swag of rose  horseshoe  cherub's head  ④ plain   
other .....

**Grip bolts**  **Corner bolts**  **Type =** gilt brass  brass  iron

other ..... Sample Ret.

**Lid motifs**  other ..... Sample Ret.

**Escutcheons**  other ..... Sample Ret.

**Upholstery nails**  brass  gilt brass  silvered brass  iron  enamelled   
other ..... Sample Ret.

**Fixings**  panel nails  screws  hinges  lace  Sample Ret.

**Timber type** ..... Sample Ret.

**Interpretation / Comments**

.....  
.....

db.

SITE <b>OL400</b>	COFFIN RECORD SHEET	CONTEXT NO. <b>929</b>
Trench:	Additional sheets:	Treatment:
Site sub-div: <b>S.C.</b>	Grave fills	<b>B.C.</b>
Plan no: <b>6</b>	Grave cut:	Finds None <input checked="" type="checkbox"/>
Section no:	Skeleton: <b>Gown</b>	Breastplate Grip
Co-ordinates:	Matrix location: <b>892</b> <b>929</b>	Hinge Bracket
Levels	Preservation: <b>930</b>	Fixing nails Shroud pins
Slide No.	Neg No:	Fabric Other finds

Description **E → W ADULT BURIAL. WOODEN COFFIN**

Discussion

Shape, dimensions and distinguishing characteristics

LID

HEAD

BASE

Recorder: <b>DM/PT</b>	Date: <b>10/11/60</b>	Initials:
------------------------	-----------------------	-----------

**Outer Coffin**

Sample Ret.

Site Code

Context

Recording Date ..... 16/2/01 .....

OLR00

929

Associated Numbers .....

Condition .....

Dep. Plate

Legible

Inscription

Fabric lead  ormolou  brass  tin plated pewter  gilt tin   
 iron  silvered tin  enamelled  other ..... Sample Ret.

**Shape of dep. plate**

square  rectangle  shield  tapered  lozenge   
 cartouche  oval  other .....

**Upholstery**

colour ..... shoddy  velvet  other ..... Sample Ret.

**Construction**

butt joint  mitred  pitched  other .....

Grip plate  Fabric = ormolou  brass  tin plated pewter  gilt tin   
 iron  silvered tin  enamelled  other ..... Sample Ret.

Grip  Fabric = ormolou  brass  iron  Sample Ret.

Design swag of rose  horseshoe  cherub's head  plain   
 other .....

Grip bolts  Corner bolts  Type = gilt brass  brass  iron

other ..... Sample Ret.

Lid motifs  other ..... Sample Ret.

Escutcheons  other ..... Sample Ret.

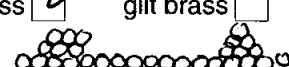
Upholstery <sup>studs</sup> nails  brass  gilt brass  silvered brass  iron  enamelled   
 other ..... 1 x piece  = 29 studs ..... Sample Ret.

Fixings  panel nails  screws  hinges  lace  Sample Ret.

Timber type ..... Sample Ret.

**Interpretation / Comments**

.....  
 .....

db.

SITE <i>OK00</i>	COFFIN RECORD SHEET	CONTEXT NO. <i>930</i>
Trench:	Additional sheets:	Treatment:
Site sub-div: <i>S.C.</i>	Grave fills	<i>B.C.</i>
Plan no: <i>6</i>	Grave cut:	Finds None <input checked="" type="checkbox"/>
Section no:	Skeleton: <i>Good</i>	Breastplate Grip
Co-ordinates:	Matrix location: <i>929</i> <i>930</i> <i>931</i>	Hinge Bracket
Levels	Preservation:	Fixing nails Shroud pins
Slide No.	Neg No:	Fabric Other finds

Description  
*E → W INFANT BURIAL. WOODEN COFFIN.*

Discussion

Shape, dimensions and distinguishing characteristics

LID

HEAD

BASE

Recorder: <i>DM/DM</i>	Date: <i>10/11/00</i>	Initials:
------------------------	-----------------------	-----------

NP.

SITE 01200	COFFIN RECORD SHEET	CONTEXT NO. 931
Trench:	Additional sheets:	Treatment:
Site sub-div: S.C.	Grave fills	B.C.
Plan no: 6	Grave cut:	Finds None ✓
Section no:	Skeleton: 4000	Breastplate Grip
Co-ordinates:	Matrix location: 930 931	Hinge Bracket
Levels	Preservation:	Fixing nails Shroud pins
Slide No.	Neg No:	Fabric Other finds

**Description** E & W ADULT BURIAL. Wooden coffin:

**Discussion** 2nd right ME, 3rd & 5th ME  
 Left Medial Luniform  
 Left & right intermediate luniform } Adult  
 Likely to be from 929

Shape, dimensions and distinguishing characteristics

LID

HEAD

BASE

Recorder: [Signature]	Date: 10/11/80	Initials:
-----------------------	----------------	-----------

SITE <i>21100</i>		COFFIN RECORD SHEET		CONTEXT NO. <i>932</i>	
Trench:	Additional sheets:	Treatment:			
Site sub-div: <i>5C</i>	Grave fills:	<i>BONES LIAED</i>			
Plan no: <i>6</i>	Grave cut:	Finds			
Section no:	Skeleton: <i>Good.</i>	None			
Co-ordinates:	Matrix location: <i>(931) u/l (930)</i> <i>(932) u/l (934)</i>	Breastplate			
Levels:	Preservation:	Grip <input checked="" type="checkbox"/>			
Slide No.:	Neg No.:	Hinge			
Description: <i>EAST-WEST ADULT BURIAL - WOOD COFFIN</i>		Bracket			
Discussion:		Fixing nails			
Shape, dimensions and distinguishing characteristics:		Shroud pins			
LID:		Fabric			
HEAD:		Other finds:			
BASE:					
Recorder: <i>Ry</i>	Date: <i>12.11.00</i>	Initials:			



Site Code

Context

**Outer Coffin**

Sample Ret.

OH200

932

Recording Date ..... 22/2/01 .....

Associated Numbers .....

Condition .....

Dep. Plate

Legible

Inscription

Fabric lead  ormolou  brass  tin plated pewter  gilt tin   
 iron  silvered tin  enamelled  other ..... Sample Ret.

**Shape of dep. plate**

square  rectangle  shield  tapered  lozenge   
 cartouche  oval  other .....

**Upholstery**  - textile - hessian type coarse weave w/ cu. alloy staining

colour ..... shoddy  velvet  other ..... Sample Ret.

**Construction** butt joint  mitred  pitched  other .....

**Grip plate**  Fabric = ormolou  brass  tin plated pewter  gilt tin   
 iron  silvered tin  enamelled  other ..... Sample Ret.   
*Frag on rev of grip-und.*

**Grip**  Fabric = ormolou  brass  iron  <sup>x2</sup> Sample Ret.

**Design** swag of rose  horseshoe  cherub's head  <sup>(4) 15</sup> plain   
 other .....

**Grip bolts**  **Corner bolts**  **Type =** gilt brass  brass  iron   
 other ..... Sample Ret.

**Lid motifs**  other ..... Sample Ret.

**Escutcheons**  other ..... Sample Ret.

**Upholstery nails**  brass  gilt brass  silvered brass  iron  enamelled   
 other ..... Sample Ret.

**Fixings**  panel nails  screws  hinges  lace  Sample Ret.

**Timber type** ..... Sample Ret.

**Interpretation / Comments**

.....  
 .....

SITE		COFFIN RECORD SHEET		CONTEXT NO.	
02/100		Additional sheets: YES x1		933	
Trench:		Grave fills		Treatment: BONES LIFTED	
Site sub-div: SC		Grave cut:		Finds	
Plan no: 6		Skeleton:		None	
Section no:		Matrix location: 933 O/L 935		Breastplate	
Co-ordinates:		935		Grip ✓	
Levels		Preservation: SQUASHED/RAMANA'S - DAMAGED PROB. BY 934 TO NORTH		Hinge	
Slide No.		Neg No:		Bracket	
				Fixing nails	
				Shroud pins	
				Fabric	
				Other finds	

**Description** (5) Coffin - ADULT - PINNED. E-W ORIENTATED. SOLDERED ID PLATE NOT INTACT. **Discussion** LINGER WOOD COFFIN PRESENT. SANDUST

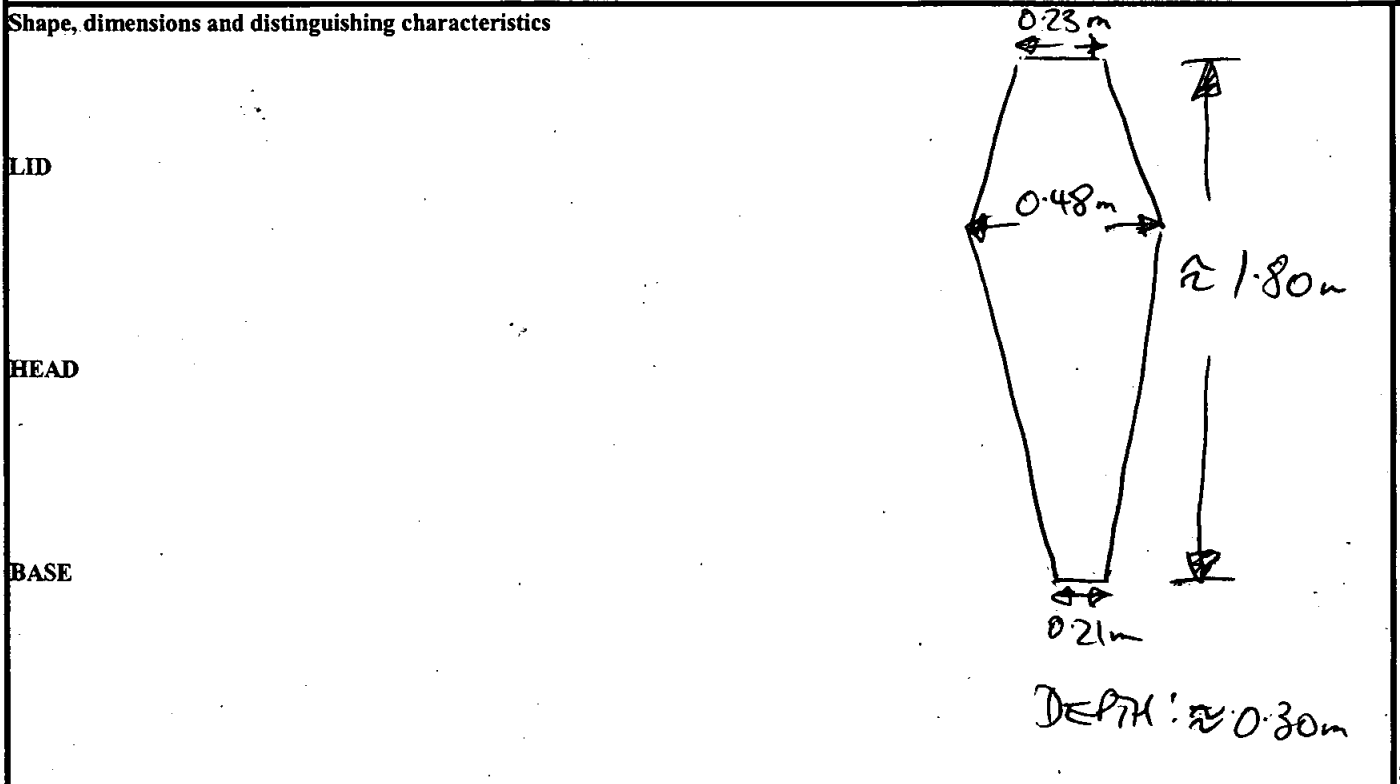

Recorder: Dm Date: 12.11.00 Initials:

Site Code

Context

**Outer Coffin**

Sample Ret.

*0200*

*933*

Recording Date *13/2/01*

Associated Numbers .....

Condition .....

Dep. Plate

Legible

Inscription

Fabric lead  ormolou  brass  tin plated pewter  gilt tin   
iron  silvered tin  enamelled  other ..... Sample Ret.

**Shape of dep. plate**

square  rectangle  shield  tapered  lozenge   
cartouche  oval  other .....

**Upholstery**

colour ..... shoddy  velvet  other ..... Sample Ret.

**Construction**

butt joint  mitred  pitched  other .....

Grip plate  Fabric = ormolou  brass  tin plated pewter  gilt tin   
*bag of cartouche on rev. of grip-und.* iron  silvered tin  enamelled  other ..... Sample Ret.

Grip  Fabric = ormolou  brass  iron  *x1* Sample Ret.

Design swag of rose  horseshoe  cherub's head  *too conc to id* plain   
other .....

Grip bolts  Corner bolts  Type = gilt brass  brass  iron

other ..... Sample Ret.

Lid motifs  other ..... Sample Ret.

Escutcheons  other ..... Sample Ret.

Upholstery *studs*  brass  gilt brass  silvered brass  iron  enamelled   
*nails* other *5 x pines / 3 x oak / 1 x oak / 1 x oak = 19 studs* Sample Ret.

Fixings  panel nails  screws  hinges  lace  Sample Ret.

Timber type ..... Sample Ret.

**Interpretation / Comments**

.....  
.....

SITE <i>OLNoo</i>		COFFIN RECORD SHEET	CONTEXT NO. <i>934</i>
Trench:	Additional sheets:	Treatment: <i>DNA / BONES.</i>	
Site sub-div: <i>SL.</i>	Grave fills:		
Plan no: <i>6.</i>	Grave cut:	Finds None	
Section no:	Skeleton:	Breastplate Grip	
Co-ordinates:	Matrix location: <i>(934) o/r (938)</i> <i>(936)</i>	Hinge Bracket	
Levels:	Preservation: <i>corroded / split</i>	Fixing nails Shroud pins	
Slide No.	Neg No:	Fabric Other finds	

**Description** *Pb Coffin - Adult. E-W ORIENTATED SOLIDED. (INNER PRESENT)*

**Discussion** *NO VISIBLE OUTER WOODS. Probably dug in after (933) is damaged N. side of (933)*

**Pb Coffin Plate** :-

*Mrs Cath<sup>e</sup> Allan*  
*died 25<sup>th</sup> Feb<sup>y</sup> 1824*  
*Aged 63<sup>y</sup>*

*0.28m*  
*0.23m*

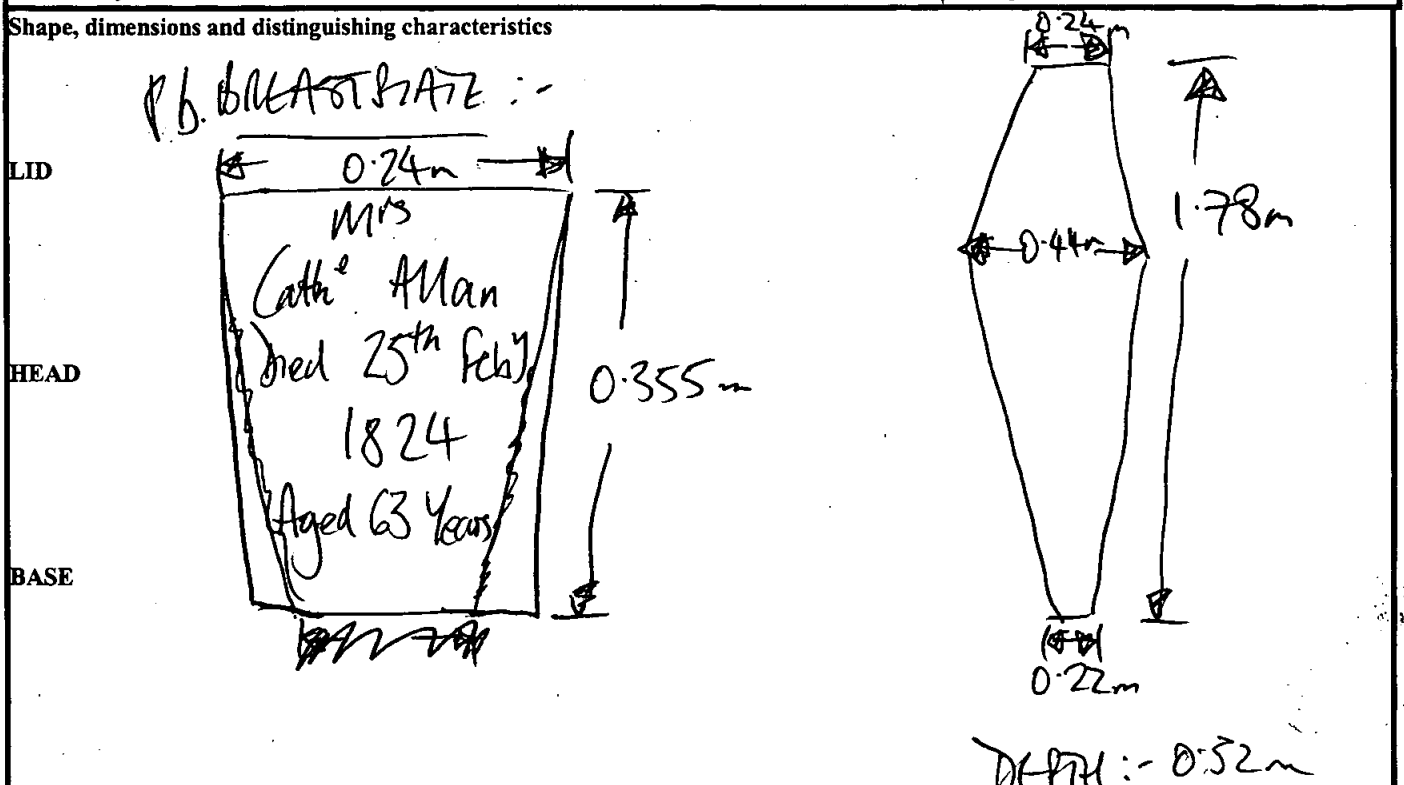

Recorder: <i>DM</i>	Date: <i>12.11.00</i>	Initials:
---------------------	-----------------------	-----------

Site Code

Context

**Outer Coffin**

Sample Ret.

OLR00

934

Recording Date ..... 14/2/01 .....

Associated Numbers .....

Condition ..... 2 .....

Dep. Plate

Legible  154

Inscription "Mrs/Co:th<sup>e</sup> Allen/Died 25<sup>th</sup> Feb<sup>y</sup>/1824/Aged 63 Yrs"  
Some 20 A.76

Fabric lead  ormolou  brass  tin plated pewter  gilt tin   
iron  silvered tin  enamelled  other ..... Sample Ret.

**Shape of dep. plate**

square  rectangle  shield  tapered  lozenge   
cartouche  oval  other .....

**Upholstery**

colour ..... shoddy  velvet  other ..... Sample Ret.

**Construction** butt joint  mitred  pitched  other .....

**Grip plate**  Fabric = ormolou  brass  tin plated pewter  gilt tin   
iron  silvered tin  enamelled  other ..... Sample Ret.

**Grip**  Fabric = ormolou  brass  iron  Sample Ret.

**Design** swag of rose  horseshoe  cherub's head  plain   
other .....

**Grip bolts**  **Corner bolts**  Type = gilt brass  brass  iron   
other ..... Sample Ret.

**Lid motifs**  other ..... Sample Ret.

**Escutcheons**  other ..... Sample Ret.

**Upholstery nails**  brass  gilt brass  silvered brass  iron  enamelled   
other ..... Sample Ret.

**Fixings**  panel nails  screws  hinges  lace  Sample Ret.

**Timber type** ..... Sample Ret.

**Interpretation / Comments**

.....  
.....

SITE		COFFIN RECORD SHEET		CONTEXT NO.	
0LR00				935	
Trench:		Additional sheets:		Treatment: DNA/BONES	
Site sub-div: SL		Grave fills:		- NO TEETH	
Plan no: 6		Grave cut:		Finds	
Section no:		Skeleton:		None	
Co-ordinates:		Matrix location: 933		Breastplate ✓	
Levels:		935 J/L 933		Grip	
Slide No.:		Preservation: CORRODED / SPLIT		Hinge	
				Bracket	
				Fixing nails	
				Shroud pins	
				Fabric	
				Other finds	

**Description** Pb ADULT COFFIN - PINNED.  
EAST - WEST  
TRACES OF OUTER WOOD  
INNER WOOD VISIBLE.

**Discussion** SANDUST

Inscribed Pb Soldered Plate: -  
0.24m x 0.29m - ILLEGIBLE

**Shape, dimensions and distinguishing characteristics**  
Pb OUTER BREASTPLATE: -

LID

HEAD 0.41m

BASE

0.305m

Mrs. Eliz<sup>th</sup> Richardson  
Died Aug<sup>st</sup> 11<sup>th</sup>  
Aged 39

0.28m

0.48m

1.75m

0.22m

DEPTH: -

Recorder: [Signature]

Date: 12.11.00.

Initials:

Outer Coffin

Sample Ret.

Site Code

Context

Recording Date ..... 15/2/01

02200

935

Associated Numbers .....

Condition ..... 4

Dep. Plate

Legible

Inscription

"Mrs Eliz<sup>th</sup>/Richardson/Died Aug 11<sup>th</sup>/1771/Aged 39"

new type, see following sheet. w/ (64) outer border only.

Fabric lead

ormolou

brass

tin plated pewter

gilt tin

iron

silvered tin

enamelled

other .....

Sample Ret.

Shape of dep. plate

square

rectangle

shield

tapered

lozenge

cartouche

oval

other .....

Upholstery

colour .....

shoddy

velvet

other .....

Sample Ret.

Construction

butt joint

mitred

pitched

other .....

Grip plate

Fabric = ormolou

brass

tin plated pewter

gilt tin

iron

silvered tin

enamelled

other .....

Sample Ret.

Grip

Fabric = ormolou

brass

iron  x 2

Sample Ret.

Design

swag of rose

horseshoe

cherub's head

①'s

plain

other .....

Grip bolts

Corner bolts

Type = gilt brass

brass

iron

other .....

Sample Ret.

Lid motifs

other .....

Sample Ret.

Escutcheons

other .....

Sample Ret.

Upholstery ~~nails~~ <sup>studs</sup>

brass

gilt brass

silvered brass

iron

enamelled

other .....

3x singles

Sample Ret.

Fixings

panel nails

screws

hinges

lace

Sample Ret.

Timber type .....

Sample Ret.

Interpretation / Comments

.....  
 .....

SITE		COFFIN RECORD SHEET		CONTEXT NO.	
02000				936	
Trench:	Additional sheets:	Treatment: JNA / bones			
Site sub-div: SC	Grave fills:				
Plan no: 6.	Grave cut:	Finds: None			
Section no:	Skeleton:	Breastplate <input checked="" type="checkbox"/> Grip <input checked="" type="checkbox"/>			
Co-ordinates:	Matrix location: (934) o/L (936) (936) o/L (93A)	Hinge Bracket			
Levels:	Preservation: poor / split.	Fixing nails Shroud pins			
Slide No.:	Neg No:	Fabric Other finds			

**Description** Pb ADJCT COFFIN EAST - WEST. SOLDERED. OUTER / INNER WOOD.

**Discussion** Inscribed Pb Plate: - (Soldered)

James Allen  
Esq  
Died 27<sup>th</sup> Jan<sup>y</sup>  
1819  
Aged 78 Years

0.25m

0.22m

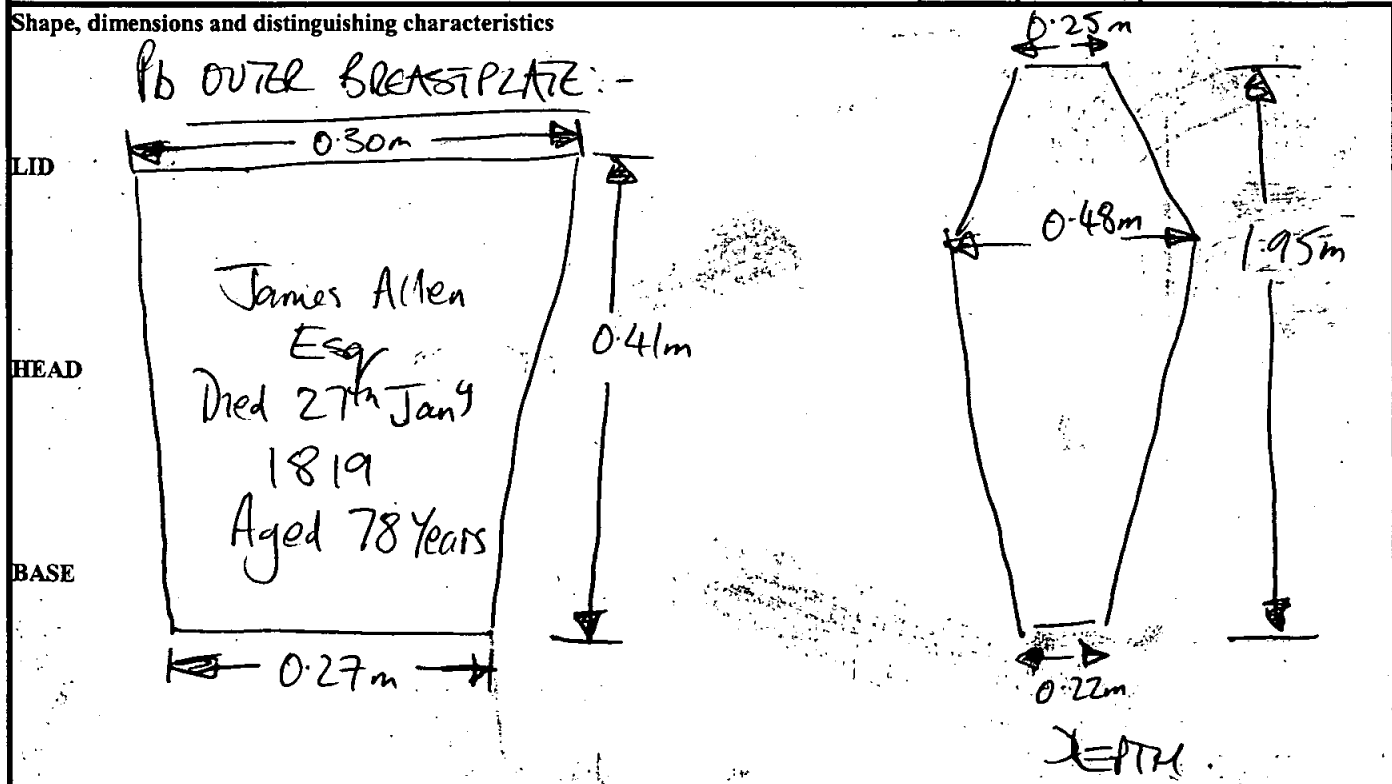

Recorder: Jm Date: 12-11-00 Initials:



Site Code

Context

**Outer Coffin**

Sample Ret.

*OR00*

*936*

Recording Date ..... *20/2/01* .....

Associated Numbers .....

Condition .....

Dep. Plate

Legible

Inscription

**Fabric** lead  ormolou  brass  tin plated pewter  gilt tin   
 iron  silvered tin  enamelled  other ..... Sample Ret.

**Shape of dep. plate**

square  rectangle  shield  tapered  lozenge   
 cartouche  oval  other .....

**Upholstery**

colour ..... shoddy  velvet  other ..... Sample Ret.

**Construction**

butt joint  mitred  pitched  other .....

**Grip plate**  **Fabric =** ormolou  brass  tin plated pewter  gilt tin   
 iron  silvered tin  enamelled  other ..... Sample Ret.

**Grip**  **Fabric =** ormolou  brass  iron  *x2* Sample Ret.

**Design** swag of rose  horseshoe  cherub's head  *(4)5* plain   
 other .....

**Grip bolts**  **Corner bolts**  **Type =** gilt brass  brass  iron

other ..... Sample Ret.

**Lid motifs**  other ..... Sample Ret.

**Escutcheons**  other ..... Sample Ret.

**Upholstery nails**  brass  gilt brass  silvered brass  iron  enamelled   
 other ..... Sample Ret.

**Fixings**  panel nails  screws  hinges  lace  Sample Ret.

**Timber type** ..... Sample Ret.

**Interpretation / Comments**

.....  
 .....

**Outer Coffin**

Sample Ret.

Site Code

Context

Recording Date ..... 20/2/01 .....

OLR00

936

Associated Numbers .....

Condition ..... 3 .....

Dep. Plate

Legible

Inscription "James Allson/Esq<sup>re</sup>/Died 27<sup>th</sup> Jan'y/1819/Aged 78 Years"

*same as 1193  
w/ 1133 border (inset)  
= plain outer  
gilt tin*

Fabric lead  ormolou  brass  tin plated pewter   
iron  silvered tin  enamelled  other ..... Sample Ret.

*black polished*

**Shape of dep. plate**

square  rectangle  shield  tapered  lozenge   
cartouche  oval  other .....

**Upholstery**

colour ..... shoddy  velvet  other ..... Sample Ret.

**Construction**

butt joint  mitred  pitched  other .....

Grip plate  Fabric = ormolou  brass  tin plated pewter  gilt tin   
iron  silvered tin  enamelled  other ..... Sample Ret.

Grip  Fabric = ormolou  brass  iron  Sample Ret.

Design swag of rose  horseshoe  cherub's head  plain   
other .....

Grip bolts  Corner bolts  Type = gilt brass  brass  iron   
other ..... Sample Ret.

Lid motifs  other ..... Sample Ret.

Escutcheons  other ..... Sample Ret.

Upholstery nails  brass  gilt brass  silvered brass  iron  enamelled   
other ..... Sample Ret.

Fixings  panel nails  screws  hinges  lace  Sample Ret.

Timber type ..... Sample Ret.

**Interpretation / Comments**

.....  
.....

SITE <u>OLR 00</u>		COFFIN RECORD SHEET	CONTEXT NO. <u>937</u>
Trench:	Additional sheets:	Treatment: <u>BONES LIFTED</u>	
Site sub-div: <u>SC</u>	Grave fills:		
Plan no: <u>6</u>	Grave cut:	Finds None	
Section no:	Skeleton:	Breastplate Grip	
Co-ordinates:	Matrix location: <u>935</u> o/l <u>937</u> <u>937</u> u/l <u>935</u>	Hinge Bracket	
Levels:	Preservation:	Fixing nails Shroud pins	
Slide No.:	Neg No.:	Fabric Other finds	

Description EAST-WEST BURIAL. WOOD COFFIN.  
ADULT.

Discussion TRACES OF WOOD COFFIN / Cu ALLOY STUDWORK

Shape, dimensions and distinguishing characteristics

LID

Extra bones:  
R. clavicle  
R scapula  
Head of R humerus  
C 1-7  
T 1-8

} Same individual  
935?

HEAD

BASE

Recorder: <u>DM</u>	Date: <u>12/11/00</u>	Initials:
---------------------	-----------------------	-----------

SITE <u>OUR 00</u>		COFFIN RECORD SHEET	CONTEXT NO. <u>938</u>
Trench:	Additional sheets:	Treatment: <u>DNA/BONAJ</u>	
Site sub-div: <u>SC</u>	Grave fills:		
Plan no: <u>6</u>	Grave cut:	Finds None	
Section no:	Skeleton:	Breastplate Grip	
Co-ordinates:	Matrix location: <u>938</u>	Hinge Bracket	
Levels:	Preservation: <u>POOR, CORRODED AND SPLIT</u>	Fixing nails Shroud pins	
Slide No.:	Neg No.:	Fabric Other finds	

Description Pb COFFIN - ADULT  
E-W ORIENTED, INNER WOOD VISIBLE  
SANDUST, SOLDERED

Pb COFFIN PLATE:

Mr  
Charles Allen  
Died 9th Oct  
1916  
Aged 27 Years

24cm

Discussion

Shape, dimensions and distinguishing characteristics

Pb OUTER BREASTPLATE: ✓

LID

HEAD

BASE

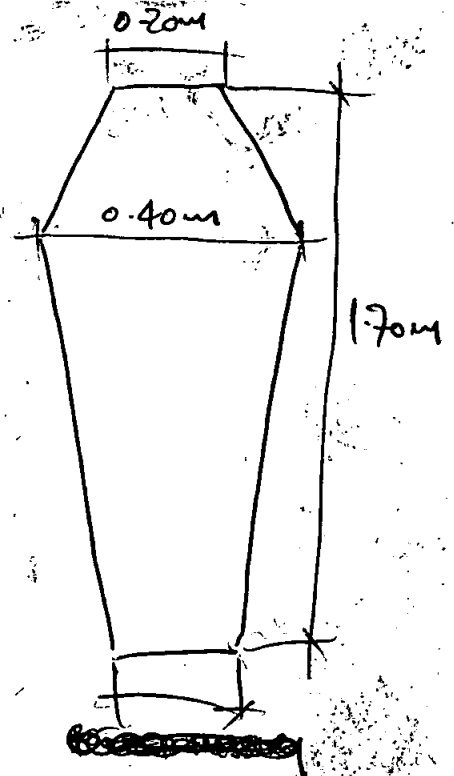

Recorder: <u>D. MARIČEVIĆ</u>	Date: <u>13/11/00</u>	Initials:
-------------------------------	-----------------------	-----------

**Outer Coffin**

Sample Ret.

Site Code

Context

Recording Date ..... 15/2/01 .....

06R00

938

Associated Numbers .....

Condition ..... 1 .....

Dep. Plate

Legible  ISH

Inscription "Mrs/Charlotte Allen/Died ? Oct/18?6/Aged 27 Years"

(82) w/253 border - i.e. same as 253.

Fabric lead  ormolou  brass  tin plated pewter  gilt tin   
 iron  silvered tin  enamelled  other ..... Sample Ret.

black polished.

**Shape of dep. plate**

square  rectangle  shield  tapered  lozenge   
 cartouche  oval  other .....

**Upholstery**

colour ..... shoddy  velvet  other ..... Sample Ret.

**Construction**

butt joint  mitred  pitched  other .....

Grip plate  Fabric = ormolou  brass  tin plated pewter  gilt tin   
 iron  silvered tin  enamelled  other ..... Sample Ret.

Grip  Fabric = ormolou  brass  iron  Sample Ret.

Design swag of rose  horseshoe  cherub's head  plain   
 other .....

Grip bolts  Corner bolts  Type = gilt brass  brass  iron

other ..... Sample Ret.

Lid motifs  other ..... Sample Ret.

Escutcheons  other ..... Sample Ret.

Upholstery nails  brass  gilt brass  silvered brass  iron  enamelled   
 other ..... Sample Ret.

Fixings  panel nails  screws  hinges  lace  Sample Ret.

Timber type ..... Sample Ret.

**Interpretation / Comments**

.....  
 .....

db

SITE 06R 00	COFFIN RECORD SHEET	CONTEXT NO. 339
Trench:	Additional sheets: 463 x 1	Treatment: <u>BONE</u> , <u>NO DNA</u>
Site sub-div: se	Grave fills	
Plan no: 6	Grave cut:	Finds None
Section no:	Skeleton:	Breastplate Grip
Co-ordinates:	Matrix location: (940) o/l (939) (939) u/l (940)	Hinge Bracket
Levels	Preservation:	Fixing nails Shroud pins
Slide No.	Neg No:	Fabric Other finds

**Description**  
E-W ORIENTATED Pb-COFFIN, INNER WOOD  
POOR CONDITION, SPLIT, SOLDERED, BRADUT CORRODED AROUND THE LID  
PLATE NOT READABLE IN FIELD (POSSIBLY READABLE)

**Discussion**  
OUTTER BREASTPLATE NOT READABLE  
SOLDERED LID-LINING PLATE → REBECCA ~~OF~~ LIOVA STM.  
BONES IN POOR CONDITION POSSIBLY

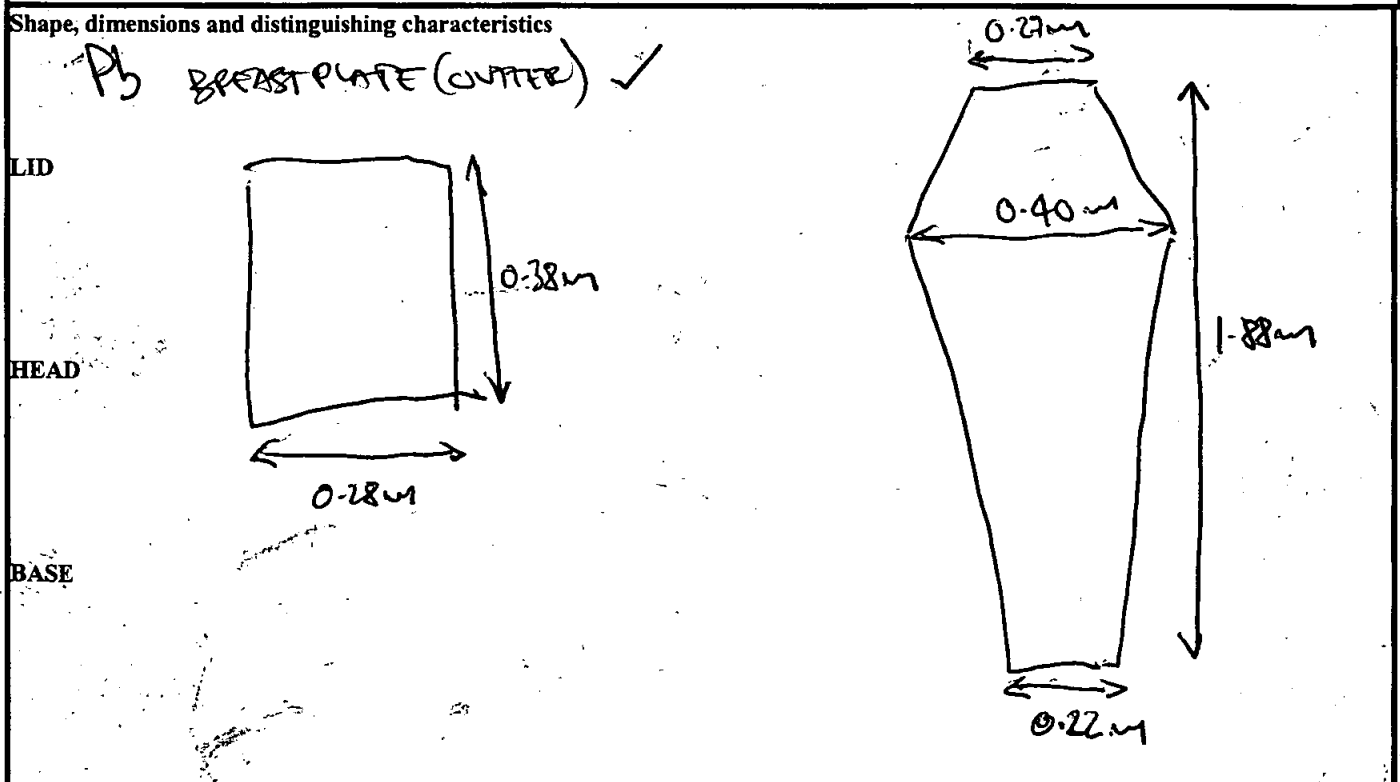

Recorder: DM Date: 14/11/00 Initials:

**Outer Coffin**

Sample Ret.

Site Code

Context

Recording Date ..... 13/12/00 .....

**07200**

**939**

Associated Numbers .....

Condition ..... 2 .....

Dep. Plate

Legible

Inscription Ms ~~Allen~~ Rebecca/Lydia Allen/Died 10<sup>th</sup> May/1819/Aged 37 Years  
some no 393.

Fabric lead  ormolou  brass  tin plated pewter  gilt tin   
iron  silvered tin  enamelled  other ..... Sample Ret.

black polished.

**Shape of dep. plate**

square  rectangle  shield  tapered  lozenge   
cartouche  oval  other .....

**Upholstery**

colour ..... shoddy  velvet  other ..... Sample Ret.

**Construction**

butt joint  mitred  pitched  other .....

Grip plate  Fabric = ormolou  brass  tin plated pewter  gilt tin   
iron  silvered tin  enamelled  other ..... Sample Ret.

Grip  Fabric = ormolou  brass  iron  Sample Ret.

Design swag of rose  horseshoe  cherub's head  plain   
other .....

Grip bolts  Corner bolts  Type = gilt brass  brass  iron   
other ..... Sample Ret.

Lid motifs  other ..... Sample Ret.

Escutcheons  other ..... Sample Ret.

Upholstery nails  brass  gilt brass  silvered brass  iron  enamelled   
other ..... Sample Ret.

Fixings  panel nails  screws  hinges  lace  Sample Ret.

Timber type ..... Sample Ret.

**Interpretation / Comments**

.....  
.....

db.

SITE	COFFIN RECORD SHEET	CONTEXT NO.
OLR 00	Additional sheets: 462 x 1.	940 Treatment: BONES LIFTED
Trench:	Grave fills	
Site sub-div: SC	Grave cut:	Finds
Plan no: 6	Skeleton:	None
Section no:	Matrix location:	Breastplate
Co-ordinates:	940 o/L 939 939 o/L 941	Grip
Levels	Preservation:	Hinge
Slide No.	Neg No:	Bracket
Description		Fixing nails
Discussion		Shroud pins
Shape, dimensions and distinguishing characteristics		Fabric
LID		Other finds
HEAD		
BASE		
Recorder: DM	Date: 14/11/00	Initials:

JUVENILE BURIAL. E-W ORIENTATED.  
WOODEN COFFIN, w ALLOY STRUWERE  
PLACED ON TOP OF Pb-COFFIN (939)

~~Possible mixing with (939)~~  
~~Estimated bones!~~  
~~Left scapula~~ female, Adult



# Coffin Recording Sheet

**Outer Coffin**

Sample Ret.

Site Code

Context

OLR00

940

Recording Date ..... 13/12/00 .....

Associated Numbers .....

Condition .....

Dep. Plate

Legible

Inscription

Fabric lead  ormolou  brass  tin plated pewter  gilt tin   
 iron  silvered tin  enamelled  other ..... Sample Ret.

**Shape of dep. plate**

square  rectangle  shield  tapered  lozenge   
 cartouche  oval  other .....

**Upholstery**

colour ..... shoddy  velvet  other ..... Sample Ret.

**Construction**

butt joint  mitred  pitched  other .....

**Grip plate**

Fabric = ormolou  brass  tin plated pewter  gilt tin   
 iron  *Frag - dec but not enough to id.* silvered tin  enamelled  other ..... Sample Ret.

**Grip**

Fabric = ormolou  brass  iron  Sample Ret.

**Design**

swag of rose  horseshoe  cherub's head  plain

other .....

**Grip bolts**

Corner bolts  Type = gilt brass  brass  iron

other ..... Sample Ret.

**Lid motifs**

other ..... Sample Ret.

**Escutcheons**

other ..... Sample Ret.

**Upholstery** <sup>studs</sup>

brass  gilt brass  silvered brass  iron  enamelled

other ..... *2 x pieces - 00 / 0000 = 6 studs in total* Sample Ret.

**Fixings**

panel nails  screws  hinges  lace  Sample Ret.

**Timber type**

Sample Ret.

**Interpretation / Comments**

.....  
 .....

db

SITE OLR 00	COFFIN RECORD SHEET	CONTEXT NO. 941
Trench:	Additional sheets:	Treatment: BONES LIFTED
Site sub-div: se	Grave fills:	
Plan no: 6	Grave cut:	Finds None
Section no:	Skeleton:	Breastplate Grip
Co-ordinates:	Matrix location: 939 O/L 941 941 U/L 939	Hinge Bracket
Levels:	Preservation:	Fixing nails Shroud pins 1 x Fe stud
Slide No.:	Neg No.:	Fabric Other finds

Description BURIAL JUVENILE. E-W ORIENTATED.  
TRUNCATED AT LOWER LEGS (KNEE DOWN). WOOD COFFIN.  
POSSIBLY TRUNCATED AT ~~RIGHT~~<sup>LEFT</sup>-HAND SIDE(?)

Discussion  
ADULT NOT JU.

Shape, dimensions and distinguishing characteristics

LID  
HEAD  
BASE

Possible mixing with 939  
Extra bones:  
2 Pelvis } Adult ♀  
2 Scapula }

Recorder: DM	Date: 14/11/00	Initials:
--------------	----------------	-----------

db.

SITE OUR 00	COFFIN RECORD SHEET	CONTEXT NO. 942
Trench:	Additional sheets: YES X1	Treatment: BONES LIFTED
Site sub-div: se	Grave fills	PACKED IN BAG WITH (943)
Plan no: 6	Grave cut:	Findings None
Section no:	Skeleton:	Breastplate Grip ✓
Co-ordinates:	Matrix location: (942) (943) (942) (943) U/L (944)	Hinge Bracket
Levels	Preservation:	Fixing nails Shroud pins
Slide No.	Neg No:	Fabric Other finds

Description E-W JUVENILE BURIAL. WOODEN COFFIN, HANDLE PRESENT. POSSIBLE PIECES OF SECOND SKULL INCLUDED. TRUNCATED AT LOWER LEGS (KNEES DOWN). TRACES OF WOOD. CW NOT SANDWICH.

Discussion ~~DISCUSSION~~  
TWO SKELETONS BARRIED TOGETHER (942) + (943)  
(942) SEEMS TO BE BELOW LARGER BURIAL (943), BUT STAY TOGETHER

Shape, dimensions and distinguishing characteristics  
BARRIED TOGETHER WITH (943)

LID

HEAD

BASE

Recorder: JM	Date: 14/11/00	Initials:
--------------	----------------	-----------

Site Code

Context

**Outer Coffin**

Sample Ret.

*Chloo*

*942*

Recording Date ..... *14/12/00* .....

Associated Numbers .....

Condition .....

Dep. Plate

Legible

Inscription

Fabric lead  ormolou  brass  tin plated pewter  gilt tin   
 iron  silvered tin  enamelled  other ..... Sample Ret.

**Shape of dep. plate**

square  rectangle  shield  tapered  lozenge   
 cartouche  oval  other .....

**Upholstery**

colour ..... shoddy  velvet  other ..... Sample Ret.

**Construction**

butt joint  mitred  pitched  other .....

**Grip plate**

Fabric = ormolou  brass  tin plated pewter  gilt tin   
*(2286)*

iron  *X1* silvered tin  enamelled  other ..... Sample Ret.

**Grip**

Fabric = ormolou  brass  iron  *X2* Sample Ret.   
*(2280)*

**Design**

swag of rose  horseshoe  cherub's head  plain

other .....

**Grip bolts**

**Corner bolts**  Type = gilt brass  brass  iron

other ..... Sample Ret.

**Lid motifs**

other ..... Sample Ret.

**Escutcheons**

other ..... Sample Ret.

**Upholstery**

*sheds*  brass  gilt brass  silvered brass  iron  enamelled

other ..... *1x price - 0% (small)* ..... Sample Ret.

**Fixings**

panel nails  screws  hinges  lace  Sample Ret.

**Timber type**

..... Sample Ret.

**Interpretation / Comments**

.....  
 .....

db.

SITE		COFFIN RECORD SHEET		CONTEXT NO.	
012.00				943	
Trench:		Additional sheets:		Treatment:	BENET LIFTED
Site sub-div:	se	Grave fills:		BURIED IN BAR WITH (942)	
Plan no:	6	Grave cut:		Finds:	None
Section no:		Skeleton:		Breastplate:	
Co-ordinates:		Matrix location:	(942) - (943) (942) + (943) v/l (944)	Hinge:	
Levels:		Preservation:		Bracket:	
Slide No.:		Neg No.:		Fixing nails:	
				Shroud pins:	X 1 alloy
				Fabric:	
				Other finds:	1 x <del>stud</del> stud (alloy)

**Description** E-W BURIAL. TOWER ADULT (?)  
 REVEALED HEAVY AT LOWER LIMBS. CONFUSED WITH (942),  
 TRACES OF WOOD, WOOD COFFIN.  
 POSSIBLE W/IN SANDWICH.

**Discussion**  
 (942) AND (943) BURIED TOGETHER, (942) SEEMS TO BE  
 POSITIONED BELOW (943)

Shape, dimensions and distinguishing characteristics

BURIED TOGETHER WITH (942)

LID

HEAD

BASE

Recorder:	DM	Date:	14/11/00	Initials:	
-----------	----	-------	----------	-----------	--

db.

SITE OLR 00	COFFIN RECORD SHEET	CONTEXT NO. 944
Trench:	Additional sheets: YES X1	Treatment: BONES LIFTED
Site sub-div: SE	Grave fills	
Plan no: 6	Grave cut:	Finds None
Section no:	Skeleton:	Breastplate Grip ✓
Co-ordinates:	Matrix location: <div style="display: flex; justify-content: space-around; align-items: center;"> <div style="text-align: center;">(941) 9/2 (944)</div> <div style="text-align: center;">(941) + (944)</div> <div style="text-align: center;">(944) 10/2 (942) (943)</div> </div>	Hinge Bracket
Levels	Preservation:	Fixing nails Shroud pins
Slide No.	Neg No:	Fabric Other finds

**Description** E-W ORIENTATED. WOOD COFFIN. HANDS PRESENT. PROBABLY TRUNATED LOWER PART OF BURIAL (942) (943)

**Discussion** POSSIBLY SOME MIXING WITH UNDERLYING BURIAL (945) AS VERY CLOSE TOGETHER,

Shape, dimensions and distinguishing characteristics

LID

HEAD

BASE

Recorder: DM	Date: 14/11/00	Initials:
--------------	----------------	-----------

# Coffin Recording Sheet

Site Code

Context

**Outer Coffin**

Sample Ret.

OKR00

944

Recording Date ..... 12/12/00

Associated Numbers .....

Condition .....

Dep. Plate

Legible

Inscription

**Fabric** lead  ormolou  brass  tin plated pewter  gilt tin   
 iron  silvered tin  enamelled  other ..... Sample Ret.

**Shape of dep. plate**

square  rectangle  shield  tapered  lozenge   
 cartouche  oval  other .....

**Upholstery**

colour ..... shoddy  velvet  other ..... Sample Ret.

**Construction**

butt joint  mitred  pitched  other .....

**Grip plate**

Fabric = ormolou  brass  tin plated pewter  gilt tin   
*frags on rev of grip*  
 iron  silvered tin  enamelled  other ..... Sample Ret.

**Grip**

Fabric = ormolou  brass  iron  *XA* Sample Ret.

**Design**

swag of rose  horseshoe  cherub's head  *black enameled*  plain

other .....

**Grip bolts**

**Corner bolts**  **Type =** gilt brass  brass  iron

other ..... Sample Ret.

**Lid motifs**

other ..... Sample Ret.

**Escutcheons**

other ..... Sample Ret.

**Upholstery nails**

brass  gilt brass  silvered brass  iron  enamelled

other ..... Sample Ret.

**Fixings**

panel nails  screws  hinges  lace  Sample Ret.

**Timber type**

..... Sample Ret.

**Interpretation / Comments**

.....  
 .....

db.

SITE		COFFIN RECORD SHEET		CONTEXT NO.	
OR 08				945	
Trench:		Additional sheets: YES X1		Treatment: BONES LIFTED	
Site sub-div: se		Grave fills			
Plan no: 6		Grave cut:		Finds	
				None	
Section no:		Skeleton:		Breastplate	
				Grip ✓	
Co-ordinates:		Matrix location: (944) o/L (945) (945) u/L (944)		Hinge	
				Bracket	
Levels		Preservation:		Fixing nails	
				Shroud pins	
Slide No.		Neg No:		Fabric	
				Other finds	
<p>Description E-W. JUVENILE BURIAL. TOP HALF MOSTLY MISSING, PROBABLY TRUNCEATED BY (944). ONLY RIGHT ARM PRESENT FROM TOP HALF. WOOD COFFIN. W/ ANONY SANDWICH, HANDLE</p> <p>Discussion POSSIBLY SOME MIXING WITH OVERLYING BURIAL (944) AS VERY CLOSE TOGETHER.</p>					
<p>Shape, dimensions and distinguishing characteristics</p> <p>LID</p> <p>HEAD</p> <p>BASE</p>					
Recorder: DM		Date: 14/11/00		Initials:	



# Coffin Recording Sheet

Site Code

Context

**Outer Coffin**

Sample Ret.

ohloo

9A5

Recording Date ..... 13/12/00

Associated Numbers .....

Condition .....

Dep. Plate

Legible

Inscription

**Fabric** lead  ormolou  brass  tin plated pewter  gilt tin   
iron  silvered tin  enamelled  other ..... Sample Ret.

**Shape of dep. plate**

square  rectangle  shield  tapered  lozenge   
cartouche  oval  other .....

**Upholstery**

colour ..... shoddy  velvet  other ..... Sample Ret.

**Construction**

butt joint  mitred  pitched  other .....

**Grip plate**  **Fabric =** ormolou  brass  tin plated pewter  gilt tin   
iron  silvered tin  enamelled  other ..... Sample Ret.

**Grip**  **Fabric =** ormolou  brass  iron  *mid.* Sample Ret.

**Design** swag of rose  horseshoe  cherub's head  plain   
other .....

**Grip bolts**  **Corner bolts**  **Type =** gilt brass  brass  iron   
other ..... Sample Ret.

**Lid motifs**  other ..... Sample Ret.

**Escutcheons**  other ..... Sample Ret.

**Upholstery** *skuds* nails  brass  gilt brass  silvered brass  iron  enamelled   
other ..... *1 x piece*  Sample Ret.

**Fixings**  panel nails  screws  hinges  lace  Sample Ret.

**Timber type** ..... Sample Ret.

**Interpretation / Comments**

.....  
.....

SITE		COFFIN RECORD SHEET		CONTEXT NO.	
0LR-08				946	
Trench:		Additional sheets:		Treatment: Bones / DNA collected	
Site sub-div: SC		Grave fills:			
Plan no: 6		Grave cut:		Finds	
				None	
Section no:		Skeleton:		Breastplate ✓	
				Grip ✓	
Co-ordinates:		Matrix location: under & slightly to the north of burial (945)		Hinge	
				Bracket	
Levels:		Preservation: Bones - reasonable preservation Coffin - decayed		Fixing nails	
				Shroud pins	
Slide No.:		Neg No.:		Fabric	
				Other finds	
Description: E-W Burial in wood coffin - traces of wood / shd work / grips seen: well preserved lead, breastplate.					
Discussion					
Shape, dimensions and distinguishing characteristics					
Lead breastplate inscription:-					
LID					
Mrs Lydia Batty Died 22 Aug 1812 In her 54 <sup>th</sup> year.					
HEAD					
BASE					
Recorder: DS		Date: 14/11		Initials:	

Site Code

Context

**Outer Coffin**

Sample Ret.

06200

946

Recording Date ..... 20/2/01 .....

Associated Numbers .....

Condition ..... 3 .....

Dep. Plate

Legible

Inscription "Mrs Lydia Betty/Died 22<sup>nd</sup> Aug<sup>st</sup> 1812/ In her 54<sup>th</sup> Year"

82 w/ 1132 border - plain outer

Fabric lead  ormolou  brass  tin plated pewter  gilt tin   
 iron  silvered tin  enamelled  other ..... Sample Ret.

black polished

**Shape of dep. plate**

square  rectangle  shield  tapered  lozenge   
 cartouche  oval  other .....

**Upholstery**

colour ..... shoddy  velvet  other ..... Sample Ret.

**Construction**

butt joint  mitred  pitched  other .....

**Grip plate**

Fabric = ormolou  brass  tin plated pewter  gilt tin

iron  <sup>Frogs of 7</sup> silvered tin  enamelled  other ..... Sample Ret.

black

**Grip**

Fabric = ormolou  brass  iron  x2 Sample Ret.

**Design**

swag of rose  horseshoe  cherub's head  plain

1's

other .....

**Grip bolts**

**Corner bolts**  Type = gilt brass  brass  iron

other ..... Sample Ret.

**Lid motifs**

other ..... Sample Ret.

**Escutcheons**

other ..... Sample Ret.

**Upholstery**

<sup>studs</sup> ~~nails~~  brass  gilt brass  silvered brass  iron  enamelled

other ..... 1 x 000 = 3 ..... Sample Ret.

**Fixings**

panel nails  screws  hinges  lace  Sample Ret.

**Timber type**

Sample Ret.

**Interpretation / Comments**

.....  
 .....

db.

SITE	0CR00	COFFIN RECORD SHEET	CONTEXT NO.	947	
Trench:		Additional sheets:	YES x1	Treatment:	BOXES LIFTED
Site sub-div:	SC	Grave fills			
Plan no:	6	Grave cut:		Finds	None
Section no:		Skeleton:		Breastplate	
Co-ordinates:		Matrix location:	(947) o/L (952) (952) u/L (947)	Hinge	
Levels		Preservation:	GOOD	Bracket	
Slide No.		Neg No:		Fixing nails	
				Shroud pins	
				Fabric	
				Other finds	

Description E-W ADULT BURIAL. WOODEN COFFIN.  
HEAD HANDLE PRESENT.

Discussion

Shape, dimensions and distinguishing characteristics

LID

HEAD

BASE

Recorder:	DM	Date:	14/11/00	Initials:	
-----------	----	-------	----------	-----------	--

# Coffin Recording Sheet

Site Code

Context

**Outer Coffin**

Sample Ret.

0H200

947

Recording Date ..... 6/12/00 .....

Associated Numbers .....

Condition .....

Dep. Plate

Legible

Inscription

**Fabric** lead  ormolou  brass  tin plated pewter  gilt tin   
iron  silvered tin  enamelled  other ..... Sample Ret.

**Shape of dep. plate**

square  rectangle  shield  tapered  lozenge   
cartouche  oval  other .....

**Upholstery**

colour ..... shoddy  velvet  other ..... Sample Ret.

**Construction**

butt joint  mitred  pitched  other .....

**Grip plate**

Fabric = ormolou  brass  tin plated pewter  gilt tin   
*Feugs on rev of grip - unid.*  
 iron  silvered tin  enamelled  other ..... Sample Ret.

**Grip**

Fabric = ormolou  brass  iron  x2 Sample Ret.

**Design**

swag of rose  horseshoe  cherub's head  20 15 plain

other .....

**Grip bolts**

**Corner bolts**  Type = gilt brass  brass  iron

other ..... Sample Ret.

**Lid motifs**

other ..... Sample Ret.

**Escutcheons**

other ..... Sample Ret.

**Upholstery nails**

brass  gilt brass  silvered brass  iron  enamelled

other ..... Sample Ret.

**Fixings**

panel nails  screws  hinges  lace  Sample Ret.

**Timber type**

Sample Ret.

**Interpretation / Comments**

*1 x cu alloy shroud pin*

Nb.

SITE: <u>OUR 00</u>	COFFIN RECORD SHEET	CONTEXT NO.: <u>948</u>
Trench:	Additional sheets: <u>YES x1.</u>	Treatment: <u>BONES LIFTED</u>
Site sub-div: <u>SC</u>	Grave fills	
Plan no: <u>6</u>	Grave cut:	Finds None
Section no:	Skeleton:	Breastplate Grip
Co-ordinates:	Matrix location: <u>(948) or (949)</u>	Hinge Bracket
Levels	Preservation: 	Fixing nails Shroud pins
Slide No.	Neg No:	Fabric Other finds

Description E-W BURIAL. WOODEN COFFIN. ADULT.  
HAS TRUNCATED BURIAL ~~UNDER~~ UNDERNEATH - (949).  
POSSIBLE MIXING OF BONES WITH (949) AS BURIALS  
 Discussion VERY CLOSE TOGETHER.  
FE STUDWORK FOR EITHER (948) OR (949) OR BOTH.

Shape, dimensions and distinguishing characteristics

LID

HEAD

BASE

Additional bones:  
 R head + neck of femur  
 L. head of femur  
 Fragments of sacrum  
 Left anterior part of maxilla  
 Teeth C, Pm 1+2 in situ.

} 949?

Recorder: <u>DM</u>	Date: <u>14/11/00</u>	Initials:
---------------------	-----------------------	-----------

**Outer Coffin**

Sample Ret.

Site Code

Context

Recording Date ..... 12/12/00 .....

OR200

9458

Associated Numbers .....

Condition .....

Dep. Plate

Legible

Inscription

**Fabric** lead  ormolou  brass  tin plated pewter  gilt tin   
 iron  silvered tin  enamelled  other ..... Sample Ret.

**Shape of dep. plate**

square  rectangle  shield  tapered  lozenge   
 cartouche  oval  other .....

**Upholstery**

colour ..... shoddy  velvet  other ..... Sample Ret.

**Construction**

butt joint  mitred  pitched  other .....

**Grip plate**  Fabric = ormolou  brass  tin plated pewter  gilt tin   
 iron  silvered tin  enamelled  other ..... Sample Ret.

**Grip**  Fabric = ormolou  brass  iron  <sup>x1</sup> Sample Ret.

**Design** swag of rose  horseshoe  cherub's head  (36) plain   
 other .....

**Grip bolts**  **Corner bolts**  **Type =** gilt brass  brass  iron   
 other ..... Sample Ret.

**Lid motifs**  other ..... Sample Ret.

**Escutcheons**  other ..... Sample Ret.

**Upholstery nails**  brass  gilt brass  silvered brass  iron  enamelled   
 other ..... Sample Ret.

**Fixings**  panel nails  screws  hinges  lace  Sample Ret.

**Timber type** ..... Sample Ret.

**Interpretation / Comments**

.....  
 .....

db.

SITE <b>OR 00</b>	COFFIN RECORD SHEET	CONTEXT NO. <b>949</b>
Trench:	Additional sheets: <b>YES x1.</b>	Treatment: <b>BONES LIFTED</b>
Site sub-div: <b>SC</b>	Grave fills	
Plan no: <b>6</b>	Grave cut:	Finds None
Section no:	Skeleton:	Breastplate Grip
Co-ordinates:	Matrix location: <b>(948) o/L (949)</b> <b>(949)</b>	Hinge Bracket
Levels	Preservation:	Fixing nails Shroud pins
Slide No.	Neg No:	Fabric Other finds

**Description** E-W ADULT BURIAL, TRUNCATED AT TOP BY OVERTURNING **(948)**. POSSIBLE MIXING OF BONES BETWEEN **(948)** AND **(949)** AS BURIALS VERY CLOSE.

**Discussion** WOODEN COFFIN, FE STUDWORK EITHER FOR **(948)** OR **(949)** OR BOTH.

Shape, dimensions and distinguishing characteristics

LID

HEAD

BASE

Recorder: <b>DM</b>	Date: <b>14/11/00</b>	Initials:
---------------------	-----------------------	-----------



Site Code

Context

**Outer Coffin**

Sample Ret.

*2200*

*949*

Recording Date ..... *13/12/00* .....

Associated Numbers .....

Condition .....

Dep. Plate

Legible

Inscription

**Fabric** lead  ormolou  brass  tin plated pewter  gilt tin   
 iron  silvered tin  enamelled  other ..... Sample Ret.

**Shape of dep. plate**

square  rectangle  shield  tapered  lozenge   
 cartouche  oval  other .....

**Upholstery**

colour ..... shoddy  velvet  other ..... Sample Ret.

**Construction** butt joint  mitred  pitched  other .....

**Grip plate**  Fabric = ormolou  brass  tin plated pewter  gilt tin   
*Feeds on rev of grip. - unid.*  
 iron  silvered tin  enamelled  other ..... Sample Ret.

**Grip**  Fabric = ormolou  brass  iron  *XI* Sample Ret.

**Design** swag of rose  horseshoe  cherub's head  *(3b)* plain   
 other .....

**Grip bolts**  **Corner bolts**  **Type =** gilt brass  brass  iron   
 other ..... Sample Ret.

**Lid motifs**  other ..... Sample Ret.

**Escutcheons**  other ..... Sample Ret.

**Upholstery nails**  brass  gilt brass  silvered brass  iron  enamelled   
 other ..... Sample Ret.

**Fixings**  panel nails  screws  hinges  lace  Sample Ret.

**Timber type** ..... Sample Ret.

**Interpretation / Comments**

.....  
 .....

db.

SITE OLR 00	COFFIN RECORD SHEET	CONTEXT NO. 950
Trench:	Additional sheets: YES x1-	Treatment: BONES LIFTED
Site sub-div: Se	Grave fills	
Plan no: 6	Grave cut:	Finds None
Section no:	Skeleton:	Breastplate Grip <input checked="" type="checkbox"/>
Co-ordinates:	Matrix location: 950 o/l 954 954 u/l 950	Hinge Bracket
Levels	Preservation: GOOD	Fixing nails Shroud pins
Slide No.	Neg No:	Fabric Other finds

Description E-W ADULT BURIAL. WOODEN COFFIN WITH  
OUTTER: Pb BREAST PLATE. BREAST PLATE TOO CORRODED TO  
BE READABLE. NO DNA SAMPLES TAKEN.  
TRUNCATED AT ANKLES -> FEET MISSING.

Discussion  
CW ALLOY STUDWORK. GRIPS PRESENT.

Shape, dimensions and distinguishing characteristics

LID

HEAD

BASE

Recorder: DM	Date: 14/11/00	Initials:
--------------	----------------	-----------

Site Code

Context

Outer Coffin

Sample Ret.

*0200*

*950*

Recording Date *19/12/00*

Associated Numbers

Condition *1*

Dep. Plate

Legible

Inscription *Mrs/Ann Riccardo/Died 27<sup>th</sup> Dec/1874/Aged 28 Years*

Fabric lead  ormolou  brass  tin plated pewter  gilt tin   
 iron  silvered tin  enamelled  other ..... Sample Ret.

*black polished*

*Splds ⑨ w/out outer board.*

Shape of dep. plate

square  rectangle  shield  tapered  lozenge   
 cartouche  oval  other .....

*has frags of black enamelled (Fe) plate adhering to sides. - lid motif frags?*

Upholstery

colour ..... shoddy  velvet  other ..... Sample Ret.

Construction

butt joint  mitred  pitched  other .....

Grip plate

Fabric = ormolou  brass  tin plated pewter  gilt tin   
 iron  silvered tin  enamelled  other ..... Sample Ret.

*Frags on rev of grip-wood.*

Grip

Fabric = ormolou  brass  iron  *x2* Sample Ret.

Design

swag of rose  horseshoe  cherub's head  *④'s* plain

other .....

Grip bolts

Corner bolts  Type = gilt brass  brass  iron

other ..... Sample Ret.

Lid motifs

other ..... Sample Ret.

Escutcheons

other ..... Sample Ret.

Upholstery *sheds nails*

brass  gilt brass  silvered brass  iron  *x2* enamelled

other ..... Sample Ret.

Fixings

panel nails  screws  hinges  lace  Sample Ret.

Timber type

Sample Ret.

Interpretation / Comments

.....  
 .....

SITE <u>AL 00</u>		COFFIN RECORD SHEET		CONTEXT NO. <u>951</u>	
Trench:		Additional sheets:		Treatment:	<u>SCREWS LIFTED</u>
Site sub-div:	<u>SE</u>	Grave fills:		Finds:	None
Plan no:	<u>6</u>	Grave cut:		Breastplate:	
Section no:		Skeleton:		Grip:	<input checked="" type="checkbox"/>
Co-ordinates:		Matrix location:	<u>952</u> <u>OR</u> <u>951</u> <u>951</u> <u>SL</u> <u>952</u>	Hinge:	
Levels:		Preservation:		Bracket:	
Slide No.:		Neg No.:		Fixing nails:	
				Shroud pins:	
				Fabric:	
				Other finds:	
<p>Description <u>E-W Pb-COFFIN. ADULT. COFFIN MACHINED OUT AS TOO NEAR TO VERY HIGH AND UNSURE SECTION. RECORDED IN PLAN, BUT MEASUREMENTS OF THE COFFIN HAVE NOT BEEN TAKEN. OUTER BREASTPLATE PRESENT AS WELL AS SOLDERED COFFIN PLATE BUT NEITHER RELEASABLE. HAD AN <del>INFANT</del> INFANT BURIAL ON TOP OF IT - <u>952</u></u></p>					
<p>Shape, dimensions and distinguishing characteristics</p> <p>LID</p> <p>HEAD</p> <p>BASE</p>					
Recorder:	<u>DM</u>	Date:	<u>15/11/00</u>	Initials:	

**Outer Coffin**

Sample Ret.

Site Code

OLR00

Context

951

Recording Date ..... 16/2/01 .....

Associated Numbers .....

Condition .....

Dep. Plate

Legible

Inscription "Mr / John Stubbs / Died 7th Nov / 1811 / Aged 74 Years"

same as 340

Fabric lead  ormolou  brass  tin plated pewter  gilt tin   
iron  silvered tin  enamelled  other ..... Sample Ret.

**Shape of dep. plate**

square  rectangle  shield  tapered  lozenge   
cartouche  oval  other .....

**Upholstery**

colour ..... shoddy  velvet  other ..... Sample Ret.

**Construction**

butt joint  mitred  pitched  other .....

Grip plate  Fabric = ormolou  brass  tin plated pewter  gilt tin   
iron  silvered tin  enamelled  other ..... Sample Ret.

Grip  Fabric = ormolou  brass  iron  x4 Sample Ret.

Design swag of rose  horseshoe  cherub's head  plain  (4)5  
other .....

Grip bolts  Corner bolts  Type = gilt brass  brass  iron   
other ..... Sample Ret.

Lid motifs  other ..... Sample Ret.

Escutcheons  other ..... Sample Ret.

Upholstery nails  brass  gilt brass  silvered brass  iron  enamelled   
other ..... Sample Ret.

Fixings  panel nails  screws  hinges  lace  Sample Ret.

Timber type ..... Sample Ret.

**Interpretation / Comments**

.....  
.....

SITE OLR 00	COFFIN RECORD SHEET	CONTEXT NO. 952
Trench:	Additional sheets:	Treatment: BONES LIFTED
Site sub-div: SC	Grave fills:	
Plan no: 6	Grave cut:	Finds None
Section no:	Skeleton:	Breastplate Grip
Co-ordinates:	Matrix location: (952) qL (951) (951) v/L (952)	Hinge Bracket
Levels:	Preservation:	Fixing nails Shroud pins
Slide No.:	Neg No.:	Fabric Other finds

**Description** E-W INFANT BURIAL SITTING ON TOP OF Pb-COFFIN (951). WOODEN COFFIN. BURIAL MACHINED OUT AS TOO NEAR TO INSECURE HIGH SECTION TO BE EXCAVATED MANUALLY.

**Discussion**

**Shape, dimensions and distinguishing characteristics**

LID

HEAD

BASE

Recorder: DM	Date: 15/11/00	Initials:
-----------------	-------------------	-----------

SITE		COFFIN RECORD SHEET		CONTEXT NO.	
OUR 00				953	
Trench:		Additional sheets: 468 x 1		Treatment: BONES LIFTED	
Site sub-div: SC		Grave fills			
Plan no: C		Grave cut:		Finds	
				None	
Section no:		Skeleton:		Breastplate	
				Grip	
Co-ordinates:		Matrix location: (951) OL (953) (953)		Hinge	
				Bracket	
Levels		Preservation:		Fixing nails	
				Shroud pins	
Slide No:		Neg No:		Fabric	
				Other finds	
				:	
Description E-W ADULT BURIAL WOODEN COFFIN. BURIAL MARKED OUT AS TOO NEAR HIGH INSURE SECTION.					
Discussion					
Shape, dimensions and distinguishing characteristics					
LID					
HEAD					
BASE					
Recorder: DM		Date: 15/11/00		Initials:	

Site Code

Context

**Outer Coffin**

Sample Ret.

OH200

953

Recording Date ..... 14/2/01 .....

Associated Numbers .....

Condition .....

Dep. Plate

Legible

Inscription

**Fabric** lead  ormolou  brass  tin plated pewter  gilt tin   
iron  silvered tin  enamelled  other ..... Sample Ret.

**Shape of dep. plate**

square  rectangle  shield  tapered  lozenge   
cartouche  oval  other .....

**Upholstery**

colour ..... shoddy  velvet  other ..... Sample Ret.

**Construction**

butt joint  mitred  pitched  other .....

**Grip plate**  Fabric = ormolou  brass  tin plated pewter  gilt tin   
iron  *frag on rev of grip-und.* silvered tin  enamelled  other ..... Sample Ret.

**Grip**  Fabric = ormolou  brass  iron  x 2 Sample Ret.

**Design** swag of rose  horseshoe  cherub's head  plain   
other ..... *1 x ↓ 0.135 ↔ 0.045 / 1 x ↓ 0.16 ↔ 0.055, (4)5*

**Grip bolts**  **Corner bolts**  **Type =** gilt brass  brass  iron

other ..... Sample Ret.

**Lid motifs**  other ..... Sample Ret.

**Escutcheons**  other ..... Sample Ret.

**Upholstery nails**  brass  gilt brass  silvered brass  iron  enamelled

other ..... Sample Ret.

**Fixings**  panel nails  screws  hinges  lace  Sample Ret.

**Timber type** ..... Sample Ret.

**Interpretation / Comments**

.....  
.....



SITE	OLR 00	COFFIN RECORD SHEET	CONTEXT NO.	954
Trench:		Additional sheets:	Treatment:	BONES LIFTED
Site sub-div:	3C	Grave fills		
Plan no:	6	Grave cut:	Finds	None
Section no:		Skeleton:	Breastplate	
			Grip	
Co-ordinates:		Matrix location:	Hinge	
		(950) 9L (954)	Bracket	
		(954) U/L (950)	Fixing nails	
Levels		Preservation:	Shroud pins	
Slide No.		Neg No:	Fabric	
			Other finds	
<p>Description E-W INFANT BURIAL, WOODEN COFFIN, BURIAL MACHINED OUT AS TOO NEAR JURY HIGH INSECURE SECTION.</p>				
Discussion				
Shape, dimensions and distinguishing characteristics				
LID				
HEAD				
BASE				
Recorder:	DM	Date:	15/11/00	Initials:

SITE 02200	COFFIN RECORD SHEET	CONTEXT NO. 955
Trench:	Additional sheets: YES x 1	Treatment: BONES LIFTED
Site sub-div: SC	Grave fills	
Plan no: 6	Grave cut:	Finds None
Section no:	Skeleton:	Breastplate Grip
Co-ordinates:	Matrix location: 955	Hinge Bracket
Levels	Preservation:	Fixing nails Shroud pins
Slide No.	Neg No:	Fabric Other finds

Description E-W INFANT BURIAL WOODEN COFFIN.  
Fe STUDWORK.

Discussion

Shape, dimensions and distinguishing characteristics

LID

HEAD

BASE

Recorder: DM	Date: 15/11/00	Initials:
--------------	----------------	-----------

# Coffin Recording Sheet

Site Code

Context

**Outer Coffin**

Sample Ret.

04100

955

Recording Date ..... 13/2/01 .....

Associated Numbers .....

Condition .....

Dep. Plate

Legible

Inscription

Fabric lead  ormolou  brass  tin plated pewter  gilt tin   
 iron  silvered tin  enamelled  other ..... Sample Ret.

**Shape of dep. plate**

square  rectangle  shield  tapered  lozenge   
 cartouche  oval  other .....

**Upholstery**

colour ..... shoddy  velvet  other ..... Sample Ret.

**Construction**

butt joint  mitred  pitched  other .....

**Grip plate**  Fabric = ormolou  brass  tin plated pewter  gilt tin   
 iron  silvered tin  enamelled  other ..... Sample Ret.

**Grip**  Fabric = ormolou  brass  iron  Sample Ret.

**Design** swag of rose  horseshoe  cherub's head  plain   
 other .....

**Grip bolts**  **Corner bolts**  **Type =** gilt brass  brass  iron   
 other ..... Sample Ret.

**Lid motifs**  other ..... Sample Ret.

**Escutcheons**  other ..... Sample Ret.

**Upholstery** <sup>studs</sup> ~~nails~~  brass  gilt brass  silvered brass  iron  enamelled   
 other ..... 1 x piece oo ..... Sample Ret.

**Fixings**  panel nails  screws  hinges  lace  Sample Ret.

**Timber type** ..... Sample Ret.

**Interpretation / Comments**

.....  
 .....

db.

SITE	OLR 00	COFFIN RECORD SHEET	CONTEXT NO.	956
Trench:		Additional sheets:	Treatment:	BONES LIFTED
Site sub-div:	SC	Grave fills		
Plan no:	6	Grave cut:	Finds	None
Section no:		Skeleton:	Breastplate	
			Grip	
Co-ordinates:		Matrix location:	Hinge	
		(956) d (957)	Bracket	
		(957) o/c (958)	Fixing nails	
Levels		Preservation:	Shroud pins	✓ x1
Slide No.		Neg No:	Fabric	shroud fabric
			Other finds	2 x Fe stud.

Description E-W ADULT BURIAL. WOODEN COFFIN.  
 W/ METAL STUDWORK. BURIAL VERY CLOSE TO BURIALS  
 (957) AND (958) AND SHOULD BE ANALYSED TOGETHER  
 Discussion WITH THEM DUE TO POSSIBLE MIXING.

Shape, dimensions and distinguishing characteristics

LID

HEAD

BASE

Extra bones:  
 R. Radius  
 L. Patella  
 L. Calcaneus  
 R. Cuboid  
 R. Medial cuneiform  
 R. 1st & 2nd Mt  
 L+R 2nd MC  
 R. 3rd MC  
 L+R Iliac blade fragments

All adult - bones of 2 individuals -  
 957 + 958

Recorder:	JM	Date:	15/11/00	Initials:	
-----------	----	-------	----------	-----------	--

db.

SITE OLR 00	COFFIN RECORD SHEET	CONTEXT NO. 957
Trench:	Additional sheets: <u>UESX1.</u>	Treatment: <u>BONES LIFTED</u>
Site sub-div: <u>SE</u>	Grave fills	
Plan no: <u>6</u>	Grave cut:	Finds None
Section no:	Skeleton:	Breastplate Grip
Co-ordinates:	Matrix location: <u>956</u> <u>9L</u> <u>957</u> <u>957</u> <u>0/L</u> <u>958</u> <u>958</u> <u>U/L</u> <u>957</u>	Hinge Bracket
Levels	Preservation:	Fixing nails Shroud pins
Slide No.	Neg No:	Fabric Other finds
<p>Description <u>E-W ADULT BURIAL, WOODEN COFFIN. CW ANDY STRUCK. BURIAL LOCATED VERY CLOSE TO OVERLYING <u>956</u> AND UNDERLYING <u>958</u>. SHOULD BE LOOKED AT TOGETHER WITH THEM BECAUSE OF POSSIBLE MIXING.</u></p> <p>Discussion</p>		
<p>Shape, dimensions and distinguishing characteristics</p> <p>Extra bones: R. Ulna Manubrium Left Ischium, pubis + acetabulum Right Ischial tuberosity Sacral fragment</p> <p>LID</p> <p>HEAD</p> <p>BASE</p> <p>From <u>956</u> or <u>958</u></p> <p>} same individual</p>		
Recorder: <u>DM</u>	Date: <u>15/11/00</u>	Initials:

# Coffin Recording Sheet

Site Code

Context

OKR00

957

**Outer Coffin**

Sample Ret.

Recording Date ..... 8/12/00 .....

Associated Numbers .....

Condition .....

Dep. Plate

Legible

Inscription

Fabric lead  ormolou  brass  tin plated pewter  gilt tin   
 iron  silvered tin  enamelled  other ..... Sample Ret.

**Shape of dep. plate**

square  rectangle  shield  tapered  lozenge   
 cartouche  oval  other .....

**Upholstery**

colour ..... shoddy  velvet  other Booze ..... Sample Ret.

**Construction**

butt joint  mitred  pitched  other .....

**Grip plate**

Fabric = ormolou  brass  tin plated pewter  gilt tin   
 iron  silvered tin  enamelled  other ..... Sample Ret.   
*kegs on rev of grip - unid.*

**Grip**

Fabric = ormolou  brass  iron  Sample Ret.   
*too conc. to id.*

**Design**

swag of rose  horseshoe  cherub's head  plain

other .....

**Grip bolts**

**Corner bolts**  Type = gilt brass  brass  iron

other ..... Sample Ret.

**Lid motifs**

other ..... Sample Ret.

**Escutcheons**

other ..... Sample Ret.

**Upholstery**

*studs*  
 nails  brass  gilt brass  silvered brass  iron  enamelled   
 other *diagnostic pieces* ..... Sample Ret.   
*105 studs in total.*

**Fixings**

panel nails  screws  hinges  lace  Sample Ret.

**Timber type** .....

Sample Ret.

**Interpretation / Comments**

.....  
 .....

SITE OLR 00	COFFIN RECORD SHEET	CONTEXT NO. 958
Trench:	Additional sheets: <i>WES X1</i>	Treatment: <i>BONES LIFTED</i>
Site sub-div: <i>SC</i>	Grave fills	
Plan no: <i>6</i>	Grave cut:	Finds None
Section no:	Skeleton:	Breastplate Grip
Co-ordinates:	Matrix location: <i>(957) q (958)</i> <i>(958) u/l (987)</i>	Hinge Bracket
Levels	Preservation:	Fixing nails Shroud pins
Slide No.	Neg No:	Fabric Other finds
<p>Description <i>E-W ADULT BURIAL. WOODEN COFFIN. CW-ALLOY SMDWORK. BURIAL LOCATED VERY CLOSE TO ORIENTING BURIALS (956) AND (957) IT SHOULD BE LOOKED AT IN CONJUNCTION WITH THESE</i></p> <p>Discussion <i>N/A BECAUSE OF POSSIBLE MIXING.</i></p>		
<p>Shape, dimensions and distinguishing characteristics</p> <p>LID</p> <p>HEAD</p> <p>BASE</p>		
Recorder: <i>DM</i>	Date: <i>25/1/00</i>	Initials:

# Coffin Recording Sheet

**Outer Coffin**

Sample Ret.

Site Code

Context

Recording Date ..... 13/2/01 .....

OH100

958

Associated Numbers .....

Condition .....

Dep. Plate

Legible

Inscription

Fabric lead  ormolou  brass  tin plated pewter  gilt tin   
 iron  silvered tin  enamelled  other ..... Sample Ret.

**Shape of dep. plate**

square  rectangle  shield  tapered  lozenge   
 cartouche  oval  other .....

**Upholstery**

colour ..... shoddy  velvet  other ..... Sample Ret.

**Construction**

butt joint  mitred  pitched  other .....

**Grip plate**

*Fabric = ormolou*  brass  tin plated pewter  gilt tin   
*irons on rev of grip - unid.*  
 iron  silvered tin  enamelled  other ..... Sample Ret.

**Grip**

*Fabric = ormolou*  brass  iron  x2 Sample Ret.

**Design**

swag of rose  horseshoe  cherub's head  (3b)'s plain

other .....

**Grip bolts**

**Corner bolts**  Type = gilt brass  brass  iron

other ..... Sample Ret.

**Lid motifs**

other ..... Sample Ret.

**Escutcheons**

other ..... Sample Ret.

**Upholstery nails**

brass  gilt brass  silvered brass  iron  enamelled

other ..... Sample Ret.

**Fixings**

panel nails  screws  hinges  lace  Sample Ret.

**Timber type** .....

Sample Ret.

**Interpretation / Comments**

.....  
 .....



SITE <u>our 00</u>		COFFIN RECORD SHEET		CONTEXT NO. <u>959</u>	
Trench:		Additional sheets: <u>468 x 1</u>		Treatment: <u>BONES LIFTED</u>	
Site sub-div: <u>se</u>		Grave fills			
Plan no: <u>6</u>		Grave cut:		Finds None	
Section no:		Skeleton:		Breastplate Grip <input checked="" type="checkbox"/>	
Co-ordinates:		Matrix location: <u>959</u> o/l <u>993</u> <u>993</u> u/l <u>959</u>		Hinge Bracket	
Levels		Preservation:		Fixing nails Shroud pins	
Slide No.		Neg No:		Fabric Other finds	

Description E-W ADULT BURIAL, WOODEN COFFIN  
GRIP PRESENT & GRIP-PLATE  
CU-ALLOY COIN  FOUND WITHIN FM OF GRAVE (959) ABOUT  
Discussion 0.20m ABOVE THE SKULL.

Shape, dimensions and distinguishing characteristics

LID

HEAD

BASE

Recorder: <u>DM</u>	Date: <u>15/11/00</u>	Initials:
---------------------	-----------------------	-----------

Site Code

Context

OLR00

959

**Outer Coffin**

Sample Ret.

Recording Date ..... 13/2/01 .....

Associated Numbers .....

Condition .....

Dep. Plate

Legible

Inscription

Fabric lead  ormolou  brass  tin plated pewter  gilt tin   
 iron  silvered tin  enamelled  other ..... Sample Ret.

**Shape of dep. plate**

square  rectangle  shield  tapered  lozenge   
 cartouche  oval  other .....

**Upholstery**

colour ..... shoddy  velvet  other ..... Sample Ret.

**Construction**

butt joint  mitred  pitched  other .....

Grip plate  Fabric = ormolou  brass  tin plated pewter  gilt tin   
 iron  silvered tin  enamelled  other ..... Sample Ret.   
*Flegs - trumpet - some 30 486 cord block*

Grip  Fabric = ormolou  brass  iron  Sample Ret.   
*(20)15*

Design swag of rose  horseshoe  cherub's head  plain   
 other ..... *1x ↔ 0.14 ↓ 0.05 / 1x ↔ 0.11 ↓ 0.04.*

Grip bolts  Corner bolts  Type = gilt brass  brass  iron   
 other ..... Sample Ret.

Lid motifs  other ..... Sample Ret.

Escutcheons  other ..... Sample Ret.

Upholstery nails  brass  gilt brass  silvered brass  iron  enamelled   
 other ..... Sample Ret.

Fixings  panel nails  screws  hinges  lace  Sample Ret.

Timber type ..... Sample Ret.

**Interpretation / Comments**

.....  
 .....

db.

SITE OLR00	COFFIN RECORD SHEET	CONTEXT NO. <del>926</del> 960
Trench: CRYPT	Additional sheets:	Treatment: → NECRIP.
Site sub-div: BOY3	Grave fills:	
Plan no: 7	Grave cut:	Finds None
Section no:	Skeleton:	Breastplate Grip
Co-ordinates:	Matrix location: adj to 926 U/L 360	Hinge Bracket
Levels:	Preservation: SQUARED BUT GOOD.	Fixing nails Shroud pins
Slide No.:	Neg No.:	Fabric Other finds:

Description  
E → W adult p.b. coffin  
NO NAME.

Discussion

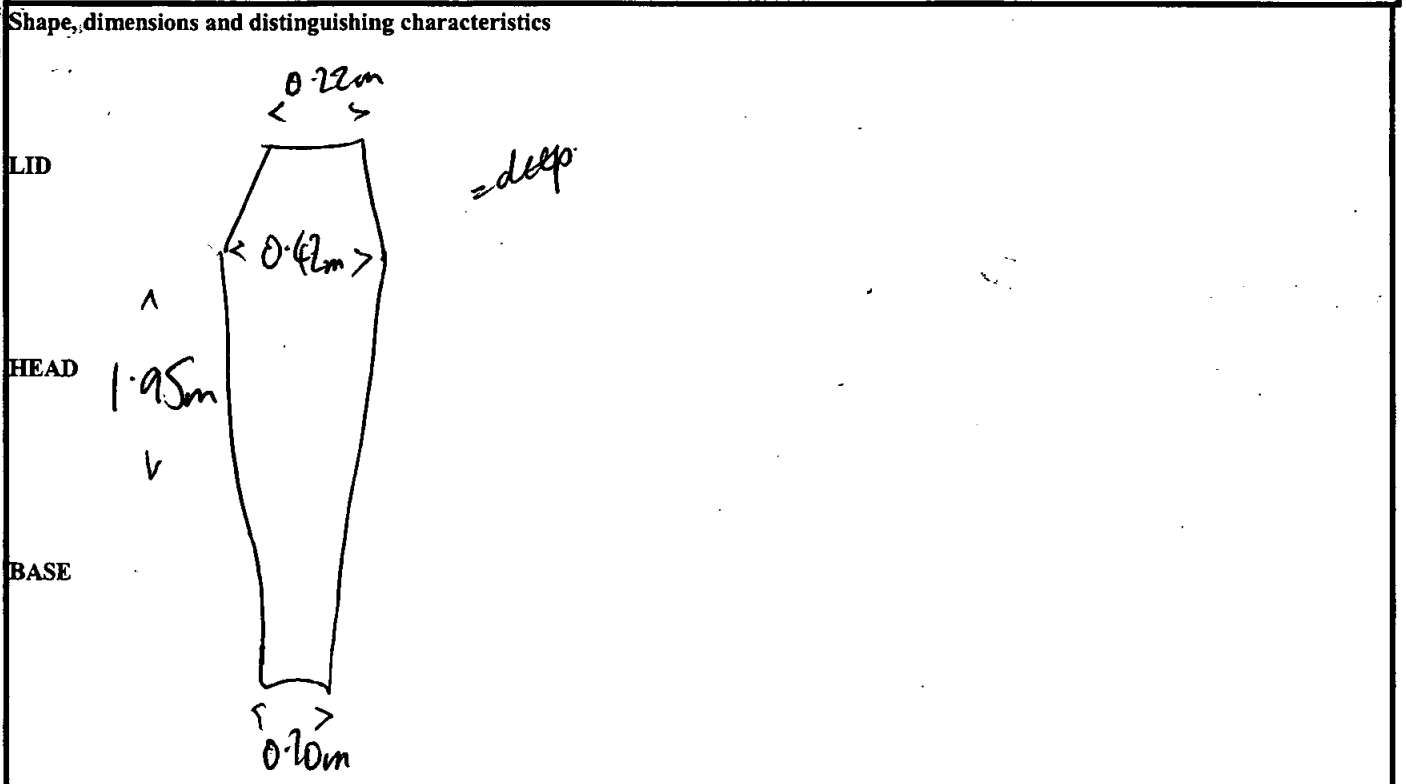

Recorder: <i>Tm</i>	Date: 14.11.00	Initials:
---------------------	----------------	-----------

db.

SITE 02200	COFFIN RECORD SHEET	CONTEXT NO. 911961
Trench:	Additional sheets: YES x 1.	Treatment: <del>DRY</del> / BONES.
Site sub-div: CRUPT BAN3	Grave fills	
Plan no: 7	Grave cut:	Finds None <del>DRY</del>
Section no:	Skeleton:	Breastplate ✓ Grip
Co-ordinates:	Matrix location: u/k 919	Hinge Bracket
Levels	Preservation: GOOD.	Fixing nails Shroud pins
Slide No.	Neg No:	Fabric Other finds

**Description** Pb Coffin  
EAST-WEST ALIGNED: 1" wide woven webbing/knitted textile with knot in tact @ ankles - modesty binding round ankles?

**Discussion**

Shape, dimensions and distinguishing characteristics

INSCRIPTION ON COFFIN :-

LID  
Mr  
Edward Keat  
Died 27th March  
1839  
Aged 59 Years

HEAD

BASE

0.28m  
0.38m  
1.40m  
0.24m

NOTE: - 0.30 -

Recorder: <i>Th</i>	Date: 14.11.00	Initials:
---------------------	----------------	-----------

Site Code

Context

**Outer Coffin**

Sample Ret.

OKR00

961

Recording Date 17/11/00

Associated Numbers .....

Condition 3

Dep. Plate

Legible

Inscription Mk/Edward Keat/Died 27<sup>th</sup> Dec<sup>r</sup>/1839/Aged 59 Yrs

same as 776 w/ 534 outer border.

Fabric lead

ormolou

brass

tin plated pewter

gilt tin

iron

silvered tin

enamelled

other .....

Sample Ret.

black polished.

**Shape of dep. plate**

square

rectangle

shield

tapered

lozenge

cartouche

oval

other .....

**Upholstery**

colour .....

shoddy

velvet

other .....

Sample Ret.

**Construction**

butt joint

mitred

pitched

other .....

**Grip plate**

Fabric = ormolou

brass

tin plated pewter

gilt tin

iron

silvered tin

enamelled

other .....

Sample Ret.

**Grip**

Fabric = ormolou

brass

iron

Sample Ret.

**Design**

swag of rose

horseshoe

cherub's head

plain

other .....

**Grip bolts**

**Corner bolts**

Type = gilt brass

brass

iron

other ..... Sample Ret.

**Lid motifs**

other ..... Sample Ret.

**Escutcheons**

other ..... Sample Ret.

**Upholstery nails**

brass

gilt brass

silvered brass

iron

enamelled

other ..... Sample Ret.

**Fixings**

panel nails

screws

hinges

lace

Sample Ret.

**Timber type** .....

Sample Ret.

**Interpretation / Comments**

.....  
 .....

db.

SITE 02R00	COFFIN RECORD SHEET	CONTEXT NO. <del>961</del> 962
Trench:	Additional sheets: YES x 1	Treatment: INTACT → NEETOP.
Site sub-div: LMP SAN3	Grave fills	
Plan no: 7.	Grave cut:	Finds None <del>WAAA</del>
Section no:	Skeleton:	Breastplate <input checked="" type="checkbox"/> Grip
Co-ordinates:	Matrix location: U/L 920 / 848	Hinge Bracket
Levels	Preservation: GOOD.	Fixing nails Shroud pins
Slide No.	Neg No:	Fabric Other finds

Description: ADULT PB COFFIN  
EAST-WEST BURIAL.

Discussion:

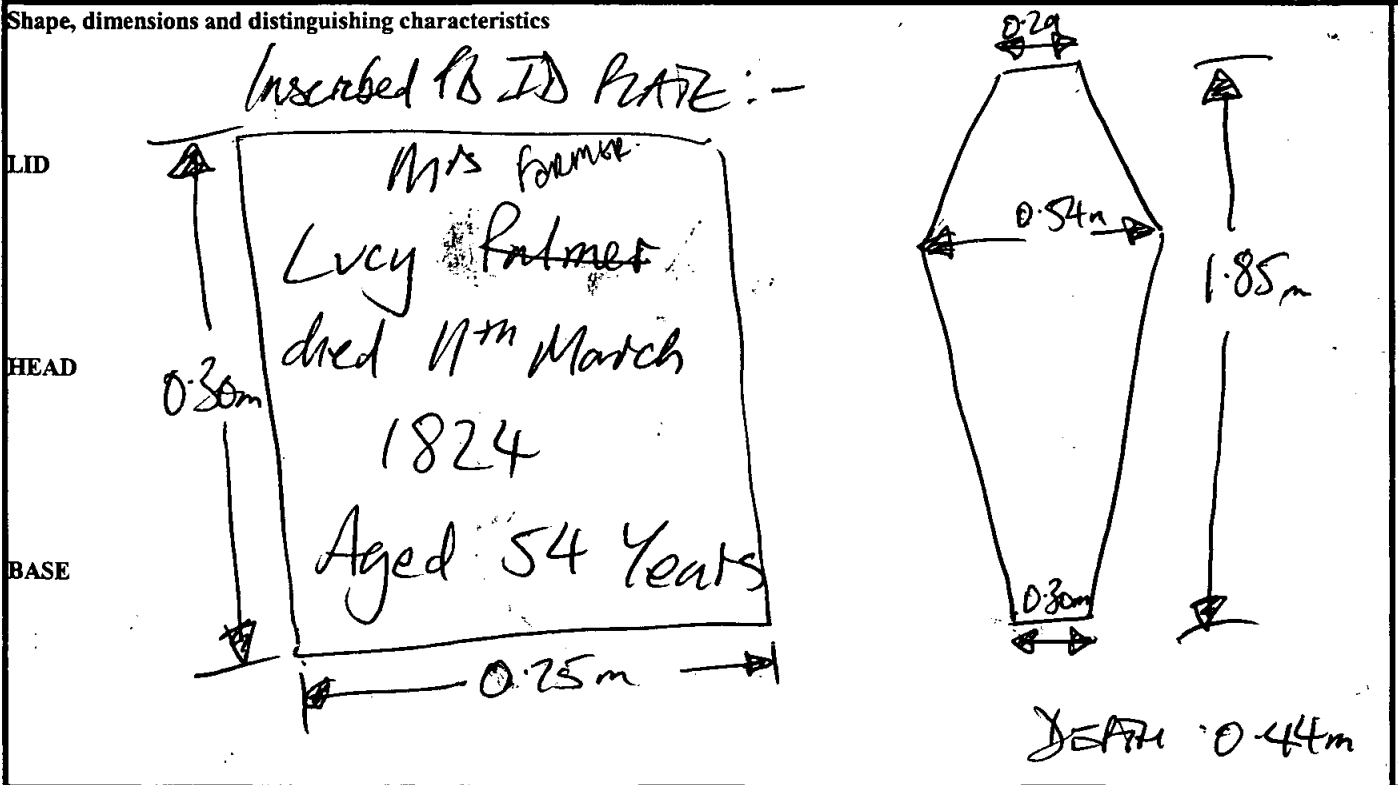

Recorder: M	Date: 14.11.00.	Initials:
-------------	-----------------	-----------

# Coffin Recording Sheet

Site Code

Context

## Outer Coffin

Sample Ret.

OLR00

962

Recording Date ..... 17/11/00 .....

Associated Numbers .....

Condition ..... 2 .....

Dep. Plate

Legible

Inscription "Mrs/harry Farmer / Died 11<sup>th</sup> March / 1824 / Aged 54 Years"  
362

some of ~~the~~ ~~material~~ ~~is~~ ~~now~~ ~~missing~~

Fabric lead  ormolou  brass  tin plated pewter  gilt tin   
iron  silvered tin  enamelled  other ..... Sample Ret.

black polished.

### Shape of dep. plate

square  rectangle  shield  tapered  lozenge   
cartouche  oval  other .....

### Upholstery

colour ..... shoddy  velvet  other ..... Sample Ret.

### Construction

butt joint  mitred  pitched  other .....

### Grip plate

Fabric = ormolou  brass  tin plated pewter  gilt tin   
 iron  silvered tin  enamelled  other ..... Sample Ret.

### Grip

Fabric = ormolou  brass  iron  Sample Ret.

### Design

swag of rose  horseshoe  cherub's head  plain

other .....

### Grip bolts

Corner bolts  Type = gilt brass  brass  iron

other ..... Sample Ret.

### Lid motifs

other ..... Sample Ret.

### Escutcheons

other ..... Sample Ret.

### Upholstery nails

brass  gilt brass  silvered brass  iron  enamelled

other ..... Sample Ret.

### Fixings

panel nails  screws  hinges  lace  Sample Ret.

### Timber type

Sample Ret.

### Interpretation / Comments

.....  
.....

db.

SITE 02100	COFFIN RECORD SHEET	CONTEXT NO. <del>963</del> 963.
Trench:	Additional sheets:	Treatment: → NEROP.
Site sub-div: CUMET BAN 3	Grave fills:	Finds None
Plan no: 7.	Grave cut:	
Section no:	Skeleton:	Breastplate Grip ✓ x 2 SWAL (5) ROSES
Co-ordinates:	Matrix location: (930)	Hinge
Levels:	Preservation: SQUASHED. SBI INTACT	Bracket
Slide No.	Neg No:	Fixing nails
		Shroud pins
		Fabric
		Other finds

Description: Ps ABOVE COFFIN WEST - EAST.

Discussion:

Shape, dimensions and distinguishing characteristics

INSCRIPTION: -

MRS JAY  
Frances Jay  
Died 8<sup>th</sup> Feb 9  
1844  
In her 54<sup>th</sup> yr

LID

HEAD

BASE

HEAD: - 0.24m

Recorder: M	Date: 12.11.00.	Initials:
-------------	-----------------	-----------



dk.

SITE OLR00.	COFFIN RECORD SHEET	CONTEXT NO. 964
Trench:	Additional sheets: YES x 1	Treatment: → NECROP.
Site sub-div: CRIP SAN3	Grave fills	
Plan no: 7	Grave cut:	Finds None
Section no:	Skeleton:	Breastplate ✓ Grip
Co-ordinates:	Matrix location: U/L 960.	Hinge Bracket
Levels	Preservation:	Fixing nails Shroud pins
Slide No.	Neg No:	Fabric Other finds

Description  
INFANT Pb COFFIN  
ORIENTED EAST-WEST.

Discussion

Shape, dimensions and distinguishing characteristics

LID

HEAD

BASE

INSCRIPTION: -  
MISS  
Mary Lumley  
died 2<sup>nd</sup> Jan  
1808  
Aged 18 Mon

DEPTH: - 0.26m

Recorder: M	Date: 14.11.00	Initials:
-------------	----------------	-----------

# Coffin Recording Sheet

Site Code

Context

ORL00

964

**Outer Coffin**

Sample Ret.

Recording Date ..... 15/11/.....

Associated Numbers .....

Condition .....

Dep. Plate

Legible

Inscription " Miss/Mary Lumley / Died 29<sup>th</sup> Jan<sup>y</sup> / 1808 / Aged 18 Mon

Fabric lead  ormolou  brass  tin plated pewter  iron  silvered tin  enamelled  other ..... Sample Ret.



**Shape of dep. plate**

square  rectangle  shield  tapered  lozenge   
 cartouche  oval  other .....

intents (61) w/ (31) border.

**Upholstery**

colour ..... shoddy  velvet  other ..... Sample Ret.

**Construction**

butt joint  mitred  pitched  other .....

**Grip plate**

Fabric = ormolou  brass  tin plated pewter  iron  silvered tin  enamelled  other ..... Sample Ret.

**Grip**

Fabric = ormolou  brass  iron  Sample Ret.

**Design**

swag of rose  horseshoe  cherub's head  plain

other .....

**Grip bolts**

Corner bolts  Type = gilt brass  brass  iron

other ..... Sample Ret.

**Lid motifs**

other .....

**Escutcheons**

other .....

**Upholstery nails**

brass  gilt brass  silvered brass  iron  enamelled

other ..... Sample Ret.

**Fixings**

panel nails  screws  hinges  lace  Sample Ret.

**Timber type** .....

Sample Ret.

**Interpretation / Comments**

.....  
 .....

do

SITE OL200		COFFIN RECORD SHEET	CONTEXT NO. 965
Trench:	Additional sheets:	Treatment: BODY HAS SKIN REMAINING → NECROP. NO DNA TAKEN	
Site sub-div: <b>CMH 843</b>	Grave fills:	Finds	
Plan no: <b>7.</b>	Grave cut:	None	
Section no:	Skeleton:	Breastplate ✓ Grip ✓ X1 - Spitalfields 4	
Co-ordinates:	Matrix location: <b>963</b> <b>965</b>	Hinge Bracket	
Levels:	Preservation: <b>poor - CORRODED / SPLIT SQUASHED.</b>	Fixing nails Shroud pins	
Slide No.:	Neg No.:	Fabric Other finds	

Description: **ADULT Pb coffin EAST WEST**      **BREASTPLATE (BRASS 20) WILLIAM GRAY MACKENZIE**

Discussion: **Esq<sup>re</sup> born ~~1805~~ 4th Dec 1805**

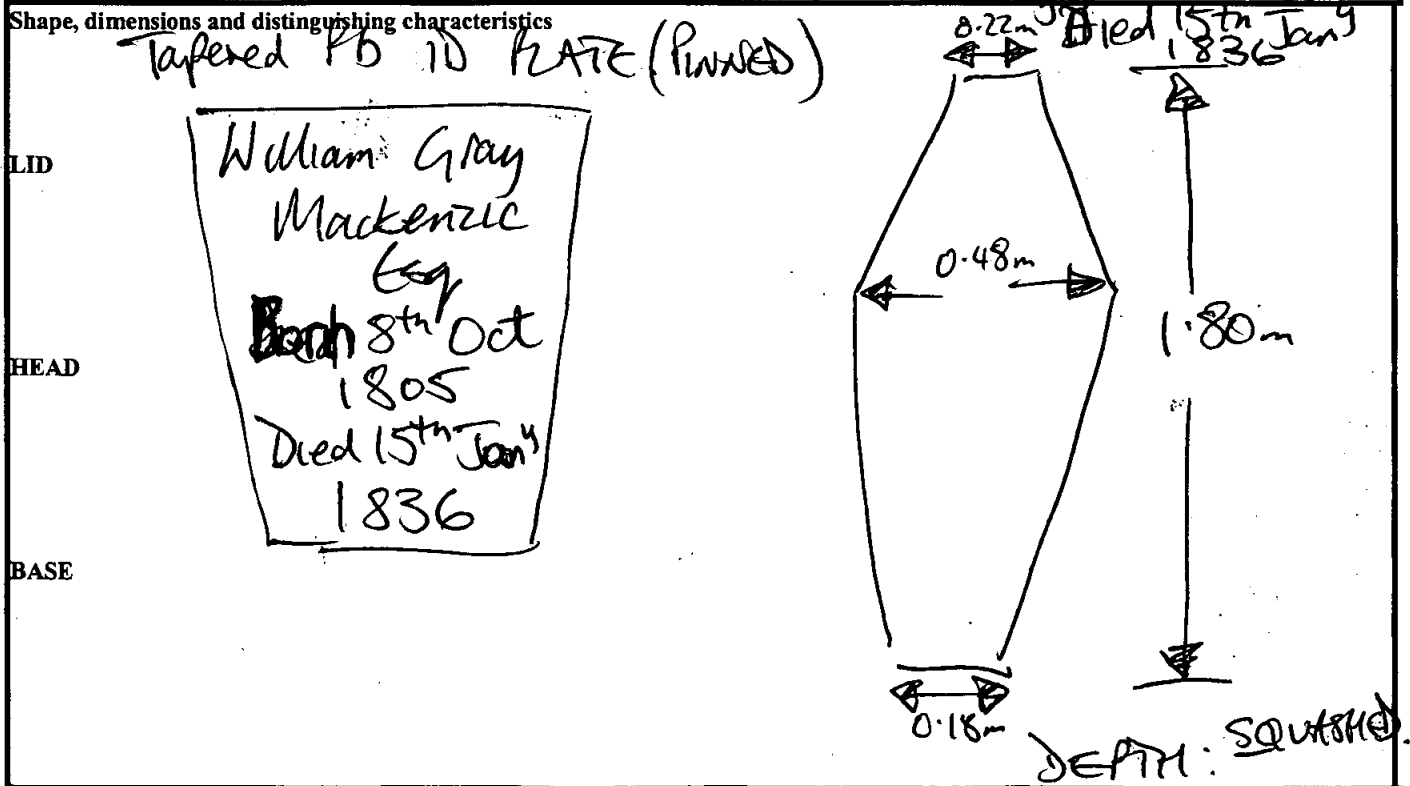

Recorder: **M**      Date: **14.11.00**      Initials:

db

SITE OLR00	COFFIN RECORD SHEET	CONTEXT NO. 966
Trench:	Additional sheets:	Treatment: BONES COLLECTED & DNA TAKEN.
Site sub-div: CAVITY BAY 3	Grave fills:	
Plan no: 7	Grave cut:	Finds None
Section no:	Skeleton:	Breastplate ✓ = ILLEGIBLE + inscription. Grip
Co-ordinates:	Matrix location: (922) (966)	Hinge Bracket
Levels:	Preservation: SQUARED / SHUT.	Fixing nails Shroud pins
Slide No.:	Neg No.:	Fabric Other finds

**Description** ADULT Pb COFFIN EAST-WEST p.b. lid has FE WIRE, SHEEP LEAD. SIDES DESTROYED. KNITTED WOOL SHROUD FRAGS.

**Discussion**

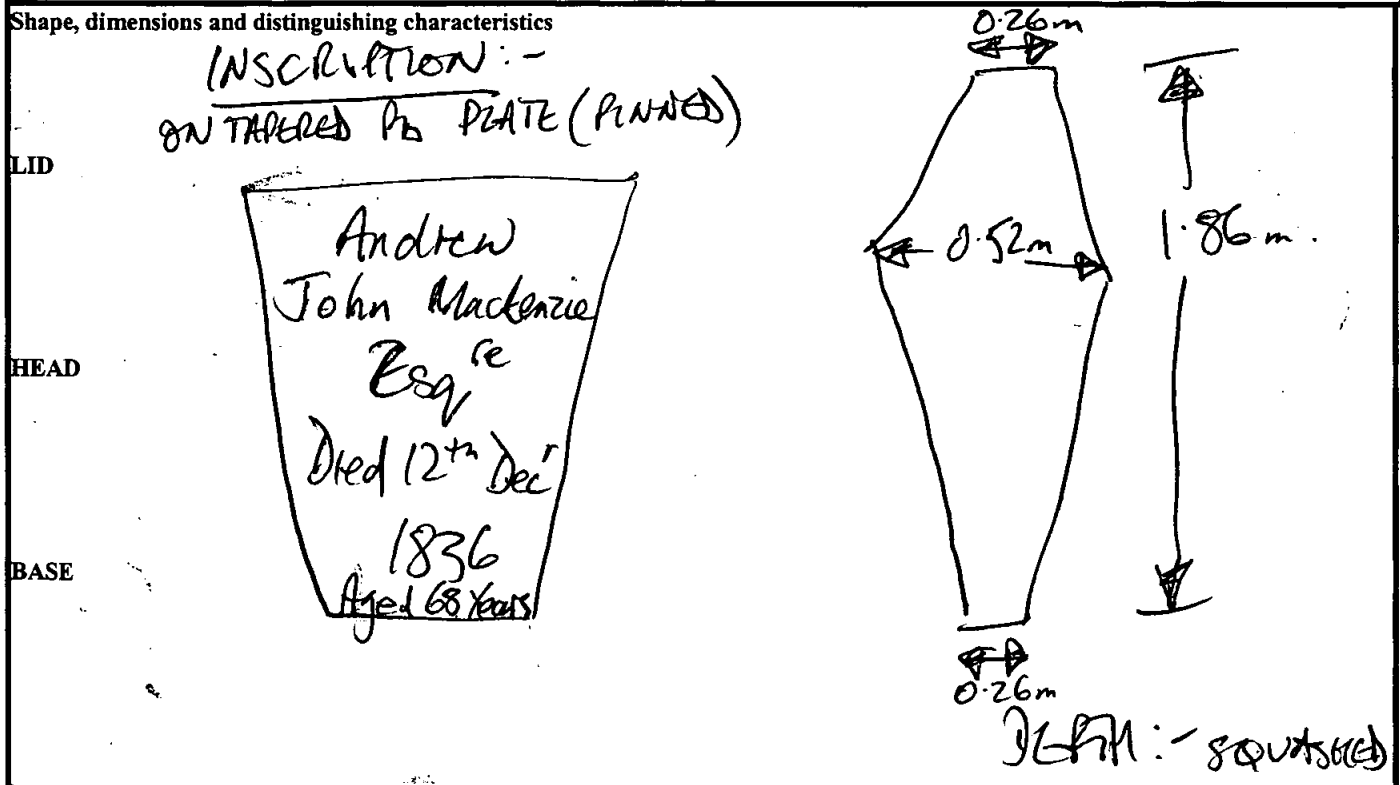

Recorder: B	Date: 14.11.00	Initials:
-------------	----------------	-----------

db.

SITE 22100	COFFIN RECORD SHEET	CONTEXT NO. 967
Trench:	Additional sheets:	Treatment: BONES LIFTED & DNA TAKEN.
Site sub-div: CANT B473	Grave fills:	Finds None
Plan no: 7	Grave cut:	
Section no:	Skeleton:	Breastplate ✓ + inscription. ⑤ Grip ✓ SWAG ROSES.
Co-ordinates:	Matrix location: ②① 967	Hinge
Levels:	Preservation: Poor - Corroded SQUASHER	Bracket
Slide No.:	Neg No:	Fixing nails
		Shroud pins
		Fabric
		Other finds

**Description** Adult Vb Coffin. Fe. ID PLATE ON COFFIN  
WEST-CAST - # SUFFERED -  
**Discussion** Fe. wire round inner edges of lid, cheap pb, traces of wood on outer.  
Mr John Farmer  
Died 18th Oct 1822  
Aged 54 years.

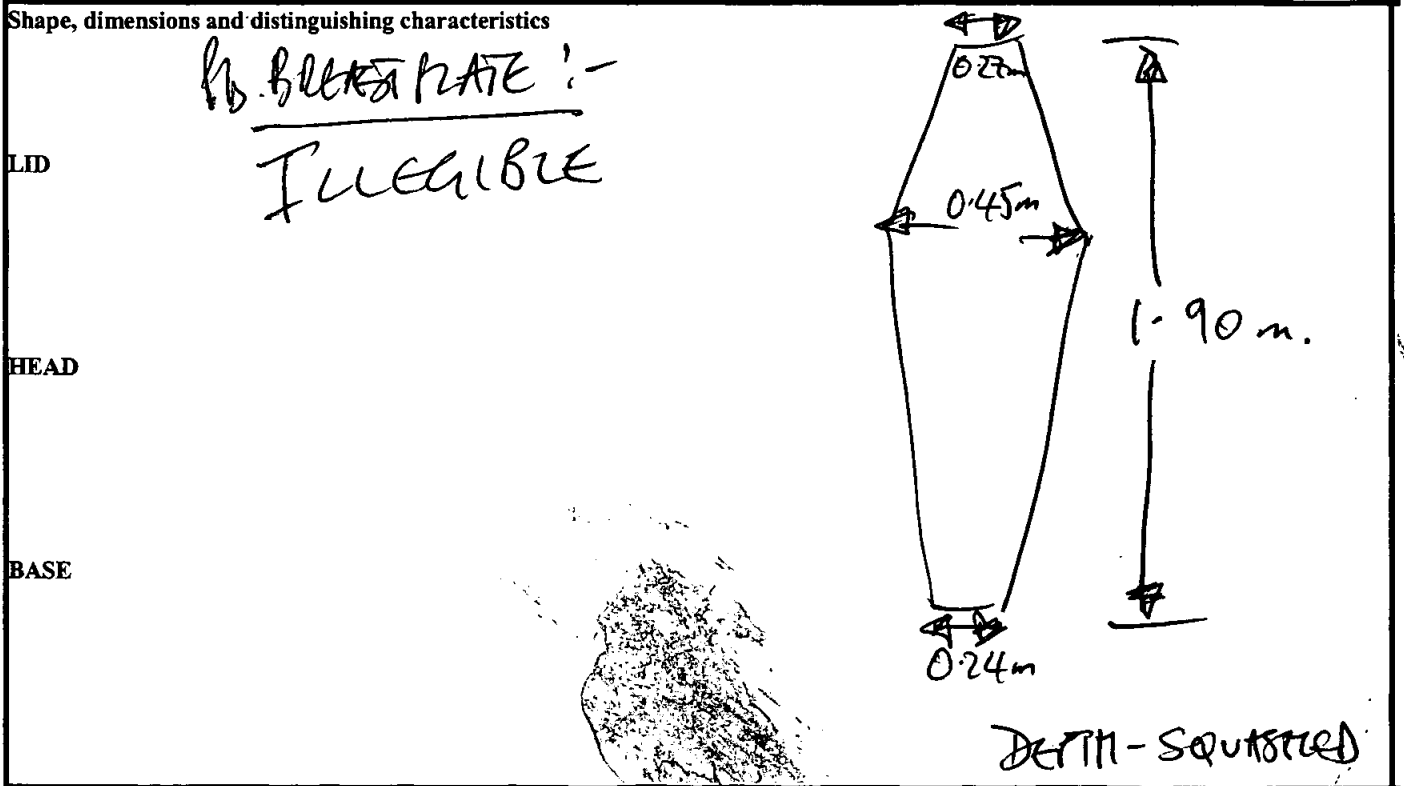

Recorder: M	Date: 14.11.00	Initials:
-------------	----------------	-----------

dlb

SITE OH200	COFFIN RECORD SHEET	CONTEXT NO. 968
Trench: CRYPT	Additional sheets: YES x1	Treatment: <del>CONTACTED</del> BONES LIFTED DNA TAKEN
Site sub-div: BAY 3	Grave fills	
Plan no: 7	Grave cut:	Finds None inscrip @ top
Section no:	Skeleton:	Breastplate top @ top Grip
Co-ordinates:	Matrix location: u/l 960	Hinge Bracket
Levels	Preservation: poor / corroded sides BOTTOM	Fixing nails Shroud pins
Slide No.	Neg No:	Fabric Other finds

Description adult p.b. coffin. E → N

Discussion

Shape, dimensions and distinguishing characteristics

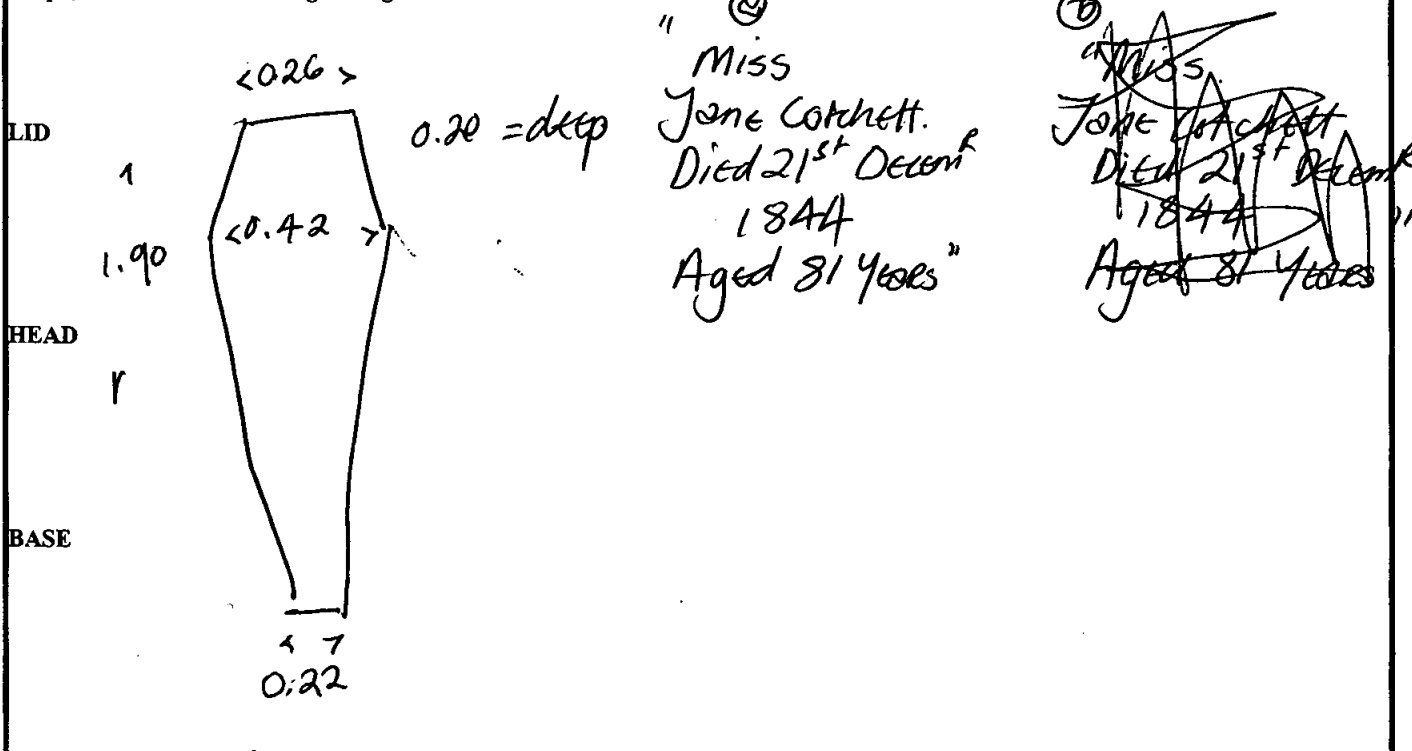

Recorder: MHL / Dem	Date: 15.11.00	Initials:
---------------------	----------------	-----------

Site Code

Context

**Outer Coffin**

Sample Ret.

ON100

968

Recording Date ..... 16/11/00 .....

Associated Numbers .....

Condition ..... 2 .....

Dep. Plate

Legible

Inscription 'Mae/ Jane Colchett/ Died 21 ~~Dec~~<sup>Decem</sup>/1844/ In her 81 Year'

Fabric lead  ormolou  brass  tin plated pewter  gilt tin   
 iron  silvered tin  *black polished* enamelled  other ..... Sample Ret.

**Shape of dep. plate**

square  rectangle  shield  tapered  lozenge   
 cartouche  oval  other ..... *some so 762 (w 618 inner border & 534 outer border)*

**Upholstery**

colour ..... shoddy  velvet  other ..... Sample Ret.

**Construction**

butt joint  mitred  pitched  other .....

**Grip plate**  Fabric = ormolou  brass  tin plated pewter  gilt tin   
 iron  silvered tin  enamelled  other ..... Sample Ret.

**Grip**  Fabric = ormolou  brass  iron  Sample Ret.

**Design** swag of rose  horseshoe  cherub's head  plain   
 other .....

**Grip bolts**  **Corner bolts**  Type = gilt brass  brass  iron   
 other ..... Sample Ret.

**Lid motifs**  other ..... Sample Ret.

**Escutcheons**  other ..... Sample Ret.

**Upholstery nails**  brass  gilt brass  silvered brass  iron  enamelled   
 other ..... Sample Ret.

**Fixings**  panel nails  screws  hinges  lace  Sample Ret.

**Timber type** ..... Sample Ret.

**Interpretation / Comments**

.....  
 .....

db.

SITE OLR00	COFFIN RECORD SHEET	CONTEXT NO. 969
Trench: CRYPT	Additional sheets:	Treatment: BONES LIFTED.
Site sub-div: BAY 3	Grave fills	DNA NOT POSSIBLE DUE TO POOR COND. OF BONES.
Plan no: 7	Grave cut:	Finds None Inscip (a)
Section no:	Skeleton:	Breastplate (b) poor cond pb Grip X 1 - conc. unid
Co-ordinates:	Matrix location: U11 926	Hinge Bracket
Levels	Preservation: poor/cond. + split	Fixing nails Shroud pins
Slide No.	Neg No:	Fabric Other finds

**Description** Adult p.b. coffin N→E body branned, poor cond.

**Discussion**

**Shape, dimensions and distinguishing characteristics**

(a) Rect. MR?  
WLm? Williamson  
Died 27th Feb  
1823  
Aged 75 YEARS

(b) illegible Rect.

Recorder: Mel/Dem Date: 18.11.00 Initials:



db.

SITE OLR00	COFFIN RECORD SHEET	CONTEXT NO. 970
Trench: CRYPT	Additional sheets: YES x2	Treatment: BONES LIFTED & DNA TAKEN.
Site sub-div: BAY 3	Grave fills	
Plan no: 7	Grave cut:	Finds None 1 x grip (a) shield 2 frags pb Breastplate (b) pb Grip (c) dir. Foot (d) pb.
Section no:	Skeleton:	
Co-ordinates:	Matrix location: u/l 925	Hinge Bracket
Levels	Preservation: DANARD 1	Fixing nails Shroud pins
Slide No.	Neg No:	Fabric Other finds

**Description**  
adult p.b. coffin. E → W, poor quality p.b. w/ few wires reinforcement round lid.

**Discussion**

**Shape, dimensions and distinguishing characteristics**

LID  
HEAD  
BASE

①  
"Miss  
Metilde Gibson  
Died 17<sup>th</sup> Jan<sup>y</sup>  
1836  
Aged 24 Yrs"

②  
"Miss  
Metilde Gibson  
Died 17<sup>th</sup> Jan<sup>y</sup>  
1836  
Aged 24 Yrs"

③  
Miss  
Metilde Gibson  
1836

Recorder: MEZ/DAN G	Date: 15.11.00.	Initials:
------------------------	--------------------	-----------

**Outer Coffin**

Sample Ret.

Site Code

Context

OLR00

970

Recording Date ..... 16/11/00 .....

Associated Numbers .....

Condition ..... 1 .....

Dep. Plate

Legible

Inscription "Miss/Matilda Gibson/Died 17<sup>th</sup> Jan/1836/Aged 24 Yrs"

Fabric lead  ormolou  brass  tin plated pewter  gilt tin   
iron  silvered tin  enamelled  other ..... Sample Ret.

**Shape of dep. plate**

*new type. see sheet.*

square  rectangle  shield  tapered  lozenge   
cartouche  oval  other .....

**Upholstery**

colour ..... shoddy  velvet  other ..... Sample Ret.

**Construction**

butt joint  mitred  pitched  other .....

Grip plate  Fabric = ormolou  brass  tin plated pewter  gilt tin   
iron  silvered tin  enamelled  other ..... Sample Ret.

Grip  Fabric = ormolou  brass  iron  Sample Ret.

Design swag of rose  horseshoe  cherub's head  plain   
other .....

Grip bolts  Corner bolts  Type = gilt brass  brass  iron   
other ..... Sample Ret.

Lid motifs  other .....

Escutcheons  other .....

Upholstery nails  brass  gilt brass  silvered brass  iron  enamelled   
other ..... Sample Ret.

Fixings  panel nails  screws  hinges  lace  Sample Ret.

Timber type ..... Sample Ret.

**Interpretation / Comments**

.....  
.....

db.

SITE 01100	COFFIN RECORD SHEET	CONTEXT NO. 971
Trench:	Additional sheets:	Treatment: INTACT - NECROPOLIS
Site sub-div: CAVE 6413	Grave fills	
Plan no: 7.	Grave cut:	Finds None ✓
Section no:	Skeleton: /	Breastplate Grip
Co-ordinates:	Matrix location: (971)	Hinge Bracket
Levels	Preservation: GOOD.	Fixing nails Shroud pins
Slide No.	Neg No:	Fabric Other finds

Description Pb ANVIL COFFIN - SOLDERED  
WEST-EAST ORIENTATED.  
TRACES OF INTER WOOD.

Discussion

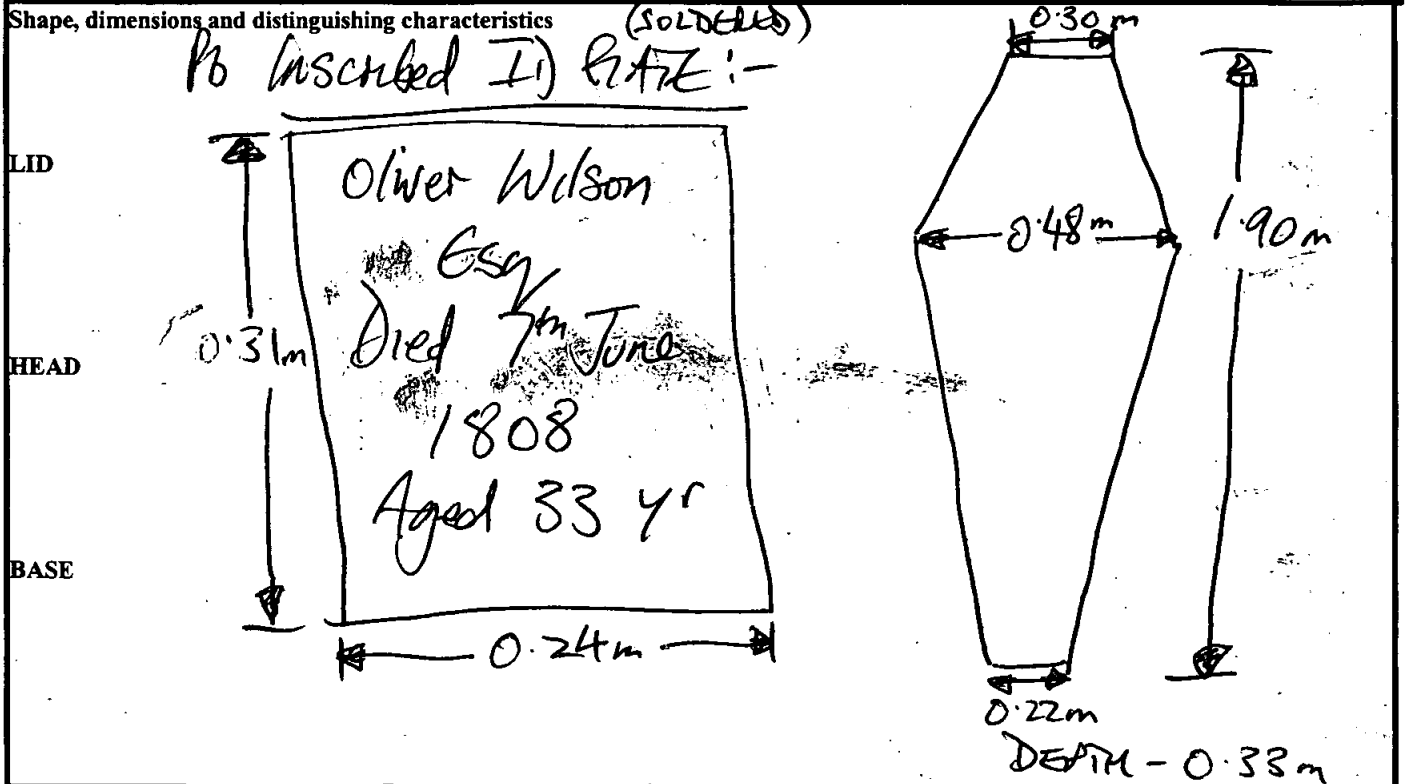



Recorder: Vn	Date: 15.11.00.	Initials:
-----------------	--------------------	-----------

db.

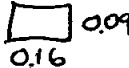
SITE	COFFIN RECORD SHEET	CONTEXT NO.
OL200		972
Trench: CRYPT	Additional sheets: YES x 2.	Treatment:
Site sub-div: Boy 3 (20)	Grave fills	<del>total</del> infant = totally decayed/NO BONE OR DNA pass
Plan no:	Grave cut:	Finds None head (C)
Section no:	Skeleton:	Breastplate x 2 - dep top (D) Grip & inscript (C)
Co-ordinates:	Matrix location: O/L.	Hinge Bracket
Levels	Preservation: <del>4</del> 3!	Fixing nails Shroud pins
Slide No.	Neg No:	Fabric Other finds

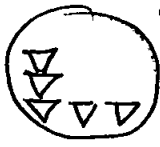
**Description**  
 (C) Miss Ellen Mumm Robinson / Died 6<sup>th</sup> May 1851 / Aged 1 year & 3 Mon. "  0.09  
 0.16

**Discussion**  
 (C) top = bordered  
 Miss Ellen Mumm Robinson / Died 6<sup>th</sup> May 1851 / Aged 1 Year & 3 Months. "  0.12  
 0.19

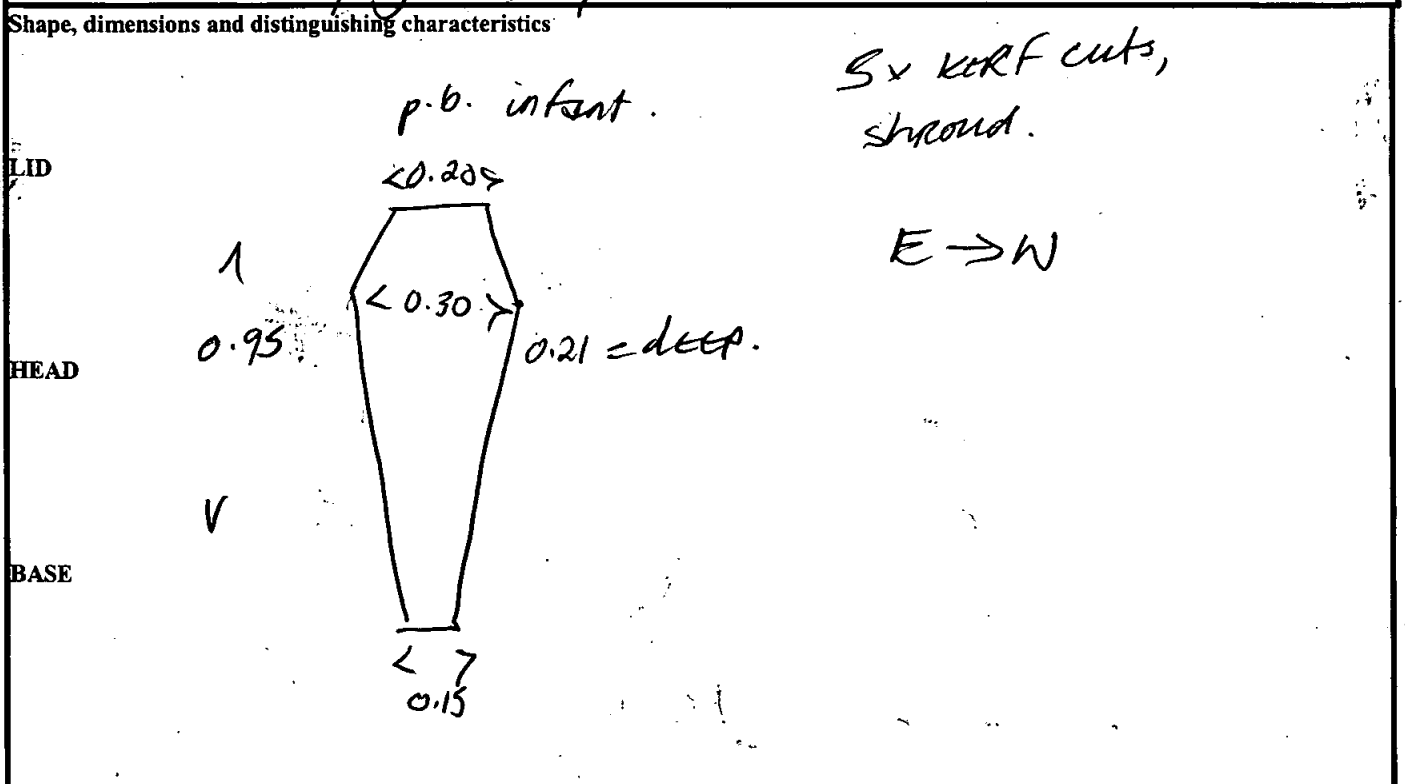

Recorder: \_\_\_\_\_ Date: \_\_\_\_\_ Initials: \_\_\_\_\_

# Coffin Recording Sheet

Site Code

Context

**Outer Coffin**

Sample Ret.

02200

972

Recording Date ..... 24/11/.....

Associated Numbers .....

Condition ..... 3 .....

Dep. Plate

Legible  INFANT

Inscription "Miss Ellen/Munn Robinson/Died 6<sup>th</sup> May/1851/Aged 1 Year/8.3 Mon<sup>s</sup>"  
new type - see sheet.

Fabric lead  ormolou  brass  tin plated pewter  gilt tin   
iron  silvered tin  enamelled  other ..... Sample Ret.

**Shape of dep. plate**

square  rectangle  shield  tapered  lozenge   
cartouche  oval  other .....

**Upholstery**

colour ..... shoddy  velvet  other ..... Sample Ret.

**Construction**

butt joint  mitred  pitched  other .....

**Grip plate**  Fabric = ormolou  brass  tin plated pewter  gilt tin   
iron  silvered tin  enamelled  other ..... Sample Ret.

**Grip**  Fabric = ormolou  brass  iron  Sample Ret.

**Design** swag of rose  horseshoe  cherub's head  plain   
other .....

**Grip bolts**  **Corner bolts**  **Type =** gilt brass  brass  iron   
other ..... Sample Ret.

**Lid motifs**  other ..... Sample Ret.

**Escutcheons**  other ..... Sample Ret.

**Upholstery nails**  brass  gilt brass  silvered brass  iron  enamelled   
other ..... Sample Ret.

**Fixings**  panel nails  screws  hinges  lace  Sample Ret.

**Timber type** ..... Sample Ret.

**Interpretation / Comments**

.....  
.....

db.

SITE OLR60	COFFIN RECORD SHEET	CONTEXT NO. 973
Trench: CRYPT	Additional sheets: YES x 2	Treatment: BODY LIFTED & DNA TAKEN.
Site sub-div: Box 3 [20]	Grave fills	
Plan no:	Grave cut:	Finds None
Section no: 7	Skeleton:	Breastplate - top. (A) inscript - plain ect (B) Grip x 1 (A)
Co-ordinates:	Matrix location: 4/L 972	Hinge plate frags etc.
Levels	Preservation: 2	Bracket Fixing nails Shroud pins
Slide No.	Neg No:	Fabric Other finds

Description  
woollen shroud in perfect condition (Lining type) bones in poor condition. adult p.b. coffin E → W.

Discussion

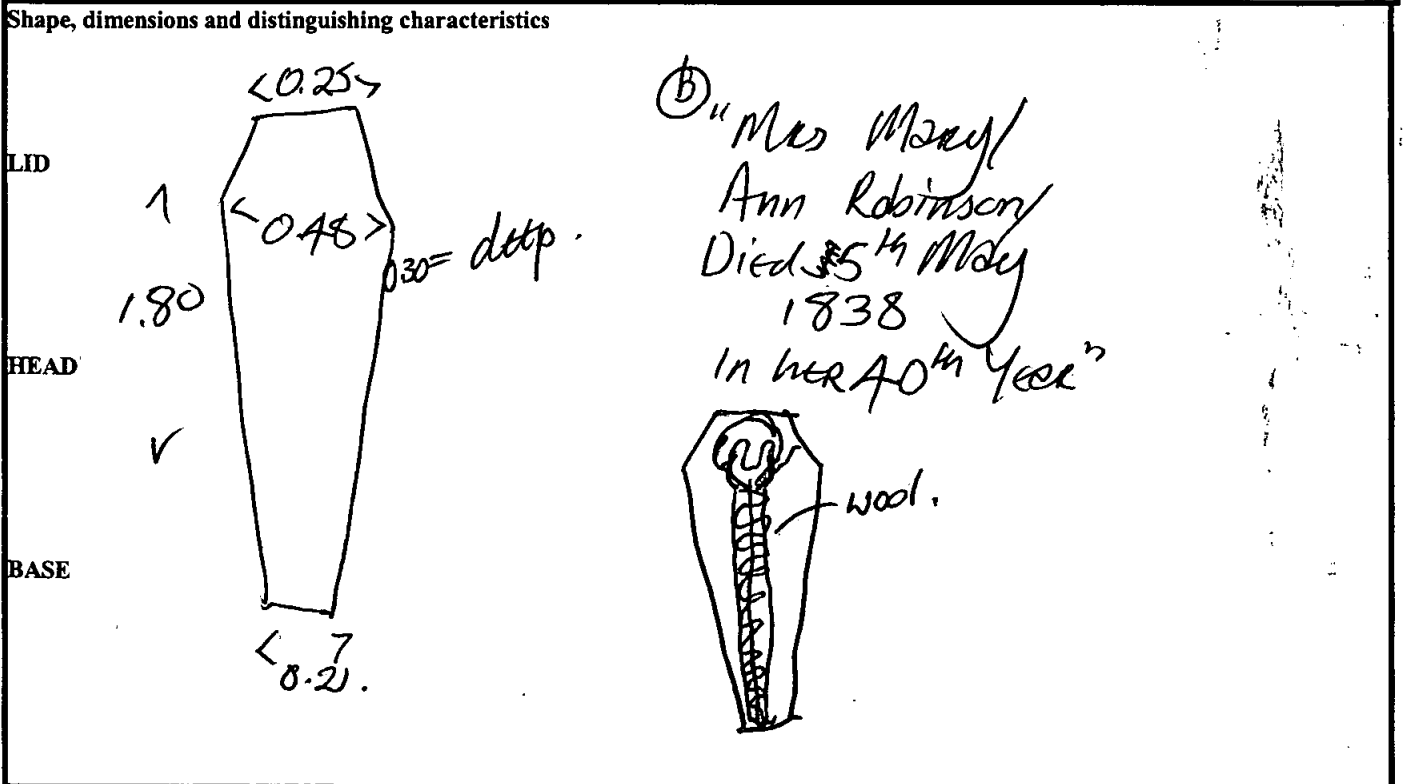

Recorder:	Date:	Initials:
-----------	-------	-----------

Site Code

Context

OR100

973

**Outer Coffin**

Sample Ret.

Recording Date ..... 17/11/00 .....

Associated Numbers .....

Condition ..... 2 .....

Dep. Plate

Legible

Inscription "Mrs Mary Ann Robinson / Died 5<sup>th</sup> May / 1838 / In her 40<sup>th</sup> Year"

Fabric lead  ormolou  brass  tin plated pewter  gilt tin   
iron  silvered tin  enamelled  other ..... Sample Ret.

*new type, sheet to follow.*

**Shape of dep. plate**

square  rectangle  shield  tapered  lozenge   
cartouche  oval  other .....

**Upholstery**

colour ..... shoddy  velvet  other ..... Sample Ret.

**Construction**

butt joint  mitred  pitched  other .....

Grip plate  Fabric = ormolou  brass  tin plated pewter  gilt tin   
iron  silvered tin  enamelled  other ..... Sample Ret.

Grip  Fabric = ormolou  brass  iron  Sample Ret.

Design swag of rose  horseshoe  cherub's head  plain   
other .....

Grip bolts  Corner bolts  Type = gilt brass  brass  iron   
other ..... Sample Ret.

Lid motifs  other ..... Sample Ret.

Escutcheons  other ..... Sample Ret.

Upholstery nails  brass  gilt brass  silvered brass  iron  enamelled   
other ..... Sample Ret.

Fixings  panel nails  screws  hinges  lace  Sample Ret.

Timber type ..... Sample Ret.

**Interpretation / Comments**

.....  
.....

db.

SITE 02200	COFFIN RECORD SHEET	CONTEXT NO. 97A
Trench: CAMPY	Additional sheets:	Treatment: BONES COLLECTED
Site sub-div: BAM	Grave fills:	
Plan no: 7	Grave cut:	Finds None
Section no:	Skeleton:	Breastplate ✓ bottom of PRICE - no name - top gone
Co-ordinates:	Matrix location: OLL 979 BAM 4	Hinge Bracket
Levels:	Preservation: 1 v. poor	Fixing nails Shroud pins
Slide No.:	Neg No.:	Fabric Other finds

Description adult p.b. E → W

Discussion

Shape, dimensions and distinguishing characteristics

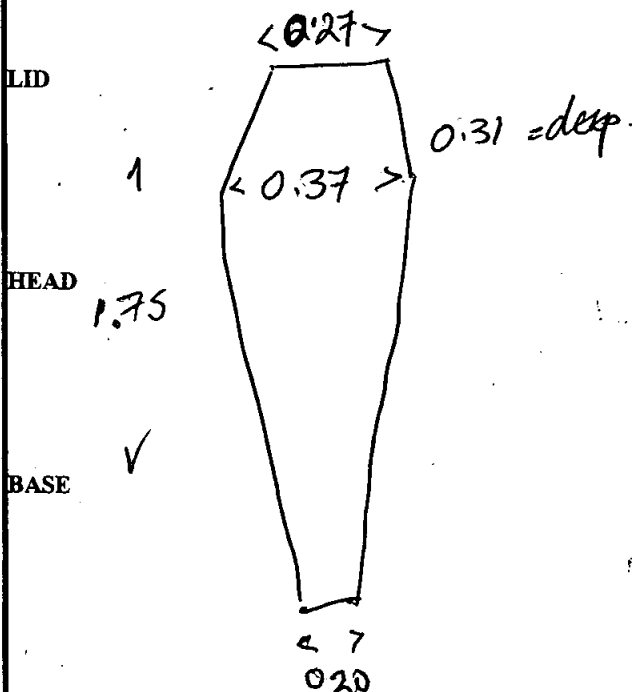

Recorder: ME	Date: 2/1/11	Initials:
--------------	--------------	-----------



db

SITE 02R00	COFFIN RECORD SHEET	CONTEXT NO. 975
Trench:	Additional sheets:	Treatment: BONES COLLECTED.
Site sub-div: CRYPT	Grave fills:	
Plan no: 7	Grave cut:	Finds None
Section no:	Skeleton:	Breastplate ✓ Illegible ish Grip
Co-ordinates:	Matrix location: <i>cell 975 BAY A</i>	Hinge Bracket
Levels:	Preservation: <i>1 v. poor</i>	Fixing nails Shroud pins
Slide No. Pathology Film 33	Neg No:	Fabric Other finds

Description *adult p.b. E → W* "Mr  
Chos  
Died  
1839

Discussion

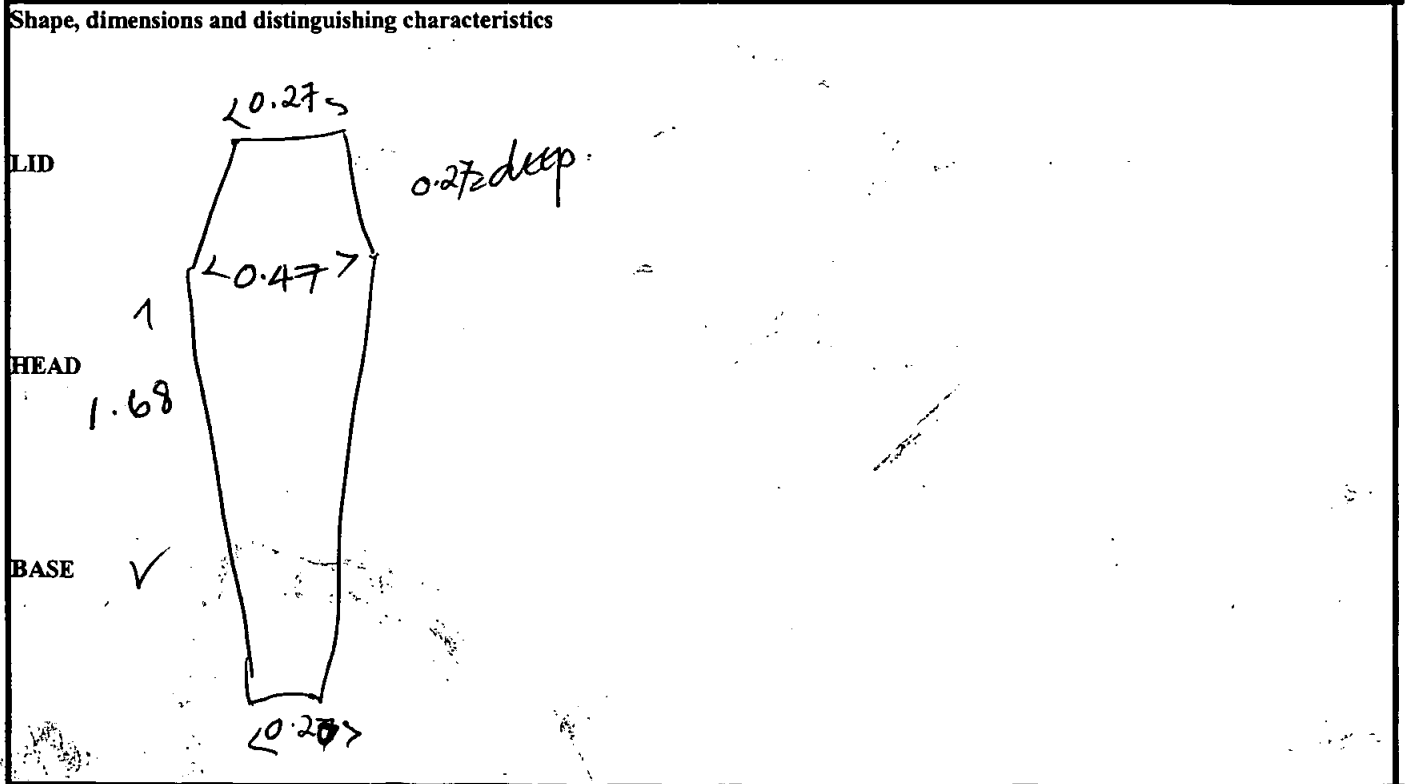

Recorder: <i>MEI</i>	Date: <i>21/11</i>	Initials:
----------------------	--------------------	-----------

db.

SITE ORROO	COFFIN RECORD SHEET	CONTEXT NO. 976
Trench:	Additional sheets: YES x 2	Treatment: BONES COLLECTED & DNA TAKEN
Site sub-div: CRYPT	Grave fills	
Plan no: 7	Grave cut:	Finds None
Section no:	Skeleton:	Breastplate ✓ top. pb. (b) manip (top) (a) Grip (sold)
Co-ordinates:	Matrix location: BAY A	Hinge
Levels	Preservation: 1. poor.	Bracket
Slide No.	Neg No:	Fixing nails
		Shroud pins
		Fabric
		Other finds

Description: adult p.b. W → ~~HE~~

Discussion:

Shape, dimensions and distinguishing characteristics

① "Mr Nightingale  
George ~~Nightingale~~  
Died 23<sup>rd</sup> Nov<sup>r</sup>  
1848  
Aged 67? Years"

② "Mr Nightingale  
George Nightingale  
Died 23<sup>rd</sup> Nov<sup>r</sup>  
1848  
Aged 61 Years"

Recorder: Mel Date: 21/11 Initials:

Site Code

Context

**Outer Coffin**

Sample Ret.

OR 200

97B

Recording Date ..... 27/11/00 .....

Associated Numbers .....

Condition ..... A .....

Dep. Plate

Legible

Inscription "Mr / George Nightingale / Died 23<sup>rd</sup> Nov<sup>r</sup> / 1848 / Aged 61 Years"

Fabric lead  ormolou  brass  tin plated pewter  gilt tin   
 iron  silvered tin  enamelled  other ..... Sample Ret.

**Shape of dep. plate**

J. PRICE & CO. SOME AS PER  
 NO 368 ~~OLD COFFIN~~  
 0.275  
 0.38  
 0.225

square  rectangle  shield  tapered  lozenge   
 cartouche  oval  other .....

**Upholstery**

colour ..... shoddy  velvet  other ..... Sample Ret.

**Construction**

butt joint  mitred  pitched  other .....

**Grip plate**

Fabric = ormolou  brass  tin plated pewter  gilt tin

iron  silvered tin  enamelled  other ..... Sample Ret.

**Grip**

Fabric = ormolou  brass  iron  Sample Ret.

**Design**

swag of rose  horseshoe  cherub's head  plain

other .....

**Grip bolts**

Corner bolts  Type = gilt brass  brass  iron

other ..... Sample Ret.

**Lid motifs**

other .....

Sample Ret.

**Escutcheons**

other .....

Sample Ret.

**Upholstery nails**

brass  gilt brass  silvered brass  iron  enamelled

other ..... Sample Ret.

**Fixings**

panel nails  screws  hinges  lace  Sample Ret.

**Timber type** .....

Sample Ret.

**Interpretation / Comments**

.....  
 .....

J. PRICE & CO, LONDON' now covers

1841-1848. 974 ~~is a smaller match~~

& 868 are smaller than 112, with 2 dec. borders & 'hallmark' in bottom RHS.

112 'hallmark' in bottom LHS. 1304: db border, raised hallmark bottom RHS w/ 'LONDON' & 'J. PRICE & CO' on bottom LHS.

so:

- lg size - 112 - 1 x border (inner) 1844, 'Mills', hallmark bottom LHS.
- sm size - 868 - 2 x borders, 1841, 'Aston', hallmark bottom RHS.
- sm size - 974 - " " 1848, 'Nightingale', " " "

868 & 905 & 1304 & 1169

112 'hallmark' is raised as opposed to ~~868~~ 974 which ~~is~~ is imprinted/indented, and a mirror image in terms of location on plate. ARE 112 & 868/974 - 1205 has no hallmark.

Closest Spitalfields match is (93) top.

- + sm size - ~~1205~~ 1205 - 1 x border (inner) 1848 'Woodin' - no hallmark visible (same size)
- + sm size - 1219 - 1 x border (inner) 1848 'Bucton' - hallmark bottom RHS.
- + lg size - 905 - 2 x borders 1848 'Gibson' - hallmark bottom RHS.
- + lg size - 1304 - 2 x borders / 1844 / 'Compton' - hallmark bottom RHS.
- + sm size - 1169 - 1 x border (inner) 1848 'Poctee' - hallmark bottom RHS.

db.

SITE OR100	COFFIN RECORD SHEET	CONTEXT NO. 977
Trench:	Additional sheets: YES x 2.	Treatment: BONES LIFTED & DNA TAKEN-
Site sub-div: CRYPT	Grave fills	
Plan no: 7	Grave cut:	Finds None Inscript. @ die & board. Breastplate ✓ top. ①
Section no:	Skeleton:	Grip
Co-ordinates:	Matrix location: BAM 4	Hinge
Levels	Preservation:	Bracket
Slide No.	Neg No:	Fixing nails Shroud pins
		Fabric Other finds

Description: adult p.b. E → W

Discussion:

Shape, dimensions and distinguishing characteristics

① "Mr George Nightingale  
Died 13<sup>th</sup> Oct  
1840  
Aged 23 Years"

② "Mr George Nightingale  
Died 13<sup>th</sup> Oct  
1841  
Aged 23 Years"

Recorder: MEI	Date: 2/11	Initials:
---------------	------------	-----------

Site Code

Context

**Outer Coffin**

Sample Ret.

CR200

977

Recording Date 24/11

Associated Numbers .....

Condition 2

Dep. Plate

Legible

Inscription "Mr George Nightingale / Died 13<sup>th</sup> October / 1840 / Aged 23 Years"

*new type - see sheet.*

Fabric lead  ormolou  brass  tin plated pewter  gilt tin   
 iron  silvered tin  enamelled  other ..... Sample Ret.

*black polished.*

**Shape of dep. plate**

square  rectangle  shield  tapered  lozenge   
 cartouche  oval  other .....

**Upholstery**

colour ..... shoddy  velvet  other ..... Sample Ret.

**Construction**

butt joint  mitred  pitched  other .....

**Grip plate**

Fabric = ormolou  brass  tin plated pewter  gilt tin

iron  silvered tin  enamelled  other ..... Sample Ret.

**Grip**

Fabric = ormolou  brass  iron  Sample Ret.

**Design**

swag of rose  horseshoe  cherub's head  plain

other .....

**Grip bolts**

Corner bolts  Type = gilt brass  brass  iron

other ..... Sample Ret.

**Lid motifs**

other .....

Sample Ret.

**Escutcheons**

other .....

Sample Ret.

**Upholstery nails**

brass  gilt brass  silvered brass  iron  enamelled

other ..... Sample Ret.

**Fixings**

panel nails  screws  hinges  lace  Sample Ret.

**Timber type** .....

Sample Ret.

**Interpretation / Comments**

.....  
 .....

db.

SITE <i>ORCOO</i>	COFFIN RECORD SHEET	CONTEXT NO. <i>978</i>
Trench: <i>CRYPT</i>	Additional sheets:	Treatment: <i>BONES COLLECTED.</i>
Site sub-div:	Grave fills	
Plan no:	Grave cut:	Finds None
Section no:	Skeleton:	Breastplate Grip
Co-ordinates:	Matrix location: <i>Box A</i>	Hinge Bracket
Levels	Preservation: <i>1 destroyed.</i>	Fixing nails Shroud pins
Slide No.	Neg No:	Fabric Other finds
Description: <i>adult truncated articulated legs in shreds of p.b. (E → W)</i>		
Discussion		
Shape, dimensions and distinguishing characteristics		
<p>LID</p> <p>HEAD</p>  <p>BASE</p>		
Recorder: <i>MEL</i>	Date: <i>2/11</i>	Initials:

Ho.

SITE 07H200	COFFIN RECORD SHEET	CONTEXT NO. 979
Trench:	Additional sheets:	Treatment: BONES COLLECTED
Site sub-div: CRYPT	Grave fills:	
Plan no: 7	Grave cut:	Finds: None
Section no:	Skeleton:	Breastplate: Grip
Co-ordinates:	Matrix location: u/l Bay 4 974.	Hinge: Bracket
Levels:	Preservation: 1	Fixing nails: Shroud pins
Slide No.:	Neg No.:	Fabric: Other finds up studs 5 00000 Fe.

Description: adult p.b. coffin E → W No name

Discussion:

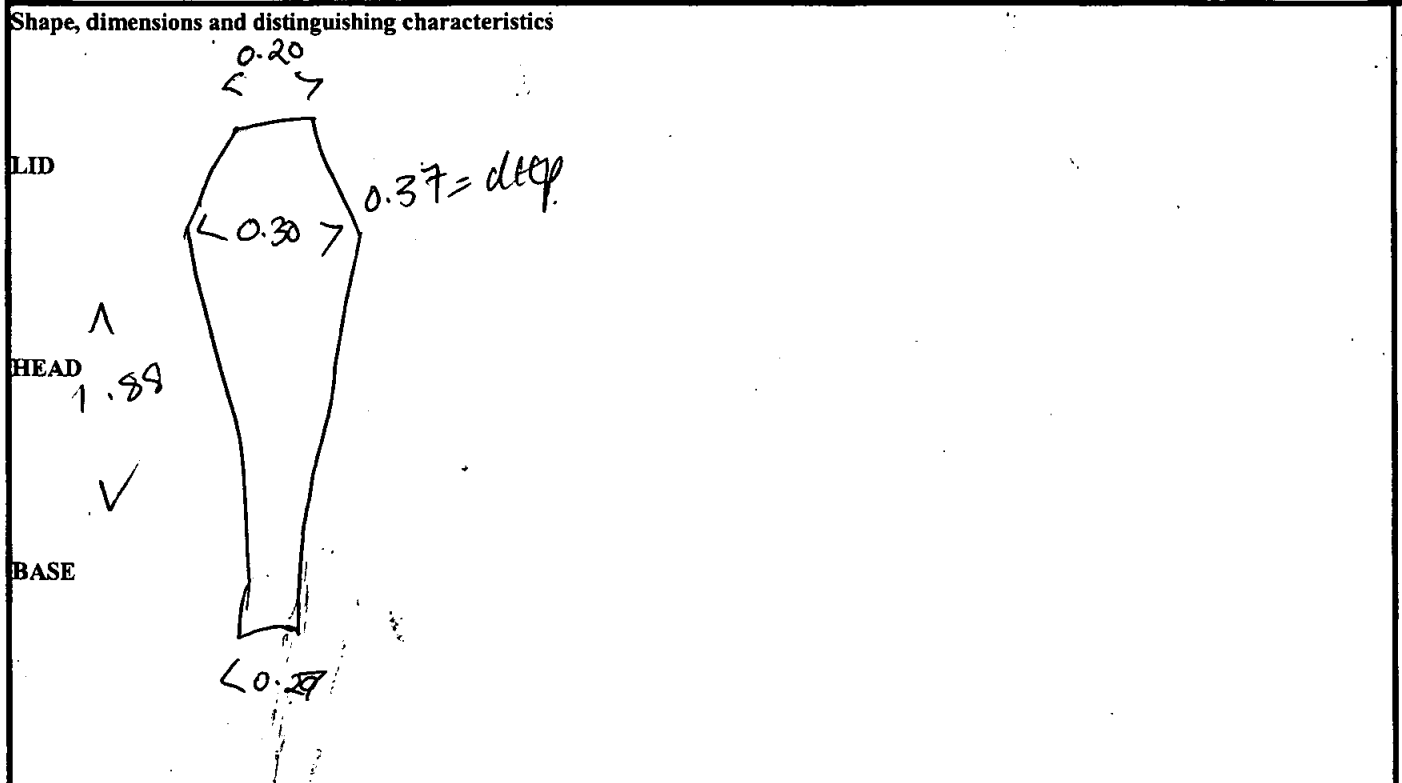

Recorder: ME	Date: 2/11	Initials:
--------------	------------	-----------



db.

SITE 01100	COFFIN RECORD SHEET	CONTEXT-NO. 980
Trench:	Additional sheets:	Treatment: BONES LIFTED, NOTEETH.DNA.
Site sub-div: CAMP 7	Grave fills	
Plan no: 7	Grave cut:	Finds None
Section no:	Skeleton:	Breastplate inscript. rect. ② Grip ✓ α 1 ①
Co-ordinates:	Matrix location: in [22] Bay 3. vault	Hinge Bracket
Levels	Preservation: 21	Fixing nails Shroud pins
Slide No.	Neg No:	Fabric Other finds

Description: adult p.b. coffin E → W, open ② Head/chest area, vandalised. Bron in coffin, bones largely decomposed etc.

Discussion

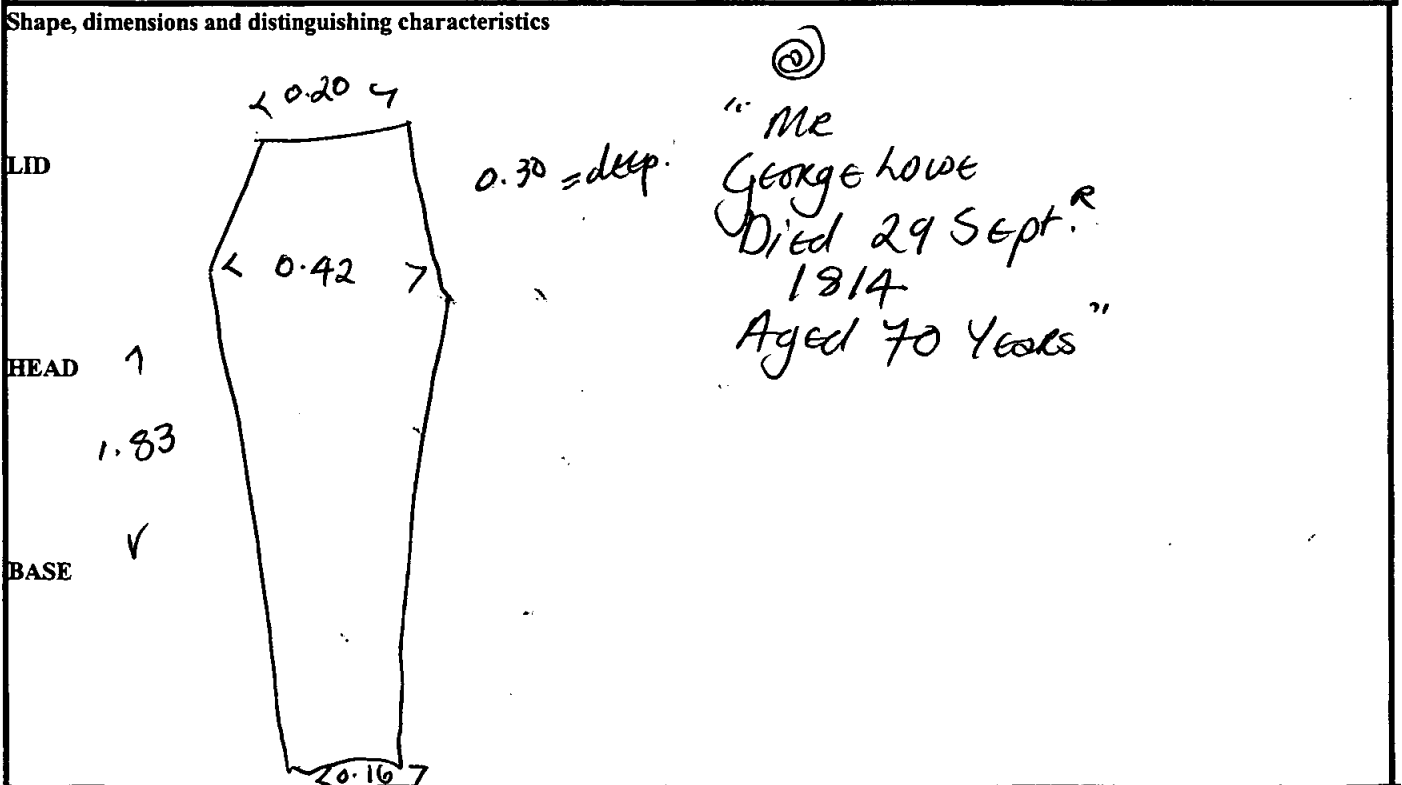

Recorder:	Date:	Initials:
-----------	-------	-----------

db.

SITE	COFFIN RECORD SHEET	CONTEXT NO.
OHROO		981
Trench:	Additional sheets: 465 x 2.	Treatment: BONES LIFTED.
Site sub-div: CRYPT	Grave fills	- NO DNA - NO TEETH
Plan no: 7	Grave cut:	Finds
Section no:	Skeleton:	None inscrip. rect (a) Breastplate ✓ rect (b)
Co-ordinates:	Matrix location: in 22 Bay 3 vault.	Hinge
Levels	Preservation: 1	Bracket
Slide No.	Neg No:	Fixing nails
		Shroud pins
		Fabric
		Other finds

**Description** adult p.b. coffin; coffin combic peiled lining. E → W. chest area opened - vented - no head. Bone inside coffin so bones pretty much decayed, only arms, lower legs, some vertebrae.

**Discussion**

**Shape, dimensions and distinguishing characteristics**

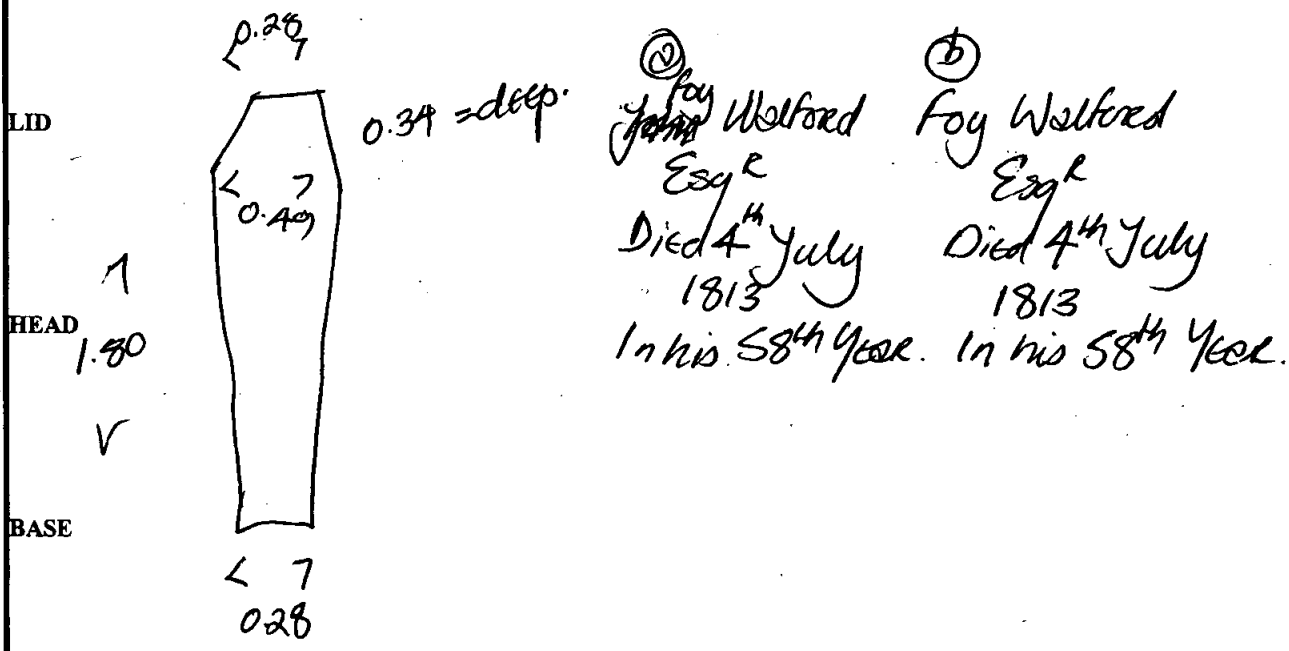

Recorder: Mel	Date: 21/11	Initials:
---------------	-------------	-----------

Site Code

Context

**Outer Coffin**

Sample Ret.

QR00

981

Recording Date ..... 24/11.

Associated Numbers .....

Condition ..... 3

Dep. Plate

Legible

Inscription "Foy Welford/ Esq & Died 4<sup>th</sup> July/ 1813/ In his 58<sup>th</sup> Year"  
no match - new type.

Fabric lead  ormolou  brass  tin plated pewter  gilt tin   
iron  silvered tin  enamelled  other ..... Sample Ret.

black polished.

**Shape of dep. plate**

square  rectangle  shield  tapered  lozenge   
cartouche  oval  other .....

**Upholstery**

colour ..... shoddy  velvet  other ..... Sample Ret.

**Construction**

butt joint  mitred  pitched  other .....

**Grip plate**  Fabric = ormolou  brass  tin plated pewter  gilt tin   
iron  silvered tin  enamelled  other ..... Sample Ret.

**Grip**  Fabric = ormolou  brass  iron  Sample Ret.

**Design** swag of rose  horseshoe  cherub's head  plain   
other .....

**Grip bolts**  **Corner bolts**  **Type =** gilt brass  brass  iron   
other ..... Sample Ret.

**Lid motifs**  other ..... Sample Ret.

**Escutcheons**  other ..... Sample Ret.

**Upholstery nails**  brass  gilt brass  silvered brass  iron  enamelled   
other ..... Sample Ret.

**Fixings**  panel nails  screws  hinges  lace  Sample Ret.

**Timber type** ..... Sample Ret.

**Interpretation / Comments**

.....  
.....

db.

SITE 02200	COFFIN RECORD SHEET	CONTEXT NO. 982
Trench:	Additional sheets:	Treatment (Remains bagged) NO BONES / NO DNA
Site sub-div: CAMPT	Grave fills:	
Plan no: 7	Grave cut:	Finds None Inscript. Lect. (2)
Section no:	Skeleton:	Breastplate Grip
Co-ordinates:	Matrix location: u/ 981 in vault 22, Bay 3.	Hinge Bracket
Levels:	Preservation: 3	Fixing nails Shroud pins
Slide No.:	Neg No.:	Fabric Other finds

Description  
p.b. adult. E → W, body banded, lining  
shroud pierced with combic, bone decomposed & unidentifiable  
- ost. analysis impossible.

Discussion

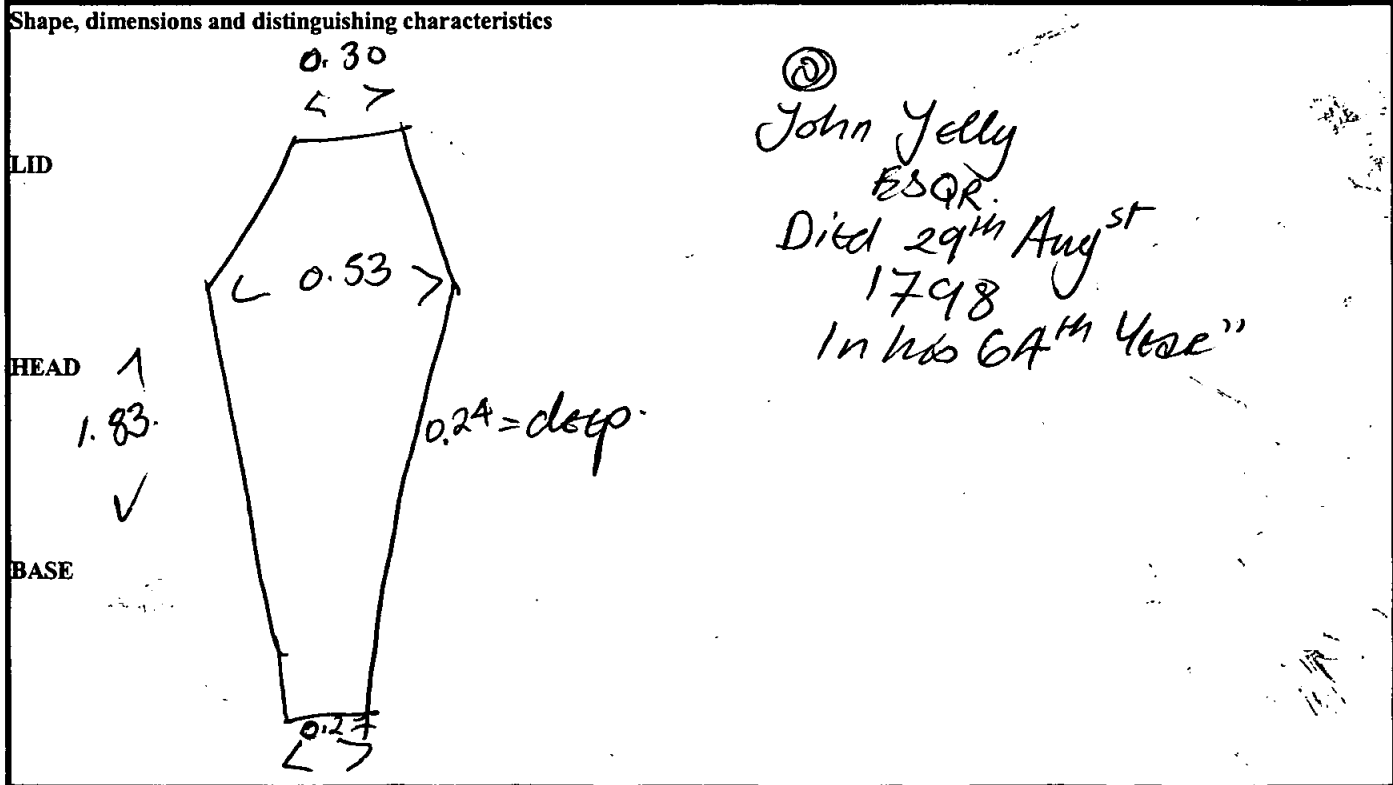

Recorder: Met	Date: 21/11	Initials:
---------------	-------------	-----------

db.

SITE 06100	COFFIN RECORD SHEET	CONTEXT NO. 983
Trench:	Additional sheets:	Treatment: BONES COLLECTED NO DNA, NO NAME.
Site sub-div: CRYPT	Grave fills:	
Plan no: 7	Grave cut:	Findings None ✓
Section no:	Skeleton:	Breastplate Grip
Co-ordinates:	Matrix location: W/L 980, Vault 22, Bay 3	Hinge Bracket
Levels:	Preservation: 2	Fixing nails Shroud pins
Slide No.:	Neg No.:	Fabric Other finds

Description: p.b. adult. E → W, unnamed, unscript.  
 Discussion: Removed before 980 placed on top - the 'ghost' was left by coffin exterior case from 980. Bones in poor cond; e.g. pelvis disintegrated; slightly not cataloged.

Shape, dimensions and distinguishing characteristics

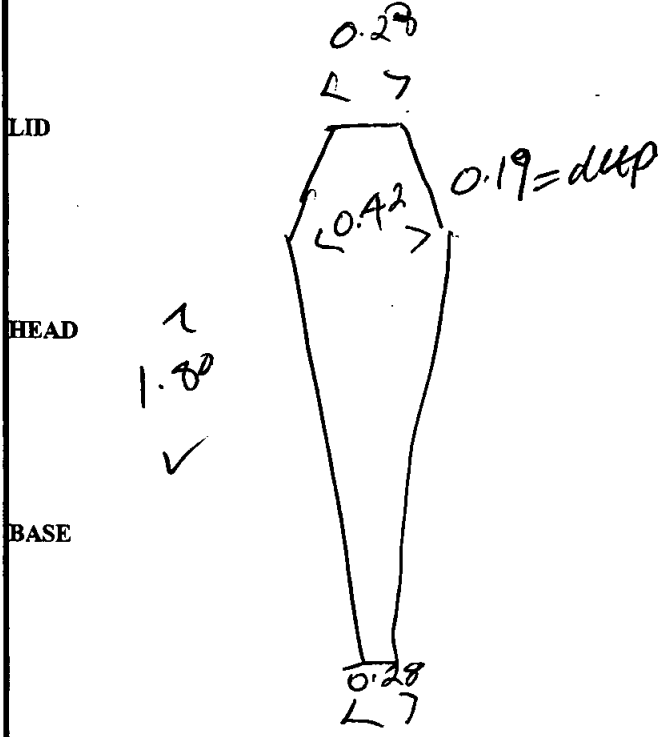

Recorder: MCL Date: 21/11 Initials:

db.

SITE 02100	COFFIN RECORD SHEET	CONTEXT NO. 984
Trench:	Additional sheets:	Treatment: NO NAME - NO DNA BONES LIFTED.
Site sub-div: CRYPT	Grave fills	
Plan no: 7	Grave cut:	Finds None
Section no:	Skeleton:	Breastplate Grip
Co-ordinates:	Matrix location: <del>VAN NORTON ROAD</del> , Box 3.	Hinge Bracket
Levels	Preservation: 2	Fixing nails Shroud pins
Slide No.	Neg No:	Fabric Other finds

Description: adult p.b. S → N, no name, v. wet, inner coffin well preserved.

Discussion:

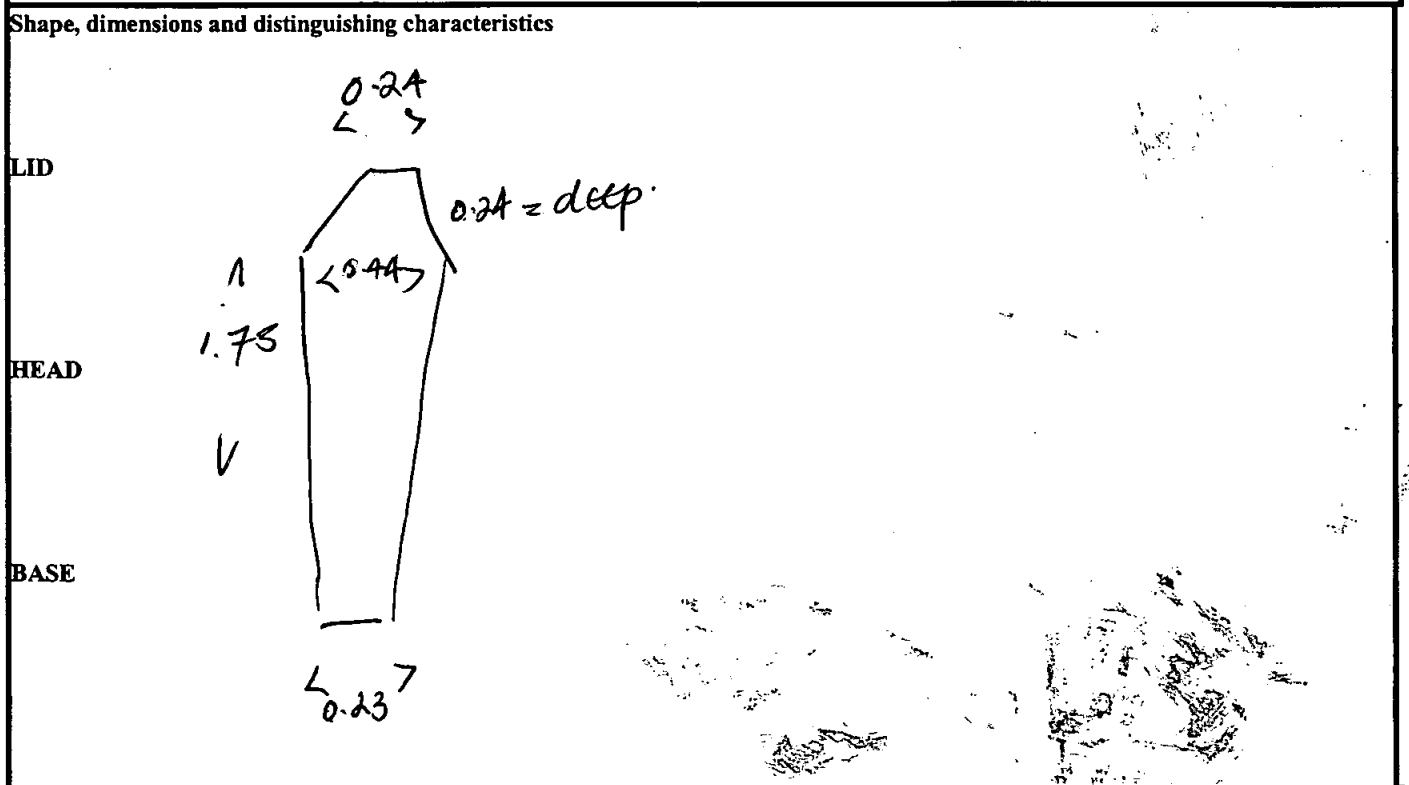

Recorder: Md	Date: 22/11	Initials:
--------------	-------------	-----------

db.

SITE OLX00	COFFIN RECORD SHEET	CONTEXT NO. 985
Trench:	Additional sheets:	Treatment: NO TEETH, DNA TAKEN, BODY LIFTED.
Site sub-div: CRYPT	Grave fills	
Plan no: 7	Grave cut:	Finds None
Section no:	Skeleton:	Breastplate inscript. <sup>(S)</sup> left. Grip
Co-ordinates:	Matrix location: Box 3 adj to 984	Hinge Bracket
Levels	Preservation: 2	Fixing nails Shroud pins
Slide No.	Neg No:	Fabric Other finds

Description  
adult p.b. S → N, lining shroud over body, a  
been in coffin, shroud pin sticking in top of head in shroud.  
Discussion  
Kapok-stuffed pillow of combic. Hession on exterior of unise  
Wooden coos.

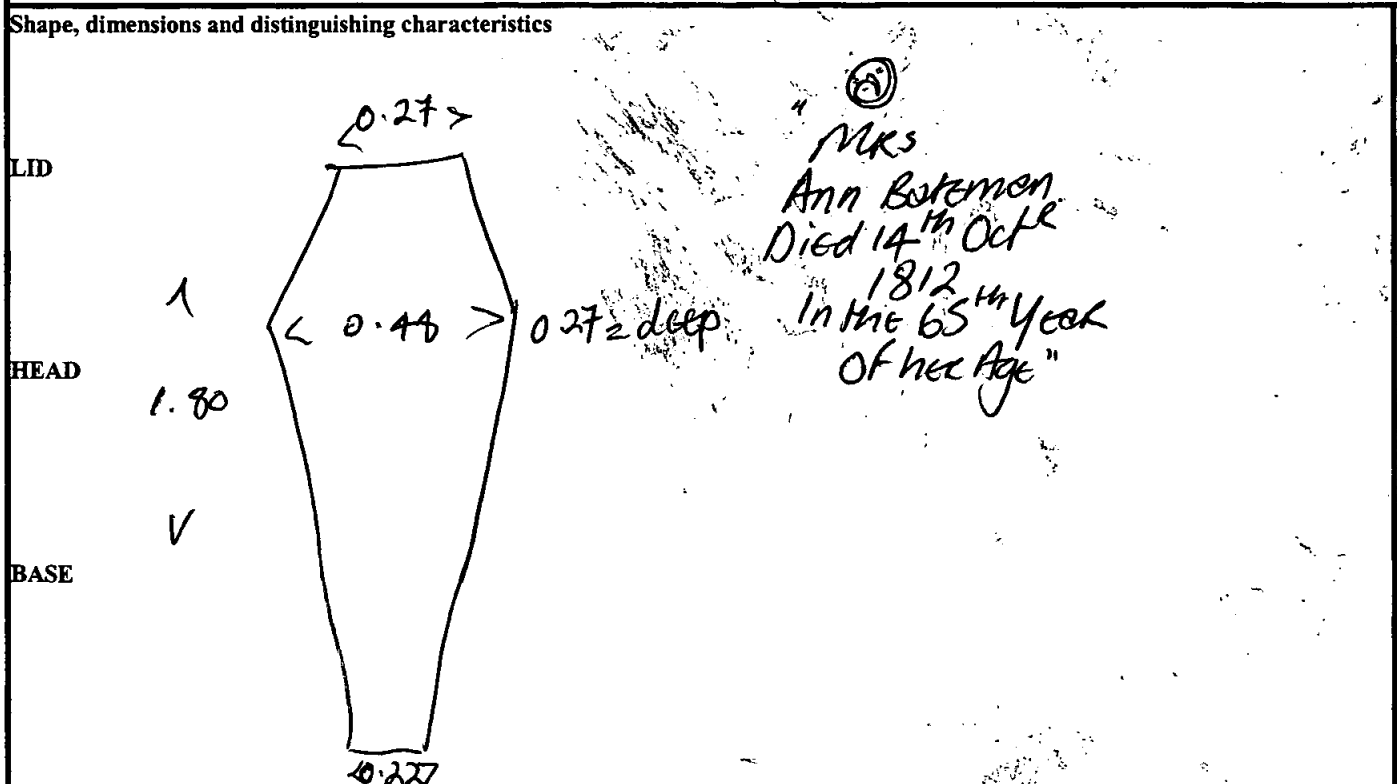

Recorder: Mel	Date: 22/11	Initials:
---------------	-------------	-----------

SITE	COFFIN RECORD SHEET	CONTEXT NO.
01200		986
Trench:	Additional sheets:	Treatment: DNA TAKEN (TEETH ONLY) BONES LIFTED.
Site sub-div: CRYPT	Grave fills:	
Plan no: 7	Grave cut:	Finds
		None
Section no:	Skeleton:	Breastplate ✓ alloy ① ② ③
		Grip ✓ ④ x plate Fe ③
Co-ordinates:	Matrix location: in Bay 3	Hinge
		Bracket
Levels	Preservation: 3	Fixing nails
		Shroud pins
Slide No.	Neg No:	Fabric
		Other finds

**Description**  
 adult p.b. coffin, N → S, iron (ish) Fe stud work, small studs close, db row, w/ large lid studs round edge.

**Discussion**  
 ③ "George Walford  
 Esq.  
 Died 15<sup>th</sup> MARCH  
 1850  
 In his 51<sup>st</sup> Year"  
 bones v. soft, been in coffin...



Recorder: Mel Date: 22/11 Initials:



SITE	COFFIN RECORD SHEET	CONTEXT NO.
02200		987
Trench:	Additional sheets:	Treatment: NO DNA, NO NAME BONES LIFTED.
Site sub-div: CRYPT	Grave fills	
Plan no: 7	Grave cut:	Finds None ✓
Section no:	Skeleton:	Breastplate Grip
Co-ordinates:	Matrix location: Bay 3, in vault 22.	Hinge Bracket
Levels	Preservation: 2	Fixing nails Shroud pins
Slide No.	Neg No:	Fabric Other finds

**Description** sub adult p.p., no name, W → E, (shroud lining type), + black cambric clothing, charcoal & wood shavings in base of coffin, body v. badly decomposed, bottom has adult remains

**Discussion** (lots of charcoal - cremation?) vertebrae etc. Coffin was not compromised @ foot area. sitting on brick floor of vault.

Shape, dimensions and distinguishing characteristics

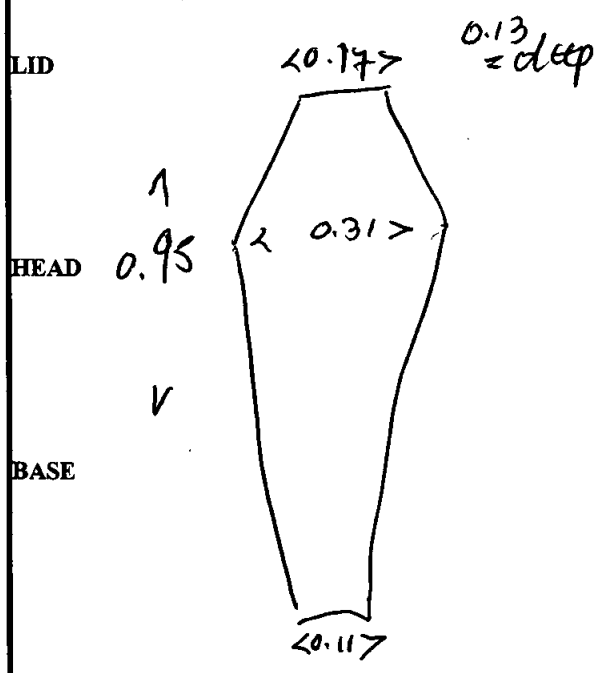

Recorder: Met	Date: 22/11	Initials:
---------------	-------------	-----------

SITE	COFFIN RECORD SHEET	CONTEXT NO.
0LR00		988
Trench: CRYPT	Additional sheets:	Treatment: BONES LIFTED, - NO DNA, NO NAME.
Site sub-div:	Grave fills	
Plan no:	Grave cut:	Finds None
Section no:	Skeleton:	Breastplate Grip
Co-ordinates:	Matrix location: in vault 22, Bay 3	Hinge Bracket
Levels	Preservation:	Fixing nails Shroud pins
Slide No.	Neg No:	Fabric Other finds studs Fe x 5

Description adult pb. adj to 987, W → E, shroud frags, bones in poor cond. sitting on brick floor of vault

Discussion

Shape, dimensions and distinguishing characteristics

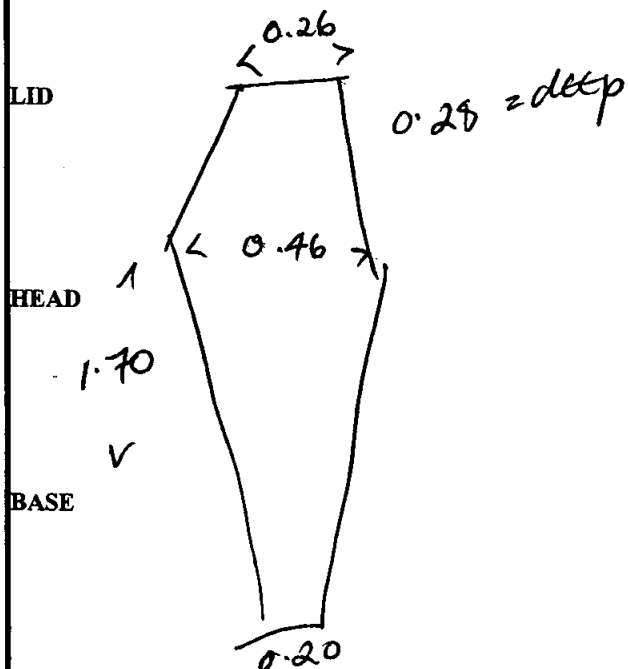

Recorder: MGL	Date: 22/11/	Initials:
---------------	--------------	-----------

SITE	COFFIN RECORD SHEET	CONTEXT NO.
62100		989
Trench:	Additional sheets: YES x1	Treatment: NO TEETH, DNA TAKEN, BONES COLLECTED
Site sub-div: CRYPT	Grave fills	
Plan no: 7	Grave cut:	Finds
		None
Section no:	Skeleton:	Breastplate <input checked="" type="checkbox"/> (B) In situ - Lect. (C) Grip
Co-ordinates:	Matrix location: in Bay 3, adj to 990,	Hinge
Levels	Preservation: 2	Bracket
Slide No.	Neg No:	Fixing nails
		Shroud pins
		Fabric
		Other finds

Description: adult p.b. W → E. , body not shrouded, but bones are in v. poor cond.

Discussion

Shape, dimensions and distinguishing characteristics

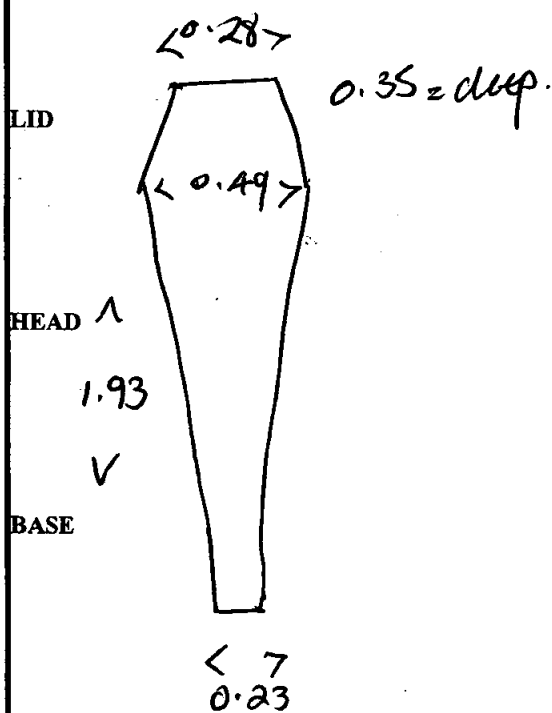

(C)  
"Matthew Hewlett  
Died 26<sup>th</sup> Nov<sup>r</sup>  
1808  
In his 75<sup>th</sup> Year"

Recorder: MEI	Date: 22/11	Initials:
---------------	-------------	-----------

**Outer Coffin**

Sample Ret:

Site Code

Context

Recording Date ..... 24/11 .....

02000

989

Associated Numbers .....

Condition ..... 2 .....

Dep. Plate

Legible

Inscription *a Mr / Matthew Hewlett / Died 20<sup>th</sup> Nov / 1803 / In his 56<sup>th</sup> Year*

Fabric lead  ormolou  brass  tin plated pewter  gilt tin   
 iron  silvered tin  enamelled  other ..... Sample Ret.

*Spltds (6) w/out outer border.*

**Shape of dep. plate**

square  rectangle  shield  tapered  lozenge   
 cartouche  oval  other .....

**Upholstery**

colour ..... shoddy  velvet  other ..... Sample Ret.

**Construction**

butt joint  mitred  pitched  other .....

**Grip plate**

Fabric = ormolou  brass  tin plated pewter  gilt tin   
 iron  silvered tin  enamelled  other ..... Sample Ret.

**Grip**

Fabric = ormolou  brass  iron  Sample Ret.

**Design**

swag of rose  horseshoe  cherub's head  plain   
 other .....

**Grip bolts**

Corner bolts  Type = gilt brass  brass  iron   
 other ..... Sample Ret.

**Lid motifs**

other ..... Sample Ret.

**Escutcheons**

other ..... Sample Ret.

**Upholstery nails**

brass  gilt brass  silvered brass  iron  enamelled   
 other ..... Sample Ret.

**Fixings**

panel nails  screws  hinges  lace  Sample Ret.

**Timber type** .....

Sample Ret.

**Interpretation / Comments**

.....  
 .....

SITE	COFFIN RECORD SHEET	CONTEXT NO.
02100		990
Trench:	Additional sheets: YES X1	Treatment: BONES LIFTED NO TEETH, DNA TAKEN
Site sub-div: CRYPT	Grave fills	
Plan no: 7	Grave cut:	Finds None
Section no:	Skeleton:	Breastplate ✓ Inscript @ rect Grip - 1 pc conc. unid pb g. plate db ch. w/ slt Hinge (31)
Co-ordinates:	Matrix location: Bay 3, <del>adj to 999</del> adj to 999	Bracket
Levels	Preservation: 2	Fixing nails Shroud pins
Slide No.	Neg No:	Fabric - belt on rev of g. plate Other finds

**Description** adult pb. W → E, full filled lining (punched lace combec) & lining shroud, bones v. soft, kapok-filled mattress. v pillow. v. long hair.

**Discussion**

**Shape, dimensions and distinguishing characteristics**

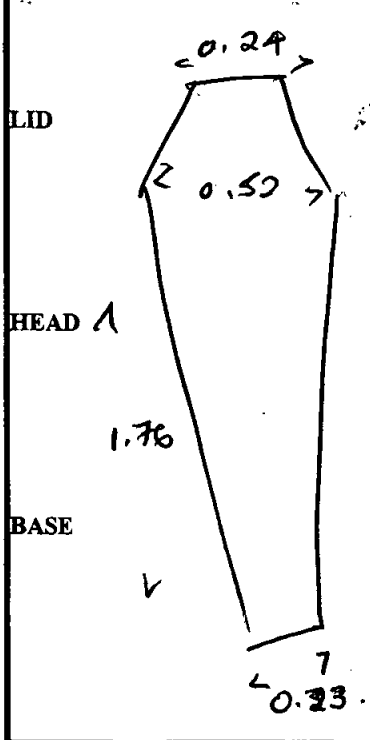

0.30 = deep.

② " MRS  
Eliz<sup>th</sup> Hewlett  
Died 28<sup>th</sup> Oct  
1810  
In her 80<sup>th</sup> Year

Recorder: MGI	Date: 22/11	Initials:
---------------	-------------	-----------

**Outer Coffin**

Sample Ret.

Site Code

Context

Recording Date ..... *24/11/00* .....

*OKR00*

*990*

Associated Numbers .....

Condition ..... *1* .....

Dep. Plate

Legible  *ISH*

Inscription *"Miss/Eliz<sup>m</sup> Hewlett/Died 28<sup>th</sup> Oct<sup>r</sup>/1810/In her 80<sup>th</sup> Year"  
spthds ⑧ w/ 621 outer border.*

Fabric lead  ormolou  brass  tin plated pewter  gilt tin   
iron  silvered tin  enamelled  other ..... Sample Ret.

**Shape of dep. plate**

square  rectangle  shield  tapered  lozenge   
cartouche  oval  other .....

**Upholstery**

colour ..... shoddy  velvet  other *beize on rev. of dep plate* ..... Sample Ret.

**Construction** butt joint  mitred  pitched  other .....

**Grip plate**  Fabric = ormolou  brass  tin plated pewter  gilt tin   
iron  silvered tin  enamelled  other ..... Sample Ret.

**Grip**  Fabric = ormolou  brass  iron  Sample Ret.

**Design** swag of rose  horseshoe  cherub's head  plain   
other .....

**Grip bolts**  **Corner bolts**  Type = gilt brass  brass  iron   
other ..... Sample Ret.

**Lid motifs**  other ..... Sample Ret.

**Escutcheons**  other ..... Sample Ret.

**Upholstery nails**  brass  gilt brass  silvered brass  iron  enamelled   
other ..... Sample Ret.

**Fixings**  panel nails  screws  hinges  lace  Sample Ret.

**Timber type** ..... Sample Ret.

**Interpretation / Comments**

.....  
.....

SITE	COFFIN RECORD SHEET	CONTEXT NO.
02R00		991
Trench:	Additional sheets:	Treatment: BONES LIFTED, NO DNA, TOO SOFT
Site sub-div: CRYPT	Grave fills:	
Plan no: 7	Grave cut:	Finds None
Section no:	Skeleton:	Breastplate inside rect (2)
Co-ordinates:	Matrix location: in Bay 3	Hinge Bracket
Levels:	Preservation: 1	Fixing nails Shroud pins
Slide No.:	Neg No.:	Fabric Other finds

Description: infant p.b coffin N→S

Discussion:

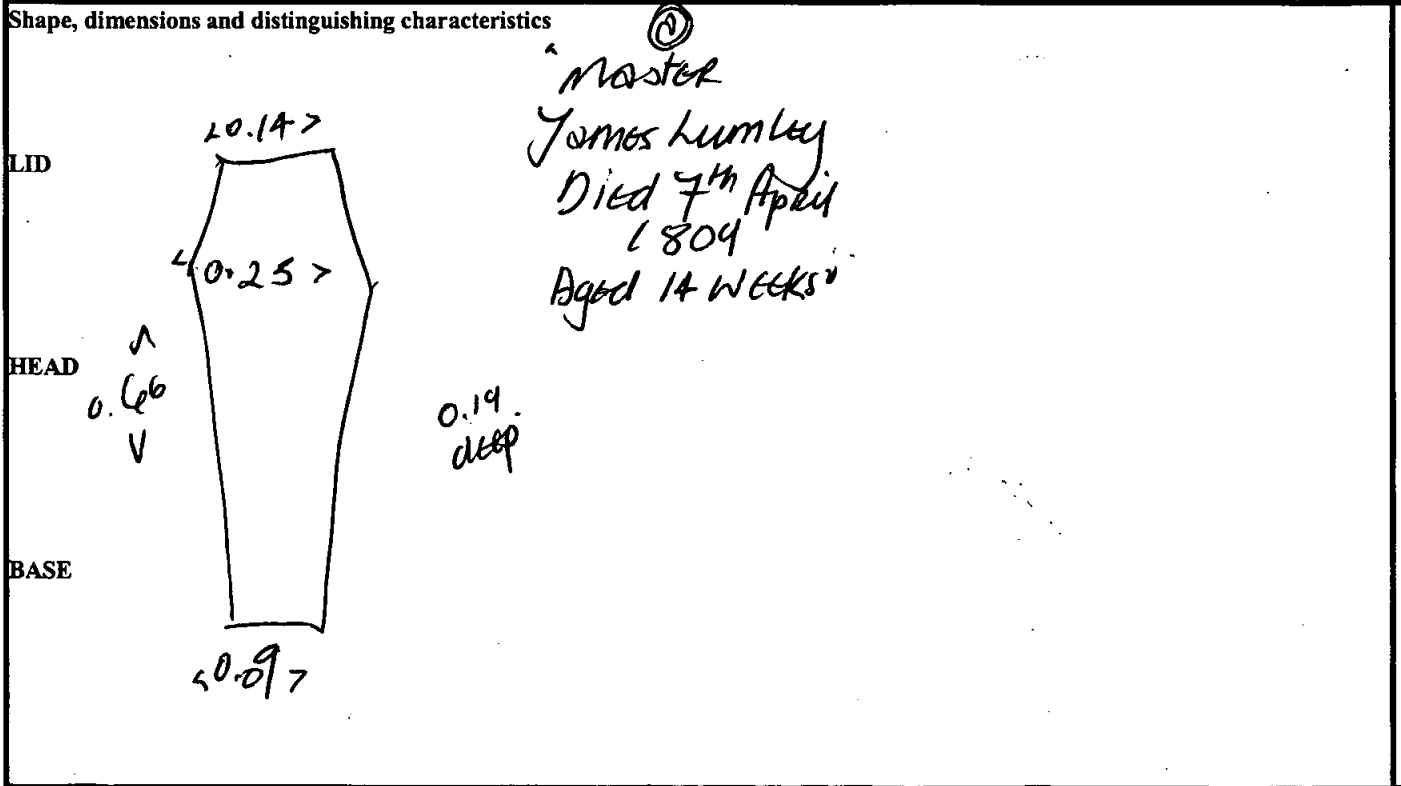

Recorder: MGL	Date: 22/11	Initials:
---------------	-------------	-----------

SITE <i>OLR00</i>		COFFIN RECORD SHEET	CONTEXT NO. <i>992</i>
Trench:	Additional sheets:	Treatment: <i>INTACT</i> <i>INFANT ⇒ NECROP</i>	
Site sub-div: <i>CRYPT</i>	Grave fills:		
Plan no: <i>7</i>	Grave cut:	Finds None	
Section no:	Skeleton:	Breastplate Grip	
Co-ordinates:	Matrix location: <i>in Bay 3</i>	Hinge Bracket	
Levels:	Preservation: <i>A</i>	Fixing nails Shroud pins	
Slide No.:	Neg No.:	Fabric Other finds	
Description <i>infant p.b. coffin, N → S, no name.</i>			
Discussion			
Shape, dimensions and distinguishing characteristics			
LID			
HEAD <i>^</i>			
BASE <i>✓</i>			
Recorder: <i>Mel</i>	Date: <i>22/11</i>	Initials:	



SITE	COFFIN RECORD SHEET	CONTEXT NO.
OLR 00	Additional sheets: 465 X 1	993 Treatment: BONES LIFTED
Trench:	Grave fills	
Site sub-div: SC	Grave cut:	Finds
Plan no: 6	Skeleton:	None
Section no:	Matrix location:	Breastplate
Co-ordinates:	959 q 993	Grip ✓
Levels	993 u/l 959	Hinge
Slide No.	Preservation:	Bracket
Neg No:		Fixing nails
Fabric		Shroud pins
Other finds		
Description		
E-W ADULT BURIAL. WOODEN COFFIN		
Fe STUDWORK. GRIPPLATE FRAGMENTS + GRIP PRESENT.		
Discussion		
THE CUT OF THE GRAVE CONTINUES MUCH DEEPER FROM THE LEVEL		
OF THE SKELETON. <del>BE</del> POSSIBLY DUE TO INITIAL COLLAPSE.		
LEVEL OF THE BASE OF THE GRAVE REPRESENTED BY T4 ON		
PLAN 6.		
Shape, dimensions and distinguishing characteristics		
LID		
Extra bone: R. Fibula - Adult		
Possibly belongs to 959		
HEAD		
BASE		
Recorder: DM	Date: 15/11/00	Initials:

Site Code

Context

**Outer Coffin**

Sample Ret.

OLR00

993

Recording Date ..... 13/2/01 .....

Associated Numbers .....

Condition .....

Dep. Plate

Legible

Inscription

Fabric lead  ormolou  brass  tin plated pewter  gilt tin   
 iron  silvered tin  enamelled  other ..... Sample Ret.

**Shape of dep. plate**

square  rectangle  shield  tapered  lozenge   
 cartouche  oval  other .....

**Upholstery**

colour ..... shoddy  velvet  other ..... Sample Ret.

**Construction**

butt joint  mitred  pitched  other .....

**Grip plate**

Fabric = ormolou  brass  tin plated pewter  gilt tin   
*on rec of grip - wood*

iron  silvered tin  enamelled  other ..... Sample Ret.   
*black*

**Grip**

Fabric = ormolou  brass  iron  x 1 Sample Ret.

**Design**

swag of rose  horseshoe  cherub's head  (20) plain

other ..... *↔ 0.12 ↓ 0.045* .....

**Grip bolts**

**Corner bolts**  Type = gilt brass  brass  iron

other ..... Sample Ret.

**Lid motifs**

other ..... Sample Ret.

**Escutcheons**

other ..... Sample Ret.

**Upholstery** ~~nails~~

*studs* brass  gilt brass  silvered brass  iron  enamelled

other ..... *1x 000 / 1x 000 / + 6 singles = 14 studs.* Sample Ret.

**Fixings**

panel nails  screws  hinges  lace  Sample Ret.

**Timber type** .....

Sample Ret.

**Interpretation / Comments**

.....  
 .....

SITE		COFFIN RECORD SHEET		CONTEXT NO.	
OLRoo				994	
Trench:	Additional sheets:		Treatment:		
Site sub-div: S.C	Grave fills		DNA / BONES		
Plan no: 6	Grave cut:		Finds		
Section no:	Skeleton: PARTIALLY ROTTEN - POSS. RESULT OF SANDUST		None		
Co-ordinates:	Matrix location: (994) (994) o/l (1006)		Breastplate ✓		
Levels:	Preservation: POOR		Grip		
Slide No.	Neg No:		Hinge		
			Bracket		
			Fixing nails		
			Shroud pins		
			Fabric		
			Other finds		

**Description** Pb ADULT COFFIN EAST - WEST ALIGNED. SOLDERED BREAST PLATE TO:-  
 ON STONEWORK / WOOD IN PLACES. ILLEGIBLE.

**Discussion** SANDUST

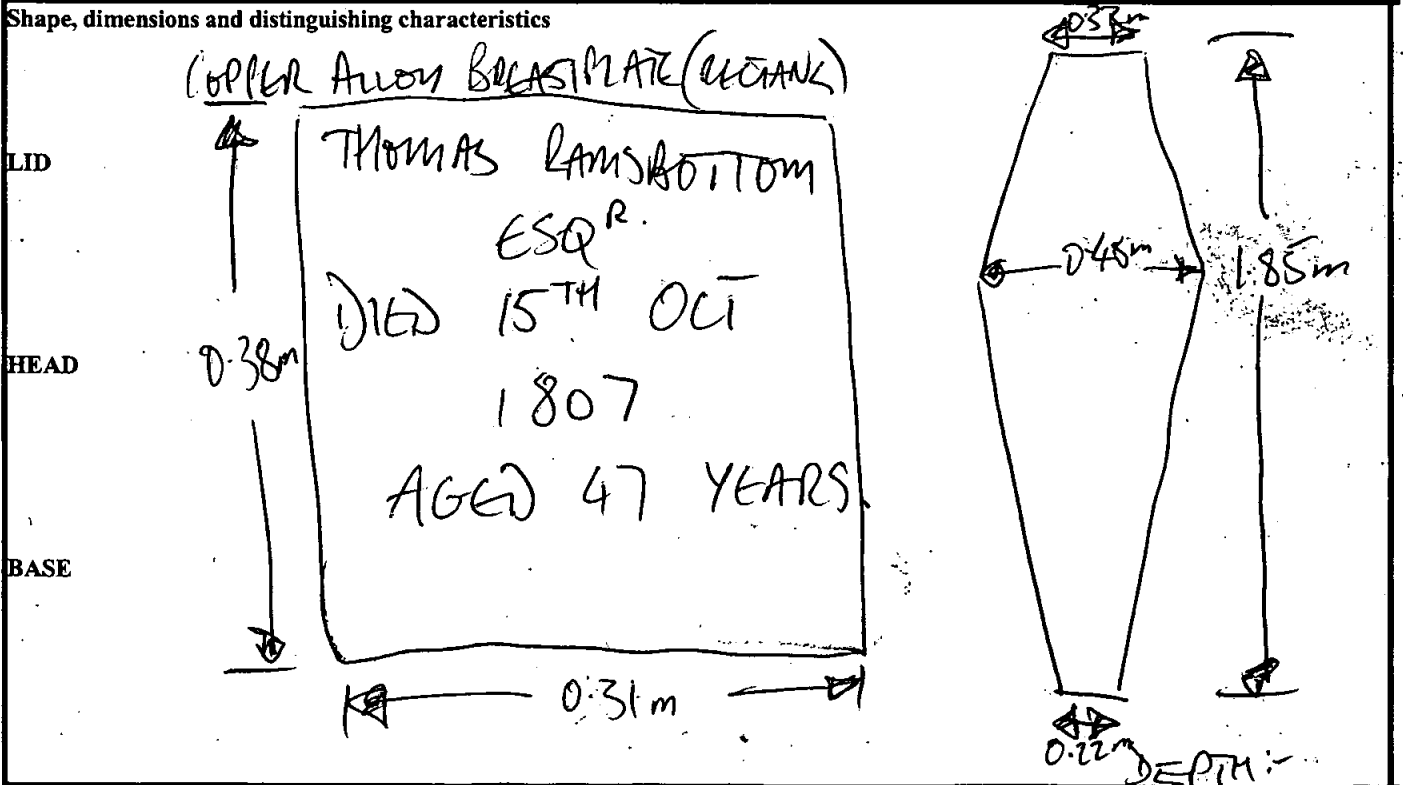

**Recorder:** Th **Date:** 15.11.00 **Initials:**

**Outer Coffin**

Sample Ret.

Site Code

Context

Recording Date ..... 15/11/00 .....

OL200

994

Associated Numbers .....

Condition ..... 2 .....

Dep. Plate

Legible

Inscription " THOMAS RAMSBOTTOM / ESQR / DIED 15<sup>th</sup> OCT<sup>R</sup> / 1807 / Aged 47 Years "

Fabric lead  ormolou  brass  tin plated pewter  gilt tin   
 iron  silvered tin  enamelled  other ..... Sample Ret.

**Shape of dep. plate**

square  rectangle  shield  tapered  lozenge   
 cartouche  oval  other .....

**Upholstery**

colour ..... shoddy  velvet  other *Bouze* ..... Sample Ret.

Construction butt joint  mitred  pitched  other .....

Grip plate  Fabric = ormolou  brass  tin plated pewter  gilt tin   
 iron  silvered tin  enamelled  other ..... Sample Ret.

Grip  Fabric = ormolou  *x2* brass  iron  Sample Ret.

Design swag of rose  *ⓐ*'s horseshoe  cherub's head  plain   
 other .....

Grip bolts  Corner bolts  Type = gilt brass  brass  iron   
 other ..... Sample Ret.

Lid motifs  other *new unguided tin* ..... Sample Ret.

Escutcheons  other *2x gilt brass (12)* ..... Sample Ret.

Upholstery *studs*  brass  gilt brass  silvered brass  iron  enamelled   
 other *1x 00000 = 5 studs in total* ..... Sample Ret.

Fixings  panel nails  screws  hinges  lace  Sample Ret.

Timber type ..... Sample Ret.

**Interpretation / Comments**

.....  
 .....

SITE <b>012 00</b>	COFFIN RECORD SHEET	CONTEXT NO. <b>995</b>
Trench:	Additional sheets:	Treatment: <del>UNPRESERVED</del> <b>BONES NOT TAKEN</b>
Site sub-div: <b>S.C.</b>	Grave fills:	Finds None
Plan no: <b>6</b>	Grave cut:	Breastplate <input checked="" type="checkbox"/>
Section no:	Skeleton:	Grip <input checked="" type="checkbox"/>
Co-ordinates:	Matrix location: <b>(995) o/l (997)</b>	Hinge
Levels:	Preservation:	Bracket
Slide No.:	Neg No.:	Fixing nails
		Shroud pins
		Fabric
		Other finds

**Description** E-W Pb-coffin. ADULT BURIAL.  
BREASTPLATE HEAVILY DAMAGED - NOT READABLE. COFFIN SPLIT AT HEAD-END ALLOWING RAIN WATER TO SETTLE IN THE COFFIN. SOME REMAINS OF FLESH TISSUE OR SIMILAR, SWEET STUFF.

**Discussion**  
HANDLES OVER TO NECROPOLIS. BONES NOT TAKEN FOR ANALYSIS. TWO WELL PRESERVED GRIPS KEPT. DOUBLE FE. STUDWORK ON SIX SIDE GRIP-PLATES.

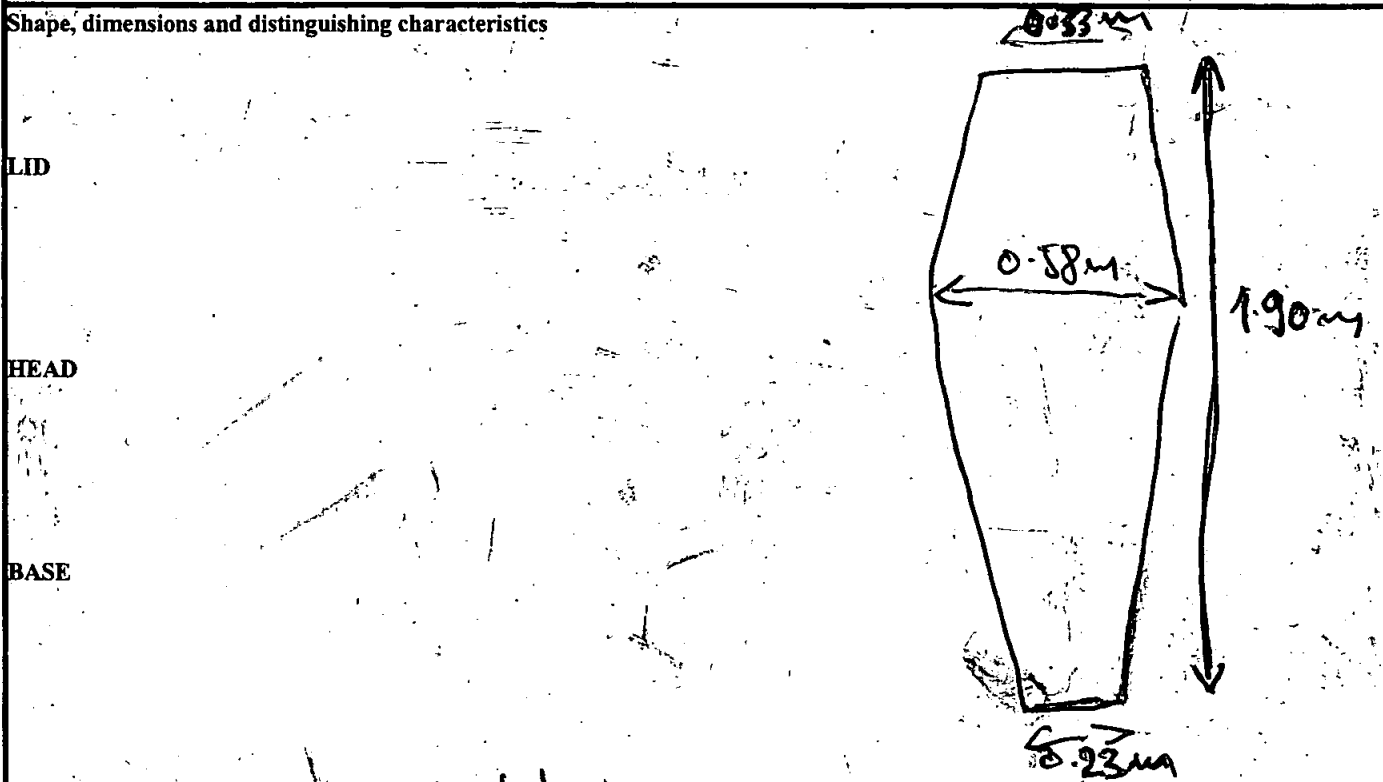

Recorder: <b>DM</b>	Date: <b>16/11/00</b>	Initials:
------------------------	--------------------------	-----------

Site Code

Context

**Outer Coffin**

Sample Ret.

OH200

995

Recording Date ..... 16/11/00 .....

Associated Numbers .....

Condition .....

Dep. Plate

Legible

Inscription

Fabric lead  ormolou  brass  tin plated pewter  gilt tin   
 iron  silvered tin  enamelled  other ..... Sample Ret.

**Shape of dep. plate**

square  rectangle  shield  tapered  lozenge   
 cartouche  oval  other .....

**Upholstery**

colour ..... shoddy  velvet  other *bolts on rev of bolts.* Sample Ret.

**Construction** butt joint  mitred  pitched  other .....

**Grip plate**  Fabric = ormolou  brass  tin plated pewter  gilt tin   
 iron  silvered tin  enamelled  other ..... Sample Ret.

**Grip**  Fabric = ormolou  brass  *x 3* iron  Sample Ret.   
*new type w/ 'bolt' terminals.*

**Design** swag of rose  horseshoe  cherub's head  plain   
 other .....

**Grip bolts**  **Corner bolts**  **Type =** gilt brass  brass  iron   
 other ..... Sample Ret.

**Lid motifs**  other ..... Sample Ret.

**Escutcheons**  other ..... Sample Ret.

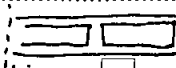
**Upholstery** *studs*  brass  gilt brass  silvered brass  iron  enamelled   
 other *2 x pieces / 1 x [stud] / 1 x [stud] = 25 studs in total* Sample Ret.   
*only 2 side panels surviving =>*  *not enough to id.*

**Fixings**  panel nails  screws  hinges  lace  Sample Ret.

**Timber type** ..... Sample Ret.

**Interpretation / Comments**

.....  
 .....

SITE <i>OLR00</i>		COFFIN RECORD SHEET	CONTEXT NO. <i>996</i>
Trench:	Additional sheets: <i>YES x 1.</i>	Treatment: <i>Bones collected.</i>	
Site sub-div: <i>SC</i>	Grave fills		
Plan no: <i>6</i>	Grave cut:	Finds None	
Section no:	Skeleton:	Breastplate Grip	
Co-ordinates:	Matrix location: <i>UNDER AND SUGGESTED TO THE SOUTH OF (934)</i>	Hinge Bracket	
Levels	Preservation: <i>skeleton - fair preservation &amp; reasonably complete</i>	Fixing nails Shroud pins	
Slide No.	Neg No:	Fabric Other finds	
Description <i>E-W Burial. wood coffin fragments - sturdwork.</i>			
Discussion			
Shape, dimensions and distinguishing characteristics			
LID			
HEAD			
BASE			
Recorder: <i>DS.</i>	Date: <i>16/11</i>	Initials: <i>B.</i>	

# Coffin Recording Sheet

Site Code

Context

**Outer Coffin**

Sample Ret.

*Ohloo*

*996*

Recording Date ..... *21/12/00* .....

Associated Numbers .....

Condition .....

Dep. Plate

Legible

Inscription

Fabric lead  ormolou  brass  tin plated pewter  gilt tin   
 iron  silvered tin  enamelled  other ..... Sample Ret.

**Shape of dep. plate**

square  rectangle  shield  tapered  lozenge   
 cartouche  oval  other .....

**Upholstery**

colour ..... shoddy  velvet  other ..... Sample Ret.

**Construction**

butt joint  mitred  pitched  other .....

Grip plate  Fabric = ormolou  brass  tin plated pewter  gilt tin   
 iron  silvered tin  enamelled  other ..... Sample Ret.

Grip  Fabric = ormolou  brass  iron  *x1*. Sample Ret.

Design swag of rose  horseshoe  cherub's head  *too conc. to id.* plain   
 other .....

Grip bolts  Corner bolts  Type = gilt brass  brass  iron   
 other ..... Sample Ret.

Lid motifs  other *1 x freq (14) cu alloy; gilt.* Sample Ret.

Escutcheons  other ..... Sample Ret.

Upholstery *studs*  brass  gilt brass  silvered brass  iron  enamelled   
 other *1 x  = 20 studs* Sample Ret.

Fixings  panel nails  screws  hinges  lace  Sample Ret.

Timber type ..... Sample Ret.

**Interpretation / Comments**

.....

.....



lb (PARTLY)

SITE <b>OLR 00</b>	COFFIN RECORD SHEET	CONTEXT NO. <b>997</b>
Trench:	Additional sheets: <b>YESXZ</b>	Treatment: <b>BONES LIFTED</b>
Site sub-div:	Grave fills	
Plan no:	Grave cut:	Finds None
Section no:	Skeleton:	Breastplate Grip
Co-ordinates:	Matrix location: <b>(997) 1/4 (995)</b>	Hinge Bracket
Levels	Preservation: <b>POOR</b>	Fixing nails Shroud pins
Slide No.	Neg No:	Fabric Other finds

**Description** E-W P5-COFFIN. INFANT BURIAL. BUTTER BREASTPLATE PRESENT BUT NOT READABLE. COFFIN HEAVILY DAMAGED AT THE TOP. HEAVY CORROSION.

**Discussion**

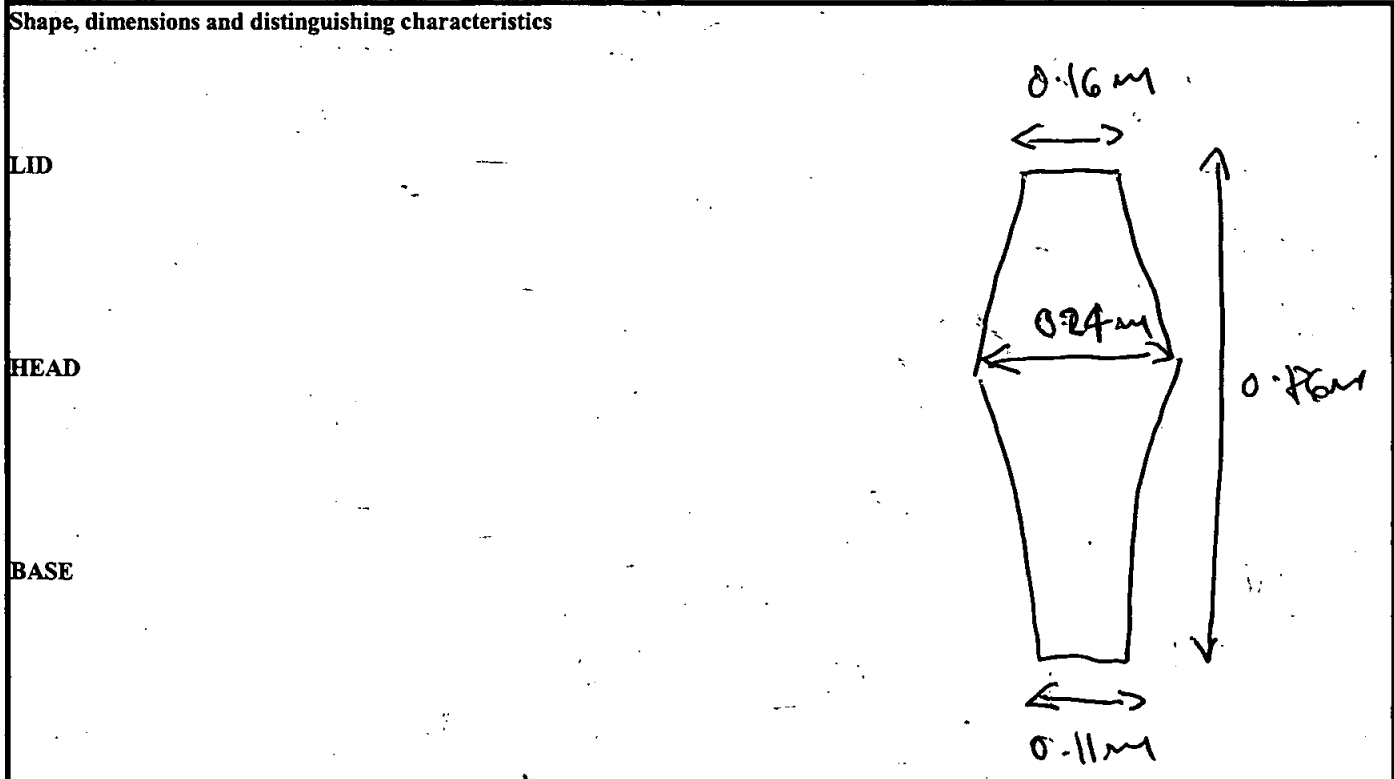

Recorder: **DM** Date: **16/11/08** Initials:

Site Code

Context

**Outer Coffin**

Sample Ret.

02R00

997

Recording Date ..... 8/12/00 .....

Associated Numbers .....

Condition ..... 2 .....

Dep. Plate

Legible  SH

Inscription

*\*Master/James? Douglas/MacCellum/Died? April/.../... Months  
... Days.*

Fabric lead  ormolou  brass  tin plated pewter  gilt tin   
iron  silvered tin  enamelled  other ..... Sample Ret.

**Shape of dep. plate**

square  rectangle  *inbents.* shield  tapered  lozenge   
cartouche  oval  other .....

**Upholstery**

colour ..... shoddy  velvet  other ..... Sample Ret.

**Construction**

butt joint  mitred  pitched  other .....

**Grip plate**

Fabric = ormolou  brass  tin plated pewter  gilt tin

iron  silvered tin  enamelled  other ..... Sample Ret.

**Grip**

Fabric = ormolou  brass  iron  Sample Ret.

**Design**

swag of rose  horseshoe  cherub's head  plain

other .....

**Grip bolts**

Corner bolts  Type = gilt brass  brass  iron

other ..... Sample Ret.

**Lid motifs**

other ..... Sample Ret.

**Escutcheons**

other ..... Sample Ret.

**Upholstery nails**

brass  gilt brass  silvered brass  iron  enamelled

other ..... Sample Ret.

**Fixings**

panel nails  screws  hinges  lace  Sample Ret.

**Timber type** .....

Sample Ret.

**Interpretation / Comments**

.....  
.....

SITE	OLR 00	COFFIN RECORD SHEET	CONTEXT NO.	998
Trench:		Additional sheets:	YES X 1	
Site sub-div:	S.C.	Grave fills	Treatment: BONES LIFTED	
Plan no:	6	Grave cut:	Finds None	
Section no:		Skeleton:	Breastplate Grip ✓	
Co-ordinates:		Matrix location:	Hinge Bracket	
Levels		Preservation:	Fixing nails Shroud pins	
Slide No.		Neg No:	Fabric Other finds	

Description E-W ADULT BURIAL. WOODEN COFFIN.  
GRIPS PRESENT AS WELL AS BOTTOM GRIP-PLATE.

Discussion

Shape, dimensions and distinguishing characteristics

LID

HEAD

BASE

Recorder:	BM	Date:	10 11 00	Initials:	
-----------	----	-------	----------	-----------	--

Site Code

Context

**Outer Coffin**

Sample Ret.

OKR00

998

Recording Date ..... 12/12 .....

Associated Numbers .....

Condition .....

Dep. Plate

Legible

Inscription

Fabric lead  ormolou  brass  tin plated pewter  gilt tin   
 iron  silvered tin  enamelled  other ..... Sample Ret.

**Shape of dep. plate**

square  rectangle  shield  tapered  lozenge   
 cartouche  oval  other .....

**Upholstery**

colour ..... shoddy  velvet  other ..... Sample Ret.

**Construction**

butt joint  mitred  pitched  other .....

Grip plate  Fabric = ormolou  brass  tin plated pewter  gilt tin   
 iron  silvered tin  enamelled  other ..... Sample Ret.   
*frag of cartouche on rev. of grip - not enough to id.*

Grip  Fabric = ormolou  brass  iron  x3 Sample Ret.

Design swag of rose  horseshoe  cherub's head  plain  *1/5*  
 other .....

Grip bolts  Corner bolts  Type = gilt brass  brass  iron

other ..... Sample Ret.

Lid motifs  other ..... Sample Ret.

Escutcheons  other ..... Sample Ret.

Upholstery *sheds*  brass  gilt brass  silvered brass  iron  enamelled

other ..... 1x 00 Sample Ret.

Fixings  panel nails  screws  hinges  lace  Sample Ret.

Timber type ..... Sample Ret.

**Interpretation / Comments**

.....  
 .....

SITE <u>OR 00</u>	COFFIN RECORD SHEET	CONTEXT NO. <u>999</u>
Trench:	Additional sheets:	Treatment: <u>BONES LIFTED</u>
Site sub-div: <u>S.E.</u>	Grave fills:	
Plan no: <u>6</u>	Grave cut:	Finds None
Section no:	Skeleton:	Breastplate Grip <input checked="" type="checkbox"/>
Co-ordinates:	Matrix location: <u>(999)</u>	Hinge Bracket
Levels:	Preservation: <u>POOR</u>	Fixing nails Shroud pins
Slide No.:	Neg No.:	Fabric Other finds

Description E-W ADULT BURIAL, WOODEN COFFIN  
CW ALLOY STUDWORK. GRIPS PRESENT, GRAVE APPEARS TO  
BE HEAVILY TRENCHATED ACROSS TOP PROFILE, HOWEVER  
Discussion THIS DOES NOT SEEM TO BE DONE DURING DIGGING  
OF LATER GRAVE.

Shape, dimensions and distinguishing characteristics

LID

HEAD

BASE

Recorder: <u>DM</u>	Date: <u>16/11/00</u>	Initials:
---------------------	-----------------------	-----------

Site Code

Context

**Outer Coffin**

Sample Ret.

OKR00

999

Recording Date ..... 22/2/01 .....

Associated Numbers .....

Condition .....

Dep. Plate

Legible

Inscription

Fabric lead  ormolou  brass  tin plated pewter  gilt tin   
 iron  silvered tin  enamelled  other ..... Sample Ret.

**Shape of dep. plate**

square  rectangle  shield  tapered  lozenge   
 cartouche  oval  other .....

**Upholstery**

colour ..... shoddy  velvet  other ..... Sample Ret.

**Construction**

butt joint  mitred  pitched  other .....

Grip plate  Fabric = ormolou  brass  tin plated pewter  gilt tin   
 iron  silvered tin  enamelled  other ..... Sample Ret.

Grip  Fabric = ormolou  brass  iron  x4 Sample Ret.

Design swag of rose  horseshoe  cherub's head  plain  (2d)

other .....

Grip bolts  Corner bolts  Type = gilt brass  brass  iron

other ..... Sample Ret.

Lid motifs  other ..... Sample Ret.

Escutcheons  other ..... Sample Ret.

Upholstery <sup>studs</sup> nails  brass  gilt brass  silvered brass  iron  enamelled

other ..... 1 x piece ~~studs~~ = 16 studs. Sample Ret.

Fixings  panel nails  screws  hinges  lace  Sample Ret.

Timber type ..... Sample Ret.

**Interpretation / Comments**

.....  
 .....

db (partly)

SITE OLR 08	COFFIN RECORD SHEET	CONTEXT NO. 1000
Trench: <del>OLR 08</del>	Additional sheets: YES x 1.	Treatment: BONES LIFTED
Site sub-div: SC	Grave fills	
Plan no: 6	Grave cut:	Finds None
Section no:	Skeleton:	Breastplate Grip <input checked="" type="checkbox"/>
Co-ordinates:	Matrix location: <del>OLR 08</del> 1000 J/L 999	Hinge Bracket
Levels	Preservation:	Fixing nails Shroud pins
Slide No.	Neg No:	Fabric Other finds

Description E-W ADULT BURIAL. WOODEN COFFIN.  
 C-AND STUDWORK. FE GRIPS PRESENT.  
 GRAVE HEAVILY TRUNCATED BY OVERDIGGING (999).  
 AS A CONSEQUENCE WHOLE OF TORSO AND SKULL ARE MISSING.  
 Discussion ARMS AND LOWER BODY PRESENT AND

Shape, dimensions and distinguishing characteristics

LID

HEAD

BASE

Recorder: DM	Date: 16/11/00	Initials:
-----------------	-------------------	-----------

**Outer Coffin**

Sample Ret.

Site Code

Context

*04200*

*1000*

Recording Date *12/12/00*

Associated Numbers .....

Condition .....

Dep. Plate

Legible

Inscription

**Fabric** lead  ormolou  brass  tin plated pewter  gilt tin   
 iron  silvered tin  enamelled  other ..... Sample Ret.

**Shape of dep. plate**

square  rectangle  shield  tapered  lozenge   
 cartouche  oval  other .....

**Upholstery**

colour ..... shoddy  velvet  other ..... Sample Ret.

**Construction**

butt joint  mitred  pitched  other .....

**Grip plate**  **Fabric =** ormolou  brass  tin plated pewter  gilt tin   
 iron  silvered tin  enamelled  other ..... Sample Ret.

**Grip**  **Fabric =** ormolou  brass  iron  *x2. to conc. to id.* Sample Ret.

**Design** swag of rose  horseshoe  cherub's head  plain   
 other .....

**Grip bolts**  **Corner bolts**  **Type =** gilt brass  brass  iron

other ..... Sample Ret.

**Lid motifs**  other ..... Sample Ret.

**Escutcheons**  other ..... Sample Ret.

**Upholstery nails**  brass  gilt brass  silvered brass  iron  enamelled

other ..... Sample Ret.

**Fixings**  panel nails  screws  hinges  lace  Sample Ret.

**Timber type** ..... Sample Ret.

**Interpretation / Comments**

.....  
 .....



db

SITE	OLR 00	COFFIN RECORD SHEET	CONTEXT NO.	1001
Trench:		Additional sheets:	Yes x1	Treatment:
Site sub-div:	S.C.	Grave fills		BONES LIFTED
Plan no:	6	Grave cut:		Finds
Section no:		Skeleton:		None
Co-ordinates:		Matrix location:	(1001) U/L (1000)	Breastplate
Levels		Preservation:	POOR	Grip
Slide No.		Neg No:		Hinge
Description				Bracket
E-W ADULT BURIAL. WOODEN COFFIN. Cu-ALLOY STOWORK. BURIAL DOES NOT SEEM TO BE TREATED BY (1000) WHICH OVERLIES IT. SKUL, LIKE (1000) ONLY LOWER BODY AND PARTIAL ARMS PRESENT.				Fixing nails
Discussion				Shroud pins
Shape, dimensions and distinguishing characteristics				
LID				
HEAD				
BASE				
Recorder:	DM	Date:	16 / 11 / 00	Initials:

**Outer Coffin**

Sample Ret.

Site Code

Context

Recording Date ..... 6/12/00 .....

02200

1001

Associated Numbers .....

Condition .....

Dep. Plate

Legible

Inscription

Fabric lead  ormolou  brass  tin plated pewter  gilt tin   
 iron  silvered tin  enamelled  other ..... Sample Ret.

**Shape of dep. plate**

square  rectangle  shield  tapered  lozenge   
 cartouche  oval  other .....

**Upholstery**

colour ..... shoddy  velvet  other ..... Sample Ret.

**Construction**

butt joint  mitred  pitched  other .....

Grip plate  Fabric = ormolou  brass  tin plated pewter  gilt tin   
 iron  silvered tin  enamelled  other ..... Sample Ret.   
*knags on rev of grip-wood*

Grip  Fabric = ormolou  brass  iron  *X1* Sample Ret.

Design swag of rose  horseshoe  cherub's head  (3b) plain   
 other .....

Grip bolts  Corner bolts  Type = gilt brass  brass  iron

other ..... Sample Ret.

Lid motifs  other ..... Sample Ret.

Escutcheons  other ..... Sample Ret.

Upholstery <sup>studs</sup> nails  brass  gilt brass  silvered brass  iron  enamelled   
 other *1 x piece 0000000000 = 17 studs on total.* Sample Ret.

Fixings  panel nails  screws  hinges  lace  Sample Ret.

Timber type ..... Sample Ret.

**Interpretation / Comments**

.....  
 .....

db

SITE <b>OLR 00</b>		COFFIN RECORD SHEET		CONTEXT NO. <b>1002</b>	
Trench:		Additional sheets:		Treatment:	
Site sub-div: <b>S.E.</b>		Grave fills		<b>BONES LIFTED</b>	
Plan no: <b>6</b>		Grave cut:		Finds	
Section no:		Skeleton:		None	
Co-ordinates:		Matrix location:		Breastplate	
Levels		Preservation: <b>GOOD</b>		Grip	
Slide No.		Neg No:		Hinge	
Description		<b>1002</b> u/L <b>1001</b>		Bracket	
Discussion		<b>E-W ADULT BURIAL, WOODEN COFFIN.</b> <b>ON MUD STONEWORK.</b>		Fixing nails	
Shape, dimensions and distinguishing characteristics				Shroud pins	
LID				Fabric	
HEAD				Other finds	
BASE					
Recorder: <b>BM</b>		Date: <b>16/11/00</b>		Initials:	

SITE		COFFIN RECORD SHEET		CONTEXT NO.	
OUR 00				1003	
Trench:		Additional sheets: YESX1		Treatment:	
Site sub-div: S.E.		Grave fills		BONES LIFTED	
Plan no: 6		Grave cut:		Finds	
Section no:		Skeleton:		None	
Co-ordinates:		Matrix location:		Breastplate	
Levels		Preservation: GOOD		Grip	
Slide No.		Neg No:		Hinge	
Description		E-W JUVENILE BURIAL (YOUNG ADULT?), WOODEN COFFIN.		Bracket	
Discussion		CW MUD STUDWORK, VERY CLOSE TO 1004 (NEXT TO IT), SHOULD BE LOOKED AT TOGETHER WITH 1004.		Fixing nails	
Shape, dimensions and distinguishing characteristics				Shroud pins	
LID				Fabric	
HEAD				Other finds	
BASE					
Recorder: DM		Date: 16/11/00		Initials:	

# Coffin Recording Sheet

**Outer Coffin**

Sample Ret.

Site Code

Context

Recording Date ..... 15/12 .....

OR000

1003

Associated Numbers .....

Condition .....

Dep. Plate

Legible

Inscription

Fabric lead  ormolou  brass  tin plated pewter  gilt tin   
 iron  silvered tin  enamelled  other ..... Sample Ret.

**Shape of dep. plate**

square  rectangle  shield  tapered  lozenge   
 cartouche  oval  other .....

**Upholstery**

colour ..... shoddy  velvet  other ..... Sample Ret.

**Construction**

butt joint  mitred  pitched  other .....

Grip plate  Fabric = ormolou  brass  tin plated pewter  gilt tin   
 iron  silvered tin  enamelled  other ..... Sample Ret.

Grip  Fabric = ormolou  brass  iron  OXI Sample Ret.

Design swag of rose  horseshoe  cherub's head  3b plain   
 other .....

Grip bolts  Corner bolts  Type = gilt brass  brass  iron   
 other ..... Sample Ret.

Lid motifs  other ..... Sample Ret.

Escutcheons  other ..... Sample Ret.

Upholstery nails  brass  gilt brass  silvered brass  iron  enamelled   
 other ..... Sample Ret.

Fixings  panel nails  screws  hinges  lace  Sample Ret.

Timber type ..... Sample Ret.

**Interpretation / Comments**

.....  
 .....

db

SITE	OLR 00	COFFIN RECORD SHEET	CONTEXT NO.	1004
Trench:		Additional sheets:	4x3 x 1	Treatment:
Site sub-div:	S.C.	Grave fills		BONES LIFTED
Plan no:	6	Grave cut:		Finds
Section no:		Skeleton:		None
Co-ordinates:		Matrix location:		Breastplate
Levels		Preservation:	GOOD	Grip ✓
Slide No.		Neg No:		Hinge
				Bracket
				Fixing nails
				Shroud pins
				Fabric
				Other finds

**Description** E-W JUVENILE/YOUNG ADULT BURIAL. WOODEN COFFIN. CW-ANOP STUOVERK. SKUL PRESENT. SKULL MISSING NEXT TO AND JUST BELOW (1003). SHOULD BE LOOKED AT TOGETHER WITH (1003) DUE TO POSSIBILITY OF MIXING.

**Discussion**

Shape, dimensions and distinguishing characteristics

LID

HEAD

BASE

Recorder:	DM	Date:	16/11/00	Initials:
-----------	----	-------	----------	-----------

Site Code

Context

**Outer Coffin**

Sample Ret.

OR200

1004

Recording Date ..... 6/12/00

Associated Numbers .....

Condition .....

Dep. Plate

Legible

Inscription

Fabric lead  ormolou  brass  tin plated pewter  gilt tin   
 iron  silvered tin  enamelled  other ..... Sample Ret.

**Shape of dep. plate**

square  rectangle  shield  tapered  lozenge   
 cartouche  oval  other .....

**Upholstery**

colour ..... shoddy  velvet  other ..... Sample Ret.

**Construction** ..... butt joint  mitred  pitched  other .....

**Grip plate**  Fabric = ormolou  brass  tin plated pewter  gilt tin   
 iron  *Progs on REV. of grip-und.* silvered tin  enamelled  other ..... Sample Ret.

**Grip**  Fabric = ormolou  brass  iron  *x2* Sample Ret.

**Design** ..... swag of rose  horseshoe  cherub's head  *(36)1s* plain   
 other .....

**Grip bolts**  **Corner bolts**  **Type =** gilt brass  brass  iron   
 other ..... Sample Ret.

**Lid motifs**  other ..... Sample Ret.

**Escutcheons**  other ..... Sample Ret.

**Upholstery nails**  brass  gilt brass  silvered brass  iron  enamelled   
 other ..... Sample Ret.

**Fixings**  panel nails  screws  hinges  lace  Sample Ret.

**Timber type** ..... Sample Ret.

**Interpretation / Comments**

.....  
 .....

SITE <b>OLR 00</b>		CONTEXT RECORD		Context No. <b>1005</b>		
Trench		Additional Sheets: <b>—</b>		Type <b>WT</b>		
Site sub-div <b>SC</b>	Context Type: <b>Deposit / Cut / Structure</b>	Check Lists:				
Structure No.	Overlain by:	DEPOSIT:				
Plan No.	Abutted by:	1.compaction 2.colour 3.composition 4.inclusions 5.thickness 6.extent 7.comments 8.method & conditions				
Section No.	Cut by:	CUT:				
Co-Ordinates	Filled by: <b>1006</b>	1.shape in plan 2.base/sides/top profile 3.dimension and depth 4.sketch 5.truncation 6.fill nos 7.other comments				
Level	Same as:	MASONRY:				
Slide No.	Part of:	1.materials 2.size of bricks etc 3.finish of stones 4.coursing/bond 5.form 6.faces 7.bond 8.dimensions as found 9.other comments				
Neg No.	Consists of:					
Matrix location	Overlies:					
	Butts:					
	Cuts:					
	Fill of:					
	Relationships uncertain					
Description (See check lists):		STRATIGRAPHIC MATRIX				
<p><b>OVAL (S-N) PIT AT THE BOTTOM OF THE MACHINE SLOT - BELOW LEVEL OF SOUTH CHURCH YARD. PIT HAS NOT BEEN EXCAVATED, JUST RECORDED IN PLAN AND POTTERY RETRIEVED.</b></p>		<pre> graph TD     A[ ] --- B[ ]     B --- C[1006]     C --- D[ ]     D --- E[ ]     E --- F[ ]     F --- G[ ]     G --- H[ ]     H --- I[ ]     I --- J[ ]     J --- K[ ]     K --- L[ ]     L --- M[ ]     M --- N[ ]     N --- O[ ]     O --- P[ ]     P --- Q[ ]     Q --- R[ ]     R --- S[ ]     S --- T[ ]     T --- U[ ]     U --- V[ ]     V --- W[ ]     W --- X[ ]     X --- Y[ ]     Y --- Z[ ]     Z --- AA[ ]     AA --- AB[ ]     AB --- AC[ ]     AC --- AD[ ]     AD --- AE[ ]     AE --- AF[ ]     AF --- AG[ ]     AG --- AH[ ]     AH --- AI[ ]     AI --- AJ[ ]     AJ --- AK[ ]     AK --- AL[ ]     AL --- AM[ ]     AM --- AN[ ]     AN --- AO[ ]     AO --- AP[ ]     AP --- AQ[ ]     AQ --- AR[ ]     AR --- AS[ ]     AS --- AT[ ]     AT --- AU[ ]     AU --- AV[ ]     AV --- AW[ ]     AW --- AX[ ]     AX --- AY[ ]     AY --- AZ[ ]     AZ --- BA[ ]     BA --- BB[ ]     BB --- BC[ ]     BC --- BD[ ]     BD --- BE[ ]     BE --- BF[ ]     BF --- BG[ ]     BG --- BH[ ]     BH --- BI[ ]     BI --- BJ[ ]     BJ --- BK[ ]     BK --- BL[ ]     BL --- BM[ ]     BM --- BN[ ]     BN --- BO[ ]     BO --- BP[ ]     BP --- BQ[ ]     BQ --- BR[ ]     BR --- BS[ ]     BS --- BT[ ]     BT --- BU[ ]     BU --- BV[ ]     BV --- BW[ ]     BW --- BX[ ]     BX --- BY[ ]     BY --- BZ[ ]     BZ --- CA[ ]     CA --- CB[ ]     CB --- CC[ ]     CC --- CD[ ]     CD --- CE[ ]     CE --- CF[ ]     CF --- CG[ ]     CG --- CH[ ]     CH --- CI[ ]     CI --- CJ[ ]     CJ --- CK[ ]     CK --- CL[ ]     CL --- CM[ ]     CM --- CN[ ]     CN --- CO[ ]     CO --- CP[ ]     CP --- CQ[ ]     CQ --- CR[ ]     CR --- CS[ ]     CS --- CT[ ]     CT --- CU[ ]     CU --- CV[ ]     CV --- CW[ ]     CW --- CX[ ]     CX --- CY[ ]     CY --- CZ[ ]     CZ --- DA[ ]     DA --- DB[ ]     DB --- DC[ ]     DC --- DD[ ]     DD --- DE[ ]     DE --- DF[ ]     DF --- DG[ ]     DG --- DH[ ]     DH --- DI[ ]     DI --- DJ[ ]     DJ --- DK[ ]     DK --- DL[ ]     DL --- DM[ ]     DM --- DN[ ]     DN --- DO[ ]     DO --- DP[ ]     DP --- DQ[ ]     DQ --- DR[ ]     DR --- DS[ ]     DS --- DT[ ]     DT --- DU[ ]     DU --- DV[ ]     DV --- DW[ ]     DW --- DX[ ]     DX --- DY[ ]     DY --- DZ[ ]     DZ --- EA[ ]     EA --- EB[ ]     EB --- EC[ ]     EC --- ED[ ]     ED --- EE[ ]     EE --- EF[ ]     EF --- EG[ ]     EG --- EH[ ]     EH --- EI[ ]     EI --- EJ[ ]     EJ --- EK[ ]     EK --- EL[ ]     EL --- EM[ ]     EM --- EN[ ]     EN --- EO[ ]     EO --- EP[ ]     EP --- EQ[ ]     EQ --- ER[ ]     ER --- ES[ ]     ES --- ET[ ]     ET --- EU[ ]     EU --- EV[ ]     EV --- EW[ ]     EW --- EX[ ]     EX --- EY[ ]     EY --- EZ[ ]     EZ --- FA[ ]     FA --- FB[ ]     FB --- FC[ ]     FC --- FD[ ]     FD --- FE[ ]     FE --- FF[ ]     FF --- FG[ ]     FG --- FH[ ]     FH --- FI[ ]     FI --- FJ[ ]     FJ --- FK[ ]     FK --- FL[ ]     FL --- FM[ ]     FM --- FN[ ]     FN --- FO[ ]     FO --- FP[ ]     FP --- FQ[ ]     FQ --- FR[ ]     FR --- FS[ ]     FS --- FT[ ]     FT --- FU[ ]     FU --- FV[ ]     FV --- FW[ ]     FW --- FX[ ]     FX --- FY[ ]     FY --- FZ[ ]     FZ --- GA[ ]     GA --- GB[ ]     GB --- GC[ ]     GC --- GD[ ]     GD --- GE[ ]     GE --- GF[ ]     GF --- GG[ ]     GG --- GH[ ]     GH --- GI[ ]     GI --- GJ[ ]     GJ --- GK[ ]     GK --- GL[ ]     GL --- GM[ ]     GM --- GN[ ]     GN --- GO[ ]     GO --- GP[ ]     GP --- GQ[ ]     GQ --- GR[ ]     GR --- GS[ ]     GS --- GT[ ]     GT --- GU[ ]     GU --- GV[ ]     GV --- GW[ ]     GW --- GX[ ]     GX --- GY[ ]     GY --- GZ[ ]     GZ --- HA[ ]     HA --- HB[ ]     HB --- HC[ ]     HC --- HD[ ]     HD --- HE[ ]     HE --- HF[ ]     HF --- HG[ ]     HG --- HH[ ]     HH --- HI[ ]     HI --- HJ[ ]     HJ --- HK[ ]     HK --- HL[ ]     HL --- HM[ ]     HM --- HN[ ]     HN --- HO[ ]     HO --- HP[ ]     HP --- HQ[ ]     HQ --- HR[ ]     HR --- HS[ ]     HS --- HT[ ]     HT --- HU[ ]     HU --- HV[ ]     HV --- HW[ ]     HW --- HX[ ]     HX --- HY[ ]     HY --- HZ[ ]     HZ --- IA[ ]     IA --- IB[ ]     IB --- IC[ ]     IC --- ID[ ]     ID --- IE[ ]     IE --- IF[ ]     IF --- IG[ ]     IG --- IH[ ]     IH --- II[ ]     II --- IJ[ ]     IJ --- IK[ ]     IK --- IL[ ]     IL --- IM[ ]     IM --- IN[ ]     IN --- IO[ ]     IO --- IP[ ]     IP --- IQ[ ]     IQ --- IR[ ]     IR --- IS[ ]     IS --- IT[ ]     IT --- IU[ ]     IU --- IV[ ]     IV --- IW[ ]     IW --- IX[ ]     IX --- IY[ ]     IY --- IZ[ ]     IZ --- JA[ ]     JA --- JB[ ]     JB --- JC[ ]     JC --- JD[ ]     JD --- JE[ ]     JE --- JF[ ]     JF --- JG[ ]     JG --- JH[ ]     JH --- JI[ ]     JI --- JJ[ ]     JJ --- JK[ ]     JK --- JL[ ]     JL --- JM[ ]     JM --- JN[ ]     JN --- JO[ ]     JO --- JP[ ]     JP --- JQ[ ]     JQ --- JR[ ]     JR --- JS[ ]     JS --- JT[ ]     JT --- JU[ ]     JU --- JV[ ]     JV --- JW[ ]     JW --- JX[ ]     JX --- JY[ ]     JY --- JZ[ ]     JZ --- KA[ ]     KA --- KB[ ]     KB --- KC[ ]     KC --- KD[ ]     KD --- KE[ ]     KE --- KF[ ]     KF --- KG[ ]     KG --- KH[ ]     KH --- KI[ ]     KI --- KJ[ ]     KJ --- KL[ ]     KL --- KM[ ]     KM --- KN[ ]     KN --- KO[ ]     KO --- KP[ ]     KP --- KQ[ ]     KQ --- KR[ ]     KR --- KS[ ]     KS --- KT[ ]     KT --- KU[ ]     KU --- KV[ ]     KV --- KW[ ]     KW --- KX[ ]     KX --- KY[ ]     KY --- KZ[ ]     KZ --- LA[ ]     LA --- LB[ ]     LB --- LC[ ]     LC --- LD[ ]     LD --- LE[ ]     LE --- LF[ ]     LF --- LG[ ]     LG --- LH[ ]     LH --- LI[ ]     LI --- LJ[ ]     LJ --- LK[ ]     LK --- LL[ ]     LL --- LM[ ]     LM --- LN[ ]     LN --- LO[ ]     LO --- LP[ ]     LP --- LQ[ ]     LQ --- LR[ ]     LR --- LS[ ]     LS --- LT[ ]     LT --- LU[ ]     LU --- LV[ ]     LV --- LW[ ]     LW --- LX[ ]     LX --- LY[ ]     LY --- LZ[ ]     LZ --- MA[ ]     MA --- MB[ ]     MB --- MC[ ]     MC --- MD[ ]     MD --- ME[ ]     ME --- MF[ ]     MF --- MG[ ]     MG --- MH[ ]     MH --- MI[ ]     MI --- MJ[ ]     MJ --- MK[ ]     MK --- ML[ ]     ML --- MN[ ]     MN --- MO[ ]     MO --- MP[ ]     MP --- MQ[ ]     MQ --- MR[ ]     MR --- MS[ ]     MS --- MT[ ]     MT --- MU[ ]     MU --- MV[ ]     MV --- MW[ ]     MW --- MX[ ]     MX --- MY[ ]     MY --- MZ[ ]     MZ --- NA[ ]     NA --- NB[ ]     NB --- NC[ ]     NC --- ND[ ]     ND --- NE[ ]     NE --- NF[ ]     NF --- NG[ ]     NG --- NH[ ]     NH --- NI[ ]     NI --- NJ[ ]     NJ --- NK[ ]     NK --- NL[ ]     NL --- NM[ ]     NM --- NO[ ]     NO --- NP[ ]     NP --- NQ[ ]     NQ --- NR[ ]     NR --- NS[ ]     NS --- NT[ ]     NT --- NU[ ]     NU --- NV[ ]     NV --- NW[ ]     NW --- NX[ ]     NX --- NY[ ]     NY --- NZ[ ]     NZ --- OA[ ]     OA --- OB[ ]     OB --- OC[ ]     OC --- OD[ ]     OD --- OE[ ]     OE --- OF[ ]     OF --- OG[ ]     OG --- OH[ ]     OH --- OI[ ]     OI --- OJ[ ]     OJ --- OK[ ]     OK --- OL[ ]     OL --- OM[ ]     OM --- ON[ ]     ON --- OO[ ]     OO --- OP[ ]     OP --- OQ[ ]     OQ --- OR[ ]     OR --- OS[ ]     OS --- OT[ ]     OT --- OU[ ]     OU --- OV[ ]     OV --- OW[ ]     OW --- OX[ ]     OX --- OY[ ]     OY --- OZ[ ]     OZ --- PA[ ]     PA --- PB[ ]     PB --- PC[ ]     PC --- PD[ ]     PD --- PE[ ]     PE --- PF[ ]     PF --- PG[ ]     PG --- PH[ ]     PH --- PI[ ]     PI --- PJ[ ]     PJ --- PK[ ]     PK --- PL[ ]     PL --- PM[ ]     PM --- PN[ ]     PN --- PO[ ]     PO --- PP[ ]     PP --- PQ[ ]     PQ --- PR[ ]     PR --- PS[ ]     PS --- PT[ ]     PT --- PU[ ]     PU --- PV[ ]     PV --- PW[ ]     PW --- PX[ ]     PX --- PY[ ]     PY --- PZ[ ]     PZ --- QA[ ]     QA --- QB[ ]     QB --- QC[ ]     QC --- QD[ ]     QD --- QE[ ]     QE --- QF[ ]     QF --- QG[ ]     QG --- QH[ ]     QH --- QI[ ]     QI --- QJ[ ]     QJ --- QK[ ]     QK --- QL[ ]     QL --- QM[ ]     QM --- QN[ ]     QN --- QO[ ]     QO --- QP[ ]     QP --- QQ[ ]     QQ --- QR[ ]     QR --- QS[ ]     QS --- QT[ ]     QT --- QU[ ]     QU --- QV[ ]     QV --- QW[ ]     QW --- QX[ ]     QX --- QY[ ]     QY --- QZ[ ]     QZ --- RA[ ]     RA --- RB[ ]     RB --- RC[ ]     RC --- RD[ ]     RD --- RE[ ]     RE --- RF[ ]     RF --- RG[ ]     RG --- RH[ ]     RH --- RI[ ]     RI --- RJ[ ]     RJ --- RK[ ]     RK --- RL[ ]     RL --- RM[ ]     RM --- RN[ ]     RN --- RO[ ]     RO --- RP[ ]     RP --- RQ[ ]     RQ --- RR[ ]     RR --- RS[ ]     RS --- RT[ ]     RT --- RU[ ]     RU --- RV[ ]     RV --- RW[ ]     RW --- RX[ ]     RX --- RY[ ]     RY --- RZ[ ]     RZ --- SA[ ]     SA --- SB[ ]     SB --- SC[ ]     SC --- SD[ ]     SD --- SE[ ]     SE --- SF[ ]     SF --- SG[ ]     SG --- SH[ ]     SH --- SI[ ]     SI --- SJ[ ]     SJ --- SK[ ]     SK --- SL[ ]     SL --- SM[ ]     SM --- SN[ ]     SN --- SO[ ]     SO --- SP[ ]     SP --- SQ[ ]     SQ --- SR[ ]     SR --- SS[ ]     SS --- ST[ ]     ST --- SU[ ]     SU --- SV[ ]     SV --- SW[ ]     SW --- SX[ ]     SX --- SY[ ]     SY --- SZ[ ]     SZ --- TA[ ]     TA --- TB[ ]     TB --- TC[ ]     TC --- TD[ ]     TD --- TE[ ]     TE --- TF[ ]     TF --- TG[ ]     TG --- TH[ ]     TH --- TI[ ]     TI --- TJ[ ]     TJ --- TK[ ]     TK --- TL[ ]     TL --- TM[ ]     TM --- TN[ ]     TN --- TO[ ]     TO --- TP[ ]     TP --- TQ[ ]     TQ --- TR[ ]     TR --- TS[ ]     TS --- TT[ ]     TT --- TU[ ]     TU --- TV[ ]     TV --- TW[ ]     TW --- TX[ ]     TX --- TY[ ]     TY --- TZ[ ]     TZ --- UA[ ]     UA --- UB[ ]     UB --- UC[ ]     UC --- UD[ ]     UD --- UE[ ]     UE --- UF[ ]     UF --- UG[ ]     UG --- UH[ ]     UH --- UI[ ]     UI --- UJ[ ]     UJ --- UK[ ]     UK --- UL[ ]     UL --- UM[ ]     UM --- UN[ ]     UN --- UO[ ]     UO --- UP[ ]     UP --- UQ[ ]     UQ --- UR[ ]     UR --- US[ ]     US --- UT[ ]     UT --- UJ[ ]     UJ --- UV[ ]     UV --- UW[ ]     UW --- UX[ ]     UX --- UY[ ]     UY --- UZ[ ]     UZ --- VA[ ]     VA --- VB[ ]     VB --- VC[ ]     VC --- VD[ ]     VD --- VE[ ]     VE --- VF[ ]     VF --- VG[ ]     VG --- VH[ ]     VH --- VI[ ]     VI --- VJ[ ]     VJ --- VK[ ]     VK --- VL[ ]     VL --- VM[ ]     VM --- VN[ ]     VN --- VO[ ]     VO --- VP[ ]     VP --- VQ[ ]     VQ --- VR[ ]     VR --- VS[ ]     VS --- VT[ ]     VT --- VU[ ]     VU --- VV[ ]     VV --- VW[ ]     VW --- VX[ ]     VX --- VY[ ]     VY --- VZ[ ]     VZ --- WA[ ]     WA --- WB[ ]     WB --- WC[ ]     WC --- WD[ ]     WD --- WE[ ]     WE --- WF[ ]     WF --- WG[ ]     WG --- WH[ ]     WH --- WI[ ]     WI --- WJ[ ]     WJ --- WK[ ]     WK --- WL[ ]     WL --- WM[ ]     WM --- WN[ ]     WN --- WO[ ]     WO --- WP[ ]     WP --- WQ[ ]     WQ --- WR[ ]     WR --- WS[ ]     WS --- WT[ ]     WT --- WU[ ]     WU --- WV[ ]     WV --- WW[ ]     WW --- WX[ ]     WX --- WY[ ]     WY --- WZ[ ]     WZ --- XA[ ]     XA --- XB[ ]     XB --- XC[ ]     XC --- XD[ ]     XD --- XE[ ]     XE --- XF[ ]     XF --- XG[ ]     XG --- XH[ ]     XH --- XI[ ]     XI --- XJ[ ]     XJ --- XK[ ]     XK --- XL[ ]     XL --- XM[ ]     XM --- XN[ ]     XN --- XO[ ]     XO --- XP[ ]     XP --- XQ[ ]     XQ --- XR[ ]     XR --- XS[ ]     XS --- XT[ ]     XT --- XU[ ]     XU --- XV[ ]     XV --- XW[ ]     XW --- XX[ ]     XX --- XY[ ]     XY --- XZ[ ]     XZ --- YA[ ]     YA --- YB[ ]     YB --- YC[ ]     YC --- YD[ ]     YD --- YE[ ]     YE --- YF[ ]     YF --- YG[ ]     YG --- YH[ ]     YH --- YI[ ]     YI --- YJ[ ]     YJ --- YK[ ]     YK --- YL[ ]     YL --- YM[ ]     YM --- YN[ ]     YN --- YO[ ]     YO --- YP[ ]     YP --- YQ[ ]     YQ --- YR[ ]     YR --- YS[ ]     YS --- YT[ ]     YT --- YU[ ]     YU --- YV[ ]     YV --- YW[ ]     YW --- YX[ ]     YX --- YY[ ]     YY --- YZ[ ]     YZ --- ZA[ ]     ZA --- ZB[ ]     ZB --- ZC[ ]     ZC --- ZD[ ]     ZD --- ZE[ ]     ZE --- ZF[ ]     ZF --- ZG[ ]     ZG --- ZH[ ]     ZH --- ZI[ ]     ZI --- ZJ[ ]     ZJ --- ZK[ ]     ZK --- ZL[ ]     ZL --- ZM[ ]     ZM --- ZN[ ]     ZN --- ZO[ ]     ZO --- ZP[ ]     ZP --- ZQ[ ]     ZQ --- ZR[ ]     ZR --- ZS[ ]     ZS --- ZT[ ]     ZT --- ZU[ ]     ZU --- ZV[ ]     ZV --- ZW[ ]     ZW --- ZX[ ]     ZX --- ZY[ ]     ZY --- ZZ[ ]                 </pre>				
		Interpretation/Discussion: <b>MEDIEVAL OR POST-MEDIEVAL RUBBISH PIT.</b>				
		Finds (tick): None <input type="checkbox"/> Pot <input checked="" type="checkbox"/> Bone <input checked="" type="checkbox"/> Flint <input type="checkbox"/> Stone <input type="checkbox"/> Burnt stone <input type="checkbox"/> Glass <input type="checkbox"/> Metal <input type="checkbox"/> CBM <input checked="" type="checkbox"/> Wood <input type="checkbox"/> Leather <input type="checkbox"/> <b>SAW</b>				
		ΔSmall Finds	Recorder <b>DM</b>			
◇Samples	Date <b>17/11/00</b>					
△Building Materials	Initials					



Oxford Archaeological Unit

SITE <b>OLR 00</b>		CONTEXT RECORD		Context No. <b>1006</b>
Trench		Additional Sheets: <input checked="" type="checkbox"/>		Type <b>FM</b>
Site sub-div <b>SE.</b>		Context Type: Deposit / <del>Cut</del> / <del>Structure</del>		Check Lists:
Structure No.		Overlain by: <b>(994)</b>		DEPOSIT: 1.compaction 2.colour 3.composition 4.inclusions 5.thickness 6.extent 7.comments 8.method & conditions
Plan No.		Abutted by:		
Section No.		Cut by:		CUT: 1.shape in plan 2.base/sides/top profile 3.dimension and depth 4.sketch 5.truncation 6.fill pos 7.other comments
Co-Ordinates		Filled by:		
Level		Same as:		MASONRY: 1.materials 2.size of bricks etc 3.finish of stones 4.coursing/bond 5.form 6.faces 7.bond 8.dimensions as found 9.other comments
Slide No.		Part of:		
Neg No.		Consists of:		Relationships uncertain
Matrix location		Overlies:		
Description (See check lists):		STRATIGRAPHIC MATRIX <pre>                 graph TD                 A[ ] --- B[ ]                 B --- C[994]                 C --- D[ ]                 D --- E[ ]                 E --- F[ ]                 F --- G[1006]                 G --- H[ ]                 H --- I[ ]                 I --- J[1005]                 J --- K[ ]                 </pre> this context is		
Interpretation/Discussion: <b>FM OF MED./POST-MED. RUBBISH PIT BEHIND THE LEVEL OF SOUTH CHURCH YARD.</b>				
Finds (tick): None <input type="checkbox"/> Pot <input checked="" type="checkbox"/> Bone <input checked="" type="checkbox"/> Flint <input type="checkbox"/> Stone <input type="checkbox"/> Burnt stone <input type="checkbox"/> Glass <input type="checkbox"/> Metal <input type="checkbox"/> CBM <input checked="" type="checkbox"/> Wood <input type="checkbox"/> Leather <input type="checkbox"/> <b>SHUEN</b>				
ΔSmall Finds			Recorder <b>DM</b>	
◇Samples			Date <b>07/11/00</b>	
ΔBuilding Materials			Initials	

dh

SITE OLR 00	COFFIN RECORD SHEET	CONTEXT NO. 1007
Trench:	Additional sheets: <u>1/23 x 1</u>	Treatment: <u>BONES LIFTED</u>
Site sub-div: S.C.	Grave fills	
Plan no: 6	Grave cut:	Finds None
Section no:	Skeleton:	Breastplate Grip
Co-ordinates:	Matrix location: <u>(1007) o/l (1008)</u>	Hinge Bracket
Levels	Preservation:	Fixing nails Shroud pins
Slide No.	Neg No:	Fabric Other finds

Description Pl-COFFIN. E-W ORIENTATED. FEET END OF THE COFFIN HAS BEEN BADLY DAMAGED - NOT SUBJECT TO MEASUREMENT. SOLDERED BREASTPLATE BADLY CORRODED AND NOT REMOVABLE.

Discussion ADULT BURIAL. SKULL DISINTEGRATED, BUT HAIR PRESENT. INNER WOOD. C/A NOT STOWWORK.

Shape, dimensions and distinguishing characteristics

LID

HEAD

BASE

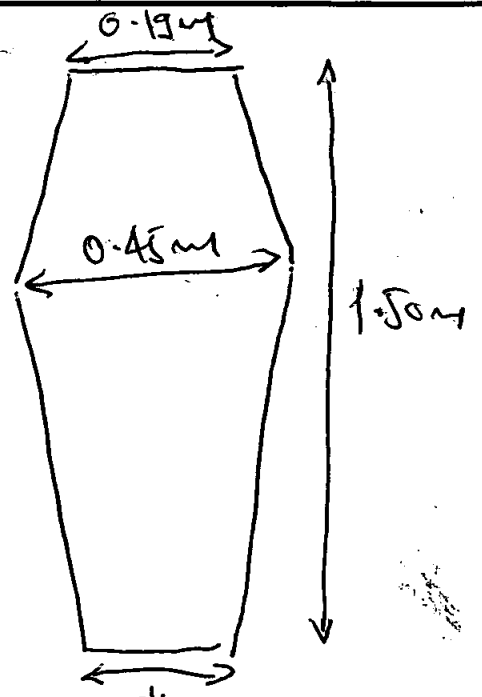

~~...~~  
DID NOT SURVIVE

Recorder: DM	Date: 17/11/00	Initials:
-----------------	-------------------	-----------

# Coffin Recording Sheet

Site Code

Context

**Outer Coffin**

Sample Ret.

OK100

1007

Recording Date ..... 6/12/00 .....

Associated Numbers .....

Condition .....

Dep. Plate

Legible

Inscription

Fabric lead  ormolou  brass  tin plated pewter  gilt tin   
 iron  silvered tin  enamelled  other ..... Sample Ret.

**Shape of dep. plate**

square  rectangle  shield  tapered  lozenge   
 cartouche  oval  other .....

**Upholstery**

colour ..... shoddy  velvet  other ..... Sample Ret.

**Construction**

butt joint  mitred  pitched  other .....

**Grip plate**  Fabric = ormolou  brass  tin plated pewter  gilt tin   
 iron  silvered tin  enamelled  other ..... Sample Ret.

**Grip**  Fabric = ormolou  brass  iron  Sample Ret.

**Design** swag of rose  horseshoe  cherub's head  plain   
 other .....

**Grip bolts**  **Corner bolts**  **Type =** gilt brass  brass  iron   
 other ..... Sample Ret.

**Lid motifs**  other ..... Sample Ret.

**Escutcheons**  other ..... Sample Ret.

**Upholstery** <sup>stud</sup> nails  brass  gilt brass  silvered brass  iron  enamelled   
 other ..... *x 1 stud.* ..... Sample Ret.

**Fixings**  panel nails  screws  hinges  lace  Sample Ret.

**Timber type** ..... Sample Ret.

**Interpretation / Comments**

.....  
 .....

SITE		COFFIN RECORD SHEET		CONTEXT NO.	
OLR 00				1008	
Trench:		Additional sheets:		Treatment: DNA/BONES	
Site sub-div:	SE.	Grave fills:			
Plan no:	6	Grave cut:		Finds None	
Section no:		Skeleton:		Breastplate Grip	
Co-ordinates:		Matrix location:	(1008) J/L (1007)	Hinge Bracket	
Levels:		Preservation:		Fixing nails Shroud pins	
Slide No.		Neg No:		Fabric Other finds	

**Description** E-W Pb-coffin, about burial, inner wood, w/ many snowflake.

**Discussion**

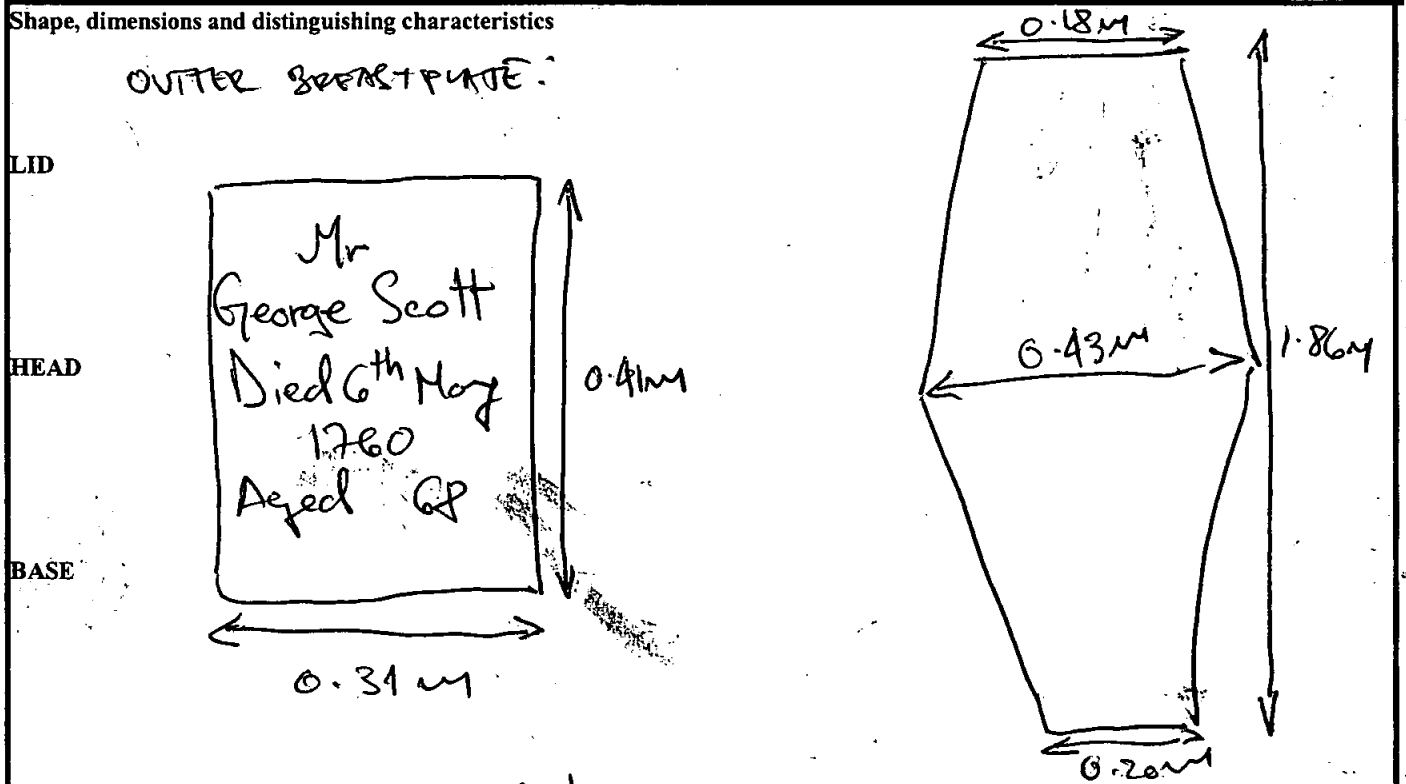

**Recorder:** DM      **Date:** 17/11/60      **Initials:**

# Coffin Recording Sheet

Site Code

Context

**Outer Coffin**

Sample Ret.

OLR00

1008

Recording Date ..... 20/2/01 .....

Associated Numbers .....

Condition ..... 2 .....

Dep. Plate

Legible  LSH

There are 277  
1008 sheets

Inscription " Mrs / Cath<sup>e</sup> Ne ??? / Died 12<sup>th</sup> Oct<sup>r</sup> / 1780? / Aged 65  
Some on  
65  
years"

Fabric lead  ormolou  brass  tin plated pewter  gilt tin   
iron  silvered tin  enamelled  other ..... Sample Ret.

**Shape of dep. plate**

square  rectangle  shield  tapered  lozenge   
cartouche  oval  other .....

**Upholstery**

colour ..... shoddy  velvet  other ..... Sample Ret.

**Construction**

butt joint  mitred  pitched  other .....

Grip plate  Fabric = ormolou  brass  tin plated pewter  gilt tin   
iron  silvered tin  enamelled  other ..... Sample Ret.

Grip  Fabric = ormolou  brass  iron  Sample Ret.

Design swag of rose  horseshoe  cherub's head  plain

other .....

Grip bolts  Corner bolts  Type = gilt brass  brass  iron

other ..... Sample Ret.

Lid motifs  other ..... Sample Ret.

Escutcheons  other ..... Sample Ret.

Upholstery nails  brass  gilt brass  silvered brass  iron  enamelled

other ..... Sample Ret.

Fixings  panel nails  screws  hinges  lace  Sample Ret.

Timber type ..... Sample Ret.

**Interpretation / Comments**

.....  
.....

Site Code

Context

**Outer Coffin**

Sample Ret.

042006

1008

Recording Date ..... 20/2/01 .....

Associated Numbers .....

Condition ..... 3 .....

Dep. Plate

Legible

Inscription *MR/George Scott/ Died 16<sup>th</sup> Aug<sup>st</sup>/1766/ Aged 58*

*new type see sheet.*

Fabric lead  ormolou  brass  tin plated pewter  gilt tin   
 iron  silvered tin  enamelled  other ..... *traces of gilding* Sample Ret.

**Shape of dep. plate**

square  rectangle  shield  tapered  lozenge   
 cartouche  oval  other .....

**Upholstery**

colour ..... shoddy  velvet  other ..... Sample Ret.

**Construction**

butt joint  mitred  pitched  other .....

**Grip plate**  Fabric = ormolou  brass  tin plated pewter  gilt tin   
 iron  silvered tin  enamelled  other ..... Sample Ret.

**Grip**  Fabric = ormolou  brass  iron  Sample Ret.

**Design** swag of rose  horseshoe  cherub's head  plain

other .....

**Grip bolts**  **Corner bolts**  **Type =** gilt brass  brass  iron

other ..... Sample Ret.

**Lid motifs**  other ..... Sample Ret.

**Escutcheons**  other ..... Sample Ret.

**Upholstery nails**  brass  gilt brass  silvered brass  iron  enamelled

other ..... Sample Ret.

**Fixings**  panel nails  screws  hinges  lace  Sample Ret.

**Timber type** ..... Sample Ret.

**Interpretation / Comments**

.....  
 .....

SITE		COFFIN RECORD SHEET		CONTEXT NO.	
OUR 00				1009	
Trench:		Additional sheets:		Treatment:	
Site sub-div: S.C.		Grave fills		Bones / DNA	
Plan no: 6		Grave cut:		Finds	
Section no:		Skeleton:		None	
Co-ordinates:		Matrix location: 1009		Breastplate ✓	
Levels		Preservation: Good		Grip	
Slide No.		Neg No:		Hinge	
				Bracket	
				Fixing nails	
				Shroud pins	
				Fabric	
				Other finds	

**Description** E-W Pb-coffin. ABOUT BURIAL. ~~OUTER BREASTPLATE PRESENT~~  
~~OUTER BREASTPLATE PRESENT~~ OUTER BREASTPLATE PRESENT.  
 COFFIN HEAVILY DAMAGED AT TOP - LID HAS SUNK ALL THE WAY  
 INTO THE COFFIN. NO SOLDERED COFFIN-PLATE, BUT COFFIN LID  
**Discussion** ITSELF ENGRAVED.  
 INNER WOOD PRESENT, NO EVIDENCE OF STUD WORK.

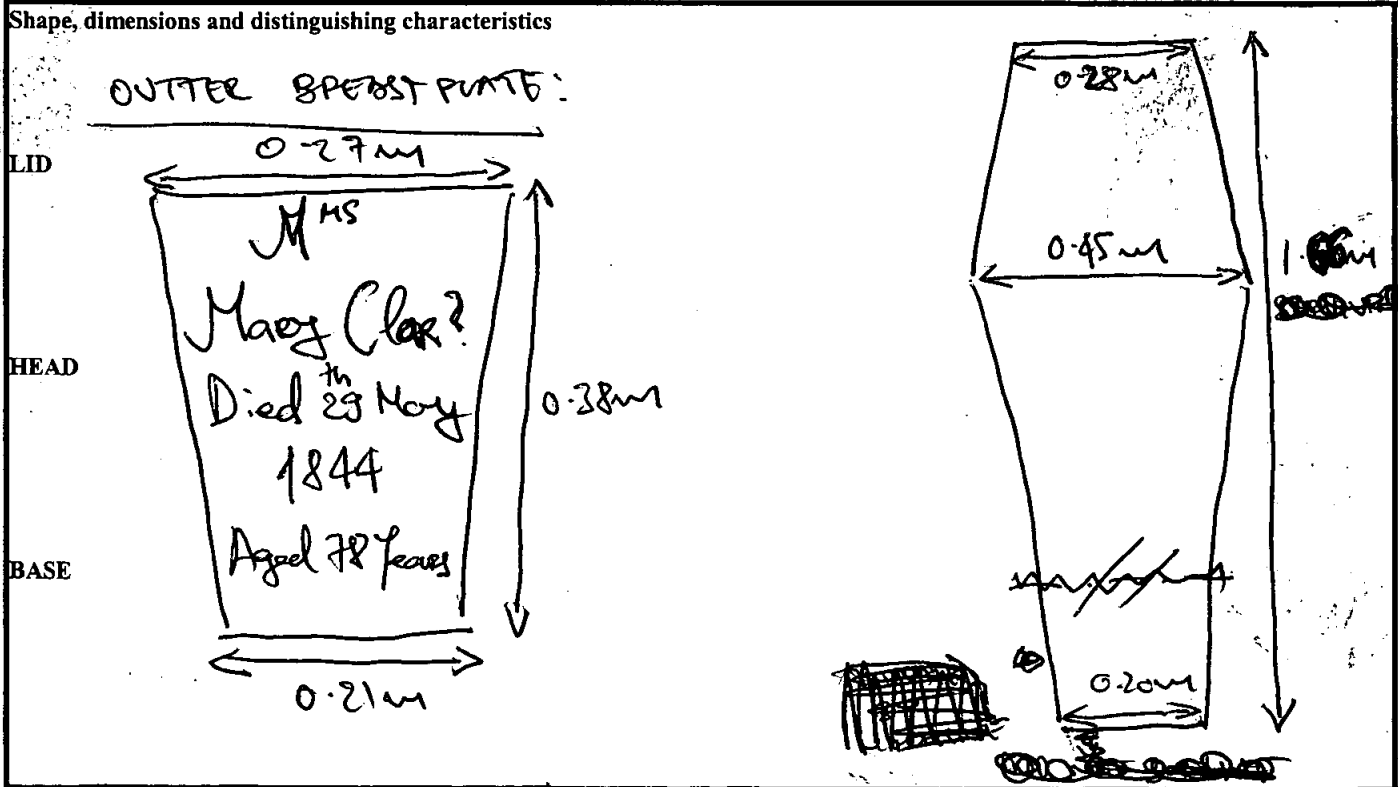

Recorder: JM	Date: 13/11/00	Initials:
--------------	----------------	-----------

Site Code

Context

**Outer Coffin**

Sample Ret.

06200

1009

Recording Date ..... 15/2/01 .....

Associated Numbers .....

Condition ..... 3 .....

Dep. Plate

Legible

Inscription "Mao/Mary Clark/Died 29<sup>th</sup> May/1844/Aged 78 Yrs"

same as 845 inc. borders

Fabric lead  ormolou  brass  tin plated pewter  gilt tin   
 iron  silvered tin  enamelled  other ..... Sample Ret.

black polished.

**Shape of dep. plate**

square  rectangle  shield  tapered  lozenge   
 cartouche  oval  other .....

**Upholstery**

colour ..... shoddy  velvet  other ..... Sample Ret.

**Construction**

butt joint  mitred  pitched  other .....

**Grip plate**  Fabric = ormolou  brass  tin plated pewter  gilt tin   
 iron  silvered tin  enamelled  other ..... Sample Ret.

**Grip**  Fabric = ormolou  brass  iron  Sample Ret.

**Design** swag of rose  horseshoe  cherub's head  plain   
 other .....

**Grip bolts**  **Corner bolts**  Type = gilt brass  brass  iron

other ..... Sample Ret.

**Lid motifs**  other ..... Sample Ret.

**Escutcheons**  other ..... Sample Ret.

**Upholstery nails**  brass  gilt brass  silvered brass  iron  enamelled   
 other ..... Sample Ret.

**Fixings**  panel nails  screws  hinges  lace  Sample Ret.

**Timber type** ..... Sample Ret.

**Interpretation / Comments**

.....  
 .....



SITE		COFFIN RECORD SHEET		CONTEXT NO.	
OLR 00				1010	
Trench:	Additional sheets:		Treatment:		
Site sub-div: S.C.	Grave fills		BURY LATER		
Plan no: 6	Grave cut:		Finds		
Section no:	Skeleton:		None		
Co-ordinates:	Matrix location: 1010		Breastplate		
Levels	Preservation:		Grip		
Slide No:	Neg No:		Hinge		
			Bracket		
			Fixing nails		
			Shroud pins		
			Fabric		
			Other finds		

**Description** PB-COFFIN. E-W. ADULT BURIAL. INNER WOOD.  
 • COFFIN TRUNCATED FROM PELVIS AREA UPWARDS.  
 BURY CORRODED AND DAMAGED.

**Discussion**

**Shape, dimensions and distinguishing characteristics**

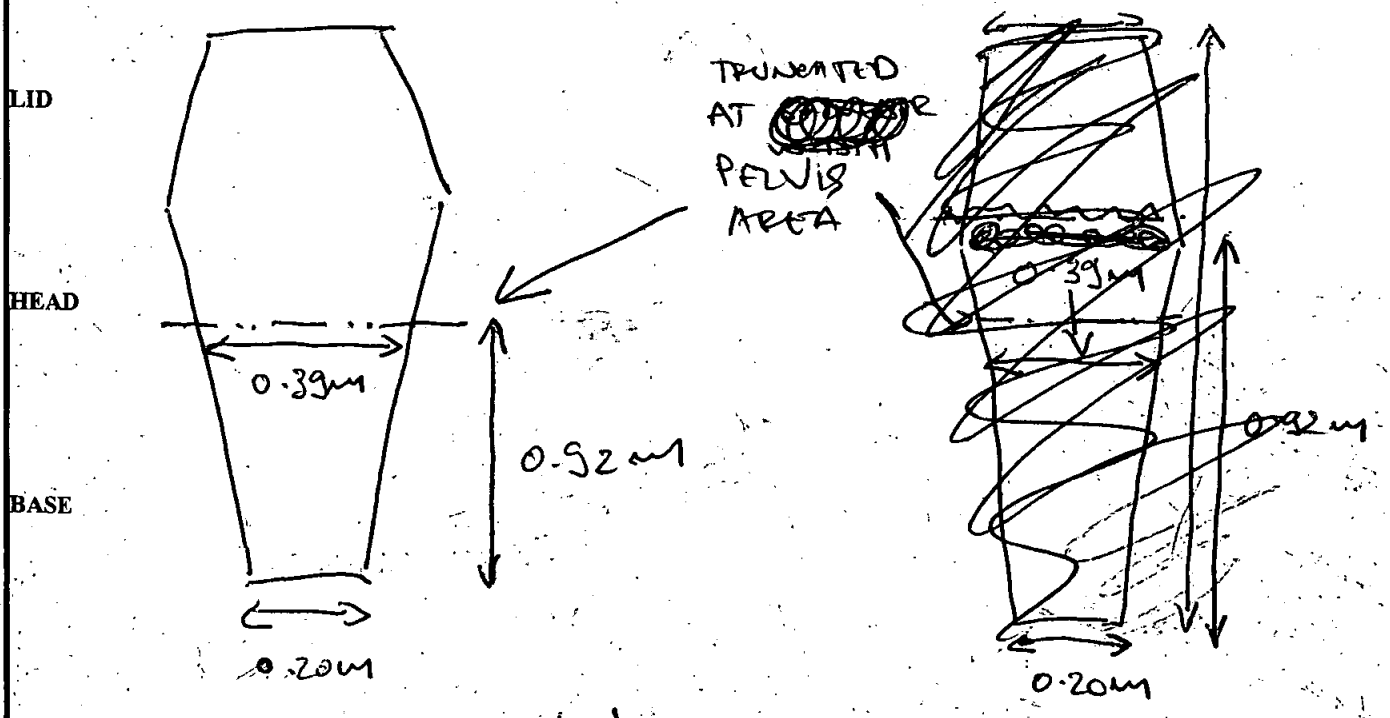

Recorder: DM Date: 20/11/00 Initials:

SITE OLR 00	COFFIN RECORD SHEET	CONTEXT NO. 1011
Trench:	Additional sheets:	Treatment: BONES LIFTED
Site sub-div: SE.	Grave fills:	
Plan no: 6	Grave cut:	Finds None
Section no:	Skeleton:	Breastplate Grip
Co-ordinates:	Matrix location:  (1011) J/K (1008)	Hinge Bracket
Levels:	Preservation: POOR	Fixing nails Shroud pins
Slide No.:	Neg No.:	Fabric Other finds
<p>Description E-W Pb-COFFIN - ADULT. COFFIN SURVIVING PART AT HEAD END. COMPLETELY DESTROYED OTHERWISE - TRUNCATED FROM SHOULDER WIDTH DOWNWARDS, PROBABLY BY THE SAME TRUNCATION CUT TRUNCATING (1010) FROM PELVIS UPWARDS. NO MEASUREMENTS OF THE COFFIN OBTAINABLE.</p> <p>Discussion</p>		
<p>Shape, dimensions and distinguishing characteristics</p> <p>Extra bones: Right femur with Paget's disease, same individual as recorded on "extra bones" 1013. = charnal bones</p> <p>LID</p> <p>HEAD</p> <p>BASE</p>		
Recorder: DM	Date: 20/11/00	Initials:

SITE OLR 00	COFFIN RECORD SHEET	CONTEXT NO. 1012
Trench:	Additional sheets: YES x1	Treatment: BONES LIFTED
Site sub-div: S.C.	Grave fills	
Plan no: 6	Grave cut:	Finds None
Section no:	Skeleton:	Breastplate Grip ✓
Co-ordinates:	Matrix location: (1012) w/L (1011)	Hinge Bracket
Levels	Preservation: FAIRLY GOOD	Fixing nails Shroud pins
Slide No.	Neg No:	Fabric Other finds

Description E-W ADULT BURIAL. WOODEN COFFIN  
W-ANEY STUWORK. FE GRIPS.

Discussion

Shape, dimensions and distinguishing characteristics

LID

Extra bones:  
L. Humerus  
R. Ulna  
R 2nd MC  
R 1st MC  
Distal 1/2 L Fibula

Male?  
Adult

HEAD

Spine, segments T6-L6 + Sacrum - female?  
Adult

BASE

Recorder: DM	Date: 20/11/00	Initials:
-----------------	-------------------	-----------

# Coffin Recording Sheet

**Outer Coffin**

Sample Ret.

Site Code

Context

Recording Date ..... 1912.

OL600

1012

Associated Numbers .....

Condition .....

Dep. Plate

Legible

Inscription

Fabric lead  ormolou  brass  tin plated pewter  gilt tin   
 iron  silvered tin  enamelled  other ..... Sample Ret.

**Shape of dep. plate**

square  rectangle  shield  tapered  lozenge   
 cartouche  oval  other .....

**Upholstery**

colour ..... shoddy  velvet  other ..... Sample Ret.

**Construction**

butt joint  mitred  pitched  other .....

**Grip plate**

Fabric = ormolou  brass  tin plated pewter  gilt tin   
 iron  silvered tin  enamelled  other ..... Sample Ret.   
*Flags on rev of grip-wood.*

**Grip**

Fabric = ormolou  brass  iron  x2 Sample Ret.

**Design**

swag of rose  horseshoe  cherub's head  (3b) plain

other .....

**Grip bolts**

**Corner bolts**  Type = gilt brass  brass  iron

other ..... Sample Ret.

**Lid motifs**

other ..... Sample Ret.

**Escutcheons**

other ..... Sample Ret.

**Upholstery**

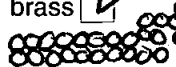
*studs*  
 brass  gilt brass  silvered brass  iron  enamelled   
 other ..... *1 x piece*  *= 24 studs in total.* Sample Ret.

**Fixings**

panel nails  screws  hinges  lace  Sample Ret.

**Timber type** .....

Sample Ret.

**Interpretation / Comments**

.....  
 .....

SITE	COFFIN RECORD SHEET	CONTEXT NO.
OR 00		1013
Trench:	Additional sheets:	Treatment:
Site sub-div: S.E.	Grave fills	BONES LIFTED
Plan no: 6	Grave cut:	Finds
Section no:	Skeleton:	None
Co-ordinates:	Matrix location:	Breastplate
Levels:	Preservation:	Grip
Slide No.	Neg No:	Hinge
		Bracket
		Fixing nails
		Shroud pins
		Fabric
		Other finds ✓*

**Description** E-W ADULT BURIAL, WOODEN COFFIN.  
 CW MUDY S+D WORK.

**Discussion**

\* bone handle prob. from cutlery of some kind, polished. In w/ skelly.

**Shape, dimensions and distinguishing characteristics**

**LID**

Extra bones!

L Femur	} Same individual Adult Male?? Shafts very thickened, cortical bone disorganised, Medullar cavity narrowed <u>Paget's disease</u> = Charnal remains
L Tibia	
L Talus	
R 1st Mt	

**HEAD**

L Tibia	} Same individual Adult Size wise possibly ♀ 1012??
L calcaneus	
L Talus	
L 1st Mt	
L+R 5th Mt	

**BASE**

R 2nd Mt	
L+R 1st Mc	
R 5th Mc	
L 2nd Mc	

Recorder: DM	Date: 20/11/00	Initials:
--------------	----------------	-----------

alb

SITE		COFFIN RECORD SHEET		CONTEXT NO.	
OLR 00				1014	
Trench:		Additional sheets: 4/2 x 1.		Treatment: BONES LIFTED	
Site sub-div: S.C.		Grave fills			
Plan no: G		Grave cut:		Finds None	
Section no:		Skeleton:		Breastplate Grip ✓	
Co-ordinates:		Matrix location: (1014) J/L (1009)		Hinge Bracket	
Levels		Preservation:		Fixing nails Shroud pins	
Slide No.		Neg No:		Fabric Other finds	
<p><b>Description</b> E-W ADULT BURIAL. WOODEN COFFIN.            VERY CLOSE TO (1015), SHOULD BE LOOKED AT TOGETHER WITH (1015) DUE TO POSSIBLE MIXING.</p> <p><b>Discussion</b>            Extra bones; R+L Calcaneus, R+L Talus, R+L Navicular, R+L 1st cuniform, R+L 3rd cuniform, R+L 1st Mt, R+L 2nd Mt, L 3rd Mt, R+L 4th Mt, R+L 5th Mt, Left clavicle</p> <p><b>Shape, dimensions and distinguishing characteristics</b> left scapula.            All part of same adult individual (size wise). Possibly 1015</p>					
LID					
HEAD					
BASE					
Recorder: DM		Date: 20/11/00		Initials:	

# Coffin Recording Sheet

Site Code

Context

**Outer Coffin**

Sample Ret.

*CH200*

*1014*

Recording Date ..... *12/12/00* .....

Associated Numbers .....

Condition .....

Dep. Plate

Legible

Inscription

**Fabric lead**  ormolou  brass  tin plated pewter  gilt tin   
 iron  silvered tin  enamelled  other ..... Sample Ret.

**Shape of dep. plate**

square  rectangle  shield  tapered  lozenge   
 cartouche  oval  other .....

**Upholstery**

colour ..... shoddy  velvet  other ..... Sample Ret.

**Construction**

butt joint  mitred  pitched  other .....

**Grip plate**

Fabric = ormolou  brass  tin plated pewter  gilt tin   
*freeson rev. of grip-urid.*  
 iron  silvered tin  enamelled  other ..... Sample Ret.

**Grip**

Fabric = ormolou  brass  iron  *X1* Sample Ret.

**Design**

swag of rose  horseshoe  cherub's head  *①* plain

other .....

**Grip bolts**

**Corner bolts**  Type = gilt brass  brass  iron

other ..... Sample Ret.

**Lid motifs**

other ..... Sample Ret.

**Escutcheons**

other ..... Sample Ret.

**Upholstery nails**

brass  gilt brass  silvered brass  iron  enamelled

other ..... Sample Ret.

**Fixings**

panel nails  screws  hinges  lace  Sample Ret.

**Timber type**

..... Sample Ret.

**Interpretation / Comments**

.....  
 .....

SITE		COFFIN RECORD SHEET		CONTEXT NO.	
OLR 00				1015	
Trench:		Additional sheets: YES X1		Treatment:	
Site sub-div: S.C.		Grave fills		BONES LIFTED	
Plan no: 6		Grave cut:		Finds	
Section no:		Skeleton:		None	
Co-ordinates:		Matrix location:		Breastplate	
Levels		Preservation:		Grip ✓	
Slide No.		Neg No:		Hinge	
				Bracket	
				Fixing nails	
				Shroud pins	
				Fabric	
				Other finds	

**Description** E-W ADULT BURIAL. WOODEN COFFIN, BURIAL VERY CLOSE TO (1014) AND POSSIBLE MIXING OF BONES SHOULD NOT BE OVERLOOKED.

**Discussion** UPPER BURIAL (1014) SINKING INTO LOWER (1015).

Shape, dimensions and distinguishing characteristics

LID

HEAD

BASE

Recorder: DM	Date: 20/11/00	Initials:
--------------	----------------	-----------



# Coffin Recording Sheet

Site Code

Context

Outer Coffin

Sample Ret.

OH200

1015

Recording Date ..... 14/12/00

Associated Numbers .....

Condition .....

Dep. Plate

Legible

Inscription

Fabric lead  ormolou  brass  tin plated pewter  gilt tin   
iron  silvered tin  enamelled  other ..... Sample Ret.

Shape of dep. plate

square  rectangle  shield  tapered  lozenge   
cartouche  oval  other .....

Upholstery

colour ..... shoddy  velvet  other ..... Sample Ret.

Construction

butt joint  mitred  pitched  other .....

Grip plate

Fabric = ormolou  brass  tin plated pewter  gilt tin   
iron  silvered tin  enamelled  other ..... Sample Ret.   
*1 x 3 (fragmented)*

Grip

Fabric = ormolou  brass  iron  Sample Ret.   
*1 x 4*

Design

swag of rose  horseshoe  cherub's head  plain

other .....

Grip bolts

Corner bolts  Type = gilt brass  brass  iron

other ..... Sample Ret.

Lid motifs

other ..... Sample Ret.

Escutcheons

other ..... Sample Ret.

Upholstery

*studs*  
nails  brass  gilt brass  silvered brass  iron  enamelled   
other ..... *oo* Sample Ret.

Fixings

panel nails  screws  hinges  lace  Sample Ret.

Timber type

Sample Ret.

Interpretation / Comments

.....  
.....

SITE		COFFIN RECORD SHEET		CONTEXT NO.	
OUR 00				1016	
Trench:		Additional sheets: YES X1		Treatment: BONES LIFTED	
Site sub-div: S.C.		Grave fills			
Plan no: 6		Grave cut:		Finds None	
Section no:		Skeleton:		Breastplate Grip ✓	
Co-ordinates:		Matrix location: 1016 o/L 1017		Hinge Bracket	
Levels		Preservation:		Fixing nails Shroud pins	
Slide No.		Neg No:		Fabric Other finds	
<p>Description E-W BURIAL, WOODEN COFFIN, FE STUDWORK + FE GRIPS. BURIAL PARTIALLY TRUNCATED FROM PELVIS UPWARDS. ALSO, POSSIBILITY OF BONES SINKING INTO THE SUBSTANTIAL HOLLOW OF THE GRAVE SLIGHTLY BELOW AND NORTH OF 1016</p> <p>Discussion</p>					
<p>Shape, dimensions and distinguishing characteristics</p> <p>LID</p> <p>HEAD</p> <p>BASE</p> <p>Extra bones:  R. Os coxa  R Fibula  R Talus  " Calcaneus  " Cuboid  " Navicular  " Lateral cuneiform  L+R 1st ME's  R 2nd &amp; 4th ME</p> <p>All adult  - large &amp; robust  Male?  Part of 1017?</p>					
Recorder: DM		Date: 21/11/00		Initials:	

# Coffin Recording Sheet

Site Code

Context

**Outer Coffin**

Sample Ret.

OH100

1016

Recording Date ..... 21/12/00 .....

Associated Numbers .....

Condition .....

Dep. Plate

Legible

Inscription

**Fabric** lead  ormolou  brass  tin plated pewter  gilt tin   
 iron  silvered tin  enamelled  other ..... Sample Ret.

**Shape of dep. plate**

square  rectangle  shield  tapered  lozenge   
 cartouche  oval  other .....

**Upholstery**

colour ..... shoddy  velvet  other ..... Sample Ret.

**Construction**

butt joint  mitred  pitched  other .....

**Grip plate**  Fabric = ormolou  brass  tin plated pewter  gilt tin   
 iron  silvered tin  enamelled  other ..... Sample Ret.

*keys on rev of grip-wood.*

**Grip**  Fabric = ormolou  brass  iron  x3 Sample Ret.

**Design** swag of rose  horseshoe  cherub's head  ①'s plain   
 other .....

**Grip bolts**  **Corner bolts**  **Type =** gilt brass  brass  iron

other ..... Sample Ret.

**Lid motifs**  other ..... Sample Ret.

**Escutcheons**  other ..... Sample Ret.

**Upholstery nails**  brass  gilt brass  silvered brass  iron  enamelled

other ..... Sample Ret.

**Fixings**  panel nails  screws  hinges  lace  Sample Ret.

**Timber type** ..... Sample Ret.

**Interpretation / Comments**

.....  
 .....

SITE <b>OLR 00</b>		COFFIN RECORD SHEET	CONTEXT NO. <b>1017</b>
Trench:	Additional sheets: <b>YES x 1.</b>		Treatment:
Site sub-div: <b>S.E.</b>	Grave fills		<b>BONES LIFTED</b>
Plan no: <b>6</b>	Grave cut:		Finds
Section no:	Skeleton:		None
Co-ordinates:	Matrix location: <b>(1017) O/L (1016)</b>		Breastplate
Levels	Preservation:		Grip
Slide No.	Neg No:		Hinge
Description			Bracket
Discussion			Fixing nails
Shape, dimensions and distinguishing characteristics			Shroud pins
LID			Fabric
HEAD			Other finds
BASE			
Recorder: <b>DM</b>	Date: <b>21/17/00</b>	Initials:	

**DESCRIPTION**  
 F-W ADULT BURIAL. HEAVILY TRUNCATED, ONLY ONE ARTICULATED LEG PRESENT (LEFT LEG)

Site Code

Context

**Outer Coffin**

Sample Ret.

Ch200

1017

Recording Date ..... 21/12/00 .....

Associated Numbers .....

Condition .....

Dep. Plate

Legible

Inscription

Fabric lead       ormolou       brass       tin plated pewter       gilt tin   
 iron       silvered tin       enamelled       other .....      Sample Ret.

**Shape of dep. plate**

square       rectangle       shield       tapered       lozenge   
 cartouche       oval       other .....

**Upholstery**

colour .....      shoddy       velvet       other .....      Sample Ret.

**Construction**

butt joint       mitred       pitched       other .....

**Grip plate**       Fabric = ormolou       brass       tin plated pewter       gilt tin   
 iron       silvered tin       enamelled       other .....      Sample Ret.

**Grip**       Fabric = ormolou       brass       iron       Sample Ret.

**Design**      swag of rose       horseshoe       cherub's head       plain   
 other .....

**Grip bolts**       **Corner bolts**       Type =      gilt brass       brass       iron   
 other .....      Sample Ret.

**Lid motifs**       other .....      Sample Ret.

**Escutcheons**       other 1 x Fe (black enamelled) Feag - prob. escutcheon.      Sample Ret.

**Upholstery nails**       brass       gilt brass       silvered brass       iron       enamelled   
 other .....      Sample Ret.

**Fixings**       panel nails       screws       hinges       lace       Sample Ret.

**Timber type** .....      Sample Ret.

**Interpretation / Comments**

.....  
 .....

SITE		COFFIN RECORD SHEET		CONTEXT NO.	
OUR 00				1018	
Trench:		Additional sheets: YES x1		Treatment:	
Site sub-div:		Grave fills		BONES LIFTED	
Plan no:		Grave cut:		Finds	
Section no:		Skeleton:		None	
Co-ordinates:		Matrix location:		Breastplate	
Levels		Preservation:		Grip <input checked="" type="checkbox"/>	
Slide No.		Neg No:		Hinge	
				Bracket	
				Fixing nails	
				Shroud pins	
				Fabric	
				Other finds	

Description E-W ADULT BURIAL POOR PRESERVATION, TERMINATED  
 LIKE OTHER BURIALS IN THIS AREA.  
 NO ~~VERTEBRAE~~ VERTEBRAE OR SKULL PRESENT.

Discussion

Shape, dimensions and distinguishing characteristics

LID

HEAD

BASE

Recorder: DM	Date: 21/11/00	Initials:
--------------	----------------	-----------

# Coffin Recording Sheet

Site Code

Context

**Outer Coffin**

Sample Ret.

*2200*

*1018*

Recording Date ..... *13/2/01* .....

Associated Numbers .....

Condition .....

Dep. Plate

Legible

Inscription

Fabric lead  ormolou  brass  tin plated pewter  gilt tin   
 iron  silvered tin  enamelled  other ..... Sample Ret.

**Shape of dep. plate**

square  rectangle  shield  tapered  lozenge   
 cartouche  oval  other .....

**Upholstery**

colour ..... shoddy  velvet  other ..... Sample Ret.

**Construction**

butt joint  mitred  pitched  other .....

**Grip plate**

Fabric = ormolou  brass  tin plated pewter  gilt tin   
*leags on rev of grip-unid.*  
 iron  silvered tin  enamelled  other ..... Sample Ret.

**Grip**

Fabric = ormolou  brass  iron  *x2* Sample Ret.

**Design**

swag of rose  horseshoe  cherub's head  *Conc 4's* plain

other .....

**Grip bolts**

**Corner bolts**  Type = gilt brass  brass  iron

other ..... Sample Ret.

**Lid motifs**

other ..... Sample Ret.

**Escutcheons**

other ..... Sample Ret.

**Upholstery nails**

brass  gilt brass  silvered brass  iron  enamelled

other ..... Sample Ret.

**Fixings**

panel nails  screws  hinges  lace  Sample Ret.

**Timber type**

..... Sample Ret.

**Interpretation / Comments**

.....  
 .....

SITE <u>OLR 06</u>		COFFIN RECORD SHEET	CONTEXT NO. <u>1019</u>
Trench:	Additional sheets: <u>YES x 1.</u>	Treatment: <u>BONES LIFTED</u>	
Site sub-div: <u>S.C.</u>	Grave fills		
Plan no: <u>6</u>	Grave cut:	Finds None	
Section no:	Skeleton:	Breastplate Grip <input checked="" type="checkbox"/>	
Co-ordinates:	Matrix location: <u>(1019) U/L (1018)</u>	Hinge Bracket	
Levels	Preservation: <u>Good</u>	Fixing nails Shroud pins	
Slide No.	Neg No:	Fabric Other finds	
<p>Description <u>E-W JUVENILE BURIAL. INNER WOOD. GRIPS PRESENT FEET MISSING - POSSIBLY SUNK INTO CAVITY OF BURIAL BELOW.</u></p> <p>Discussion</p>			
<p>Shape, dimensions and distinguishing characteristics</p> <p>LID</p> <p>HEAD</p> <p>BASE</p>			
Recorder: <u>DM</u>	Date: <u>21/11/00</u>	Initials:	



# Coffin Recording Sheet

Site Code

Context

**Outer Coffin**

Sample Ret.

0200

1019

Recording Date ..... 22/12/00 .....

Associated Numbers .....

Condition .....

Dep. Plate

Legible

Inscription

Fabric lead  ormolou  brass  tin plated pewter  gilt tin   
 iron  silvered tin  enamelled  other ..... Sample Ret.

**Shape of dep. plate**

square  rectangle  shield  tapered  lozenge   
 cartouche  oval  other .....

**Upholstery**

colour ..... shoddy  velvet  other ..... Sample Ret.

**Construction**

butt joint  mitred  pitched  other .....

**Grip plate**

Fabric = ormolou  brass  tin plated pewter  gilt tin   
*Flags on REV of grip - unid.*  
 iron  silvered tin  enamelled  other ..... Sample Ret.

**Grip**

Fabric = ormolou  brass  iron  *x2*. Sample Ret.

**Design**

swag of rose  horseshoe  cherub's head  plain

other ..... *↔ 0.09 ↓ 0.04* *intent ①'s* .....

**Grip bolts**

**Corner bolts**  Type = gilt brass  brass  iron

other ..... Sample Ret.

**Lid motifs**

other ..... Sample Ret.

**Escutcheons**

other ..... Sample Ret.

**Upholstery nails**

brass  gilt brass  silvered brass  iron  enamelled

other ..... Sample Ret.

**Fixings**

panel nails  screws  hinges  lace  Sample Ret.

**Timber type**

..... Sample Ret.

**Interpretation / Comments**

.....  
 .....

SITE <u>OUR 00</u>		COFFIN RECORD SHEET		CONTEXT NO. <u>1020</u>	
Trench:		Additional sheets: <u>YESX1.</u>		Treatment:	
Site sub-div: <u>S.R.</u>		Grave fills		<u>BONES LIFTED</u>	
Plan no: <u>6</u>		Grave cut:		Finds	
Section no:		Skeleton:		None	
Co-ordinates:		Matrix location: <u>1020</u> v/c <u>1018</u>		Breastplate	
Levels		Preservation:		Grip <input checked="" type="checkbox"/>	
Slide No.		Neg No:		Hinge	
Description		<u>E-W INFANT BURIAL, Fe GRIPS.</u>		Bracket	
Discussion				Fixing nails	
Shape, dimensions and distinguishing characteristics				Shroud pins	
LID				Fabric	
HEAD				Other finds	
BASE					
Recorder: <u>DM</u>		Date: <u>21/11/00</u>		Initials:	

Site Code

Context

**Outer Coffin**

Sample Ret.

OR00

1020

Recording Date ..... 29/12/00 .....

Associated Numbers .....

Condition .....

Dep. Plate

Legible

Inscription

Fabric lead  ormolou  brass  tin plated pewter  gilt tin   
 iron  silvered tin  enamelled  other ..... Sample Ret.

**Shape of dep. plate**

square  rectangle  shield  tapered  lozenge   
 cartouche  oval  other .....

**Upholstery**

colour ..... shoddy  velvet  other ..... Sample Ret.

**Construction**

butt joint  mitred  pitched  other .....

Grip plate  Fabric = ormolou  brass  tin plated pewter  gilt tin   
 iron  silvered tin  enamelled  other ..... Sample Ret.

Grip  Fabric = ormolou  brass  iron  *x1 infant.* Sample Ret.

Design swag of rose  horseshoe  cherub's head  plain   
 other ..... *↔ 0.09 ↗ 0.05*

Grip bolts  Corner bolts  Type = gilt brass  brass  iron   
 other ..... Sample Ret.

Lid motifs  other ..... Sample Ret.

Escutcheons  other ..... Sample Ret.

Upholstery nails  brass  gilt brass  silvered brass  iron  enamelled   
 other ..... Sample Ret.

Fixings  panel nails  screws  hinges  lace  Sample Ret.

Timber type ..... Sample Ret.

**Interpretation / Comments**

.....  
 .....

SITE		COFFIN RECORD SHEET		CONTEXT NO.	
OUR 00				1021	
Trench:		Additional sheets:		Treatment:	
Site sub-div: S.C.		Grave fills		BONES LIFTED	
Plan no: 6		Grave cut:		Finds	
Section no:		Skeleton:		None	
Co-ordinates:		Matrix location: with 1297 (1021) U/L (1019)		Breastplate	
Levels		Preservation:		Grip	
Slide No.		Neg No:		Hinge	
Description		E-W ADULT BURIAL. BURIAL HAS BEEN MACHINED OUT AS TOO CLOSE TO HIGH INSURE SECTION!		Bracket	
Discussion				Fixing nails	
Shape, dimensions and distinguishing characteristics				Shroud pins	
LID				Fabric	
HEAD				Other finds	
BASE					
Recorder: DM		Date: 21/11/00		Initials:	

**Outer Coffin**

Sample Ret.

Site Code

Context

Recording Date ..... *22/2/01* .....

*OLR00*

*1021*

Associated Numbers .....

Condition ..... *?* .....

Dep. Plate  *?*

Legible  *NO*

Inscription *Fragments of ~~text~~ that Fe w/ traces of characters ~~are~~ viewed from REV.*

Fabric lead  ormolou  brass  tin plated pewter  gilt tin   
 iron  *?* silvered tin  enamelled  other ..... Sample Ret.

Shape of dep. plate *?*

square  rectangle  shield  tapered  lozenge   
 cartouche  oval  other .....

Upholstery

colour ..... shoddy  velvet  other ..... Sample Ret.

Construction butt joint  mitred  pitched  other .....

Grip plate  Fabric = ormolou  brass  tin plated pewter  gilt tin   
 iron  silvered tin  enamelled  other ..... Sample Ret.

Grip  Fabric = ormolou  brass  iron  Sample Ret.

Design swag of rose  horseshoe  cherub's head  plain   
 other .....

Grip bolts  Corner bolts  Type = gilt brass  brass  iron   
 other ..... Sample Ret.

Lid motifs  other ..... Sample Ret.

Escutcheons  other ..... Sample Ret.

Upholstery <sup>*studs*</sup> ~~nails~~  brass  gilt brass  silvered brass  iron  enamelled   
 other ..... *2 x 0000 = 8 studs* ..... Sample Ret.

Fixings  panel nails  screws  hinges  lace  Sample Ret.

Timber type ..... Sample Ret.

Interpretation / Comments

.....  
 .....

SITE		COFFIN RECORD SHEET		CONTEXT NO.	
OUR 00		Additional sheets: YES x 1.		1022	
Trench:		Grave fills		Treatment: BONES LIFTED BUT NOT KEPT	
Site sub-div: S.E.		Grave cut:		Finds	
Plan no: 6		Skeleton:		None	
Section no:		Matrix location: 1022		Breastplate ✓	
Co-ordinates:		Preservation:		Grip	
Levels		Neg No:		Hinge	
Slide No.				Bracket	
				Fixing nails	
				Shroud pins	
				Fabric	
				Other finds	

**Description** E-W Pb COFFIN. OUTER Pb-BREASTPLATE. BURIAL MADE OUT AS TOO NEAR TO VERY HIGH SECTION. BODY WRAPPED INTO LINEN SHROUD. SKELETON WAS ACCOMPANIED WITH PRESERVED BODY FAT AND

**Discussion** THE BODY WAS NOT KEPT FOR ANALYSIS. DNA SAMPLE HAS NOT BEEN OBTAINABLE.

Shape, dimensions and distinguishing characteristics

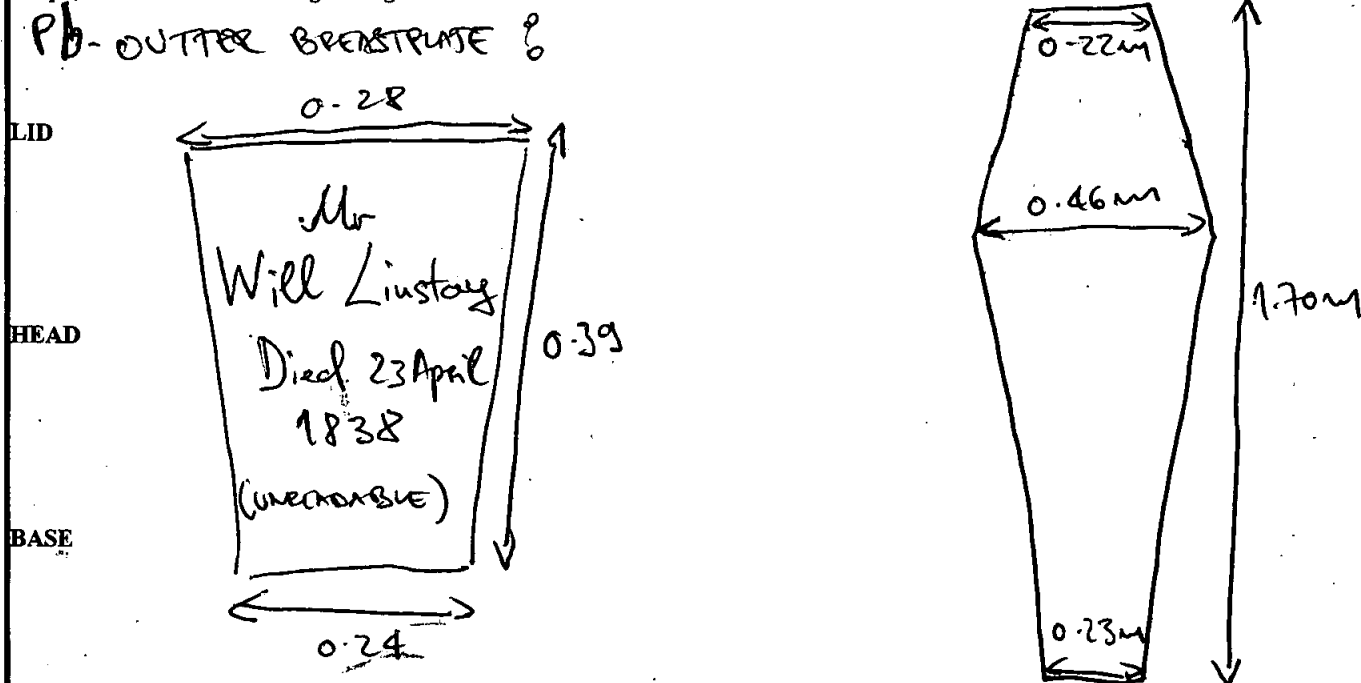

Recorder: OH Date: 21/10/00 Initials:

Site Code

Context

**Outer Coffin**

Sample Ret.

OR100

1022

Recording Date ..... 22/11

Associated Numbers .....

Condition ..... 2

Dep. Plate

Legible

Inscription "Mr/Will<sup>m</sup> Linsley/Died 23<sup>rd</sup> Apr<sup>il</sup>/1838/In his 68<sup>th</sup> yr"

same as 776  
w/ 534-outer border.

Fabric lead

ormolou

brass

tin plated pewter

gilt tin

iron

silvered tin

enamelled

other .....

Sample Ret.

**Shape of dep. plate**

square

rectangle

shield

tapered

lozenge

cartouche

oval

other .....

**Upholstery**

colour .....

shoddy

velvet

other .....

Sample Ret.

**Construction**

butt joint

mitred

pitched

other .....

**Grip plate**

Fabric = ormolou

brass

tin plated pewter

gilt tin

iron

silvered tin

enamelled

other .....

Sample Ret.

**Grip**

Fabric = ormolou

brass

iron

Sample Ret.

**Design**

swag of rose

horseshoe

cherub's head

plain

other .....

**Grip bolts**

**Corner bolts**

Type = gilt brass

brass

iron

other ..... Sample Ret.

**Lid motifs**

other ..... Sample Ret.

**Escutcheons**

other ..... Sample Ret.

**Upholstery nails**

brass

gilt brass

silvered brass

iron

enamelled

other ..... Sample Ret.

**Fixings**

panel nails

screws

hinges

lace

Sample Ret.

**Timber type** .....

Sample Ret.

**Interpretation / Comments**

.....  
.....

dh

SITE OUR 00	COFFIN RECORD SHEET	CONTEXT NO. 1023
Trench:	Additional sheets: 4x5 x 1.	Treatment: BONES LIFTED
Site sub-div: S.C.	Grave fills	
Plan no: 6	Grave cut:	Finds None
Section no:	Skeleton:	Breastplate Grip
Co-ordinates:	Matrix location: (1023) v/L (1024)	Hinge Bracket
Levels	Preservation: GOOD	Fixing nails Shroud pins
Slide No.	Neg No:	Fabric Other finds

**Description** E-W ADULT BURIAL. WOODEN COFFIN.

**Discussion** Poss mixing with 1024.  
Bones of further 3 individuals present.  
See skeleton recording sheet for full details on which bones are present.

Shape, dimensions and distinguishing characteristics

LID

HEAD

BASE

Recorder: DM	Date: 22/11/00	Initials:
--------------	----------------	-----------



# Coffin Recording Sheet

Site Code

Context

**Outer Coffin**

Sample Ret.

02200

1023

Recording Date ..... 6/12/00 .....

Associated Numbers .....

Condition .....

Dep. Plate

Legible

Inscription

Fabric lead  ormolou  brass  tin plated pewter  gilt tin   
 iron  silvered tin  enamelled  other ..... Sample Ret.

**Shape of dep. plate**

square  rectangle  shield  tapered  lozenge   
 cartouche  oval  other .....

**Upholstery**

colour ..... shoddy  velvet  other ..... Sample Ret.

**Construction**

butt joint  mitred  pitched  other .....

Grip plate  Fabric = ormolou  brass  tin plated pewter  gilt tin   
 iron  silvered tin  enamelled  other ..... Sample Ret.   
*Frag on rev of grip-unid.*

Grip  Fabric = ormolou  brass  iron  Sample Ret.

Design swag of rose  horseshoe  cherub's head  (36) plain   
 other .....

Grip bolts  Corner bolts  Type = gilt brass  brass  iron   
 other ..... Sample Ret.

Lid motifs  other ..... Sample Ret.

Escutcheons  other ..... Sample Ret.

Upholstery nails  brass  gilt brass  silvered brass  iron  enamelled   
 other ..... Sample Ret.

Fixings  panel nails  screws  hinges  lace  Sample Ret.

Timber type ..... Sample Ret.

**Interpretation / Comments**

.....  
 .....

SITE		COFFIN RECORD SHEET		CONTEXT NO.	
OUR 00				1024	
Trench:		Additional sheets:		Treatment:	
Site sub-div: S.E.		Grave fills		BONES LIFTED	
Plan no: 6		Grave cut:		Finds	
Section no:		Skeleton:		None	
Co-ordinates:		Matrix location:		Breastplate	
		(1024) o/l (1023)		Grip	
Levels		Preservation:		Hinge	
				Bracket	
Slide No.:		Neg No.:		Fixing nails	
				Shroud pins	
				Fabric	
				Other finds:	

**Description** E-W INFANT BURIAL. STARTING ON TOP OF ADULT BURIAL  
 (1023)

**Discussion**

**Shape, dimensions and distinguishing characteristics**

LID

HEAD

BASE

Recorder: DM	Date: 22/11/00	Initials:
--------------	----------------	-----------

SITE: <u>01R08</u>		COFFIN RECORD SHEET		CONTEXT NO. <u>1025</u>	
Trench:		Additional sheets: <u>yes x1</u>		Treatment:	
Site sub-div: <u>S.E.</u>		Grave fills		<u>BONES LIFTED</u>	
Plan no: <u>6</u>		Grave cut:		Finds	
Section no:		Skeleton:		None	
Co-ordinates:		Matrix location: <u>1025</u> U/L <u>1023</u>		Breastplate	
Levels		Preservation:		Grip <input checked="" type="checkbox"/>	
Slide No.		Neg No:		Hinge	
Description		E-W. ADULT BURIAL, WOODEN COFFIN.		Bracket	
Discussion		Extra bones: R 1st - 3rd Mc } L Trapezium }		All large & robust Male?? From same individual 1023??	
Shape, dimensions and distinguishing characteristics					
LID					
HEAD					
BASE					
Recorder: <u>DM</u>		Date: <u>22/11/00</u>		Initials:	

**Outer Coffin**

Sample Ret.

Site Code

Context

Recording Date ..... 13/2/01 .....

OLR00

1025

Associated Numbers .....

Condition .....

Dep. Plate

Legible

Inscription

Fabric lead  ormolou  brass  tin plated pewter  gilt tin   
 iron  silvered tin  enamelled  other ..... Sample Ret.

**Shape of dep. plate**

square  rectangle  shield  tapered  lozenge   
 cartouche  oval  other .....

**Upholstery**

colour ..... shoddy  velvet  other ..... Sample Ret.

**Construction**

butt joint  mitred  pitched  other .....

Grip plate  Fabric = ormolou  brass  tin plated pewter  gilt tin   
 iron  *Feeds on rev of grip-wood* silvered tin  enamelled  other ..... Sample Ret.

Grip  Fabric = ormolou  brass  iron  *x1* Sample Ret.

Design swag of rose  horseshoe  cherub's head  3b plain   
 other .....

Grip bolts  Corner bolts  Type = gilt brass  brass  iron

other ..... Sample Ret.

Lid motifs  other ..... Sample Ret.

Escutcheons  other ..... Sample Ret.

Upholstery nails  brass  gilt brass  silvered brass  iron  enamelled   
 other ..... Sample Ret.

Fixings  panel nails  screws  hinges  lace  Sample Ret.

Timber type ..... Sample Ret.

**Interpretation / Comments**

.....  
 .....

Islington, Old Street, St Lukes  
OLROD

Box 4 File 2

B. PRIMARY Contact Record - N<sup>o</sup> 1026-1157

SCAN PDF

FILMING INSTRUCTIONS

Submitter OASouth

No. of CD copies: 2

Headings

Site information

Line 1: [OASouth] County:[Greater London] Parish:[Islington] Site:[Old Street, St Lukes]

Site code[OLR00]

Line 2: Excavators name[A. Boyle]

Line 3:

Classification of material

Tick if present

Index to archive	
Introduction	
A:Final Report	
A:Publication Report	
B:Site Data – Text: Diary/Daybook/Fieldnotes	
B: Site Data – Text: General Summaries	
B: Site Data – Text: Primary Context Records n° 1026 - 1157	✓
B: Site Data – Text: Synthesised Context Records	
B: Site Data – Text: Survey Reports	
B: Site Data – Text: Catalogue of Drawings	
B: Site Data – Text: Primary Drawings	
B: Site Data – Text: Synthesised Drawings	
C: Finds Data – Text: Primary Finds Data	
C: Finds Data – Text: Synthesised Finds Data	
C: Finds Data – Text: Specialist Reports	
C: Finds Data – Text: Box/Bag List	
D: Catalogue of Photos/Slides/Videos/X--rays	
E: Environmental/Ecofact Data: Primary Records	
E: Environmental/Ecofact Data: Synthesised Records	
E: Environmental/Ecofact Data: Specialist Reports	
F: Documentary	
F: Press and Publicity	
G: Correspondence	
H: Miscellaneous	

SITE CODE: 01200		CONTEXT CHECKLIST			SITE NAME: ST LUKES CHURCH, ISLINGTON			
Context No	Type	Excavated with Segments	Relationships	Dug	Drawn		NAMES?	Comments
					Section	Plan		
B 1026	Burial	S.C.	U/L 1025	DM	—	G	N	BURIAL - INFANT
B 1027	"	"	O/L 1028	DM	—	G	N	BURIAL - ADULT
B 1028	"	"	U/L 1027	DM	—	G	N	BURIAL - ADULT
B 1029	"	"	O/L 1030	DM	—	G	N	BURIAL - INFANT
B 1030	"	"	U/L 1029	DM	—	G	N	BURIAL - ADULT
B 1031	"	"	U/L 1030	DM	—	G	N	BURIAL - ADULT
B 1032	"	"	O/L 1033	DM	—	G	N	BURIAL - ADULT
B 1033	"	"	U/L 1032	DM	—	G	N	BURIAL - ADULT
B 1034	"	"		DM	—	G	N	BURIAL - ADULT
B 1035	"	"	O/L 1036	DM	—	G	N	Pb COFFIN - ADULT
B 1036	"	"	U/L 1035	DM	—	G	N	BURIAL - ADULT
B 1037	"	"	U/L 1036	DM	—	G	N	Pb COFFIN - ADULT
B 1038	"	"	O/L 1039	DM	—	G	N	BURIAL - ADULT
B 1039	"	"	U/L 1038	DM	—	G	N	Pb COFFIN - ADULT
B 1040	"	"	U/L 1039	DM	—	G	N	Pb COFFIN - ADULT
B 1041	"	"	U/L 1037	DM	—	G	N	BURIAL - ADULT
B 1042	"	"	U/L 1041	DM	—	G	N	BURIAL - ADULT
B 1043	"	"	U/L 1040	DM	—	G	N	"
B 1044	"	"	U/L 1042	DM	—	G	N	"
B 1045	"	"	U/L 1043	DM	—	G	N	"
B 1046	"	"	U/L 1045	DM	—	G	N	"
B 1047	"	"	O/L 1048	DM	—	G	N	BURIAL - ADULT
B 1048	"	"	O/L 1049	DM	—	G	N	"
B 1049	"	"	U/L 1048	DM	—	G	N	"
B 1050	"	"	U/L 1049	DM	—	G	N	"
B 1051	"	"	U/L 1050	DM	—	G	N	"
B 1052	"	"		DM	—	G	N	BURIAL - JUVENILE
B 1053	"	"		DM	—	G	N	BURIAL - JUVENILE
B 1054	"	"		DM	—	G	N	BURIAL - ADULT
B 1055	"	"		DM	—	G	N	"
B 1056	"	"		DM	—	G	N	"
B 1057	"	"	U/L 1058	DM	—	G	N	BURIAL - ADULT
B 1058	"	"	O/L 1057	DM	—	G	N	BURIAL - JUVENILE

BURIALS THIS SHEET = 33

SITE		CONTEXT				SITE		Matrix normed	Comments
CODE:		CHECKLIST				NAME:			
Context No	Type	Excavated with Segments	Relationships	Dug	Drawn				
					Section	Plan			
B	1059	Burial	NC	in w/ 452	FR	/	/	/	burial from 452.
-	1060	Burial	Crypt Bay 3	adj to 991	D <sup>u</sup> M	/	7	Y	infant p.b coffin
-	1061	Burial	" " "	adj to 992	D <sup>u</sup> M	/	7	Y	sub adult p.b coffin
DNA/B	1062	Burial	" " "	o/c 1063	D <sup>u</sup> M	/	7	Y	adult p.b coffin
-	1063	Burial	" " "	u/l 1062	D <sup>u</sup> M	/	7	N	adult pb coffin
-	1064	Burial	" " "	o/c 1063	D <sup>u</sup> M	/	7	N	adult pb coffin
DNA/B	1065	Burial	" " "	u/l 1064	D <sup>u</sup> M	/	7	Y	adult pb coffin
-	1066	Burial	Crypt Bay A	adj to 1067	D <sup>u</sup> M	/	7	Y	adult pb coffin
DNA/B	1067	Burial	" " "	adj to 1066 & 1068	D <sup>u</sup> M	/	7	Y	adult pb coffin
DNA/B	1068	Burial	" " "	adj to 1067 & 1069	D <sup>u</sup> M	/	7	Y	adult pb coffin
DNA/B	1069	Burial	" " "	adj to 1068 & 1070	D <sup>u</sup> M	/	7	Y	adult pb coffin
B	1070	Burial	" " "	u/l 1071 adj to 1069	D <sup>u</sup> M	/	7	N	sub adult pb coffin
DNA/B	1071	Burial	" " "	o/c 1070	D <sup>u</sup> M	/	7	Y	adult pb coffin
B	1072	Burial	" " "	u/l 1069	D <sup>u</sup> M	/	7	Y	infant p.b coffin
-	1073	Burial	" " "	adj to 1071	D <sup>u</sup> M	/	7	Y	adult p.b coffin
1074	1074	"	" BA12	adj to 915	T <sub>2</sub>	/	7	Y	"
B	1075	"	" BA12	adj to 918	T <sub>2</sub>	/	7	Y	"
-	1076	Burial	Crypt Bay A	-	D <sup>u</sup> M	/	7	Y	Sub adult p.b coffin
-	1077	Burial	"	-	D <sup>u</sup> M	/	7	Y	Sub adult p.b coffin
-	1078	Burial	"	-	D <sup>u</sup> M	/	7	Y	adult pb coffin
-	1079	Burial	"	o/c 1082	D <sup>u</sup> M	/	7	Y	adult pb coffin
-	1080	Burial	"	o/c 1083	D <sup>u</sup> M	/	7	Y	adult pb coffin
-	1081	Burial	Crypt Bay A	-	D <sup>u</sup> M	/	7	N	adult pb coffin
-	1082	Burial	"	u/l 1079	D <sup>u</sup> M	/	7	Y	adult pb coffin
-	1083	Burial	"	u/l 1080	D <sup>u</sup> M	/	7	N	sub adult pb coffin
-	1084	Burial	"	-	D <sup>u</sup> M	/	7	Y	sub adult p.b coffin
B/DNA	1085	Burial	Crypt Bay A	-	D <sup>u</sup> M	/	7	Y	adult p.b coffin
B/DNA	1087	Burial	"	-	D <sup>u</sup> M	/	7	Y	adult pb coffin
B/DNA	1088	Burial	" " "	adj. 1086	D <sup>u</sup> M	/	7	Y	adult pb coffin
-	1089	Burial	Crypt Bay A	-	T <sub>2</sub>	/	7	Y	adult pb coffin
-	1090	Burial	Crypt Bay A	-	D <sup>u</sup> M	/	7	Y	adult pb coffin
-	1091	Burial	Crypt Bay A	adj to 1087	D <sup>u</sup> M	/	7	N	adult pb coffin

BURIALS THIS SHEET = 33

woops. \* 1085 Burial/Crypt Bay A u/l 1081 10<sup>u</sup>M / 7 | N | infant p.b coffin



SITE: OLROO		CONTEXT CHECKLIST			SITE ST LUCES CHURCH			
CODE:					NAME: ISLINGTON			
Context No	Type	Excavated with Segments	Relationships	Dug	Drawn		Matrix	Comments
					Section	Plan		
1092	STRUC		overlies (332)	DS	14			MODERN PATHWAY
1093	<del>STRUC</del>	<del>XXXXXX</del>	<del>VOID</del>	<del>XXXXXX</del>	<del>XXXXXX</del>	<del>XXXXXX</del>	<del>XXXXXX</del>	<del>XXXXXX</del>
1094	LAYER		overlies (1095)		14			Burned topsoil
1095	LAYER		Overlies (1096)		14			gravel make up or early path.
1096	LAYER		overlies (1097)		14			made ground
1097	LAYER		overlies (1098)		14			Post med make up
1098	LAYER		overlies (1099)		14			Post med make up
1099	LAYER		overlies (1100)		14/19			Post med make up
1100	LAYER		overlies (1104)		14/19			Post med make up
1101	LAYER		overlies (1102) (1103)		14			dump deposit (20 landscaping)
1102	LAYER		overlies (1103)		14			P.M. made ground
1103	LAYER		overlain by (1102) (1101)		14/19			GRAVEYARD SOIL (SC)
1104	LAYER		overlies (1105)		19			Brickwork - NATURAL
1105	LAYER		overlain by (1104) (1103)		19			Gravel - NATURAL
1106	LAYER		overlies (1101)	✓	19			modern topsoil
B 1107	BURIAL	NC	with (330)	DS		3		Burial
B 1108	BURIAL	SC	O/L 1110	B <sub>2</sub>	—	6	N	BURIAL - ADULT
B 1109	BURIAL	SC	O/L 1111	T <sub>2</sub>	—	6	N	"
B 1110	"	"	V/L 1108	DM	—	6	N	"
B 1111	"	"	V/L 1109	DM	—	6	N	"
B 1112	"	"	V/L 1111	DM	—	6	N	"
B 1113	"	"	V/L 1112	DM	—	6	N	"
B 1114	"	SC	V/L 1110	DM <sub>2</sub>	—	6	N	"
B 1115	"	SC		DM	—	6	N	BURIAL - ADULT
B 1116	STONE	SC	V/L 1115	DM	—	6		COBBLED SURFACE
B 1117	BURIAL	SC	"	DM	—	6	N	BURIAL - ADULT
B 1118	"	"	"	DM	—	6	N	BURIAL - ADULT
B 1119	"	"	O/L 1120	DM	—	6	N	BURIAL - ADULT
B 1120	"	"	V/L 1119	DM	—	6	N	BURIAL - ADULT
B 1121	"	"	"	DM	—	6	N	BURIAL - ADULT
B 1122	"	"	O/L 1123	DM	—	6	N	BURIAL - INFANT
B 1123	"	"	V/L 1122	DM	—	6	N	BURIAL - INFANT
B 1124	"	"	O/L 1158	DM	—	6	N	BURIAL - ADULT

BURIALS THIS SHEET = 17

SITE		CONTEXT				SITE		
CODE: <i>aloo</i>		CHECKLIST				NAME:		
Context No	Type	Excavated with Segments	Relationships	Dug	Drawn		Matrix	Comments
					Section	Plan		
1125	Burial	crypt boy		Yes		7	Y	infant pb coffin
1126	Burial	"	U/L 845	Yes		7	Y	"
1127	Burial	crypt boy		Yes		7	Y	infant pb coffin
1128	Burial	"		Yes		7	Y	adult pb coffin
1129	Burial	"		Yes		7	N	adult pb coffin
1130	Burial	"		Yes		7	Y	adult pb coffin
1131	"	"		Yes		7	Y	"
1132	"	"		Yes		7	Y	"
1133	"	"		Yes		7	Y	"
1134	Burial	crypt boy		Yes		7	N	infant pb coffin
1135	"	"	U/L 845	Yes		7	Y	adult pb coffin
1136	"	"		Yes		7	N	"
1137	"	"	0/L 1138	Yes		7	N	"
1138	"	"		Yes		7	N	"
1139	"	"	U/L 1137	Yes		7	N	"
1140	"	"		Yes		7	Y	"
1141	Burial	crypt boy	U/L 1081	DEM		7	Y	adult pb coffin
1142	"	"	U/L 1129	DEM		7	Y	adult pb coffin
1143	Burial	"SC	off 1147 vault 1160	DEM		36	Y	adult pb coffin
1144	Burial	"SC	off 1146 vault 1160	DEM		36	Y	adult pb coffin
1145	Burial	"SC	vault 1160	DEM		36	Y	adult pb coffin
1146	Burial	"SC	U/L 1144 V 1160	DEM		36	Y	adult pb coffin
1147	Burial	"SC	U/L 1143 V 1160	DEM		36	Y	adult pb coffin
1148	Burial	"SC	U/L 1146 V 1160	DEM		6	Y	adult pb coffin
1149	Burial	"SC	U/L 1145 V 1160	DEM		36	Y	adult pb coffin
1150	Burial	crypt boy		DEM		7	N	infant pb coffin
1151	Burial	crypt boy		DEM		7	N	sub adult pb coffin
1152	Burial	"		DEM		7	N	adult pb coffin
1153	Burial	"		DEM		7	Y	adult pb coffin
1154	Burial	"		DEM		7	Y	adult pb coffin
1155	Burial	"		DEM		7	Y	adult pb coffin
1156	Burial	"		DEM		7	Y	adult pb coffin
1157	Burial	"		DEM		7	Y	adult pb coffin

SITE		COFFIN RECORD SHEET		CONTEXT NO.	
OUR 00				1026	
Trench:		Additional sheets:		Treatment:	
Site sub-div: SE,		Grave fills		BONES LIFTED	
Plan no: 6		Grave cut:		Finds	
Section no:		Skeleton:		None	
Co-ordinates:		Matrix location:		Breastplate	
		(1026) J/L (1025)		Grip	
Levels		Preservation:		Hinge	
Slide No.		Neg No:		Bracket	
				Fixing nails	
				Shroud pins	
				Fabric	
				Other finds	
Description E-W INFANT BURIAL. RELOCATED FROM PELVIS DOWNWARDS BY MOVING (1025).					
Discussion					
Shape, dimensions and distinguishing characteristics					
LID					
HEAD					
BASE					
Recorder: DM		Date: 22/11/00		Initials:	

SITE		COFFIN RECORD SHEET		CONTEXT NO.	
OUR 08				1027	
Trench:		Additional sheets: YES x1		Treatment:	
Site sub-div: S.C.		Grave fills		BONES LIFTED	
Plan no: 6		Grave cut:		Finds	
Section no:		Skeleton:		None	
Co-ordinates:		Matrix location:		Breastplate	
		(1027) o/l (102P)		Grip	
Levels:		Preservation:		Hinge	
		POOR		Bracket	
Slide No.:		Neg No.:		Fixing nails	
				Shroud pins	
Description		E-W ADULT BURIAL BADLY TRUNCATED BY UNIDENTIFIED BURIAL (102P). TRUNCATED LENGTHWISE AT ITS NORTH SIDE.			
Discussion		OVERLAPPING BUT TRUNCATED BY (102P).			
Shape, dimensions and distinguishing characteristics					
LID	Extra bones: R. Humerus R. Ulna Tibia 1/3 of midshaft				
HEAD	All large & robust, are from the same indiv. Male? Adult possibly 1028				
BASE					
Recorder: DM	Date: 22/11/00	Initials:			

**Outer Coffin**

Sample Ret.

Site Code

OLR00

Context

1027

Recording Date .....

Associated Numbers .....

Condition .....

Dep. Plate

Legible

Inscription

**Fabric** lead  ormolou  brass  tin plated pewter  gilt tin   
 iron  silvered tin  enamelled  other ..... Sample Ret.

**Shape of dep. plate**

square  rectangle  shield  tapered  lozenge   
 cartouche  oval  other .....

**Upholstery**

colour ..... shoddy  velvet  other ..... Sample Ret.

**Construction**

butt joint  mitred  pitched  other .....

**Grip plate**

**Fabric =** ormolou  brass  tin plated pewter  gilt tin   
 iron  silvered tin  enamelled  other ..... Sample Ret.

**Grip**

**Fabric =** ormolou  brass  iron  Sample Ret.

**Design**

swag of rose  horseshoe  cherub's head  plain

other .....

**Grip bolts**

**Corner bolts**  **Type =** gilt brass  brass  iron

other ..... Sample Ret.

**Lid motifs**

other ..... Sample Ret.

**Escutcheons**

other ..... Sample Ret.

**Upholstery**

<sup>studs</sup>  
~~nails~~  brass  gilt brass  silvered brass  iron  enamelled

other ..... 1 x 0 ..... Sample Ret.

**Fixings**

panel nails  screws  hinges  lace  Sample Ret.

**Timber type** .....

Sample Ret.

**Interpretation / Comments**

.....

.....

SITE OLR 00	COFFIN RECORD SHEET	CONTEXT NO. 1028
Trench:	Additional sheets: YESX1.	Treatment: BONES LIFTED
Site sub-div: S.C.	Grave fills	
Plan no: 6	Grave cut:	Findings None
Section no:	Skeleton:	Breastplate ✓ Grip ✓
Co-ordinates:	Matrix location: (1028) U/L (1027)	Hinge Bracket
Levels	Preservation: GOOD	Fixing nails Shroud pins
Slide No.	Neg No:	Fabric Other finds

**Description** E-W ADULT BURIAL, WOODEN COFFIN, FE STUDWORK. FE GRIPS AND FE GRIP-PLATES PRESENT. ~~AD~~ Pb OUTER BREASTPLATE PRESENT, BUT COMPLETELY CORRODED AND EATEN AWAY BY CORROSION, NOT READABLE. UNDERLIES (1027), BUT IT TRUNCATES IT LENGTHWISE AT ITS NORTHERN SIDE.

**Shape, dimensions and distinguishing characteristics**

LID

HEAD

BASE

Recorder: DM	Date: 22/11/00	Initials:
--------------	----------------	-----------

Site Code

Context

**Outer Coffin**

Sample Ret.

OH100

1028

Recording Date ..... 13/12/00 .....

Associated Numbers .....

Condition ..... 1 .....

Dep. Plate

Legible  NO

Inscription *Missing - enough to id it so sptfds (8)*

Fabric lead  ormolou  brass  tin plated pewter  gilt tin   
 iron  silvered tin  enamelled  other ..... Sample Ret.

*black polished.*

**Shape of dep. plate**

square  rectangle  shield  tapered  lozenge   
 cartouche  oval  other .....

**Upholstery**

colour ..... shoddy  velvet  other ..... Sample Ret.

**Construction**

butt joint  mitred  pitched  other .....

Grip plate  Fabric = ormolou  brass  tin plated pewter  gilt tin   
 iron  *frag of Fe (3)* silvered tin  enamelled  other ..... Sample Ret.   
*Black.*

Grip  Fabric = ormolou  brass  iron  X3 Sample Ret.

Design swag of rose  horseshoe  cherub's head  *(4)'s* plain

other .....

Grip bolts  Corner bolts  Type = gilt brass  brass  iron

other ..... Sample Ret.

Lid motifs  other *frag (Hermes) of Fe uen, not enough to id.* Sample Ret.

Escutcheons  other .....

Upholstery *studs*  brass  gilt brass  silvered brass  iron  enamelled

other *x 1 piece* *6 studs in total.* Sample Ret.

Fixings  panel nails  screws  hinges  lace  Sample Ret.

Timber type ..... Sample Ret.

**Interpretation / Comments**

.....  
 .....

SITE. OLR 00		COFFIN RECORD SHEET		CONTEXT NO. 1029	
Trench:		Additional sheets:		Treatment: BONES LIFTED	
Site sub-div: S.E.		Grave fills:			
Plan no: 6		Grave cut:		Finds None	
Section no:		Skeleton:		Breastplate Grip ✓	
Co-ordinates:		Matrix location: (1029) O/L (1030)		Hinge Bracket	
Levels:		Preservation: POOR		Fixing nails Shroud pins	
Slide No.:		Neg No.:		Fabric Other finds	
<p>Description: E-W INFANT BURIAL. BABY TRUNCATED FROM TOP PROFILE. NOT MUCH OF THE SKELETON SURVIVES. CU ALLOT STUDWORK.</p> <p>Discussion:</p>					
<p>Shape, dimensions and distinguishing characteristics</p> <p>LID</p> <p>HEAD</p> <p>BASE</p>					
Recorder: DM		Date: 22/11/00		Initials:	



**Outer Coffin**

Sample Ret.

Site Code

Context

Recording Date ..... 21/2/01 .....

OLR00

1029

Associated Numbers .....

Condition .....

Dep. Plate

Legible

Inscription

Fabric lead  ormolou  brass  tin plated pewter  gilt tin   
 iron  silvered tin  enamelled  other ..... Sample Ret.

**Shape of dep. plate**

square  rectangle  shield  tapered  lozenge   
 cartouche  oval  other .....

**Upholstery**

colour ..... shoddy  velvet  other ..... Sample Ret.

**Construction**

butt joint  mitred  pitched  other .....

Grip plate  Fabric = ormolou  brass  tin plated pewter  gilt tin   
 iron  *progs on rev. of grip-wood.* silvered tin  enamelled  other ..... Sample Ret.

Grip  Fabric = ormolou  brass  iron  <sup>1x</sup> Sample Ret.

Design swag of rose  horseshoe  cherub's head  <sup>①</sup> plain   
 other .....

Grip bolts  Corner bolts  Type = gilt brass  brass  iron

other ..... Sample Ret.

Lid motifs  other ..... Sample Ret.

Escutcheons  other ..... Sample Ret.

Upholstery nails  brass  gilt-brass  silvered brass  iron  enamelled   
 other ..... Sample Ret.

Fixings  panel nails  screws  hinges  lace  Sample Ret.

Timber type ..... Sample Ret.

**Interpretation / Comments**

.....  
 .....

SITE	COFFIN RECORD SHEET	CONTEXT NO.
OLR 00		1030
Trench:	Additional sheets:	Treatment:
Site sub-div: S.C.	Grave fills	BONES LIFTED
Plan no: 6	Grave cut:	Finds
Section no:	Skeleton:	None
Co-ordinates:	Matrix location:	Breastplate
Levels	(1030) u/L (1029)	Grip
Slide No.	Preservation:	Hinge
		Bracket
		Fixing nails
		Shroud pins
		Fabric
		Other finds
<p>Description</p> <p>E-W ADULT BURIAL, WOODEN COFFIN  VERY CLOSE TO UNDERLYING (1031) BONES SHOULD BE LOOKED  AT TOGETHER. POSSIBLE MIXING!</p> <p>Discussion</p>		
<p>Shape, dimensions and distinguishing characteristics</p> <p>LID</p> <p>HEAD</p> <p>BASE</p>		
Recorder: DM	Date: 22/11/00	Initials:

SITE		COFFIN RECORD SHEET		CONTEXT NO.	
OLR 00				1031	
Trench:		Additional sheets:		Treatment:	
Site sub-div: S.C.		Grave fills:		BONES LIFTED	
Plan no: 6		Grave cut:		Finds	
Section no:		Skeleton:		None	
Co-ordinates:		Matrix location:		Breastplate	
		(1031) u/L (1030)		Grip	
Levels:		Preservation:		Hinge	
				Bracket	
Slide No.:		Neg No.:		Fixing nails	
				Shroud pins	
				Fabric	
				Other finds	
<p>Description E-W ADULT BURIAL, WOODEN COFFIN. Fe STUDWORK. VERY CLOSE TO OVERLYING (1030) BONES SHOULD BE LOOKED AT TOGETHER - POSSIBLE MIXING.</p> <p>Discussion</p>					
<p>Shape, dimensions and distinguishing characteristics</p> <p>LID</p> <p>HEAD</p> <p>BASE</p>					
Recorder: DM		Date: 22/10/00		Initials:	

dy

SITE OLP 00	COFFIN RECORD SHEET	CONTEXT NO. 1032
Trench:	Additional sheets: 465 x 1	Treatment: BONES LIFTED
Site sub-div: S.C.	Grave fills	
Plan no: 6	Grave cut:	Finds None
Section no:	Skeleton:	Breastplate Grip
Co-ordinates:	Matrix location: 1032 o/L 1033	Hinge Bracket
Levels	Preservation: Good	Fixing nails Shroud pins
Slide No.	Neg No:	Fabric Other finds

**Description**  
E-W ADULT BURIAL, WOODEN COFFIN,  
W-ANDY STUDWORK.

**Discussion**  
Extra right clavicle - 1033?

**Shape, dimensions and distinguishing characteristics**

LID

HEAD

BASE

Recorder: DM	Date: 22/11/00	Initials:
--------------	----------------	-----------

Site Code

Context

**Outer Coffin**

Sample Ret.

04200

1032

Recording Date ..... 8/12/00 .....

Associated Numbers .....

Condition ..... 1 .....

Dep. Plate

Legible

Inscription *6x 1/2 frags, flat straight & w/ traces of letters? illegible.*

Fabric lead  ormolou  brass  tin plated pewter  gilt tin   
iron  silvered tin  enamelled  other ..... Sample Ret.

**Shape of dep. plate**

square  rectangle  shield  tapered  lozenge   
cartouche  oval  other .....

**Upholstery**

colour ..... shoddy  velvet  other ..... Sample Ret.

**Construction**

butt joint  mitred  pitched  other .....

Grip plate  Fabric = ormolou  brass  tin plated pewter  gilt tin   
iron  silvered tin  enamelled  other ..... Sample Ret.

Grip  Fabric = ormolou  brass  iron  Sample Ret.

Design swag of rose  horseshoe  cherub's head  plain   
other .....

Grip bolts  Corner bolts  Type = gilt brass  brass  iron   
other ..... Sample Ret.

Lid motifs  other .....

Escutcheons  other .....

Upholstery nails  brass  gilt brass  silvered brass  iron  enamelled   
other ..... Sample Ret.

Fixings  panel nails  screws  hinges  lace  Sample Ret.

Timber type ..... Sample Ret.

**Interpretation / Comments**

.....  
.....

SITE	OLR 00	COFFIN RECORD SHEET	CONTEXT NO.	1033
Trench:		Additional sheets:	4/8 x 1	
Site sub-div:	S.C.	Grave fills	Treatment: BONES LIFTED	
Plan no:	6	Grave cut:	Finds None	
Section no:		Skeleton:	Breastplate Grip ✓	
Co-ordinates:		Matrix location:	Hinge Bracket	
Levels		Preservation:	Fixing nails Shroud pins	
Slide No.		Neg No:	Fabric Other finds	

**Description** E-W ADULT BURIAL. WOODEN COFFIN.  
 CW-ALLOY STUD WORK. FE GRIP PRESENT.

**Discussion**

**Shape, dimensions and distinguishing characteristics**

LID

HEAD

BASE

Recorder:	DM	Date:	22/11/00	Initials:	
-----------	----	-------	----------	-----------	--

# Coffin Recording Sheet

Site Code

Context

**Outer Coffin**

Sample Ret.

02000

1033

Recording Date ..... 14/2/01 .....

Associated Numbers .....

Condition .....

Dep. Plate

Legible

Inscription

Fabric lead  ormolou  brass  tin plated pewter  gilt tin   
 iron  silvered tin  enamelled  other ..... Sample Ret.

**Shape of dep. plate**

square  rectangle  shield  tapered  lozenge   
 cartouche  oval  other .....

**Upholstery**

colour ..... shoddy  velvet  other ..... Sample Ret.

**Construction**

butt joint  mitred  pitched  other .....

**Grip plate**

*Fabric = ormolou*  brass  tin plated pewter  gilt tin   
*frag on rev of grip-unid*  
 iron  silvered tin  enamelled  other ..... Sample Ret.

**Grip**

*Fabric = ormolou*  brass  iron  *x1* Sample Ret.

**Design**

swag of rose  horseshoe  cherub's head  *(1)* plain

other .....

**Grip bolts**

**Corner bolts**  Type = gilt brass  brass  iron

other ..... Sample Ret.

**Lid motifs**

other ..... Sample Ret.

**Escutcheons**

other ..... Sample Ret.

**Upholstery**

*studs*  
*nails*  brass  gilt brass  silvered brass  iron  enamelled   
 other ..... *1x piece* *8 8000 = 13 studs* Sample Ret.

**Fixings**

panel nails  screws  hinges  lace  Sample Ret.

**Timber type** .....

Sample Ret.

**Interpretation / Comments**

.....  
 .....

SITE		COFFIN RECORD SHEET		CONTEXT NO.	
02R00		Additional sheets: YES.		Treatment: BONES LIFTED	
Trench:		Grave fills		Finds	
Site sub-div:		Grave cut:		None	
Plan no:		Skeleton:		Breastplate	
Section no:		Matrix location: (1034)		Grip ✓	
Co-ordinates:		Preservation:		Hinge	
Levels		Neg No:		Bracket	
Slide No.				Fixing nails	
				Shroud pins	
				Fabric	
				Other finds	
Description E-W ADULT BURIAL, WOODEN COFFIN					
Discussion					
Shape, dimensions and distinguishing characteristics					
LID					
HEAD					
BASE					
Recorder: DM		Date: 23/11/00		Initials:	



**Outer Coffin**

Sample Ret.

Site Code

OR100

Context

1034

Recording Date .....

Associated Numbers ..... 1265 (neo note)

Condition .....

Dep. Plate

Legible

Inscription

Fabric lead  ormolou  brass  tin plated pewter  gilt tin   
 iron  silvered tin  enamelled  other ..... Sample Ret.

**Shape of dep. plate**

square  rectangle  shield  tapered  lozenge   
 cartouche  oval  other .....

**Upholstery**

colour ..... shoddy  velvet  other ..... Sample Ret.

**Construction**

butt joint  mitred  pitched  other .....

**Grip plate**

Fabric = ormolou  brass  tin plated pewter  gilt tin   
 iron  silvered tin  enamelled  other ..... Sample Ret.   
*Frogs on rev of grip-wood.*

**Grip**

Fabric = ormolou  brass  iron  xi Sample Ret.

**Design**

swag of rose  horseshoe  cherub's head  (3b) plain

other .....

**Grip bolts**

**Corner bolts**  Type = gilt brass  brass  iron

other ..... Sample Ret.

**Lid motifs**

other ..... Sample Ret.

**Escutcheons**

other ..... Sample Ret.

**Upholstery nails**

brass  gilt brass  silvered brass  iron  enamelled

other ..... Sample Ret.

**Fixings**

panel nails  screws  hinges  lace  Sample Ret.

**Timber type**

..... Sample Ret.

**Interpretation / Comments**

.....  
 .....

SITE	COFFIN RECORD SHEET	CONTEXT NO.
01R00		1035
Trench:	Additional sheets: YES x1	Treatment:
Site sub-div: S.C.	Grave fills	BONES LIFTED
Plan no: 6	Grave cut:	Finds
Section no:	Skeleton:	None
Co-ordinates:	Matrix location:	Breastplate
Levels	(1035) o/c (1036)	Grip ✓
Slide No.	Preservation:	Hinge
		Bracket
		Fixing nails
		Shroud pins
	Neg No:	Fabric
		Other finds

Description Pb - COFFIN - E-W. ADULT.  
 COFFIN COMPLETELY TRUNCATED FROM FEET UPWARDS.  
 ONLY FEET BONES FOUND.

Discussion

Shape, dimensions and distinguishing characteristics

LID

HEAD

BASE

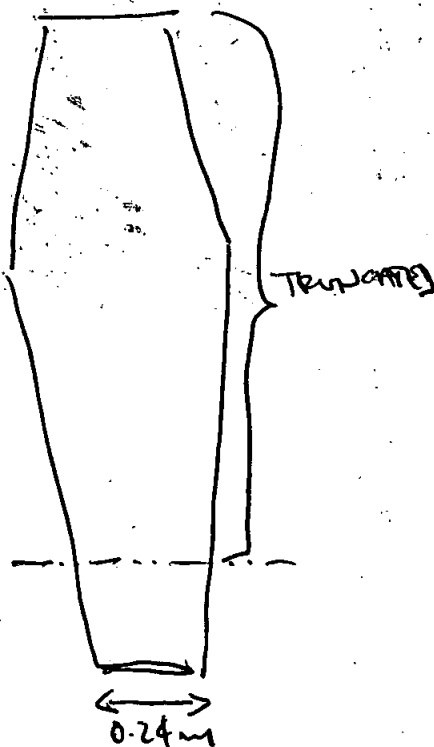

Recorder: DM	Date: 23/11/00	Initials:
--------------	----------------	-----------

Site Code

Context

**Outer Coffin**

Sample Ret.

*OL200*

*1035*

Recording Date ..... *14/2/01* .....

Associated Numbers .....

Condition .....

Dep. Plate

Legible

Inscription

Fabric lead  ormolou  brass  tin plated pewter  gilt tin   
 iron  silvered tin  enamelled  other ..... Sample Ret.

**Shape of dep. plate**

square  rectangle  shield  tapered  lozenge   
 cartouche  oval  other .....

**Upholstery**

colour ..... shoddy  velvet  other ..... Sample Ret.

**Construction**

butt joint  mitred  pitched  other .....

Grip plate  Fabric = ormolou  brass  tin plated pewter  gilt tin   
 iron  silvered tin  enamelled  other ..... Sample Ret.

Grip  Fabric = ormolou  brass  iron  *x1* Sample Ret.

Design swag of rose  horseshoe  cherub's head  *too conc. to id.* plain   
 other .....

Grip bolts  Corner bolts  Type = gilt brass  brass  iron

other ..... Sample Ret.

Lid motifs  other ..... Sample Ret.

Escutcheons  other ..... Sample Ret.

Upholstery nails  brass  gilt brass  silvered brass  iron  enamelled   
 other ..... Sample Ret.

Fixings  panel nails  screws  hinges  lace  Sample Ret.

Timber type ..... Sample Ret.

**Interpretation / Comments**

.....  
 .....

SITE		COFFIN RECORD SHEET		CONTEXT NO.	
OLR 00				1036	
Trench:		Additional sheets:		Treatment:	
Site sub-div: S.R.		Grave fills		BARS LIFTED	
Plan no: 6		Grave cut:		Finds	
Section no:		Skeleton:		None	
Co-ordinates:		Matrix location:		Breastplate	
Levels		Preservation:		Grip	
Slide No.		Neg No:		Hinge	
		(1036) U/L (1035)		Bracket	
				Fixing nails	
				Shroud pins	
				Fabric	
				Other finds	
<p>Description E-W ABOUT BURIAL. COMPUTEDY TRIMATED BY GRAVE CUT WITH STACK OF Pb-COFFINS WHICH HAS (1035) AS A TOP COFFIN. ONLY SEVERAL PIECES OF VERTEBRAE</p> <p>Discussion NONE PRESENT,</p>					
<p>Shape, dimensions and distinguishing characteristics</p> <p>LID</p> <p>HEAD</p> <p>BASE</p>					
Recorder: DM		Date: 23/11/00		Initials:	

SITE		COFFIN RECORD SHEET		CONTEXT NO.	
OUR 00				1037	
Trench:		Additional sheets:		Treatment:	
Site sub-div: S.C.		Grave fills		Bones LIFTED	
Plan no: 6		Grave cut:		Finds	
Section no:		Skeleton:		None	
Co-ordinates:		Matrix location: (1037) u/L (1036)		Breastplate	
Levels		Preservation:		Grip	
Slide No.		Neg No:		Hinge	
Description				Bracket	
Discussion				Fixing nails	
Shape, dimensions and distinguishing characteristics				Shroud pins	
LID				Fabric	
HEAD				Other finds	
BASE					
Recorder: DM		Date: 23/11/00		Initials:	

~~W~~ E-W Pb-coffin, adult, truncated heavily & from  
 REWIS UPWARDS SIMILAR TO (1035) ABOVE IT.  
 COFFIN COMPLETELY TRACKED, NOT MEASURABLE.

26

SITE OLR 00		COFFIN RECORD SHEET		CONTEXT NO. 1038	
Trench:		Additional sheets:		Treatment:	
Site sub-div: se.		Grave fills:		BONES LIFTED	
Plan no: 6		Grave cut:		Finds	
Section no:		Skeleton:		None	
Co-ordinates:		Matrix location: (1038) TRUNCATED BY 144		Breastplate	
Levels:		Preservation:		Grip	
Slide No.:		Neg No.:		Hinge	
Description		E-W ADULT BURIAL, WOODEN COFFIN.		Bracket	
Discussion		BURIAL TRUNCATED BY STRUCTURAL CUT FOR STRUCTURE 144.		Fixing nails	
Shape, dimensions and distinguishing characteristics		LID		Shroud pins	
HEAD		BASE		Fabric	
Recorder: DM		Date: 27/11/00		Other finds	

db

SITE OUR 00	COFFIN RECORD SHEET	CONTEXT NO. 1039
Trench:	Additional sheets:	Treatment: BONES LIFTED
Site sub-div: S.E.	Grave fills:	Finds None
Plan no: 6	Grave cut:	Breastplate Grip
Section no:	Skeleton:	Hinge Bracket
Co-ordinates:	Matrix location: (1039) U/L (1038)	Fixing nails Shroud pins
Levels:	Preservation: POOR	Fabric <input checked="" type="checkbox"/> Other finds
Slide No.:	Neg No.:	

**Description**  
E-W PL-COFFIN-ADULT. COMPLETELY CRASHED, NOT MUCH OF THE COFFIN SURVIVES, TRUNCATED FROM PELTS DOWN. MEASUREMENTS OF THE COFFIN NOT OBTAINABLE.

**Discussion**  
contains 'punched lace' lining veil fragments.

Shape, dimensions and distinguishing characteristics

LID

HEAD

BASE



Recorder: DH	Date: 27/11/00	Initials:
-----------------	-------------------	-----------

SITE	COFFIN RECORD SHEET	CONTEXT NO.
OUR 00		1040
Trench:	Additional sheets:	Treatment:
Site sub-div: S.E.	Grave fills:	BONES LIFTED
Plan no: 6	Grave cut:	Finds
Section no:	Skeleton:	None
Co-ordinates:	Matrix location: (1040) U/L (1039)	Breastplate
Levels:	Preservation:	Grip
Slide No.:	Neg No.:	Hinge
		Bracket
		Fixing nails
		Shroud pins
		Fabric
		Other finds

**Description** EW Pb COFFIN. ADULT. INNER WOOD.  
 SOLDERED COFFIN PLATE PRESENT BUT TOO CORRODED TO BE  
 READABLE. SANDUST PACKING.

**Discussion**

**Shape, dimensions and distinguishing characteristics**

LID

HEAD

BASE

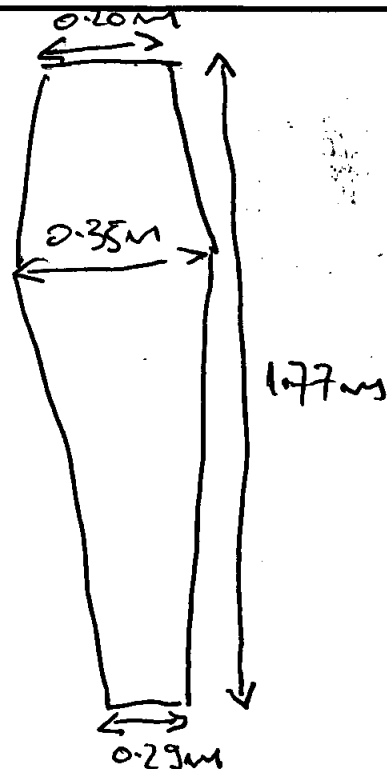

Recorder: DM	Date: 27/11/00	Initials:
--------------	----------------	-----------



db

SITE: <b>OUR 00</b>	COFFIN RECORD SHEET	CONTEXT NO. <b>1041</b>
Trench:	Additional sheets: <b>YESX1</b>	Treatment: <b>BONES LIFTED</b>
Site sub-div: <b>S.C.</b>	Grave fills	
Plan no: <b>6</b>	Grave cut:	Finds None
Section no:	Skeleton:	Breastplate Grip
Co-ordinates:	Matrix location: <b>(1041) v/c (1037)</b>	Hinge Bracket
Levels	Preservation: <b>POOR</b>	Fixing nails Shroud pins
Slide No.	Neg No:	Fabric Other finds

Description **E-W ADULT BURIAL. COMPLETELY TRUNCATED FROM FEET UP. NO FEET PRESENT.**

Discussion

Shape, dimensions and distinguishing characteristics

LID

HEAD

BASE

Recorder: <b>DM</b>	Date: <b>27/11/00</b>	Initials:
---------------------	-----------------------	-----------

# Coffin Recording Sheet

**Outer Coffin**

Sample Ret.

Site Code

Context

Recording Date ..... 12/12/00 .....

0200

1041

Associated Numbers .....

Condition .....

Dep. Plate

Legible

Inscription

Fabric lead  ormolou  brass  tin plated pewter  gilt tin   
 iron  silvered tin  enamelled  other ..... Sample Ret.

**Shape of dep. plate**

square  rectangle  shield  tapered  lozenge   
 cartouche  oval  other .....

**Upholstery**

colour ..... shoddy  velvet  other ..... Sample Ret.

**Construction**

butt joint  mitred  pitched  other .....

Grip plate  Fabric = ormolou  brass  tin plated pewter  gilt tin   
 iron  silvered tin  enamelled  other ..... Sample Ret.

Grip  Fabric = ormolou  brass  iron  X1 Sample Ret.

Design swag of rose  horseshoe  cherub's head  A plain   
 other .....

Grip bolts  Corner bolts  Type = gilt brass  brass  iron   
 other ..... Sample Ret.

Lid motifs  other ..... Sample Ret.

Escutcheons  other ..... Sample Ret.

Upholstery <sup>shel</sup> ~~nails~~  brass  gilt brass  silvered brass  iron  X2 enamelled   
 other ..... oo Sample Ret.

Fixings  panel nails  screws  hinges  lace  Sample Ret.

Timber type ..... Sample Ret.

**Interpretation / Comments**

.....  
 .....

SITE		COFFIN RECORD SHEET		CONTEXT NO.	
OLR 00				1042	
Trench:		Additional sheets:		Treatment:	
Site sub-div: S.C.		Grave fills		BONES LIFTED	
Plan no: 6		Grave cut:		Finds	
Section no:		Skeleton:		None	
Co-ordinates:		Matrix location:		Breastplate	
Levels		Preservation:		Grip <input checked="" type="checkbox"/>	
Slide No.		Neg No:		Hinge	
		(1042) U/L (1041)		Bracket	
				Fixing nails	
				Shroud pins	
				Fabric	
				Other finds	
<p>Description E-W <del>WOODEN COFFIN</del> (POSS. YOUNG ADULT). WOODEN COFFIN, JUVENILE BURIAL. LIGHT ARM MISSING.</p>					
Discussion					
Shape, dimensions and distinguishing characteristics					
LID					
HEAD					
BASE					
Recorder: DM		Date: 27/11/00		Initials:	

**Outer Coffin**

Sample Ret.

Site Code

Context

Recording Date ..... 22/2/01 .....

02200

1042

Associated Numbers .....

Condition .....

Dep. Plate

Legible

Inscription

Fabric lead  ormolou  brass  tin plated pewter  gilt tin   
 iron  silvered tin  enamelled  other ..... Sample Ret.

**Shape of dep. plate**

square  rectangle  shield  tapered  lozenge   
 cartouche  oval  other .....

**Upholstery**

colour ..... shoddy  velvet  other ..... Sample Ret.

**Construction**

butt joint  mitred  pitched  other .....

Grip plate  Fabric = ormolou  brass  tin plated pewter  gilt tin   
*frag of 228b*  
 iron  silvered tin  enamelled  other ..... Sample Ret.

Grip  Fabric = ormolou  brass  iron  *x1* Sample Ret.

Design swag of rose  horseshoe  cherub's head  *2282.* plain   
 other .....

Grip bolts  Corner bolts  Type = gilt brass  brass  iron   
 other ..... Sample Ret.

Lid motifs  other ..... Sample Ret.

Escutcheons  other ..... Sample Ret.

Upholstery nails  brass  gilt brass  silvered brass  iron  enamelled   
 other ..... Sample Ret.

Fixings  panel nails  screws  hinges  lace  Sample Ret.

Timber type ..... Sample Ret.

**Interpretation / Comments**

.....  
 .....

SITE		COFFIN RECORD SHEET		CONTEXT NO.	
OLRoo				1043	
Trench:		Additional sheets: YES x1		Treatment:	
Site sub-div: SC.		Grave fills		BONES LISTED.	
Plan no: 6.		Grave cut:		Finds	
Section no:		Skeleton:		None ✓	
Co-ordinates:		Matrix location: 1040 1043 s/l 1040		Breastplate	
Levels		Preservation:		Grip	
Slide No.		Neg No:		Hinge	
				Bracket	
				Fixing nails	
				Shroud pins	
				Fabric	
				Other finds	
<p>Description: ADULT SKEL. -E-W. WOODEN COFFIN.  VERY NEAR UNDERLYING 1045 AND 1046 AND SHOULD BE LOOKED AT TOGETHER WITH OTHER TWO.  Discussion: ALL OF THEM WERE MACHINED OUT AS FOR NEAR DANGEROUS SECTION.</p>					
Shape, dimensions and distinguishing characteristics					
LID					
HEAD					
BASE					
Recorder: Dm		Date: 27.11.00		Initials:	

# Coffin Recording Sheet

Site Code

Context

**Outer Coffin**

Sample Ret.

OL200

1043

Recording Date ..... 13/2/01 .....

Associated Numbers .....

Condition .....

Dep. Plate

Legible

Inscription

Fabric lead  ormolou  brass  tin plated pewter  gilt tin   
iron  silvered tin  enamelled  other ..... Sample Ret.

**Shape of dep. plate**

square  rectangle  shield  tapered  lozenge   
cartouche  oval  other .....

**Upholstery**

colour ..... shoddy  velvet  other ..... Sample Ret.

**Construction**

butt joint  mitred  pitched  other .....

**Grip plate**

Fabric = ormolou  brass  tin plated pewter  gilt tin   
*frags on rev of grip-wood.*  
iron  silvered tin  enamelled  other ..... Sample Ret.

**Grip**

Fabric = ormolou  brass  iron  x4 Sample Ret.

**Design**

swag of rose  horseshoe  cherub's head  <sup>(A)'s</sup> plain

other .....

**Grip bolts**

**Corner bolts**  Type = gilt brass  brass  iron

other ..... Sample Ret.

**Lid motifs**

other ..... Sample Ret.

**Escutcheons**

other ..... Sample Ret.

**Upholstery nails**

brass  gilt brass  silvered brass  iron  enamelled

other ..... Sample Ret.

**Fixings**

panel nails  screws  hinges  lace  Sample Ret.

**Timber type**

..... Sample Ret.

**Interpretation / Comments**

.....  
.....

SITE		COFFIN RECORD SHEET		CONTEXT NO.	
02/200				1044	
Trench:		Additional sheets: YES X1		Treatment: BONES LIFTED.	
Site sub-div: SC.		Grave fills			
Plan no: 6.		Grave cut:		Finds None ✓	
Section no:		Skeleton: 1042		Breastplate Grip	
Co-ordinates:		Matrix location: 1044 UNDER 1042.		Hinge Bracket	
Levels		Preservation:		Fixing nails Shroud pins	
Slide No.		Neg No:		Fabric Other finds	
<p>Description ADULT BURIAL E-W ORIENTED.          TH INTO BRICK EARTH/CLAYED MAT.          * UPPER PART OF CUT TRUNCATED BY <del>1044</del> 1144 - NOT BODY          W STRUCTURE IS LATER.</p>					
<p>Discussion</p>					
<p>Shape, dimensions and distinguishing characteristics</p> <p>extra bones: 2 tibia          R 1st ME } Adult          1042?</p>					
LID					
HEAD					
BASE					
Recorder: M.		Date: 27.11.00.		Initials:	

Site Code

Context

**Outer Coffin**

Sample Ret.

*BH100*

*104A*

Recording Date ..... *13/2/01* .....

Associated Numbers .....

Condition .....

Dep. Plate

Legible

Inscription

Fabric lead  ormolou  brass  tin plated pewter  gilt tin   
 iron  silvered tin  enamelled  other ..... Sample Ret.

**Shape of dep. plate**

square  rectangle  shield  tapered  lozenge   
 cartouche  oval  other .....

**Upholstery**

colour ..... shoddy  velvet  other ..... Sample Ret.

**Construction**

butt joint  mitred  pitched  other .....

Grip plate  Fabric = ormolou  brass  tin plated pewter  gilt tin   
 iron  silvered tin  enamelled  other ..... Sample Ret.

Grip  Fabric = ormolou  brass  iron  Sample Ret.

Design swag of rose  horseshoe  cherub's head  *(4)* plain   
 other .....

Grip bolts  Corner bolts  Type = gilt brass  brass  iron

other ..... Sample Ret.

Lid motifs  other ..... Sample Ret.

Escutcheons  other ..... Sample Ret.

Upholstery <sup>studs</sup> ~~nails~~  brass  gilt brass  silvered brass  iron  enamelled

other ..... *1 x 000 (gish studs)* ..... Sample Ret.

Fixings  panel nails  screws  hinges  lace  Sample Ret.

Timber type ..... Sample Ret.

**Interpretation / Comments**

.....  
 .....



SITE		COFFIN RECORD SHEET		CONTEXT NO.	
OLR 00				1045	
Trench:		Additional sheets: <i>Western</i>		Treatment:	
Site sub-div: S.E.		Grave fills		BONES LIFTED	
Plan no: 6		Grave cut:		Finds	
Section no:		Skeleton:		None	
Co-ordinates:		Matrix location:		Breastplate <input checked="" type="checkbox"/>	
Levels		Preservation:		Grip	
Slide No.		Neg No:		Hinge	
				Bracket	
				Fixing nails	
				Shroud pins	
				Fabric	
				Other finds	

Description E-W ADULT BURIAL. WOODEN COFFIN.  
 Pb-BREAST PLATE - UNREADABLE - TOO CORRODED.  
 BURIAL MACHINED OUT AS TOO NEAR TO DANGEROUS SECTION.  
 Discussion VERY NEAR (1043), SHOULD BE LOOKED AT TOGETHER AS  
 BOTH MACHINED OUT.

Shape, dimensions and distinguishing characteristics

LID

HEAD

BASE

Recorder: DM	Date: 27/11/00	Initials:
--------------	----------------	-----------

**Outer Coffin**

Sample Ret.

Site Code

Context

Recording Date 22/2/01

**OLR00**

**1045**

Associated Numbers .....

Condition 1

Dep. Plate

Legible  ISH

Inscription "? (Eliz<sup>m</sup> Lindsay?) / Died ? Nov / 1847 / Aged ?"

same as 890.

Fabric lead  ormolou  brass  tin plated pewter  gilt tin   
 iron  silvered tin  enamelled  other ..... Sample Ret.

**Shape of dep. plate**

square  rectangle  shield  tapered  lozenge   
 cartouche  oval  other .....

**Upholstery**

colour ..... shoddy  velvet  other ..... Sample Ret.

**Construction**

butt joint  mitred  pitched  other .....

**Grip plate**

Fabric = ormolou  brass  tin plated pewter  gilt tin   
 iron  silvered tin  enamelled  other ..... Sample Ret.   
*Free on rev of grip-wood*

**Grip**

Fabric = ormolou  brass  iron  <sup>2x</sup> <sub>④</sub> Sample Ret.

**Design**

swag of rose  horseshoe  cherub's head  plain

other .....

**Grip bolts**

**Corner bolts**  Type = gilt brass  brass  iron

other ..... Sample Ret.

**Lid motifs**

other ..... Sample Ret.

**Escutcheons**

other ..... Sample Ret.

**Upholstery nails**

brass  gilt brass  silvered brass  iron  enamelled

other ..... Sample Ret.

**Fixings**

panel nails  screws  hinges  lace  Sample Ret.

**Timber type**

Sample Ret.

**Interpretation / Comments**

.....  
 .....

SITE	COFFIN RECORD SHEET	CONTEXT NO.
OLR 00		1046
Trench:	Additional sheets: 4/85 x 1	Treatment:
Site sub-div: S.R.	Grave fills	Bones LIFTED
Plan no: 6	Grave cut:	Finds
Section no:	Skeleton:	None
Co-ordinates:	Matrix location:	Breastplate <input checked="" type="checkbox"/>
Levels	Preservation:	Grip
Slide No.	Neg No:	Hinge
		Bracket
		Fixing nails
		Shroud pins
		Fabric
		Other finds

Description E-W ADULT BURIAL. WOODEN COFFIN.  
 Pb - BREAST PLATE PRESENT - NOT READABLE IN THE FIELD.  
 (1046) VERY NEAR TO OVERLAP (1045) AND SHOULD BE LOOKED  
 Discussion AT TOGETHER WITH (1045) AND (1043) AS ALL OF THEM  
 WERE MAINLY CUT AS TOO NEAR DANGEROUS SECTION.

Shape, dimensions and distinguishing characteristics

LID

HEAD

BASE

Recorder: DM	Date: 27/11/00	Initials:
--------------	----------------	-----------

# Coffin Recording Sheet

Site Code

Context

**Outer Coffin**

Sample Ret.

OLR00

1046

Recording Date ..... 13/2/01 .....

Associated Numbers .....

Condition ..... 1 .....

Dep. Plate

Legible  NO

Inscription ..... "67 90" .....

*same as 762 w/534 outer border.*

Fabric lead  ormolou  brass  tin plated pewter  gilt tin   
 iron  silvered tin  enamelled  other ..... Sample Ret.

**Shape of dep. plate**

square  rectangle  shield  tapered  lozenge   
 cartouche  oval  other .....

**Upholstery**

colour ..... shoddy  velvet  other ..... Sample Ret.

**Construction**

butt joint  mitred  pitched  other .....

**Grip plate**

Fabric = ormolou  brass  tin plated pewter  gilt tin   
 iron  silvered tin  enamelled  other ..... Sample Ret.   
*frag on rev of grip-wood.*

**Grip**

Fabric = ormolou  brass  iron  x2 Sample Ret.

**Design**

swag of rose  horseshoe  cherub's head  (4)'s plain

other .....

**Grip bolts**

Corner bolts  Type = gilt brass  brass  iron

other ..... Sample Ret.

**Lid motifs**

other ..... Sample Ret.

**Escutcheons**

other ..... Sample Ret.

**Upholstery nails**

brass  gilt brass  silvered brass  iron  enamelled

other ..... Sample Ret.

**Fixings**

panel nails  screws  hinges  lace  Sample Ret.

**Timber type** .....

Sample Ret.

**Interpretation / Comments**

.....  
 .....

SITE	COFFIN RECORD SHEET	CONTEXT NO.
AL100	Additional sheets: 463 x 1.	1047
Trench:	Grave fills	Treatment: BONES LIFTED.
Site sub-div: SC.	Grave cut:	Finds
Plan no: 6	Skeleton:	None ✓
Section no:	Matrix location: OK 1048.	Breastplate
Co-ordinates:	Preservation: good.	Grip ✓
Levels	Neg No:	Hinge
Slide No.	Description	Bracket
EAST-WEST ADULT BURIAL - WOODEN COFFIN.		
CW-ANDY STUWOK. FE GRIP PRESENT.		
VERY CLOSE TO (1048) - POSSIBLE MIXING		
Discussion - SHOULD BE LOOKED AT TOGETHER WITH (1048)		
Shape, dimensions and distinguishing characteristics		
LID		
HEAD		
BASE		
Recorder: Dg.	Date: 28.11.00.	Initials:

# Coffin Recording Sheet

Site Code

Context

**Outer Coffin**

Sample Ret.

OR200

1047

Recording Date ..... 15/12 .....

Associated Numbers .....

Condition .....

Dep. Plate

Legible

Inscription

Fabric lead  ormolou  brass  tin plated pewter  gilt tin   
 iron  silvered tin  enamelled  other ..... Sample Ret.

**Shape of dep. plate**

square  rectangle  shield  tapered  lozenge   
 cartouche  oval  other .....

**Upholstery**

colour ..... shoddy  velvet  other ..... Sample Ret.

**Construction**

butt joint  mitred  pitched  other .....

Grip plate  Fabric = ormolou  brass  tin plated pewter  gilt tin   
 iron  silvered tin  enamelled  other ..... Sample Ret.

Grip  Fabric = ormolou  brass  iron  x2 Sample Ret.

Design swag of rose  horseshoe  cherub's head  (30) plain   
 other .....

Grip bolts  Corner bolts  Type = gilt brass  brass  iron   
 other ..... Sample Ret.

Lid motifs  other ..... Sample Ret.

Escutcheons  other ..... Sample Ret.

Upholstery nails  brass  gilt brass  silvered brass  iron  enamelled   
 other ..... Sample Ret.

Fixings  panel nails  screws  hinges  lace  Sample Ret.

Timber type ..... Sample Ret.

**Interpretation / Comments**

.....  
 .....

26

SITE 02-1800	COFFIN RECORD SHEET	CONTEXT NO. 1048
Trench:	Additional sheets:	Treatment:
Site sub-div: SC	Grave fills	
Plan no: 6.	Grave cut:	Finds None ✓
Section no:	Skeleton:	Breastplate Grip
Co-ordinates:	Matrix location: U/L 1047 O/L 1049	Hinge Bracket
Levels	Preservation:	Fixing nails Shroud pins
Slide No.	Neg No:	Fabric Other finds
<p><b>Description</b> EAST-WEST: ADULT BURIAL. WOODEN COFFIN.          CW-ALLOY STUDWORK,          VERY CLOSE TO (1047) - POSSIBLE MIXING OF BONES  <b>Discussion</b> SHOULD BE LOOKED AT TOGETHER.</p>		
<p><b>Shape, dimensions and distinguishing characteristics</b></p> <p>Extra bones present. Possibly belongs to 1047.          Right M2          left M13          1 scapula          pair of pubic bones (female, stage III, mean 30)</p> <p>LID</p> <p>HEAD</p> <p>BASE</p>		
Recorder: DM	Date: 27-11-00-	Initials:

db

SITE 02200	COFFIN RECORD SHEET	CONTEXT NO. 1049
Trench:	Additional sheets:	Treatment: BONES LIFTED.
Site sub-div: SC	Grave fills	
Plan no: 6.	Grave cut:	Finds None
Section no:	Skeleton:	Breastplate Grip
Co-ordinates:	Matrix location: U/L 1048.	Hinge Bracket
Levels	Preservation:	Fixing nails Shroud pins
Slide No.	Neg No:	Fabric Other finds :
<p>Description EAST-WEST ADULT BURIAL. VERY CLOSE TO (1050) - BONES BAGGED TOGETHER. CW - NOT STUDBACK ON WOODEN COFFIN.</p> <p>Discussion VERY CLOSE TO (1051) AS WELL, SHOULD BE LOOKED AT TOGETHER</p>		
<p>Shape, dimensions and distinguishing characteristics</p> <p>Severe &amp; confusing mixing of 1049, 1050 + clavicles of 1051 and elements of an unnumbered individual.</p> <p>LID Elements consists of</p> <p>pelvis Sacrum &amp; 1-5 T 8-12 Humeri; Left Ulna</p> <p>Adult ♂ 50+</p> <p>HEAD</p> <p>BASE</p>		
Recorder: DM	Date: 27.11.00.	Initials:



26

SITE: 0LP 00	COFFIN RECORD SHEET	CONTEXT NO. 1050
Trench:	Additional sheets:	Treatment: BONES LIFTED
Site sub-div: SR.	Grave fills:	
Plan no: 6	Grave cut:	Findings: None
Section no:	Skeleton:	Breastplate Grip
Co-ordinates:	Matrix location: 1050 J/L 1049	Hinge Bracket
Levels:	Preservation:	Fixing nails Shroud pins
Slide No.:	Neg No.:	Fabric Other finds

**Description:** E-W ADULT BURIAL. VERY CLOSE TO 1049. 1050 AND 1049 WERE BARRIED TOGETHER. VERY CLOSE TO 1049 AND 1051 - SHOULD BE LOOKED AT TOGETHER BECAUSE OF POSSIBLE MIXING.

**Discussion:**

Shape, dimensions and distinguishing characteristics

LID

HEAD

BASE

Recorder: DM	Date: 28/11/00	Initials:
--------------	----------------	-----------

LB

SITE 04E 00	COFFIN RECORD SHEET	CONTEXT NO. 1051
Trench:	Additional sheets:	Treatment: BONES LIFTED
Site sub-div: SE.	Grave fills:	
Plan no: 6	Grave cut:	Findings: None
Section no:	Skeleton:	Breastplate Grip
Co-ordinates:	Matrix location: 1051 U/L 1050	Hinge Bracket
Levels:	Preservation:	Fixing nails Shroud pins
Slide No.:	Neg No.:	Fabric Other finds:

Description E-W ADULT BURIAL. WOODEN COFFIN.  
BURIAL VERY CLOSE TO 1050 AND 1049, POSSIBLE MIXING OF BONES - SHOULD BE LOOKED AT TOGETHER.

Discussion  
Additional bones: R. fibula, distal 1/2 of r. humerus, L & R M3 & left capitulum.

Shape, dimensions and distinguishing characteristics

LID

HEAD

BASE

Recorder: DM	Date: 28/11/00	Initials:
-----------------	-------------------	-----------

SITE		COFFIN RECORD SHEET		CONTEXT NO.	
OLR 00				1052	
Trench:		Additional sheets:		Treatment:	
Site sub-div: S.C.		Grave fills		BONES LIFTED	
Plan no: 6		Grave cut:		Finds	
Section no:		Skeleton:		None	
Co-ordinates:		Matrix location:		Breastplate	
Levels		Preservation:		Grip	
Slide No.		Neg No:		Hinge	
		NEXT TO (1053)		Bracket	
				Fixing nails	
				Shroud pins	
				Fabric	
				Other finds	
<p>Description E-W JUVENILE (YOUNG ADULT) BURIAL, VERY CLOSE TO (1053) VIRTUALLY TOGETHER. BOTH TRUNCATED FROM PEWIS DOWNWARDS, BARGED TOGETHER AS BONES IMPOSSIBLE TO SEPARATE.</p> <p>Discussion</p>					
<p>Shape, dimensions and distinguishing characteristics</p> <p>LID</p> <p>HEAD</p> <p>BASE</p>					
Recorder: DM		Date: 2P/11/00		Initials:	

SITE		COFFIN RECORD SHEET		CONTEXT NO.	
OUR 00				1053	
Trench:		Additional sheets:		Treatment:	
Site sub-div: S.R.		Grave fills		BENCH LIFTED	
Plan no: 6		Grave cut:		Finds	
Section no:		Skeleton:		None	
Co-ordinates:		Matrix location:		Breastplate	
Levels		Preservation:		Grip	
Slide No.		Neg No:		Hinge	
		NEXT to 1052		Bracket	
				Fixing nails	
				Shroud pins	
				Fabric	
				Other finds	
<p>Description E-W JUVENILE (YOUNG ADULT) BURIAL. VERY CLOSE TO 1052 VIRTUALLY TOGETHER. TRUNCATED FROM PERIS DOWNWARDS. 1052 AND 1053 BARRIED TOGETHER AS IMPOSSIBLE TO SEPARATE.</p> <p>Discussion</p>					
Shape, dimensions and distinguishing characteristics					
LID					
HEAD					
BASE					
Recorder: DM		Date: 28/11/00		Initials:	

# Coffin Recording Sheet

Site Code

Context

**Outer Coffin**

Sample Ret.

04200

1053

Recording Date ..... 22/2/01 .....

Associated Numbers .....

Condition .....

Dep. Plate

Legible

Inscription

Fabric lead

ormolou

brass

tin plated pewter

gilt tin

iron

silvered tin

enamelled

other .....

Sample Ret.

**Shape of dep. plate**

square

rectangle

shield

tapered

lozenge

cartouche

oval

other .....

**Upholstery**

colour .....

shoddy

velvet

other .....

Sample Ret.

**Construction**

butt joint

mitred

pitched

other .....

**Grip plate**

Fabric = ormolou

brass

tin plated pewter

gilt tin

iron

silvered tin

enamelled

other .....

Sample Ret.

**Grip**

Fabric = ormolou

brass

iron

1x

Sample Ret.

**Design**

swag of rose

horseshoe

cherub's head

badly on conc.  
2283

plain

other .....

**Grip bolts**

**Corner bolts**

**Type =** gilt brass

brass

iron

other ..... Sample Ret.

**Lid motifs**

other ..... Sample Ret.

**Escutcheons**

other ..... Sample Ret.

**Upholstery nails**

brass

gilt brass

silvered brass

iron

enamelled

other ..... Sample Ret.

**Fixings**

panel nails

screws

hinges

lace

Sample Ret.

**Timber type**

..... Sample Ret.

**Interpretation / Comments**

.....  
.....

SITE	COFFIN RECORD SHEET	CONTEXT NO.
OLR 00	Additional sheets: <i>YES x1.</i>	1054
Trench:	Grave fills	Treatment: <i>BONES LIFTED</i>
Site sub-div: <i>S.E.</i>	Grave cut:	Finds
Plan no: <i>6</i>	Skeleton:	None
Section no:	Matrix location:	Breastplate
Co-ordinates:	Preservation:	Grip <input checked="" type="checkbox"/>
Levels	Neg No:	Hinge
Slide No.	Description	Bracket
	<i>E-W ADULT BURIAL. WOODEN COFFIN. FE GRIPS.</i>	Fixing nails
Discussion		Shroud pins
Shape, dimensions and distinguishing characteristics		Fabric
LID		Other finds
HEAD		
BASE		
Recorder: <i>DM</i>	Date: <i>28/11/00</i>	Initials:

# Coffin Recording Sheet

Site Code

Context

OLR00

1054

**Outer Coffin**

Sample Ret.

Recording Date ..... 21/12/00 .....

Associated Numbers .....

Condition .....

Dep. Plate

Legible

Inscription

**Fabric** lead  ormolou  brass  tin plated pewter  gilt tin   
 iron  silvered tin  enamelled  other ..... Sample Ret.

**Shape of dep. plate**

square  rectangle  shield  tapered  lozenge   
 cartouche  oval  other .....

**Upholstery**

colour ..... shoddy  velvet  other ..... Sample Ret.

**Construction**

butt joint  mitred  pitched  other .....

**Grip plate**  Fabric = ormolou  brass  tin plated pewter  gilt tin   
 iron  silvered tin  enamelled  other ..... Sample Ret.   
*hasgs on rev of grip-wood.*

**Grip**  Fabric = ormolou  brass  iron  *X4* Sample Ret.

**Design** swag of rose  horseshoe  cherub's head  *(A)* plain   
 other .....

**Grip bolts**  **Corner bolts**  **Type =** gilt brass  brass  iron

other ..... Sample Ret.

**Lid motifs**  other ..... Sample Ret.

**Escutcheons**  other ..... Sample Ret.

**Upholstery nails**  brass  gilt brass  silvered brass  iron  enamelled

other ..... Sample Ret.

**Fixings**  panel nails  screws  hinges  lace  Sample Ret.

*ix piece corner-shaped ft.*

**Timber type** ..... Sample Ret.

**Interpretation / Comments**

.....  
 .....

SITE	COFFIN RECORD SHEET		CONTEXT NO.
0260	Additional sheets:	1055	
Trench:	Grave fills	Treatment: BONES.	
Site sub-div: SC	Grave cut:	Finds	
Plan no: 6.	Skeleton:	None	
Section no:	Matrix location:	Breastplate	
Co-ordinates:	0/L 1056	Grip	
Levels	Preservation: GOOD	Hinge	
Slide No.	Neg No:	Bracket	
Description	ADULT EW BURIAL.		
Discussion			
Shape, dimensions and distinguishing characteristics			
LID			
HEAD			
BASE			
Recorder: <i>DM</i>	Date: 28.11.00	Initials:	



SITE <i>02200</i>	COFFIN RECORD SHEET	CONTEXT NO. <i>1056</i>
Trench:	Additional sheets:	Treatment: <i>BONES</i>
Site sub-div: <i>SC</i>	Grave fills	
Plan no: <i>6</i>	Grave cut:	Finds None <input checked="" type="checkbox"/>
Section no:	Skeleton:	Breastplate Grip
Co-ordinates:	Matrix location: <i>U/L 1055</i>	Hinge Bracket
Levels	Preservation: <i>Good</i>	Fixing nails Shroud pins
Slide No.	Neg No:	Fabric Other finds
<p>Description <i>EW ADULT BURIAL -</i></p> <p>Discussion</p>		
<p>Shape, dimensions and distinguishing characteristics</p> <p>LID</p> <p>HEAD</p> <p>BASE</p>		
Recorder: <i>TM</i>	Date: <i>28.11.00</i>	Initials:

SITE		COFFIN RECORD SHEET		CONTEXT NO.	
01200				1057	
Trench:		Additional sheets:		Treatment:	
Site sub-div: SC		Grave fills:		BONES LIFTED DNA NOT TAKEN	
Plan no: 6		Grave cut:		Finds	
Section no:		Skeleton:		None	
Co-ordinates:		Matrix location:		Breastplate ✓ Grip ✓	
Levels:		Preservation:		Hinge	
Slide No.:		Neg No.:		Bracket	
		(1057) v/L (1058)		Fixing nails	
				Shroud pins	
				Fabric	
				Other finds	

**Description** E-W ABOUT SERIAL, WOODEN COFFIN. W-AWAY STUDWORK  
~~OUTER~~ OUTER BREASTPLATE PRESENT.  
 TRUNCATED AT LOWER LEGS DOWNWARDS.

**Discussion**  
 NAMED INDIVIDUAL BUT DNA NOT TAKEN BECAUSE  
 OF INSUFFICIENT SAMPLE MATERIAL.

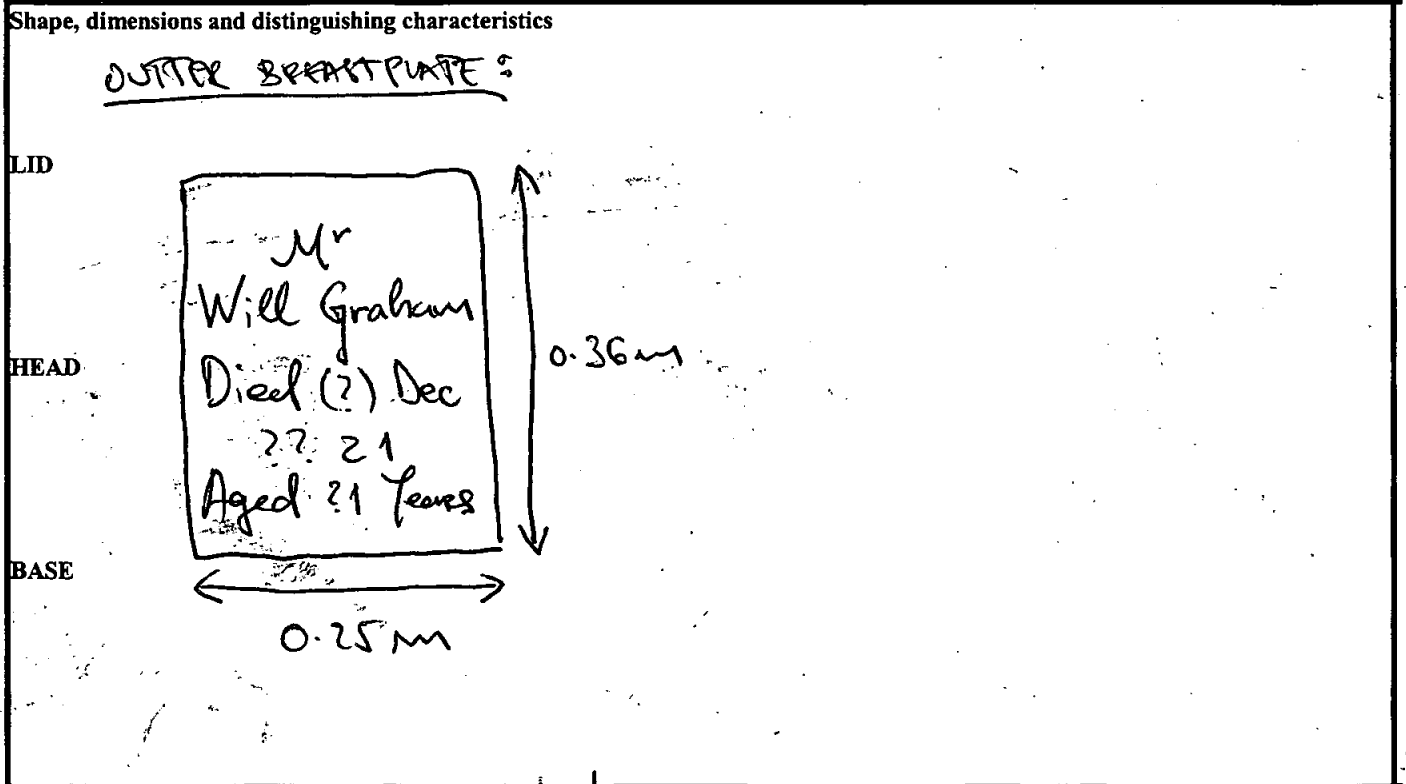

Recorder: DM	Date: 29/11/00	Initials:
--------------	----------------	-----------

Site Code

Context

**Outer Coffin**

Sample Ret.

06200

1057

Recording Date ..... 20/2/01 .....

Associated Numbers .....

Condition ..... 3 .....

Dep. Plate

Legible

Inscription "Mr/Will<sup>m</sup> Gesham/Died? Dec/1821/Aged 51 Years"  
*same as 476 w/ 1144 border plain outer*

Fabric lead  ormolou  brass  tin plated pewter  *gilt tin*  
 iron  silvered tin  enamelled  other ..... Sample Ret.

*block polished*

**Shape of dep. plate**

square  rectangle  shield  tapered  lozenge   
 cartouche  oval  other .....

**Upholstery**

colour ..... shoddy  velvet  other ..... Sample Ret.

**Construction**

butt joint  mitred  pitched  other .....

Grip plate  Fabric = ormolou  brass  tin plated pewter  gilt tin   
 iron  silvered tin  enamelled  other ..... Sample Ret.

Grip  Fabric = ormolou  brass  iron  *x 1* Sample Ret.

Design swag of rose  horseshoe  cherub's head  *too worn to id.* plain   
 other .....

Grip bolts  Corner bolts  Type = gilt brass  brass  iron

other ..... Sample Ret.

Lid motifs  other ..... Sample Ret.

Escutcheons  other ..... Sample Ret.

Upholstery nails  brass  gilt brass  silvered brass  iron  enamelled   
 other ..... Sample Ret.

Fixings  panel nails  screws  hinges  lace  Sample Ret.

Timber type ..... Sample Ret.

**Interpretation / Comments**

.....  
 .....

23

SITE <u>AR 00</u>		COFFIN RECORD SHEET	CONTEXT NO. <u>1058</u>
Trench:	Additional sheets: <u>NES K1</u>	Treatment: <u>BONES LIFTED</u>	
Site sub-div: <u>S.C.</u>	Grave fills		
Plan no: <u>6</u>	Grave cut:	Finds None	
Section no:	Skeleton:	Breastplate Grip	
Co-ordinates:	Matrix location: <u>(1058) o/L (1057)</u>	Hinge Bracket	
Levels	Preservation:	Fixing nails Shroud pins	
Slide No.	Neg No:	Fabric Other finds	

Description E-W JUVENILE BURIAL. WOODEN COFFIN.  
CW ANCHOR SNOWWORK. TRUNCATED FROM PELVIS AREA  
DOWNWARDS.

Discussion

Shape, dimensions and distinguishing characteristics

LID

HEAD

BASE

Recorder: <u>DM</u>	Date: <u>29/11/00</u>	Initials:
---------------------	-----------------------	-----------

**Outer Coffin**

Sample Ret.

Site Code

Context

62200

1058

Recording Date ..... 6/12/00 .....

Associated Numbers .....

Condition .....

Dep. Plate

Legible

Inscription

Fabric lead  ormolou  brass  tin plated pewter  gilt tin   
 iron  silvered tin  enamelled  other ..... Sample Ret.

**Shape of dep. plate**

square  rectangle  shield  tapered  lozenge   
 cartouche  oval  other .....

**Upholstery**

colour ..... shoddy  velvet  other ..... Sample Ret.

**Construction**

butt joint  mitred  pitched  other .....

**Grip plate**  Fabric = ormolou  brass  tin plated pewter  gilt tin   
*Fragon rev of grip + unid*  
 iron  silvered tin  enamelled  other ..... Sample Ret.

**Grip**  Fabric = ormolou  brass  iron  Sample Ret.

**Design** swag of rose  horseshoe  cherub's head  plain   
 other ..... *too conc. to id.*

**Grip bolts**  **Corner bolts**  **Type =** gilt brass  brass  iron   
 other ..... Sample Ret.

**Lid motifs**  other ..... Sample Ret.

**Escutcheons**  other ..... Sample Ret.

**Upholstery nails**  brass  gilt brass  silvered brass  iron  enamelled   
 other ..... Sample Ret.

**Fixings**  panel nails  screws  hinges  lace  Sample Ret.

**Timber type** ..... Sample Ret.

**Interpretation / Comments**

.....  
 .....

SITE	COFFIN RECORD SHEET	CONTEXT NO.
02200		1060
Trench:	Additional sheets:	Treatment: INTACT
Site sub-div: CRYPT	Grave fills	INFANT ⇒ NECROP.
Plan no: 7	Grave cut:	Finds
Section no:	Skeleton:	None
Co-ordinates:	Matrix location: in Box 3	Breastplate Inscript. Rect ⊙
Levels	Preservation:	Hinge
Slide No.	Neg No:	Bracket
		Fixing nails
		Shroud pins
		Fabric
		Other finds

Description infant p.b coffin, S → N

Discussion

Shape, dimensions and distinguishing characteristics

LID

HEAD

BASE

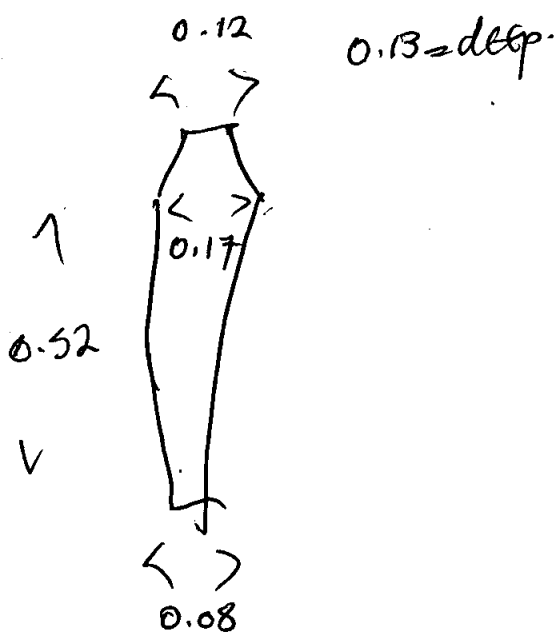

"Miss Jone  
Matheson  
Born 13<sup>th</sup> Nov<sup>r</sup>  
1824  
Died 18<sup>th</sup> Nov<sup>r</sup>  
1824

Recorder: MEI

Date: 22/11

Initials:

SITE	COFFIN RECORD SHEET	CONTEXT NO.
02200		1061
Trench:	Additional sheets:	Treatment: INTACT →
Site sub-div: CRYPT	Grave fills	NECROP SUBADULT.
Plan no: 7	Grave cut:	Finds None
Section no:	Skeleton:	Breastplate in script. (top) Grip
Co-ordinates:	Matrix location:	Hinge Bracket
Levels	Preservation:	Fixing nails Shroud pins
Slide No.	Neg No:	Fabric Other finds

Description sub adult p.o. coffin, S → N,

Discussion

Shape, dimensions and distinguishing characteristics

LID

HEAD

BASE

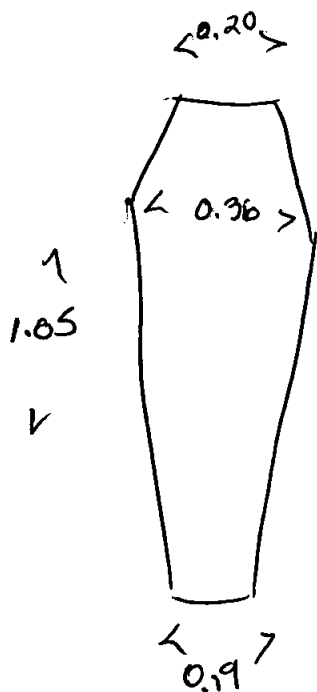

0.27 = depth

⊙  
"Master  
Fred<sup>ck</sup> Matteson  
Died 27<sup>th</sup> Oct<sup>r</sup>  
1838  
Aged 5 years"

Recorder: MEI

Date: 22/11

Initials:

SITE <i>02R00</i>		COFFIN RECORD SHEET	CONTEXT NO. <i>1062</i>
Trench:	Additional sheets:	Treatment: <i>DNA TAKEN &amp; BONES LIFTED.</i>	
Site sub-div: <i>CRYPT</i>	Grave fills:		
Plan no: <i>7</i>	Grave cut:	Finds None	
Section no:	Skeleton:	Breastplate <i>inscript disturbed.</i> Grip	
Co-ordinates:	Matrix location: <i>in Bay 3 of 1063</i>	Hinge Bracket	
Levels:	Preservation: <i>1</i>	Fixing nails Shroud pins	
Slide No. <i>1</i>	Neg No: <i>1</i>	Fabric Other finds	

Description

*adult pb coffin, W → E*

Discussion

Shape, dimensions and distinguishing characteristics

LID

*< 0.33 >*  
*0.24 = deep.*

*" Mr  
Richard Sumption  
Died 29<sup>th</sup> January  
1824  
in his 63<sup>rd</sup> year "*

HEAD

*9  
1.82*



BASE

*V*

*< 0.20 >*

Recorder: *ME*

Date: *22/11*

Initials:



SITE	COFFIN RECORD SHEET	CONTEXT NO.
02A00		1063
Trench:	Additional sheets:	Treatment: NO NAME INTACT ⇒ NECROP.
Site sub-div: CRYPT	Grave fills	
Plan no: 7	Grave cut:	Finds None
Section no:	Skeleton:	Breastplate Grip
Co-ordinates:	Matrix location: in box 3 u/l 1062	Hinge Bracket
Levels	Preservation: 4	Fixing nails Shroud pins
Slide No.	Neg No:	Fabric Other finds

Description: Adult p.b coffin, N → E; no name; plate gone before spoil dumped.

Discussion

Shape, dimensions and distinguishing characteristics

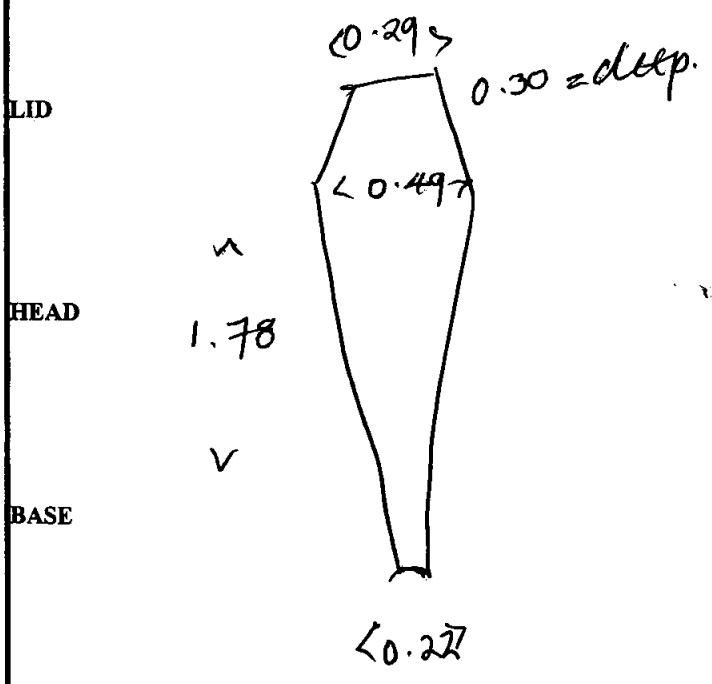

Recorder: MH	Date: 22/11	Initials:
--------------	-------------	-----------

SITE <b>ORR06</b>	COFFIN RECORD SHEET	CONTEXT NO. <b>106A</b>
Trench:	Additional sheets:	Treatment: <b>INTACT ⇒ NECROP.</b>
Site sub-div: <b>CRYPT</b>	Grave fills:	
Plan no: <b>7</b>	Grave cut:	Finds None
Section no:	Skeleton:	Breastplate Grip
Co-ordinates:	Matrix location: <b>in Bay 3 o/l 1065</b>	Hinge Bracket
Levels:	Preservation: <b>A</b>	Fixing nails Shroud pins
Slide No.:	Neg No.:	Fabric Other finds

**Description** **adult pb coffin, E → W, NO NAME.**

**Discussion**

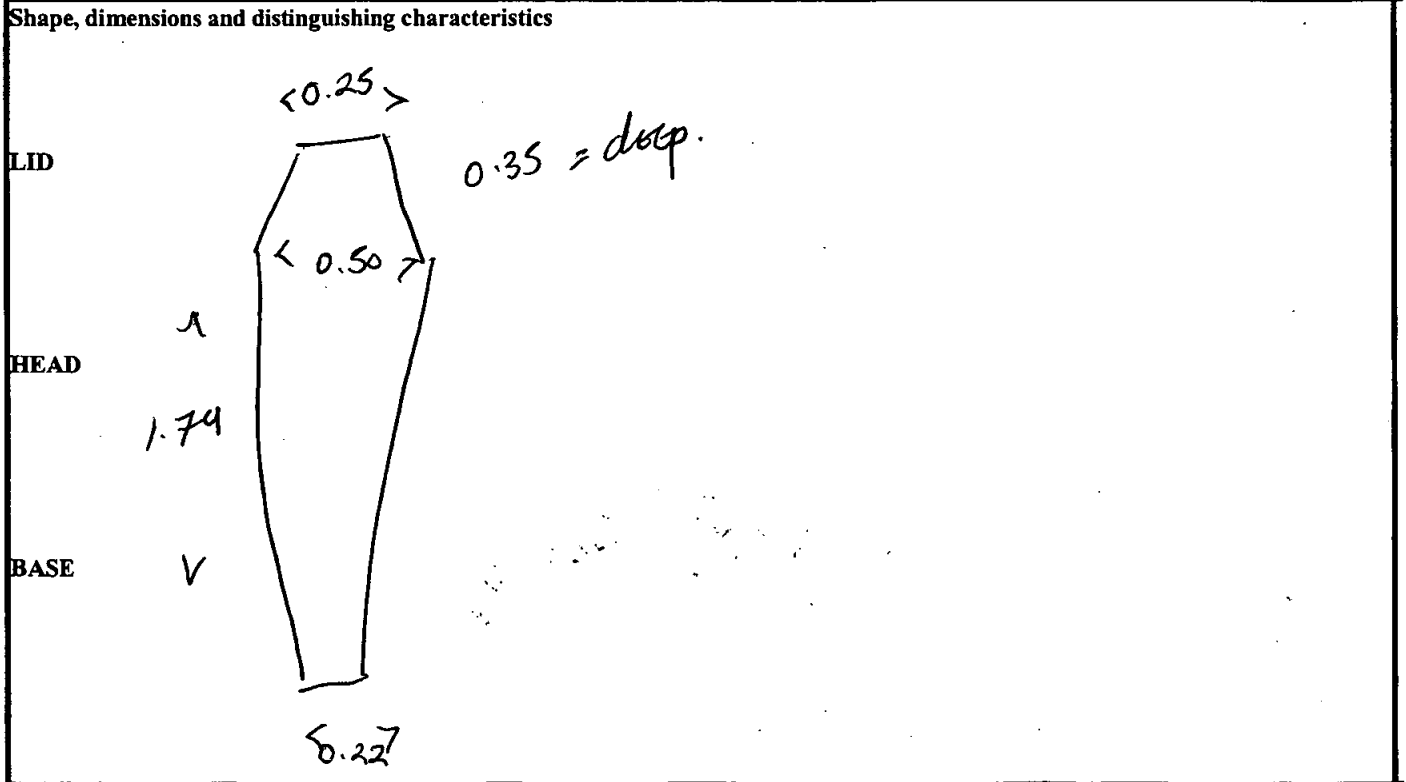

Recorder: <b>Mel</b>	Date: <b>22/11</b>	Initials:
----------------------	--------------------	-----------

SITE	COFFIN RECORD SHEET	CONTEXT NO.
ORR00		1065
Trench:	Additional sheets:	Treatment: <del>INTERIOR BONES</del>
Site sub-div: <i>CRYPT</i>	Grave fills	LIFTED <del>INTERIOR</del> DNA TAKEN
Plan no: <i>7</i>	Grave cut:	Finds None
Section no:	Skeleton:	Breastplate <i>inscript - dia on 2 bord.</i> Grip
Co-ordinates:	Matrix location: <i>in Bay 3</i> <i>u/l 1064</i>	Hinge Bracket
Levels	Preservation:	Fixing nails Shroud pins
Slide No.	Neg No:	Fabric Other finds

Description *adult p.b. coffin, E → W,*

Discussion

Shape, dimensions and distinguishing characteristics

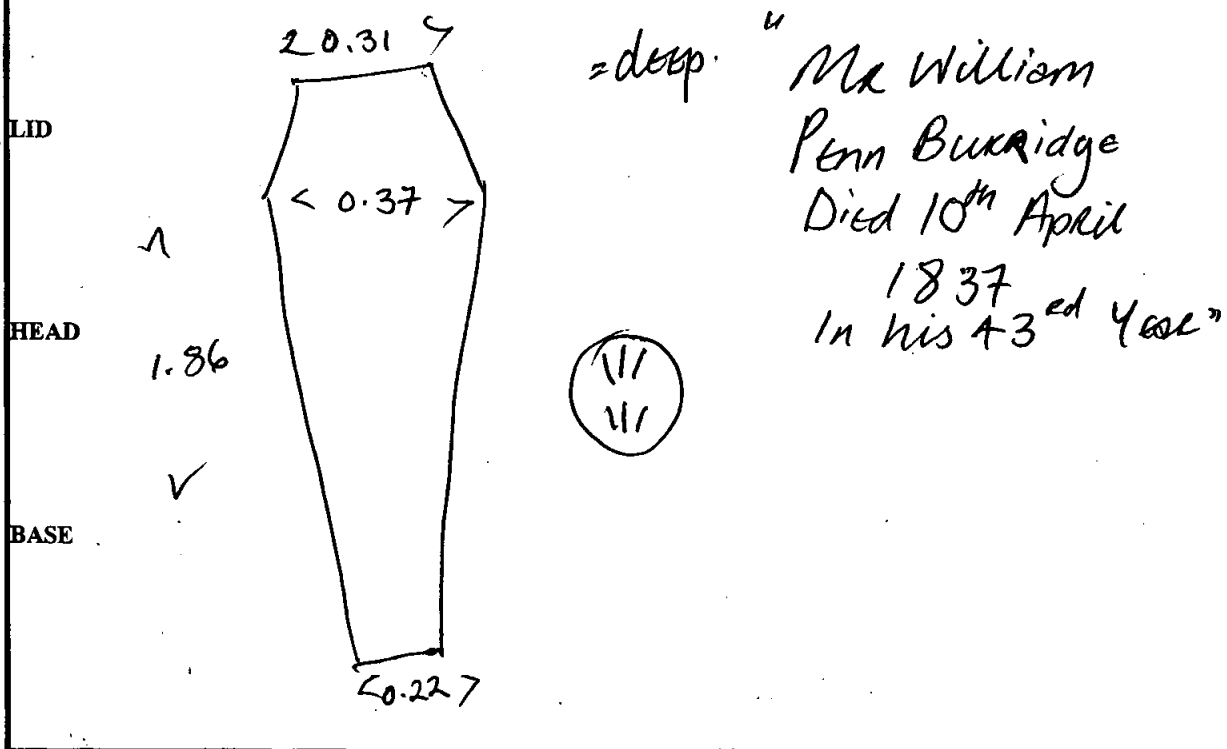

Recorder: <i>Mei</i>	Date: <i>22/11</i>	Initials:
----------------------	--------------------	-----------

SITE <i>OLR00</i>		COFFIN RECORD SHEET	CONTEXT NO. <i>1066</i>
Trench:	Additional sheets: <i>YES X 2</i>	Treatment: <i>INTACT</i> <i>⇒ NECROP.</i>	
Site sub-div: <i>CRYPT</i>	Grave fills	Finds	
Plan no: <i>7</i>	Grave cut:	None	
Section no:	Skeleton:	Breastplate <i>✓ @ cu alloy.</i>	
Co-ordinates:	Matrix location: <i>in Bay 4</i>	Grip <i>x 2 cu @ 15</i> <i>&amp; heavy g. plate</i>	
Levels	Preservation:	Hinge	
Slide No.	Neg No:	Bracket	
		Fixing nails <i>up studs cu alloy.</i>	
		Shroud pins	
		Fabric	
		Other finds <i>6 sections x 20mm</i>	

Description *adult pb coffin E → W* *- 2 sizes.*

Discussion

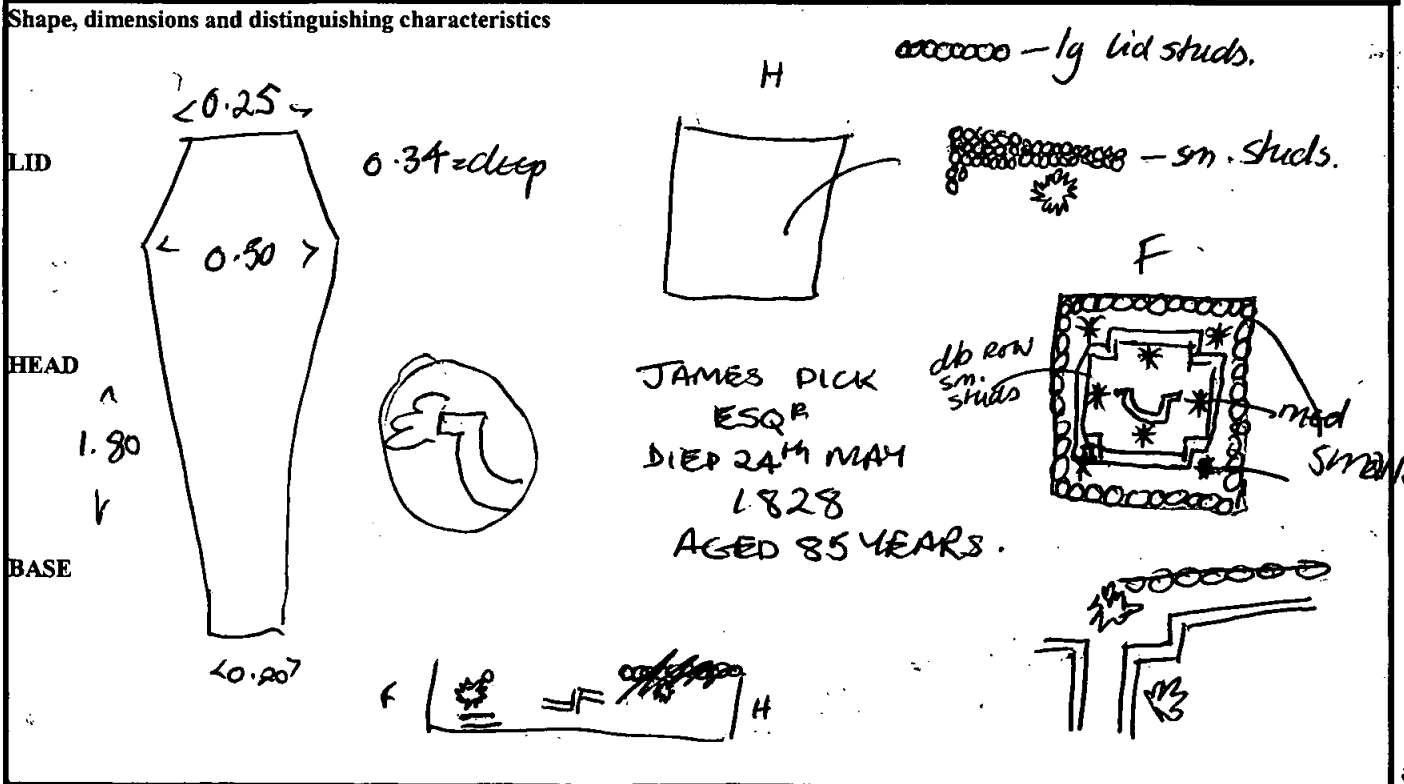

Recorder: *Mel*      Date: *23/11*      Initials:

Site Code

Context

**Outer Coffin**

Sample Ret.

OR100

1066

Recording Date ..... 24/11 .....

Associated Numbers .....

Condition ..... 3 .....

Dep. Plate

Legible

Inscription "JAMES DICK/ESQR/DIED 24<sup>th</sup> MAY/1828/AGED 85 YEARS"

Fabric lead  ormolou  brass  <sup>(20)</sup> tin plated pewter  gilt tin   
 iron  silvered tin  enamelled  other ..... Sample Ret.

**Shape of dep. plate**

square  rectangle  shield  tapered  lozenge   
 cartouche  oval  other .....

**Upholstery**

colour ..... shoddy  velvet  other *BOULE* ..... Sample Ret.

**Construction** butt joint  mitred  pitched  other .....

**Grip plate**  <sup>ish.</sup> Fabric = ormolou  brass  tin plated pewter  gilt tin   
 iron  silvered tin  enamelled  other *SEE NEXT SHEET* ..... Sample Ret.

**Grip**  Fabric = ormolou  brass  iron  Sample Ret.

**Design** swag of rose  horseshoe  cherub's head  <sup>(A)</sup> x2 plain   
 other .....

**Grip bolts**  **Corner bolts**  Type = gilt brass  brass  iron   
 other ..... Sample Ret.

**Lid motifs**  other ..... Sample Ret.

**Escutcheons**  other *1 x lg = 0.055 / 1 x sm = 0.003 - (6) 75* ..... <sup>SEE PREVIOUS SHEET FOR INSITU POSITIONS</sup> Sample Ret.

**Upholstery nails**  brass  gilt brass  silvered brass  iron  enamelled   
 other *many - not matched to Spfds.* ..... Sample Ret.

**Fixings**  panel nails  screws  hinges  lace  Sample Ret.

**Timber type** ..... Sample Ret.

**Interpretation / Comments**

.....  
 .....

Scale. 1:1.



Scale 1:1.



Scales 1:1.



Scale 1:1.



do seen  
in situ  
- more like a  
rasette style  
rather than gill  
plate. No match  
for spitel fields.

SITE <i>ORR00</i>		COFFIN RECORD SHEET	CONTEXT NO. <i>1067</i>
Trench:	Additional sheets:	Treatment: <del>DNA</del> <i>DNA - <del>TESTED</del></i> <i>TAKEN, BONES LIFTED</i>	
Site sub-div: <i>CRYPT</i>	Grave fills:		
Plan no: <i>7</i>	Grave cut:	Finds None	
Section no:	Skeleton:	Breastplate <i>maxiplex</i> Grip <i>wooden x 2 @ 1's</i>	
Co-ordinates:	Matrix location: <i>m Box A</i>	Hinge <i>Fe plate (ch needs)</i> Bracket	
Levels:	Preservation:	Fixing nails Shroud pins	
Slide No.:	Neg No.:	Fabric <i>studs - x 3 Fe.</i> Other finds	

**Description** *adult pb coffin W → E, broken in coffin, remains in v: poor condition.*

**Discussion**

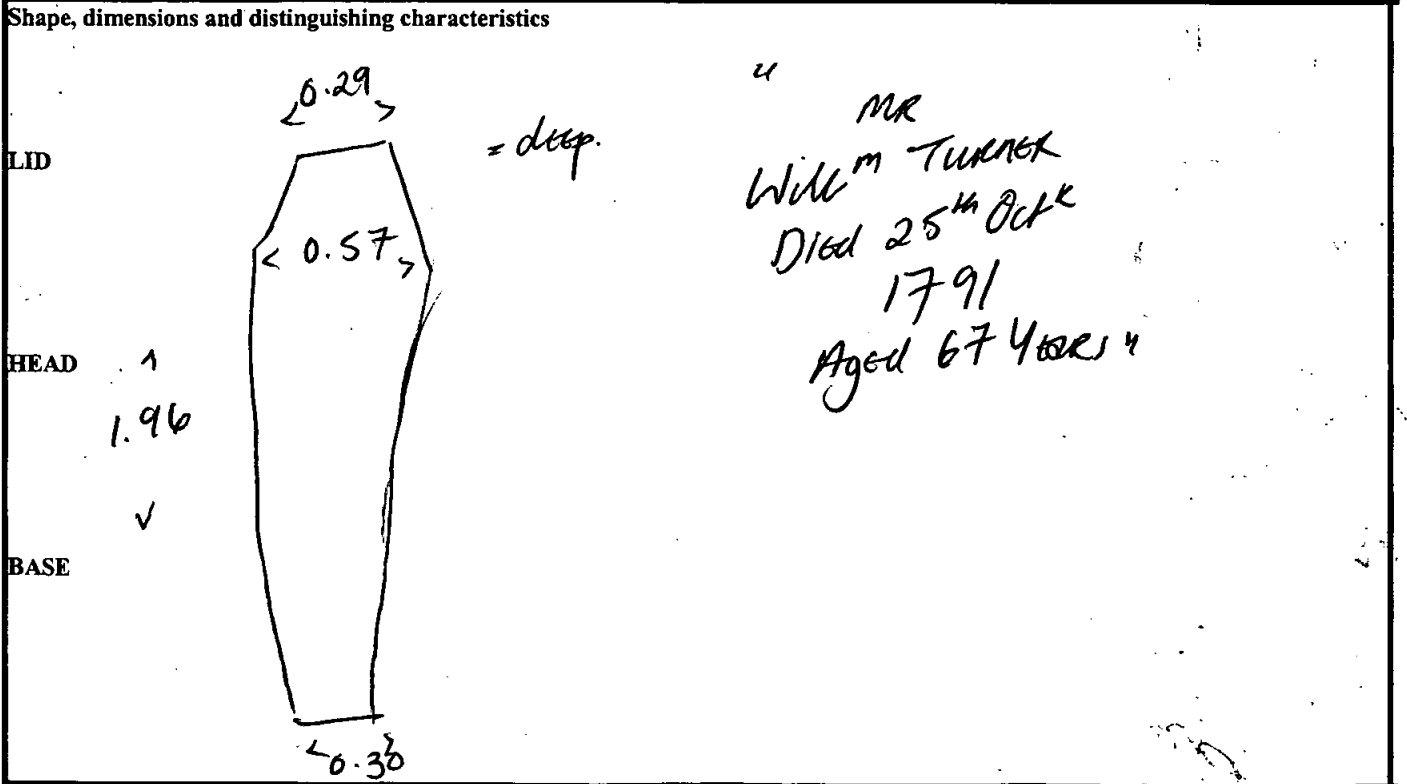

Recorder: *Mel* Date: *23/11* Initials:

SITE <u>02R00</u>		COFFIN RECORD SHEET	CONTEXT NO. <u>1068</u>
Trench:	Additional sheets: <u>YES x1.</u>	Treatment: <u>BONES LIFTED. DNA TAKEN.</u>	
Site sub-div: <u>CAMPT</u>	Grave fills		
Plan no: <u>7</u>	Grave cut:	Finds	
Section no:	Skeleton:	None <u>dep plate (top) (b)</u> Breastplate <u>inscript. Rct: (c)</u> Grip <u>1/2 (A) x 1 (B)</u>	
Co-ordinates:	Matrix location: <u>in Box A</u>	Hinge	
Levels	Preservation:	Bracket	
Slide No.	Neg No:	Fixing nails	
		Shroud pins	
		Fabric <u>studs - 1/2 x 3.</u>	
		Other finds	

Description adult pb coffin, E → W, beam in coffin.

Discussion

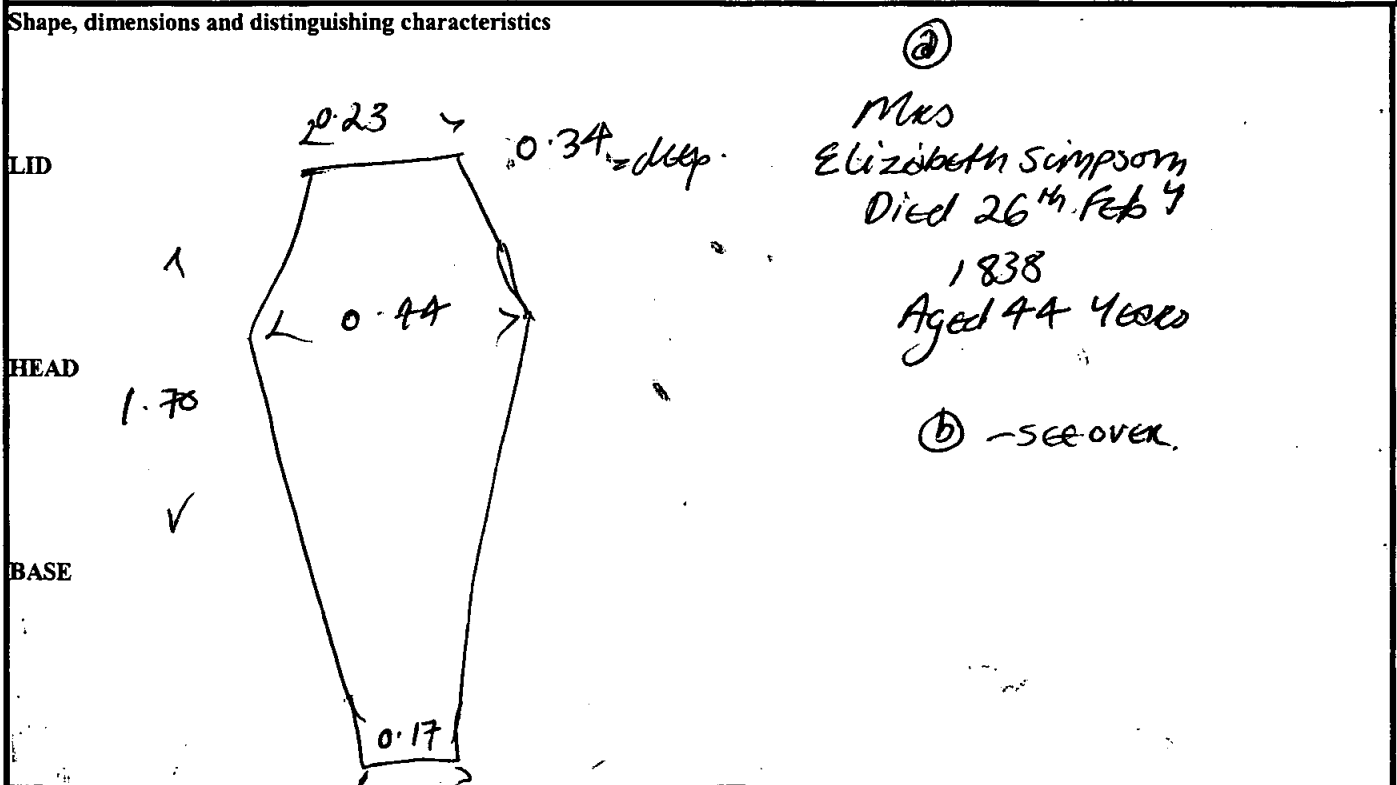

Recorder: <u>MEL</u>	Date: <u>23/11</u>	Initials:
----------------------	--------------------	-----------



Site Code

Context

Outer Coffin

Sample Ret.

OLR00

1068

Recording Date ..... 24/11 .....

Associated Numbers .....

Condition ..... 3 .....

Dep. Plate

Legible

Inscription *Mrs Eliz<sup>th</sup>/Simpson/Died 26<sup>th</sup> Feb<sup>y</sup>/1838/Aged 44.  
Some so 776 w/ 618 inner & outer border.*

Fabric lead  ormolou  brass  tin plated pewter  gilt tin   
iron  silvered tin  enamelled  other ..... Sample Ret.

*black polished.*

Shape of dep. plate

square  rectangle  shield  tapered  lozenge   
cartouche  oval  other .....

Upholstery

colour ..... shoddy  velvet  other ..... Sample Ret.

Construction

butt joint  mitred  pitched  other .....

Grip plate  Fabric = ormolou  brass  tin plated pewter  gilt tin   
iron  silvered tin  enamelled  other ..... Sample Ret.

Grip  Fabric = ormolou  brass  iron  Sample Ret.

Design swag of rose  horseshoe  cherub's head  *x 1*  plain   
other .....

Grip bolts  Corner bolts  Type = gilt brass  brass  iron   
other ..... Sample Ret.

Lid motifs  other ..... Sample Ret.

Escutcheons  other ..... Sample Ret.

Upholstery ~~rusts~~ *studs*  brass  gilt brass  silvered brass  iron  enamelled   
other ..... *x 3 studs in total* ..... Sample Ret.

Fixings  panel nails  screws  hinges  lace  Sample Ret.

Timber type ..... Sample Ret.

Interpretation / Comments

.....  
.....

SITE <i>02200</i>		COFFIN RECORD SHEET	CONTEXT NO. <i>1069</i>
Trench:	Additional sheets: <i>YES x 2</i>	Treatment: <i>DNA TAKEN</i> <i>✓ BONES LIFTED.</i>	
Site sub-div: <i>CRYPT</i>	Grave fills		
Plan no: <i>7</i>	Grave cut:	Finds None	
Section no:	Skeleton:	Breastplate <i>✓ (top) (b)</i> <i>incised dir (c)</i> Grip <i>x 2 Fe - <del>wood</del> (d)</i>	
Co-ordinates:	Matrix location: <i>in Bay 4</i> <i>of L 1072</i>	Hinge Bracket	
Levels	Preservation:	Fixing nails Shroud pins	
Slide No.	Neg No.:	Fabric Other finds	

Description *adult pb. coffin, W→E, beam in coffin,*

Discussion

Shape, dimensions and distinguishing characteristics

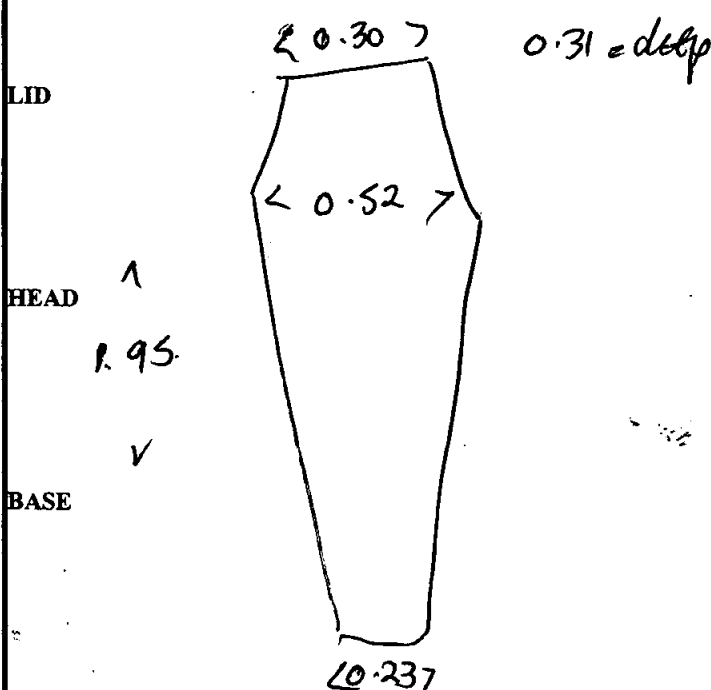

*Ann Nightingale*  
*Died 14<sup>th</sup> Feb 9*  
*1842*  
*in her 49<sup>th</sup> years"*  
 SET OVER.

Recorder: <i>Mel</i>	Date: <i>23/11</i>	Initials:
----------------------	--------------------	-----------

# Coffin Recording Sheet

Site Code

Context

**Outer Coffin**

Sample Ret.

*NR00*

*1069*

Recording Date ..... *24th* .....

Associated Numbers .....

Condition ..... *3* .....

Dep. Plate

*Feb 4* legible

Inscription *"M<sup>rs</sup> Ann Nightingale / Died 14<sup>th</sup> April / 1848 / In her 49<sup>th</sup> Y<sup>r</sup>"*

Fabric lead  ormolou  brass  tin plated pewter  gilt tin   
 iron  silvered tin  enamelled  other ..... Sample Ret.

**Shape of dep. plate**

square  rectangle  shield  tapered  lozenge   
 cartouche  oval  other .....

**Upholstery**

colour ..... shoddy  velvet  other *Boots on REV of dep. plate.* Sample Ret.

Construction butt joint  mitred  pitched  other .....

Grip plate  Fabric = ormolou  brass  tin plated pewter  gilt tin   
 iron  silvered tin  enamelled  other ..... Sample Ret.

Grip  Fabric = ormolou  brass  iron  Sample Ret.

Design swag of rose  horseshoe  cherub's head  plain   
 other .....

Grip bolts  Corner bolts  Type = gilt brass  brass  iron   
 other ..... Sample Ret.

Lid motifs  other ..... Sample Ret.

Escutcheons  other ..... Sample Ret.

Upholstery nails  brass  gilt brass  silvered brass  iron  enamelled   
 other ..... Sample Ret.

Fixings  panel nails  screws  hinges  lace  Sample Ret.

Timber type ..... Sample Ret.

**Interpretation / Comments**

.....  
 .....

SITE	COFFIN RECORD SHEET	CONTEXT NO.
02100		1070
Trench:	Additional sheets:	Treatment: BONES LIFTED
Site sub-div: CRYPT	Grave fills	NONAME, NO DNA
Plan no: 7	Grave cut:	Finds
		None
Section no:	Skeleton:	Breastplate inscript. rect Grip
Co-ordinates:	Matrix location: in Bay 4 d-977	Hinge
Levels	Preservation: 1	Bracket
Slide No.	Neg No:	Fixing nails
		Shroud pins
		Fabric
		Other finds

**Description**  
 sub-adult p.b. coffin, W → E, coffin badly crushed & damaged, bren in coffin → bones in poor cond.

**Discussion**

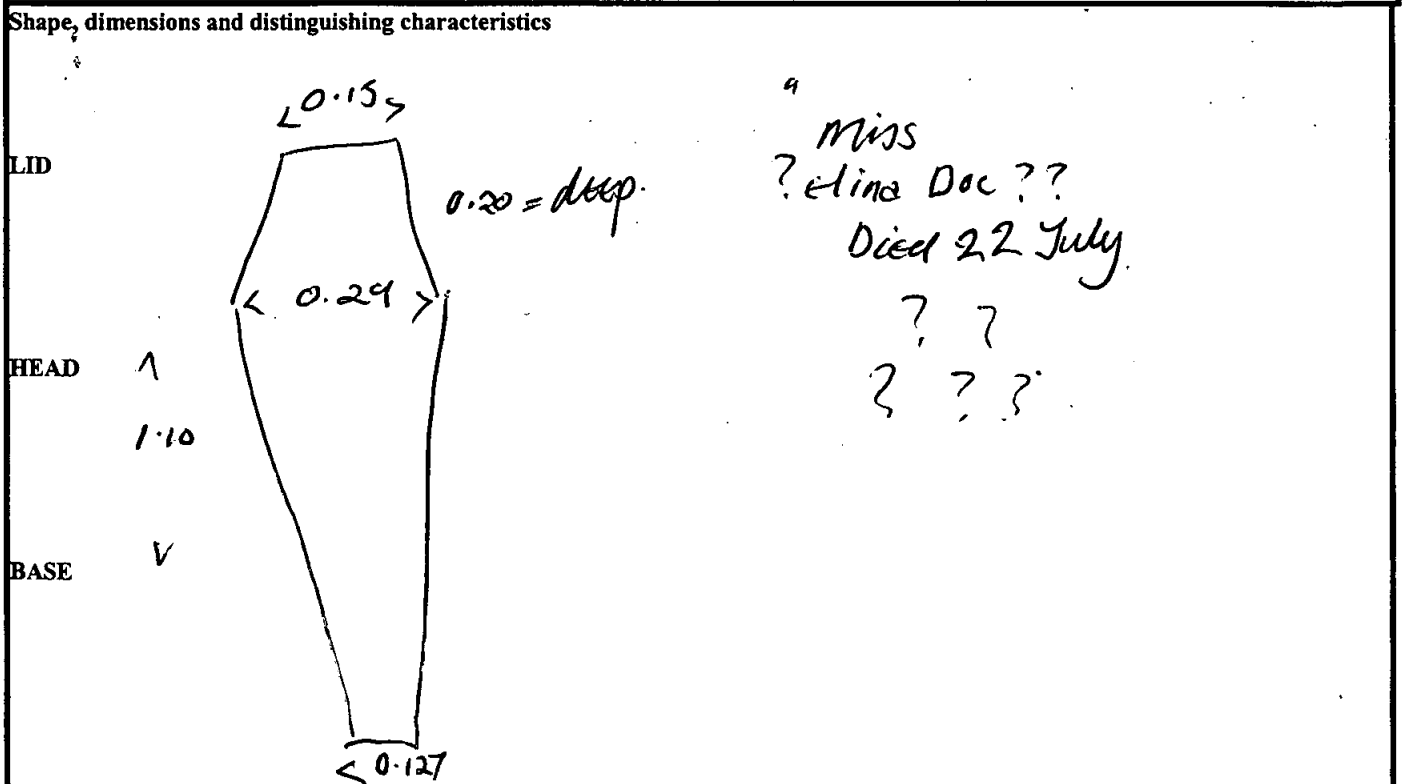

Recorder: Mel Date: 23/4 Initials:

SITE	COFFIN RECORD SHEET	CONTEXT NO.
FLR00		1071
Trench:	Additional sheets:	Treatment: DNA TAKEN BONES LIFTED
Site sub-div: CRYOT	Grave fills	
Plan no: 7	Grave cut:	Finds
Section no:	Skeleton:	None <del>inscript</del> Breastplate ✓ Grip V x 3 <del>unid</del> unid (12P) (84)
Co-ordinates:	Matrix location: in bay 4 adj to 1073	Hinge Bracket
Levels	Preservation: 1	Fixing nails Shroud pins
Slide No.	Neg No:	Fabric studs x 5 (Fe-) Other finds

**Description** ~~small~~ adult p.b. coffin, beam in coffin. E → W

**Discussion**

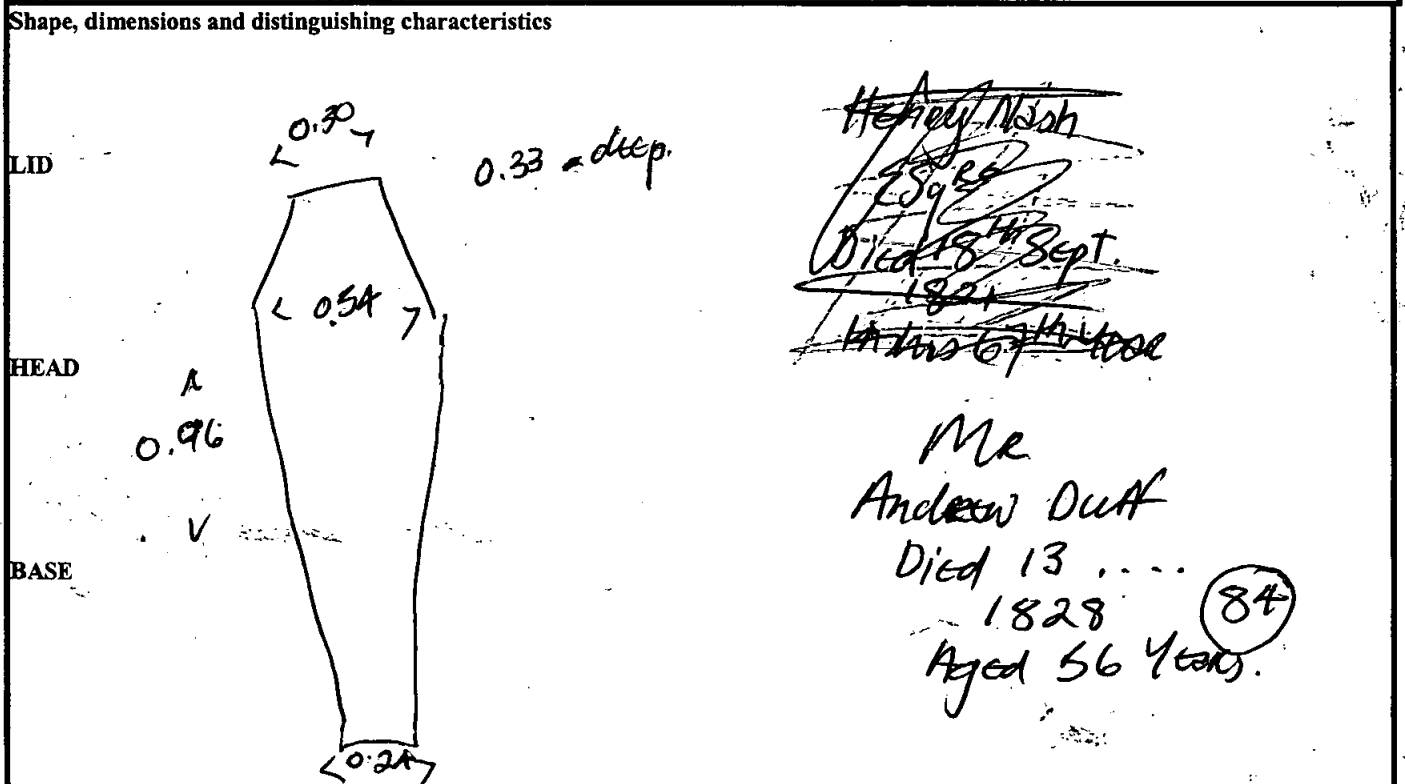

Recorder: Mel	Date: 23/11	Initials:
---------------	-------------	-----------

# Coffin Recording Sheet

Site Code

Context

**Outer Coffin**

Sample Ret.

0200

1071

Recording Date ..... 19/2/01

Associated Numbers .....

Condition .....

Dep. Plate

Legible

Inscription

Fabric lead  ormolou  brass  tin plated pewter  gilt tin   
 iron  silvered tin  enamelled  other ..... Sample Ret.

**Shape of dep. plate**

square  rectangle  shield  tapered  lozenge   
 cartouche  oval  other .....

**Upholstery**

colour ..... shoddy  velvet  other ..... Sample Ret.

**Construction**

butt joint  mitred  pitched  other .....

Grip plate  Fabric = ormolou  brass  tin plated pewter  gilt tin   
 iron  silvered tin  enamelled  other ..... Sample Ret.

Grip  Fabric = ormolou  brass  iron  Sample Ret.

Design swag of rose  horseshoe  cherub's head  plain   
 other .....

Grip bolts  Corner bolts  Type = gilt brass  brass  iron   
 other ..... Sample Ret.

Lid motifs  other .....

Escutcheons  other .....

Upholstery <sup>studs</sup> nails  brass  gilt brass  silvered brass  iron  enamelled   
 other ..... Sample Ret.

Fixings  panel nails  screws  hinges  lace  Sample Ret.

Timber type ..... Sample Ret.

**Interpretation / Comments**

.....  
 .....

SITE <i>OLR00</i>	COFFIN RECORD SHEET	CONTEXT NO. <i>1072</i>
Trench:	Additional sheets: <i>YES x 2</i>	Treatment: <i>BONES LIFTED, NO DNA, TOO FRAGILE.</i>
Site sub-div. <i>CRYPT</i>	Grave fills	
Plan no:	Grave cut:	Finds None <i>inscript dir.</i>
Section no:	Skeleton:	Breastplate Grip <input checked="" type="checkbox"/> <i>+ plate (P) x 2</i>
Co-ordinates:	Matrix location: <i>Box 4</i> <i>U/L 1069</i>	Hinge Bracket
Levels	Preservation:	Fixing nails Shroud pins
Slide No.	Neg No:	Fabric Other finds

Description *infant p.b. coffin, bones in poor cond.*

Discussion

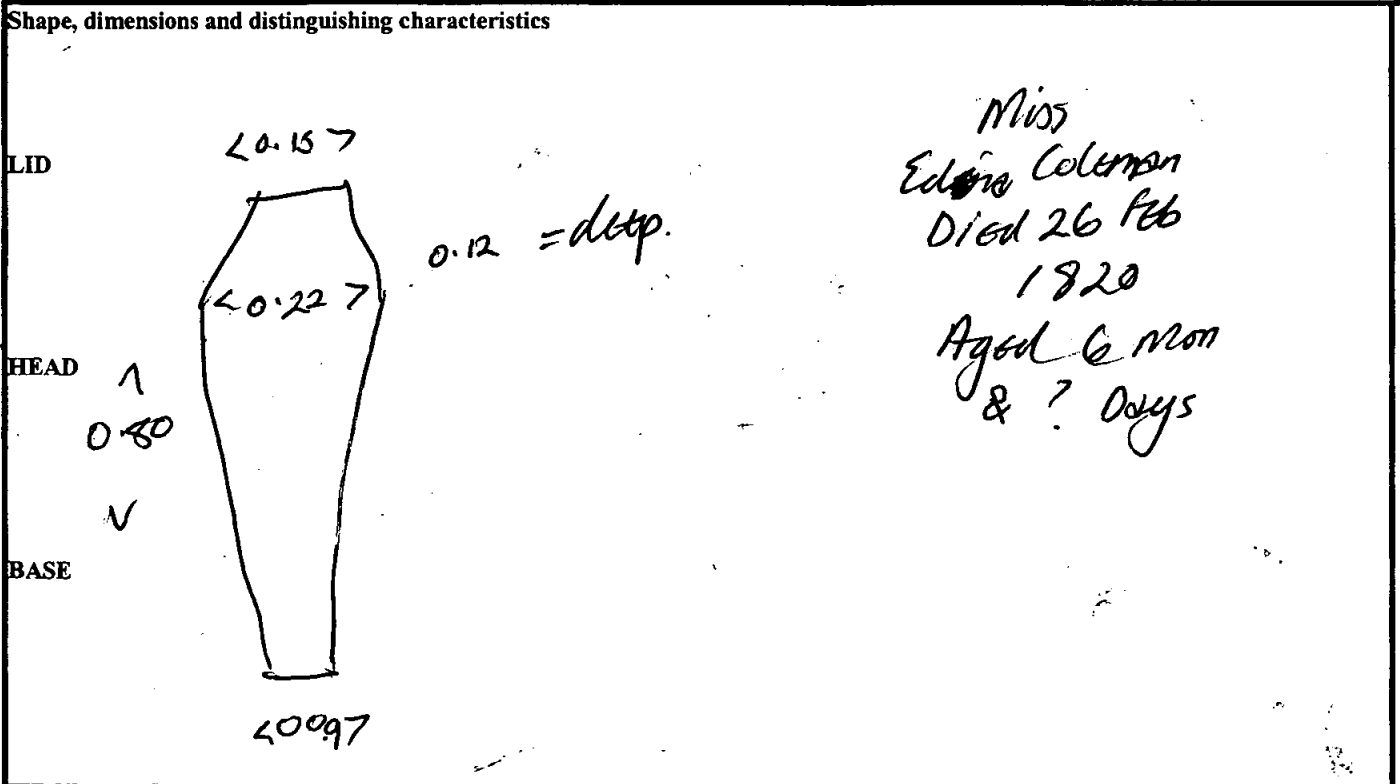

Recorder: <i>Mel</i>	Date: <i>23/11</i>	Initials:
----------------------	--------------------	-----------

**Outer Coffin**

Sample Ret.

Site Code

Context

Recording Date ..... *24/11* .....

*OLR00*

*1072*

Associated Numbers .....

Condition .....

Dep. Plate

Legible

Inscription

Fabric lead  ormolou  brass  tin plated pewter  gilt tin   
 iron  silvered tin  enamelled  other ..... Sample Ret.

**Shape of dep. plate**

square  rectangle  shield  tapered  lozenge   
 cartouche  oval  other .....

**Upholstery**

colour ..... shoddy  velvet  other ..... Sample Ret.

**Construction**

butt joint  mitred  pitched  other .....

Grip plate  Fabric = ormolou  brass  tin plated pewter  gilt tin   
 iron  silvered tin  enamelled  other ..... Sample Ret.

*small cartouche on rev of grip + other decorative details.*

Grip  Fabric = ormolou  brass  iron  *x3 infant.* Sample Ret.

**Design**

swag of rose  horseshoe  cherub's head  plain

*↔ 0.08 ↑ 0.03*

other .....

Grip bolts  Corner bolts  Type = gilt brass  brass  iron

other ..... Sample Ret.

Lid motifs *? x1*  other *fe db chevrons felt - too big to be part of grip plate* Sample Ret.

Escutcheons  other ..... Sample Ret.

Upholstery *studs*  brass  gilt brass  silvered brass  iron  *small* enamelled

other ..... *3 x 00 / 1 x 000 / 6 x 0 = 15 studs.* Sample Ret.

Fixings  panel nails  screws  hinges  lace  Sample Ret.

Timber type ..... Sample Ret.

**Interpretation / Comments**

.....  
 .....



OKR00

1072

(cont)

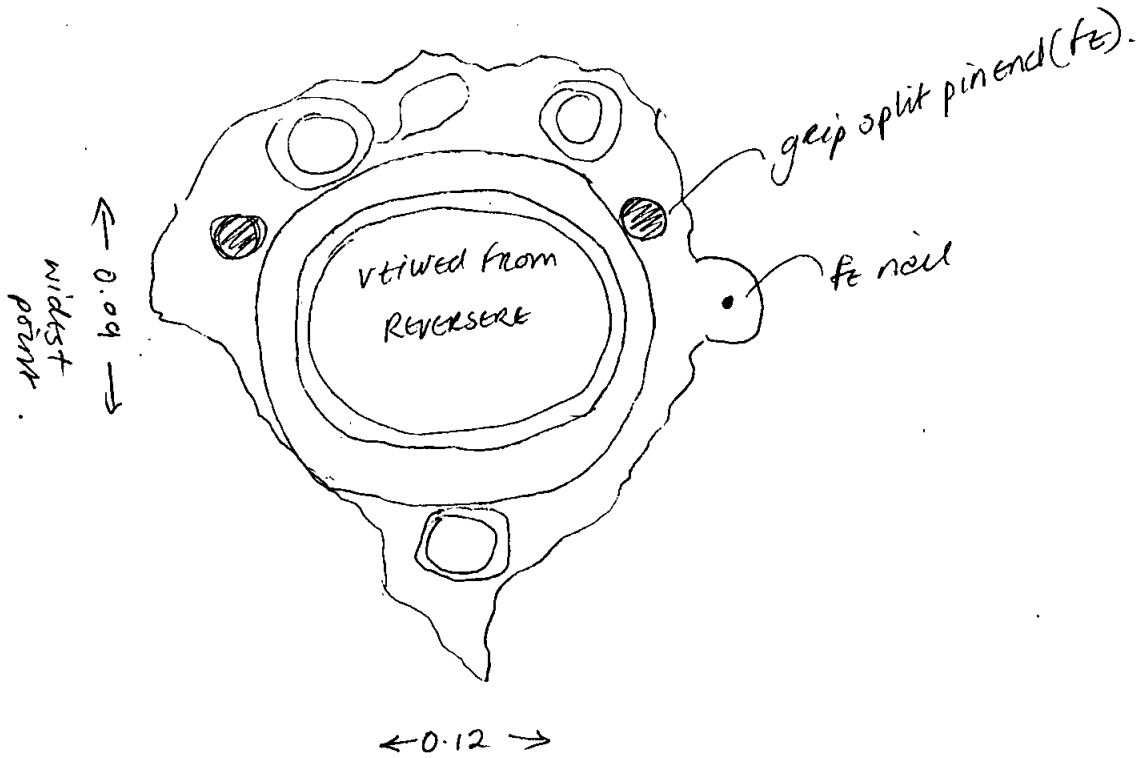

SITE <i>OL200</i>		COFFIN RECORD SHEET	CONTEXT NO. <i>1073</i>
Trench:	Additional sheets: <i>YES X 1</i>	Treatment: <i>INTACT</i> <i>⇒ NEEROP.</i>	
Site sub-div: <i>CRYPT</i>	Grave fills		
Plan no: <i>7</i>	Grave cut:	Finds	
Section no:	Skeleton:	None	
Co-ordinates:	Matrix location: <i>in Bay A adj'to 1071.</i>	Breastplate ✓ <i>ⓐ same as 7709534</i>	
Levels	Preservation:	Grip ✓ <i>3 x ⓑ + plates, broader foot plate ⓑ</i>	
Slide No.	Neg No:	Hinge	
		Bracket	
		Fixing nails	
		Shroud pins	
		Fabric <i>Fe studs on bottom &amp; top</i>	
		Other finds	

**Description**  
*adult pb. coffin, E → W*

**Discussion**

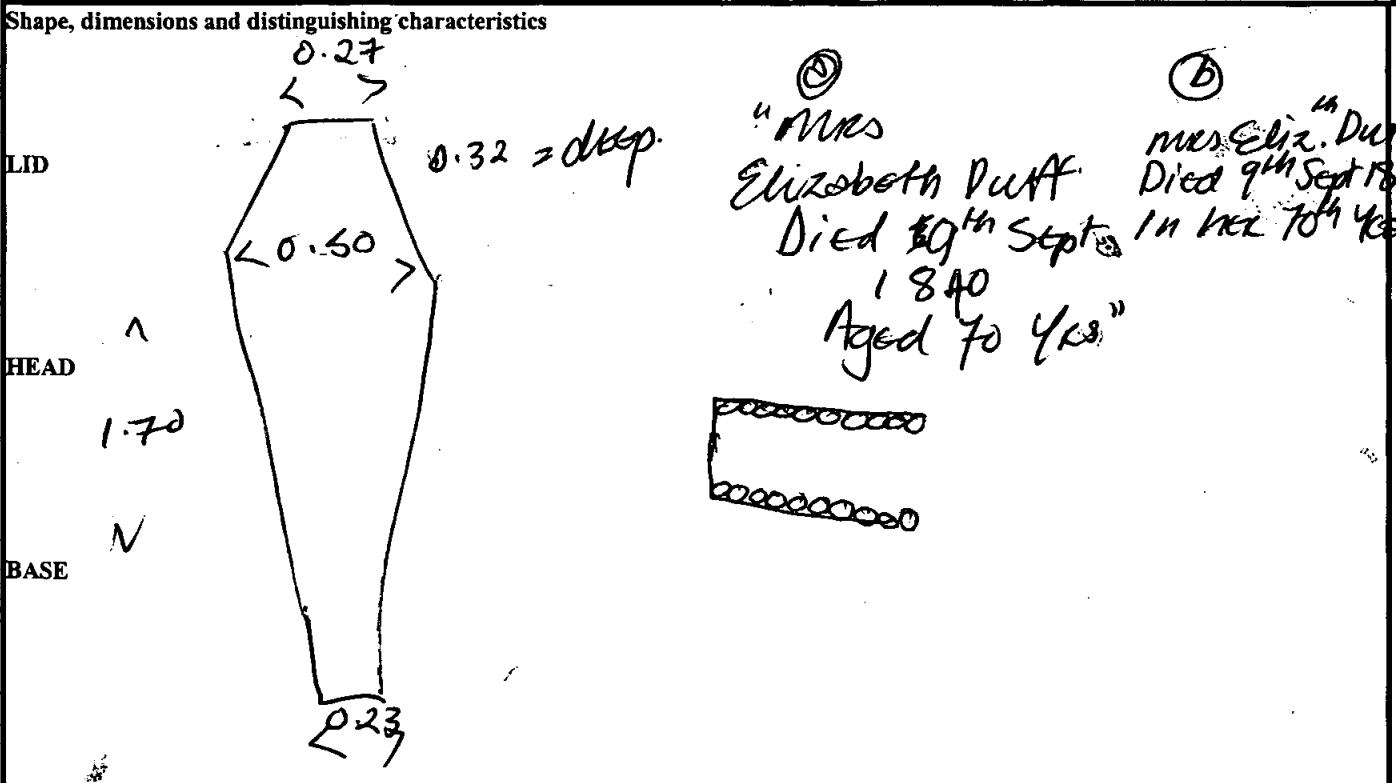

Recorder: *M61*      Date: *23/11*      Initials:

Outer Coffin

Sample Ret.

Site Code

Context

Recording Date ..... 23/11 .....

07208

1073

Associated Numbers .....

Condition .....

Dep. Plate

Legible

Inscription "Mrs Elizabeth Duff / Died 9th Sept / 1840 / Aged 70 Yrs"

Fabric lead  ormolou  brass  tin plated pewter  gilt tin   
 iron  silvered tin  enamelled  other ..... Sample Ret.

Shape of dep. plate

same as 776 w/ 534 outer border

square  rectangle  shield  tapered  lozenge   
 cartouche  oval  other .....

Upholstery

colour ..... shoddy  velvet  other ..... Sample Ret.

Construction

butt joint  mitred  pitched  other .....

Grip plate  Fabric = ormolou  brass  tin plated pewter  gilt tin   
 iron  silvered tin  enamelled  other ..... Sample Ret.

Grip  Fabric = ormolou  brass  iron  x 3 Sample Ret.

- must have, eccocow detail face - ~~size~~ could be 10?

Design swag of rose  horseshoe  cherub's head  4's. plain   
 other .....

Grip bolts  Corner bolts  Type = gilt brass  brass  iron

other ..... Sample Ret.

Lid motifs  other ..... Sample Ret.

Escutcheons  other ..... Sample Ret.

Upholstery nails  brass  gilt brass  silvered brass  iron  enamelled   
 other ..... Sample Ret.

Fixings  panel nails  screws  hinges  lace  Sample Ret.

Timber type ..... Sample Ret.

Interpretation / Comments

.....  
 .....

SITE		COFFIN RECORD SHEET		CONTEXT NO.	
02100		Additional sheets: 4/5 x 1.		1074	
Trench:		Grave fills		Treatment: - NO BONES SURVIVING NO DATA	
Site sub-div: CHIT BAY 2		Grave cut:		Finds	
Plan no: 7		Skeleton:		None	
Section no:		Matrix location: adj. to 915		Breastplate ✓ Grip	
Co-ordinates:		Preservation: COLLAPSED - SIDES / ROY / BOT		Hinge Bracket	
Levels		Neg No:		Fixing nails Shroud pins	
Slide No.		Fabric		Other finds	

**Description** Pb ADULT COFFIN.  
WEST EAST ALIGNED.  
OUTER WOOD - V. DECAYED.

**Discussion**

Inscription on Coffin: -  
~~~~~ = (ILLEGIBLE)  
1812  
Aged 96 yr

**Shape, dimensions and distinguishing characteristics**

OUTER Pb BREASTPLATE: -

LID Mrs. Lucretia  
Ann Wright  
Died 20th Augt.  
1812  
Aged 96 years

HEAD

BASE

DEPTH: - 0.24m

Recorder: Jm. Date: 25.11.00 Initials:

**Outer Coffin**

Sample Ret.

Site Code

Context

02200

1074

Recording Date ..... 4/12/00

Associated Numbers .....

Condition ..... 3

Dep. Plate

Legible

Inscription "Mrs Lucretia/Ann Wright/Died 20 Aug/1812/Aged 96 Yrs"

Fabric lead  ormolou  brass  tin plated pewter  gilt tin   
 iron  silvered tin  enamelled  other ..... Sample Ret.

Shape of dep. plate

⑥ w/ out any borders.

square  rectangle  shield  tapered  lozenge   
 cartouche  oval  other .....

Upholstery

colour ..... shoddy  velvet  other ..... Sample Ret.

Construction

butt joint  mitred  pitched  other .....

Grip plate  Fabric = ormolou  brass  tin plated pewter  gilt tin   
 iron  silvered tin  enamelled  other ..... Sample Ret.

Grip  Fabric = ormolou  brass  iron  Sample Ret.

Design swag of rose  horseshoe  cherub's head  plain   
 other .....

Grip bolts  Corner bolts  Type = gilt brass  brass  iron   
 other ..... Sample Ret.

Lid motifs  other ..... Sample Ret.

Escutcheons  other ..... Sample Ret.

Upholstery nails  brass  gilt brass  silvered brass  iron  enamelled   
 other ..... Sample Ret.

Fixings  panel nails  screws  hinges  lace  Sample Ret.

Timber type ..... Sample Ret.

Interpretation / Comments

.....  
 .....

| SITE                       |                                | COFFIN RECORD SHEET        |  | CONTEXT NO. |  |
|----------------------------|--------------------------------|----------------------------|--|-------------|--|
| 02100                      |                                |                            |  | 1075        |  |
| Trench:                    | Additional sheets:             | Treatment:                 |  |             |  |
| Site sub-div:<br>CUMT 6A12 | Grave fills                    | Bones x1 lifted.<br>NO DNA |  |             |  |
| Plan no:<br>7              | Grave cut:                     | Finds                      |  |             |  |
| Section no:                | Skeleton:                      | None                       |  |             |  |
| Co-ordinates:              | Matrix location:<br>adj to 918 | Breastplate                |  |             |  |
| Levels                     | Preservation:                  | Grip                       |  |             |  |
| Slide No.                  | Neg No:                        | Hinge                      |  |             |  |
|                            |                                | Bracket                    |  |             |  |
|                            |                                | Fixing nails               |  |             |  |
|                            |                                | Shroud pins                |  |             |  |
|                            |                                | Fabric                     |  |             |  |
|                            |                                | Other finds                |  |             |  |

**Description** Pb ADULT COFFIN  
WEST-EAST.  
OUTER WOOD - V. DECAYED.

**Discussion**

**Shape, dimensions and distinguishing characteristics**  
OUTER BREASTPLATE:-

**LID**

Mrs  
Arabella Feast  
Died 5th August  
1789  
In her 78th Year

**HEAD**

**BASE**

0.32m  
0.60m  
1.80m  
0.24m  
DEPTH: 0.36m

Recorder: *Dm* Date: 25.11.00 Initials:

# Coffin Recording Sheet

Site Code

Context

**Outer Coffin**

Sample Ret.

OH200

1075

Recording Date .....

Associated Numbers .....

Condition 4

Dep. Plate

Legible

Inscription *inscription (007?)  
"Mrs/Arabella Peart/Died 5th August/1789/In her 78th Year"*

*see following sheet for boarded details*

Fabric lead  ormolou  brass  tin plated pewter   
 iron  silvered tin  enamelled  other ..... gilt tin  Sample Ret.

**Shape of dep. plate**

square  rectangle  shield  tapered  lozenge   
 cartouche  oval  other .....

**Upholstery**

colour ..... shoddy  velvet  other ..... Sample Ret.

**Construction**

butt joint  mitred  pitched  other .....

**Grip plate**

Fabric = ormolou  brass  tin plated pewter  gilt tin

iron  silvered tin  enamelled  other ..... Sample Ret.

**Grip**

Fabric = ormolou  brass  iron  Sample Ret.

**Design**

swag of rose  horseshoe  cherub's head  plain

other .....

**Grip bolts**

Corner bolts  Type = gilt brass  brass  iron

other ..... Sample Ret.

**Lid motifs**

other ..... Sample Ret.

**Escutcheons**

other ..... Sample Ret.

**Upholstery nails**

brass  gilt brass  silvered brass  iron  enamelled

other ..... Sample Ret.

**Fixings**

panel nails  screws  hinges  lace  Sample Ret.

**Timber type** .....

Sample Ret.

**Interpretation / Comments**

.....  
 .....

OhR00

1075  
cont.

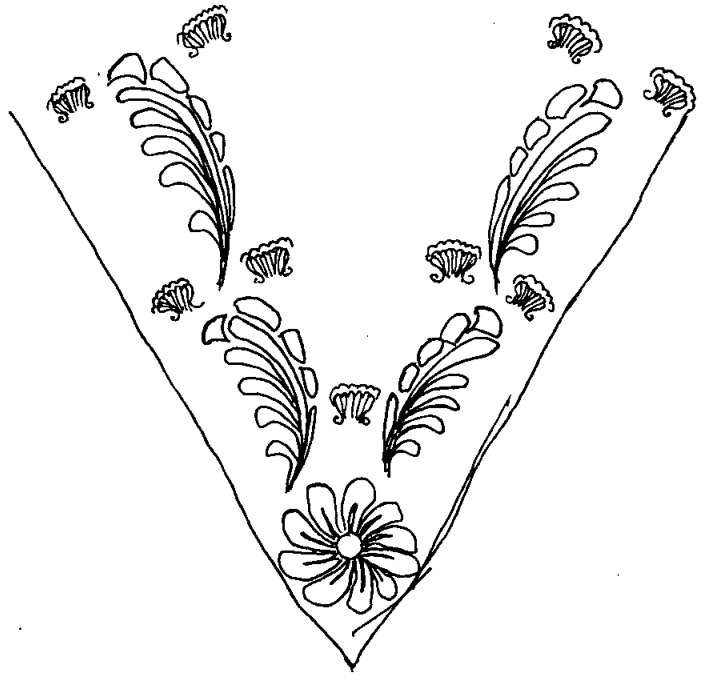
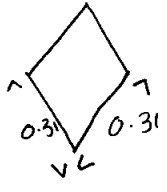



|                               |                                      |                                                          |
|-------------------------------|--------------------------------------|----------------------------------------------------------|
| SITE<br><i>OR00</i>           | COFFIN RECORD SHEET                  | CONTEXT NO.<br><i>1076</i>                               |
| Trench:<br><i>C</i>           | Additional sheets:<br><i>483 x 1</i> | Treatment:<br><i>INTACT</i><br><i>⇒ NECROP</i>           |
| Site sub-div:<br><i>CRYPT</i> | Grave fills                          |                                                          |
| Plan no:<br><i>7</i>          | Grave cut:                           | Finds<br>None<br><i>inscrip - rect plan</i> <sup>⊙</sup> |
| Section no:                   | Skeleton:                            | Breastplate <input checked="" type="checkbox"/><br>Grip  |
| Co-ordinates:                 | Matrix location:<br><i>9h Bay A</i>  | Hinge<br>Bracket                                         |
| Levels                        | Preservation:<br><i>4</i>            | Fixing nails<br>Shroud pins                              |
| Slide No.                     | Neg No:                              | Fabric<br>Other finds                                    |

Description *Sub adult p.b coffin, W 7 E*

Discussion

Shape, dimensions and distinguishing characteristics

LID

*L0.22<sup>s</sup>*

*= 0.18 deep*

<sup>⊙</sup>  
*Miss  
Caroline Joselin  
Died 6<sup>th</sup> Dec<sup>r</sup>  
1823  
In her 10<sup>th</sup> year*

HEAD

*1.27.*

*L0.367*

BASE

*L 7  
0.17*

Recorder: *Mel*

Date: *27/11*

Initials:

# Coffin Recording Sheet

**Outer Coffin**

Sample Ret.

Site Code

Context

Recording Date ..... 28/11/00

OLR00

1076

Associated Numbers .....

Condition ..... 2

Dep. Plate

Legible

Inscription: "Cordine Joselin / Died 6<sup>th</sup> Dec / 1823 / Aged 9 Years"

Fabric lead  ormolou  brass  tin plated pewter  gilt tin   
 iron  silvered tin  enamelled  other ..... Sample Ret.

Some as 841 w/ (AG) border.

**Shape of dep. plate**

square  rectangle  shield  tapered  lozenge   
 cartouche  oval  other .....

**Upholstery**

colour ..... shoddy  velvet  other ..... Sample Ret.

**Construction**

butt joint  mitred  pitched  other .....

Grip plate  Fabric = ormolou  brass  tin plated pewter  gilt tin   
 iron  silvered tin  enamelled  other ..... Sample Ret.

Grip  Fabric = ormolou  brass  iron  Sample Ret.

Design swag of rose  horseshoe  cherub's head  plain   
 other .....

Grip bolts  Corner bolts  Type = gilt brass  brass  iron   
 other ..... Sample Ret.

Lid motifs  other ..... Sample Ret.

Escutcheons  other ..... Sample Ret.

Upholstery nails  brass  gilt brass  silvered brass  iron  enamelled   
 other ..... Sample Ret.

Fixings  panel nails  screws  hinges  lace  Sample Ret.

Timber type ..... Sample Ret.

**Interpretation / Comments**

.....  
 .....

| SITE                | COFFIN RECORD SHEET       | CONTEXT NO.                                                           |
|---------------------|---------------------------|-----------------------------------------------------------------------|
| 02R00               |                           | 1077                                                                  |
| Trench:             | Additional sheets: Yes 2. | Treatment: INTACT $\Rightarrow$<br>NEED                               |
| Site sub-div: CRYPT | Grave fills               |                                                                       |
| Plan no: 7          | Grave cut:                | Finds<br>None inscript. dir above. $\textcircled{a}$                  |
| Section no:         | Skeleton:                 | Breastplate <input checked="" type="checkbox"/><br>Head plate<br>Grip |
| Co-ordinates:       | Matrix location: in Bay A | Hinge<br>Bracket                                                      |
| Levels              | Preservation:             | Fixing nails<br>Shroud pins                                           |
| Slide No.           | Neg No:                   | Fabric<br>Other finds                                                 |

Description sub adult. p.b. N  $\Rightarrow$  WE

Discussion

Shape, dimensions and distinguishing characteristics

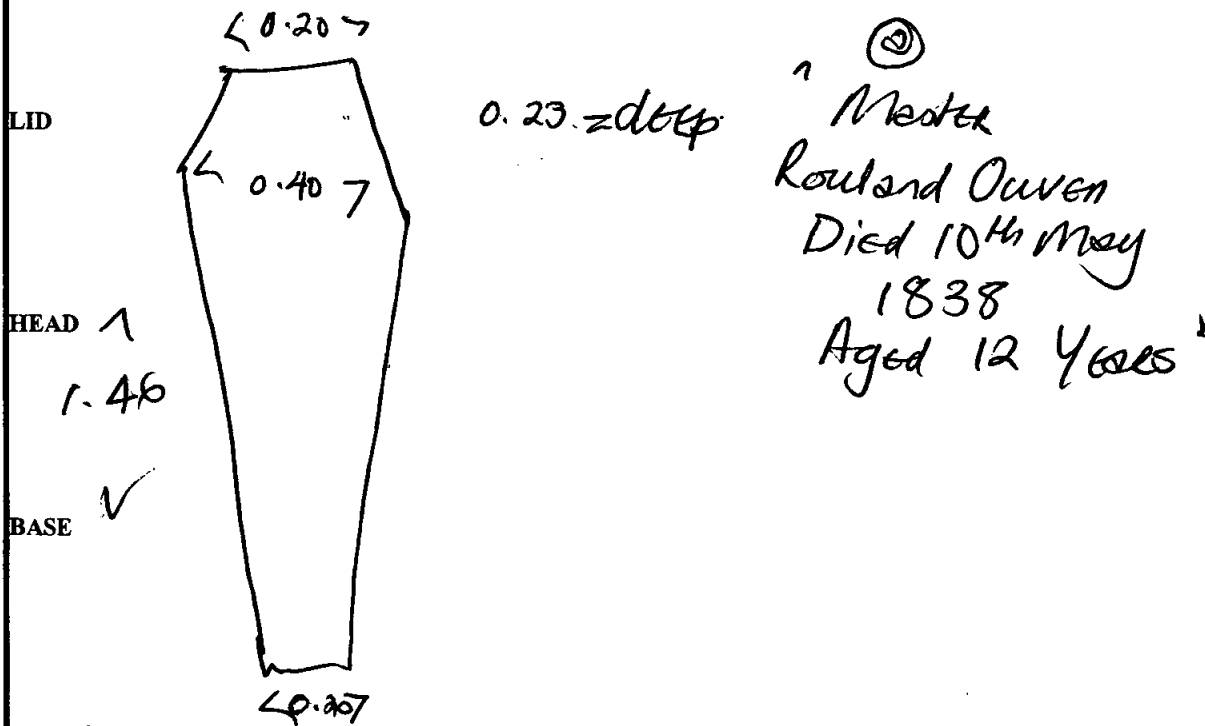

|               |             |           |
|---------------|-------------|-----------|
| Recorder: MEL | Date: 27/11 | Initials: |
|---------------|-------------|-----------|

Site Code

Context

Outer Coffin

Sample Ret.

OH200

1077

Recording Date ..... 29/11 .....

Associated Numbers .....

Condition ..... 3 ..... <sup>ⓐ</sup> Dep. Plate  Legible

Inscription "Master Rowland Owen / Died 10<sup>th</sup> May / 1838 / Aged 12 Years"  
<sup>ⓑ</sup> + Head/foot plate (see bottom of page)

Fabric lead  ormolou  brass  tin plated pewter  gilt tin   
 iron  silvered tin  enamelled  other ..... Sample Ret.

Shape of dep. plate ..... *new type - see sheet.*  
 square  rectangle  shield  tapered  lozenge   
 cartouche  oval  other .....

Upholstery   
 colour ..... shoddy  velvet  other ..... Sample Ret.

Construction ..... butt joint  mitred  pitched  other .....

Grip plate  Fabric = ormolou  brass  tin plated pewter  gilt tin   
 iron  silvered tin  enamelled  other ..... Sample Ret.

Grip  Fabric = ormolou  brass  iron  Sample Ret.

Design ..... swag of rose  horseshoe  cherub's head  plain   
 other ..... *infant ← 0.12 ↓ 0.05.*

Grip bolts  Corner bolts  Type = gilt brass  brass  iron   
 other ..... Sample Ret.

Lid motifs  other ..... Sample Ret.

Escutcheons  other ..... Sample Ret.

Upholstery nails  brass  gilt brass  silvered brass  iron  enamelled   
 other ..... Sample Ret.

Fixings  panel nails  screws  hinges  lace  Sample Ret.

Timber type ..... Sample Ret.

Interpretation / Comments "Master Rowland Owen / Died 10<sup>th</sup> May / 1838 / Aged 12 Years"  
<sup>ⓑ</sup> p-b. rect. w/ patterned border (11/11)

| SITE <i>OR 003</i>         |                                   | COFFIN RECORD SHEET                                                                 | CONTEXT NO. <i>1078</i> |
|----------------------------|-----------------------------------|-------------------------------------------------------------------------------------|-------------------------|
| Trench:                    | Additional sheets: <i>YES x 1</i> | Treatment: <i>BONES LIFTED</i><br><i>↳ DNA TAKEN</i>                                |                         |
| Site sub-div: <i>CRMP1</i> | Grave fills                       |                                                                                     |                         |
| Plan no: <i>7</i>          | Grave cut:                        | Finds                                                                               |                         |
| Section no:                | Skeleton:                         | None<br>head/post ✓<br>Breastplate ✓<br><i>miscrip - ect. ②</i><br>Grip ✓ <i>lx</i> |                         |
| Co-ordinates:              | Matrix location: <i>Boy A</i>     | Hinge                                                                               |                         |
| Levels                     | Preservation: <i>2</i>            | Bracket                                                                             |                         |
| Slide No.                  | Neg No:                           | Fixing nails                                                                        |                         |
|                            |                                   | Shroud pins                                                                         |                         |
|                            |                                   | Fabric                                                                              |                         |
|                            |                                   | Other finds                                                                         |                         |

Description *adult p.b coffin, E → W, beam in coffin @ head end.*

Discussion

Shape, dimensions and distinguishing characteristics

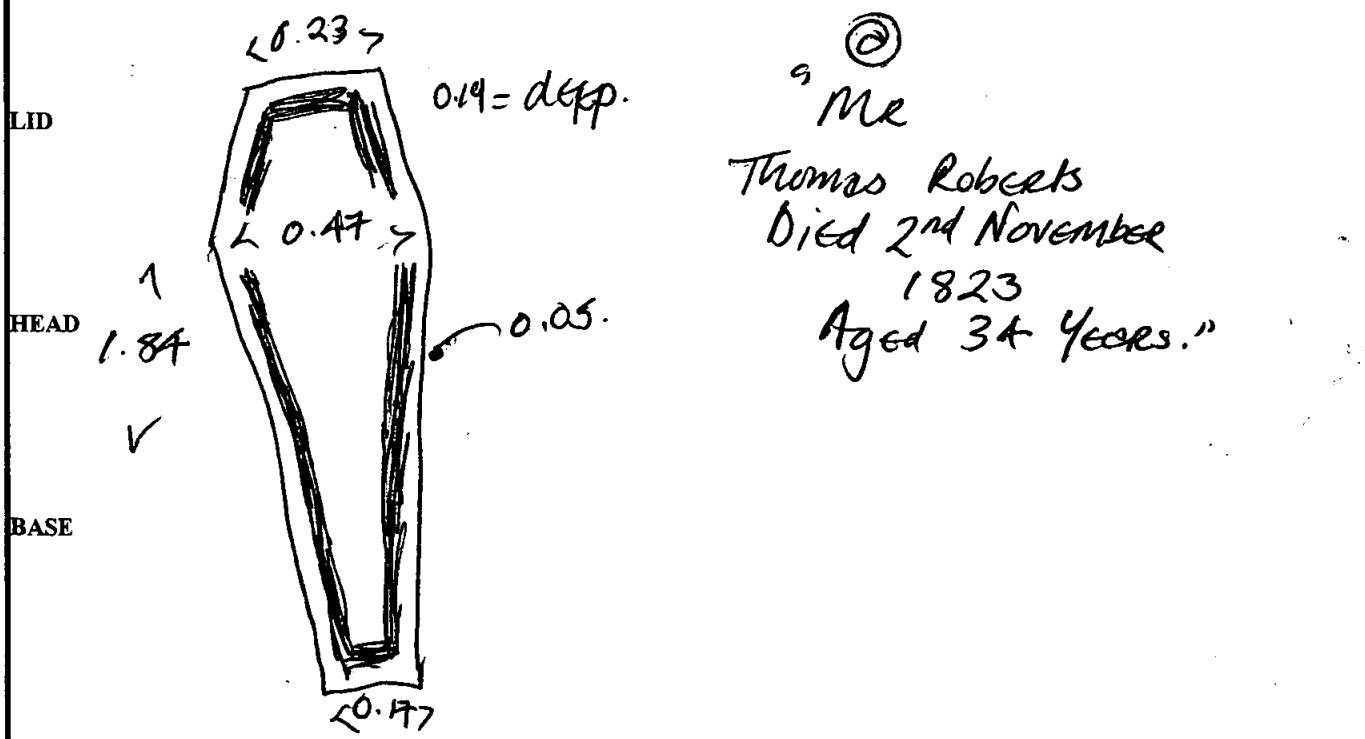

|                      |                    |           |
|----------------------|--------------------|-----------|
| Recorder: <i>Mel</i> | Date: <i>27/11</i> | Initials: |
|----------------------|--------------------|-----------|

Site Code

Context

**Outer Coffin**

Sample Ret.

OH200

1078

Recording Date ..... 28/11 .....

Associated Numbers .....

Condition

2

foot/head  
-Dep. Plate

Legible

Inscription

"Mr Thos Roberts / Died 2<sup>nd</sup> Nov<sup>r</sup>: 182<sup>d</sup> / Aged 34 Years"

Fabric lead

iron

ormolou

silvered tin

brass

enamelled

tin plated pewter

other .....

gilt tin

Sample Ret.

**Shape of dep. plate**

square

rectangle  plain

shield

tapered

lozenge

cartouche

oval

other .....

**Upholstery**

colour .....

shoddy

velvet

other .....

Sample Ret.

**Construction**

butt joint

mitred

pitched

other .....

**Grip plate**

iron

Fabric = ormolou

silvered tin

brass

enamelled

tin plated pewter

other .....

gilt tin

Sample Ret.

**Grip**

Fabric = ormolou

brass

iron

Sample Ret.

**Design**

swag of rose

horseshoe

cherub's head  ①

plain

other .....

**Grip bolts**

**Corner bolts**

Type = gilt brass

brass

iron

other ..... Sample Ret.

**Lid motifs**

other .....

Sample Ret.

**Escutcheons**

other .....

Sample Ret.

**Upholstery nails**

brass

gilt brass

silvered brass

iron

enamelled

other ..... Sample Ret.

**Fixings**

panel nails

screws

hinges

lace

Sample Ret.

**Timber type**

Sample Ret.

**Interpretation / Comments**

.....  
.....

| SITE                | COFFIN RECORD SHEET                  | CONTEXT NO.                                                                                 |
|---------------------|--------------------------------------|---------------------------------------------------------------------------------------------|
| 0600                |                                      | 1079                                                                                        |
| Trench:             | Additional sheets: 465 x2            | Treatment: INTACT $\rightarrow$ NECROP.                                                     |
| Site sub-div: CRYPT | Grave fills                          |                                                                                             |
| Plan no: 7          | Grave cut:                           | Finds<br>None<br>inscript die aboard                                                        |
| Section no:         | Skeleton:                            | Breastplate <input checked="" type="checkbox"/><br>Grip <input checked="" type="checkbox"/> |
| Co-ordinates:       | Matrix location: Bay A. 0/L<br>1082. | Hinge<br>Bracket                                                                            |
| Levels              | Preservation:                        | Fixing nails<br>Shroud pins                                                                 |
| Slide No.           | Neg No:                              | Fabric<br>Other finds                                                                       |

Description adult p.b coffin. R  $\rightarrow$  W

Discussion

Shape, dimensions and distinguishing characteristics

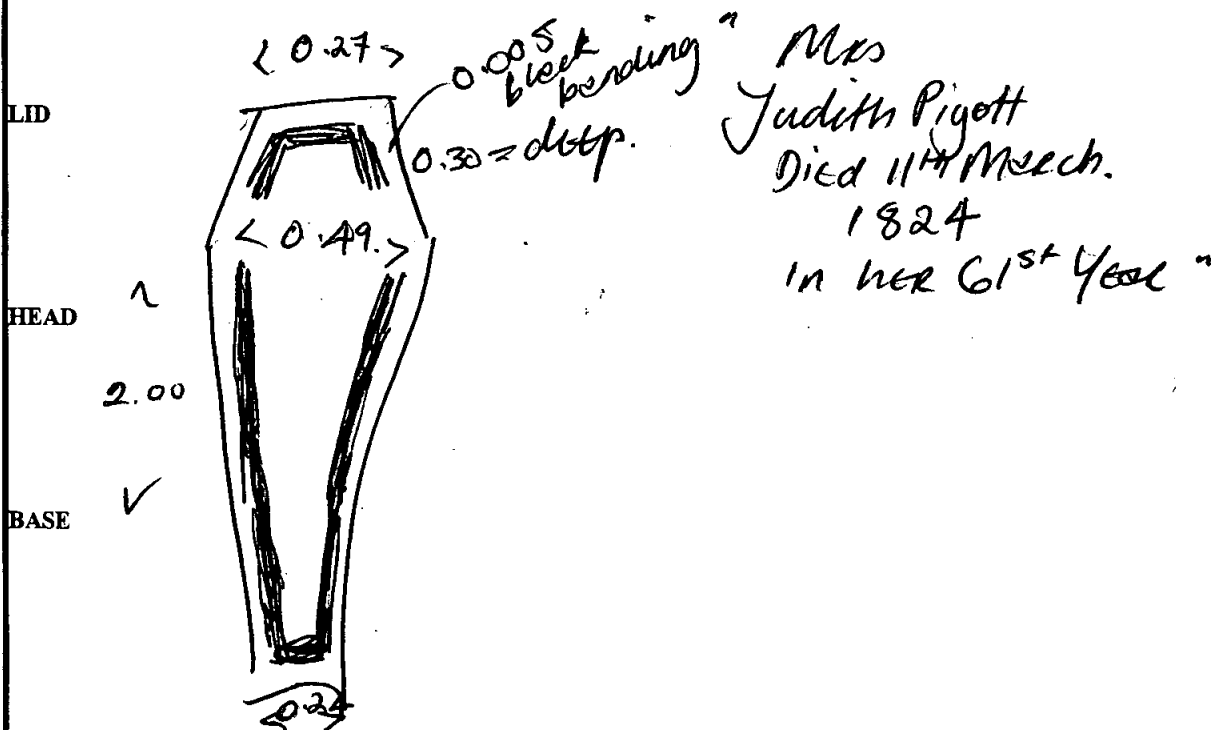

|                 |             |           |
|-----------------|-------------|-----------|
| Recorder: M. G. | Date: 27/11 | Initials: |
|-----------------|-------------|-----------|

# Coffin Recording Sheet

Site Code

Context

**Outer Coffin**

Sample Ret.

OL200

1079

Recording Date ..... 28/11 .....

Associated Numbers .....

Condition ..... 3 .....

Dep. Plate

Legible

Inscription "Mrs/Judith Pigott/Died 11<sup>th</sup> March/1824/In her 61<sup>st</sup> Year"

Fabric lead  ormolou  brass  tin plated pewter  gilt tin   
 iron  silvered tin  enamelled  other ..... Sample Ret.

*Block polished. Tapered version of feet (82) w/ bottom (see over) & w/ 7.15 inner tapered  copper lozenge  outer border.*

**Shape of dep. plate**

square  rectangle  shield   
 cartouche  oval  other .....

**Upholstery**

colour ..... shoddy  velvet  other *Boize* ..... Sample Ret.

**Construction** butt joint  mitred  pitched  other .....

**Grip plate**  Fabric = ormolou  brass  tin plated pewter  gilt tin   
 iron  *flaps on ees of grip = wood* silvered tin  enamelled  other ..... Sample Ret.

**Grip**  Fabric = ormolou  brass  iron  x1 Sample Ret.

**Design** swag of rose  horseshoe  cherub's head  (A) plain   
 other .....

**Grip bolts**  **Corner bolts**  **Type =** gilt brass  brass  iron   
 other ..... Sample Ret.

**Lid motifs**  other ..... Sample Ret.

**Escutcheons**  other ..... Sample Ret.

**Upholstery nails**  brass  gilt brass  silvered brass  iron  enamelled   
 other ..... Sample Ret.

**Fixings**  panel nails  screws  hinges  lace  Sample Ret.

**Timber type** ..... Sample Ret.

**Interpretation / Comments**

.....  
 .....



0200

1079

cont.

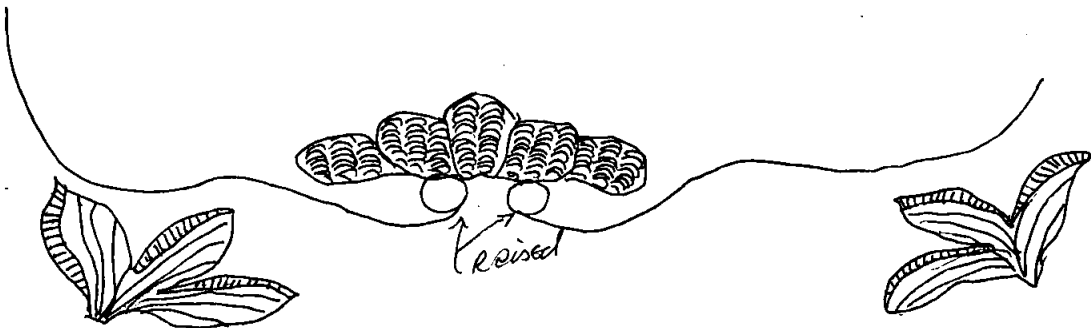

|                            |                                                 |                                            |
|----------------------------|-------------------------------------------------|--------------------------------------------|
| SITE<br><i>OH100</i>       | COFFIN RECORD SHEET                             | CONTEXT NO.<br><i>1080</i>                 |
| Trench:                    | Additional sheets: <i>4/23 x 1</i>              | Treatment: <i>INTACT</i> ✓                 |
| Site sub-div: <i>CRYPT</i> | Grave fills                                     | <i>NECROP.</i>                             |
| Plan no:<br><i>7</i>       | Grave cut:                                      | Finds<br>None <i>inscript dia edon</i> (2) |
| Section no:                | Skeleton:                                       | Breastplate ✓<br>Grip ✓ <i>OR</i>          |
| Co-ordinates:              | Matrix location: <i>OH 1083</i><br><i>Bay A</i> | Hinge<br>Bracket                           |
| Levels                     | Preservation:<br><i>4</i>                       | Fixing nails<br>Shroud pins                |
| Slide No.                  | Neg No:                                         | Fabric<br>Other finds                      |

Description *adult pb coffin, W → E.*

Discussion

Shape, dimensions and distinguishing characteristics

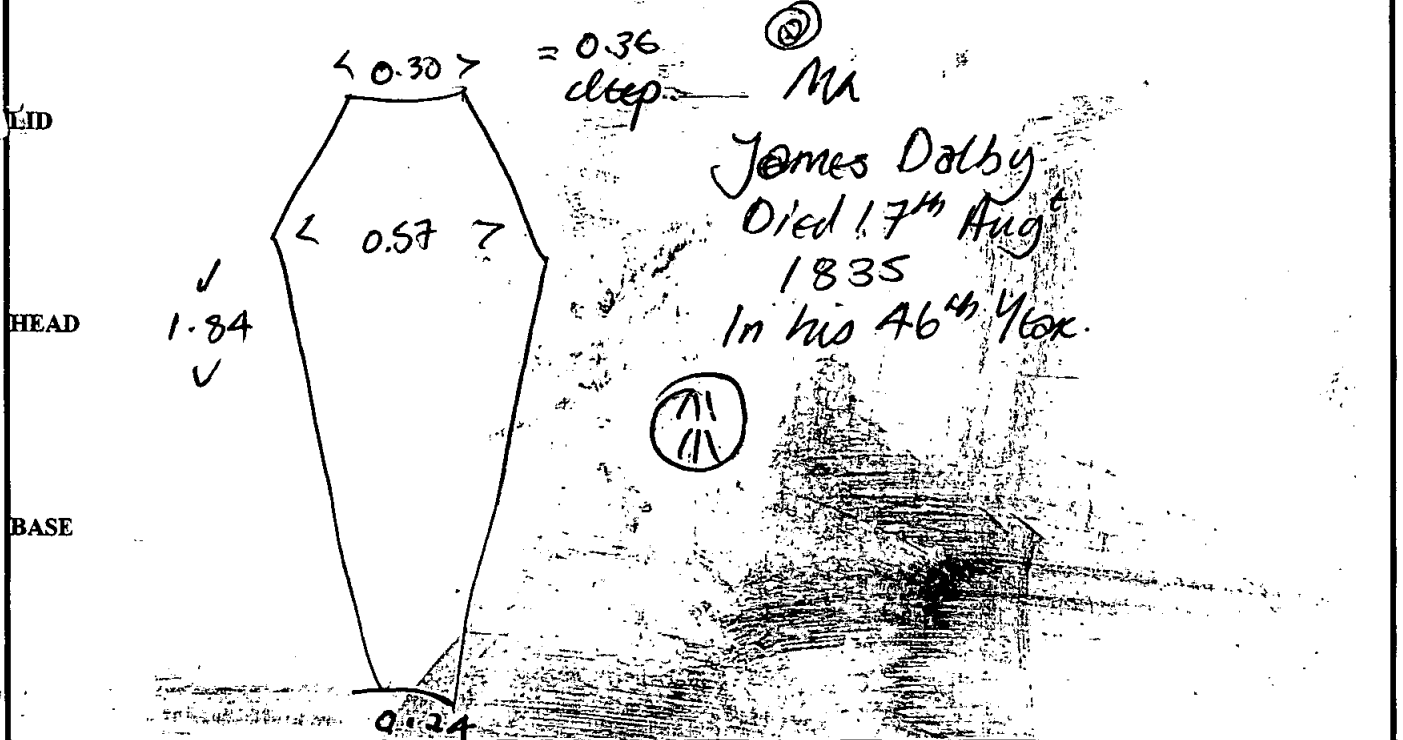

|                      |                    |           |
|----------------------|--------------------|-----------|
| Recorder: <i>McL</i> | Date: <i>27/11</i> | Initials: |
|----------------------|--------------------|-----------|

Outer Coffin

Sample Ret.

Site Code

Context

Recording Date ..... 28/11/00

OL00

1080

Associated Numbers .....

Condition ..... 3

Dep. Plate

Legible

Inscription "MR/James Dalby/Died 17<sup>th</sup> Aug<sup>st</sup> 1835/In his 46<sup>th</sup> Year"

Fabric lead  ormolou  brass  tin plated pewter  gilt tin   
 iron  silvered tin  enamelled  other ..... Sample Ret.

Shape of dep. plate

*spthds (21) w/ 534 outer border*

square  rectangle  shield  tapered  lozenge   
 cartouche  oval  other .....

Upholstery

colour ..... shoddy  velvet  other ..... Sample Ret.

Construction

butt joint  mitred  pitched  other .....

Grip plate  Fabric = ormolou  brass  tin plated pewter  gilt tin   
 iron  *Feags on rev of grips* silvered tin  enamelled  other ..... Sample Ret.

Grip  Fabric = ormolou  brass  iron  *x2* Sample Ret.

Design swag of rose  horseshoe  cherub's head  *(6)'s* plain   
 other .....

Grip bolts  Corner bolts  Type = gilt brass  brass  iron

other ..... Sample Ret.

Lid motifs  other ..... Sample Ret.

Escutcheons  other ..... Sample Ret.

Upholstery *studs*  brass  gilt brass  silvered brass  iron  enamelled   
 other *1x 800 / 1x 00 / 1x 000 = 9 studs in total.* Sample Ret.

Fixings  panel nails  screws  hinges  lace  Sample Ret.

Timber type ..... Sample Ret.

Interpretation / Comments

.....  
 .....

| SITE <i>OR 200</i>          |                               | COFFIN RECORD SHEET                                  |  | CONTEXT NO. <i>1081</i> |  |
|-----------------------------|-------------------------------|------------------------------------------------------|--|-------------------------|--|
| Trench:                     | Additional sheets:            | Treatment: <i>INTACT</i><br><i>⇒ NBEROP</i>          |  |                         |  |
| Site sub-div: <i>CAMP 7</i> | Grave fills                   |                                                      |  |                         |  |
| Plan no: <i>7</i>           | Grave cut:                    | Finds<br>None                                        |  |                         |  |
| Section no:                 | Skeleton:                     | Breastplate<br><i>incrip die - illegible</i><br>Grip |  |                         |  |
| Co-ordinates:               | Matrix location: <i>Box 4</i> | Hinge<br>Bracket                                     |  |                         |  |
| Levels                      | Preservation: <i>magnt 4</i>  | Fixing nails<br>Shroud pins                          |  |                         |  |
| Slide No.                   | Neg No:                       | Fabric<br>Other finds                                |  |                         |  |

Description *S → N, skull pb.*

Discussion

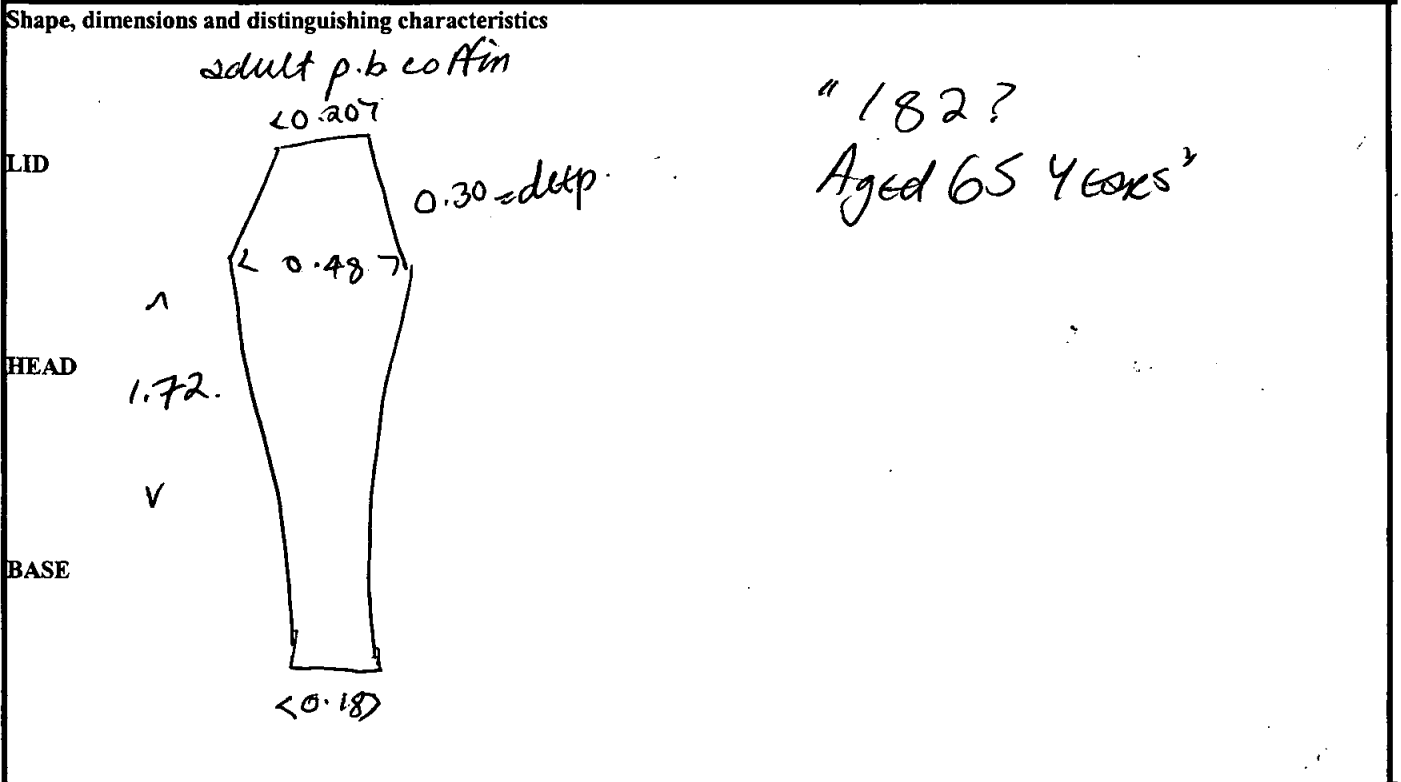

|                      |                    |           |
|----------------------|--------------------|-----------|
| Recorder: <i>MEL</i> | Date: <i>28/11</i> | Initials: |
|----------------------|--------------------|-----------|

| SITE                |  | COFFIN RECORD SHEET                |  | CONTEXT NO.                            |  |
|---------------------|--|------------------------------------|--|----------------------------------------|--|
| 0200                |  | Additional sheets: 483 x 1         |  | Treatment: INTACT<br>⇒ NECROP          |  |
| Trench:             |  | Grave fills                        |  | Finds                                  |  |
| Site sub-div: CRYP7 |  | Grave cut:                         |  | None                                   |  |
| Plan no: 7          |  | Skeleton:                          |  | Breastplate ✓<br>inscrip dir ⊙<br>Grip |  |
| Section no:         |  | Matrix location: 4/6 1079<br>Bay 4 |  | Hinge                                  |  |
| Co-ordinates:       |  | Preservation: 4                    |  | Bracket                                |  |
| Levels              |  | Neg No:                            |  | Fixing nails                           |  |
| Slide No.           |  |                                    |  | Shroud pins                            |  |
|                     |  |                                    |  | Fabric                                 |  |
|                     |  |                                    |  | Other finds                            |  |

Description: skull p.b - 1 E → W

Discussion:

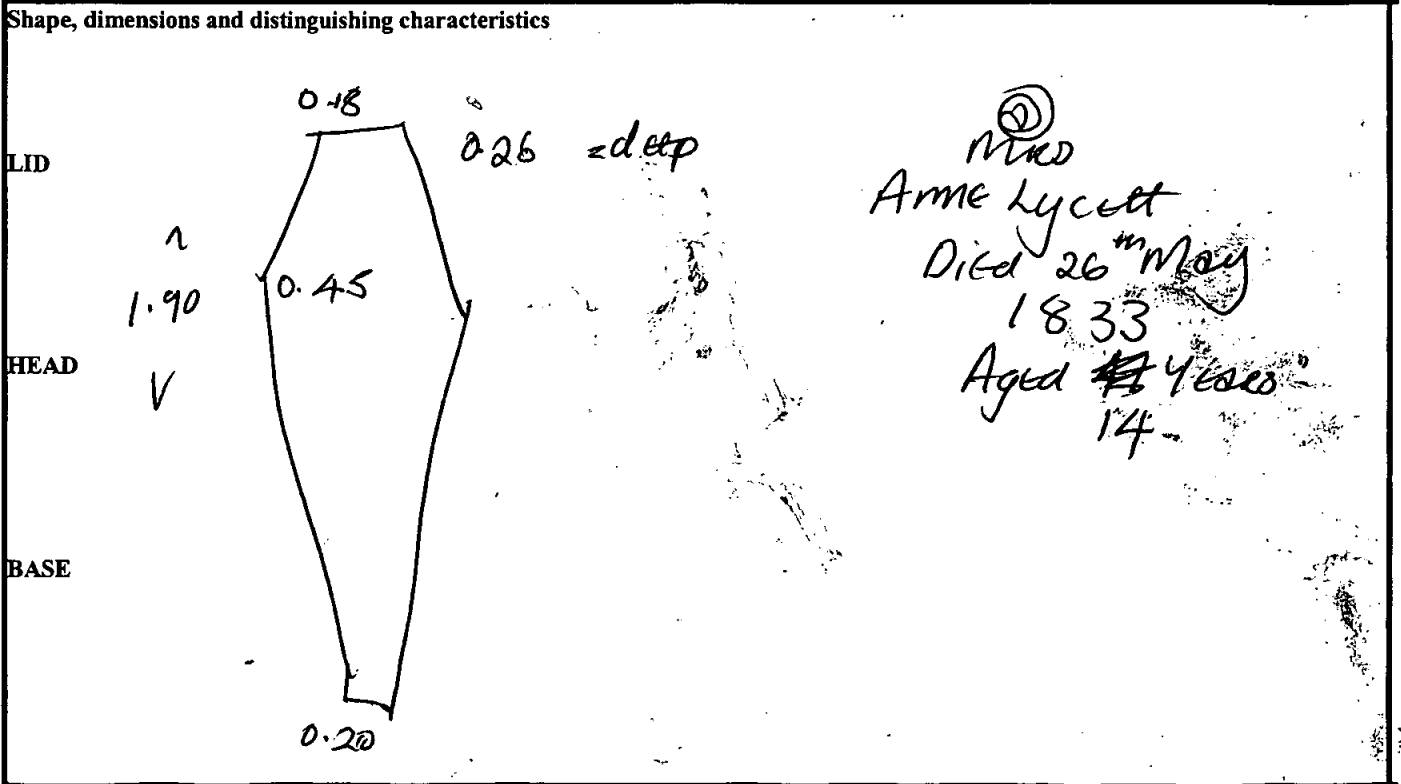

|               |             |           |
|---------------|-------------|-----------|
| Recorder: Mel | Date: 28/11 | Initials: |
|---------------|-------------|-----------|

**Outer Coffin**

Sample Ret.

Site Code

Context

Recording Date ..... 28/11/00

OR00

1082

Associated Numbers .....

Condition ..... 2

Dep. Plate

Legible

Inscription *Miss Anne Lyceby Died 26<sup>th</sup> May / 1833 / Aged 14 Years*

Fabric lead  ormolou  brass  tin plated pewter  gilt tin   
 iron  silvered tin  enamelled  other ..... Sample Ret.

*Spld (21) w/out outer border.*

**Shape of dep. plate**

square  rectangle  shield  tapered  lozenge   
 cartouche  oval  other .....

**Upholstery**

colour ..... shoddy  velvet  other ..... Sample Ret.

**Construction**

butt joint  mitred  pitched  other .....

**Grip plate**

Fabric = ormolou  brass  tin plated pewter  gilt tin

iron  silvered tin  enamelled  other ..... Sample Ret.

**Grip**

Fabric = ormolou  brass  iron  Sample Ret.

**Design**

swag of rose  horseshoe  cherub's head  plain

other .....

**Grip bolts**

Corner bolts  Type = gilt brass  brass  iron

other ..... Sample Ret.

**Lid motifs**

other .....

Sample Ret.

**Escutcheons**

other .....

Sample Ret.

**Upholstery nails**

brass  gilt brass  silvered brass  iron  enamelled

other ..... Sample Ret.

**Fixings**

panel nails  screws  hinges  lace  Sample Ret.

**Timber type** .....

Sample Ret.

**Interpretation / Comments**

.....  
 .....

|                     |                                   |                                               |
|---------------------|-----------------------------------|-----------------------------------------------|
| SITE<br>0200        | COFFIN RECORD SHEET               | CONTEXT NO.<br>1083                           |
| Trench:             | Additional sheets: YES & 2        | Treatment: INTACT<br>⇒ NECROP                 |
| Site sub-div: CRYPT | Grave fills                       |                                               |
| Plan no:<br>7       | Grave cut:                        | Finds<br>None                                 |
| Section no:         | Skeleton:                         | Breastplate ✓<br>& Neck. (C)<br>Grip & studs. |
| Co-ordinates:       | Matrix location: w/ 1080<br>Bay A | Hinge                                         |
| Levels              | Preservation: 4                   | Bracket                                       |
| Slide No.           | Neg No:                           | Fixing nails                                  |
|                     |                                   | Shroud pins                                   |
|                     |                                   | Fabric                                        |
|                     |                                   | Other finds                                   |

Description: slab adult p. b. coffin, W → E

Discussion:

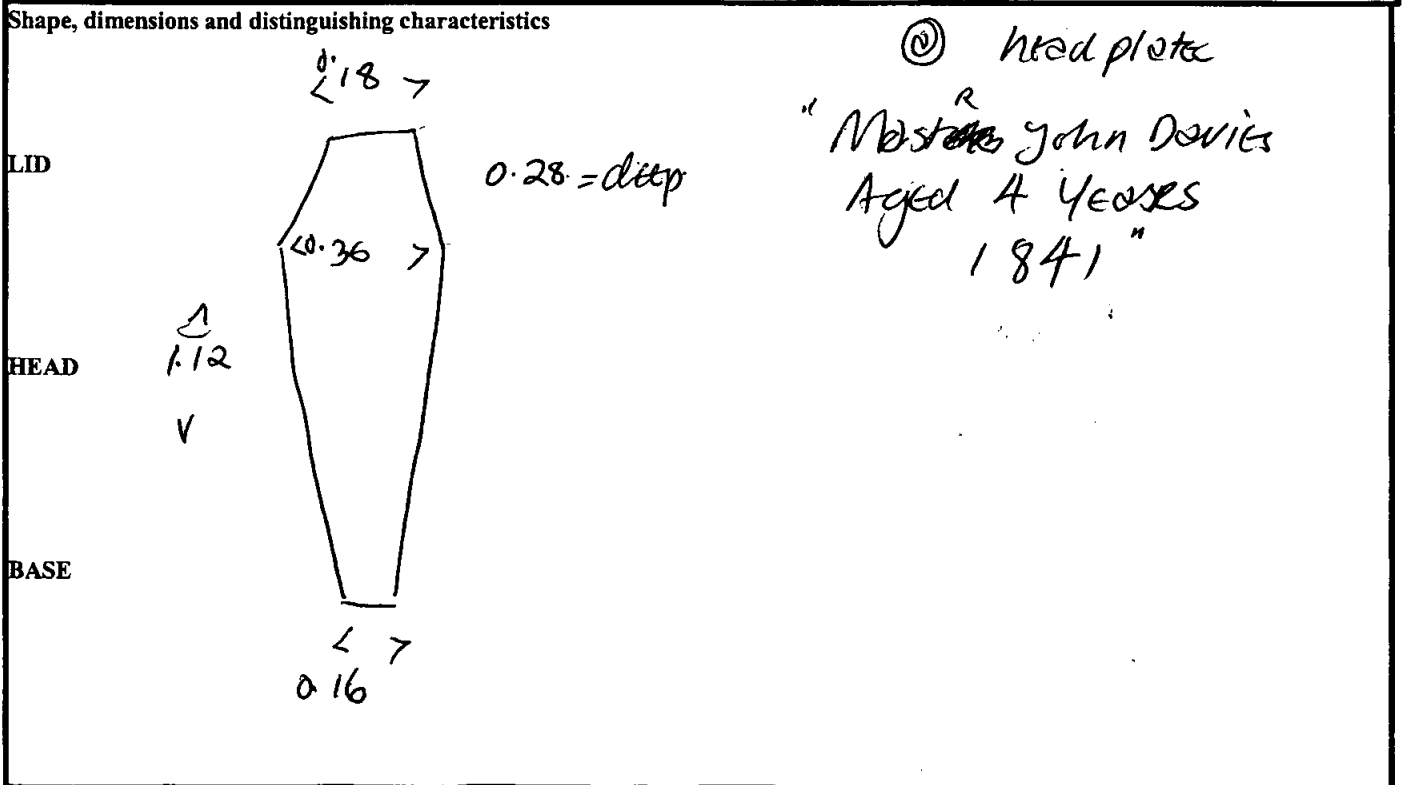

|               |             |           |
|---------------|-------------|-----------|
| Recorder: Mcl | Date: 28/11 | Initials: |
|---------------|-------------|-----------|

Site Code

Context

Outer Coffin

Sample Ret.

04200

1083

Recording Date ..... 28/4/00 .....

Associated Numbers .....

Condition ..... 1 ..... Dep. Plate  Legible  LSH

Inscription \* + head plate  
 "Master/John Davies/Died 14 Ju.../1840/Aged 4? Years"

Fabric lead  ormolou  brass  tin plated pewter  gilt tin   
 iron  silvered tin  enamelled  other ..... Sample Ret.

*infant dep plate - new type (see sheet).*

Shape of dep. plate

square  rectangle  shield  tapered  lozenge   
 cartouche  oval  other .....

Upholstery

colour ..... shoddy  velvet  other ..... Sample Ret.

Construction

butt joint  mitred  pitched  other .....

Grip plate

Fabric = ormolou  brass  tin plated pewter  (3) gilt tin   
 iron  silvered tin  enamelled  other ..... Sample Ret.

Grip

Fabric = ormolou  brass  iron  Sample Ret.

Design

swag of rose  horseshoe  cherub's head  plain

other .....

Grip bolts

Corner bolts  Type = gilt brass  brass  iron

other ..... Sample Ret.

Lid motifs

other ..... Sample Ret.

Escutcheons

other ..... Sample Ret.

Upholstery ~~nails~~

studs. brass  gilt brass  silvered brass  iron  Black. enamelled

other ..... = 1 piece; 13 studs + overleaf. Sample Ret.

Fixings

panel nails  screws  hinges  lace  Sample Ret.

Timber type .....

\* head plate has for studwork on REV - see following sheet.

Interpretation / Comments "Mast" John Davies/Aged 4 Years/1840

VI  
VII



| SITE                |  | COFFIN RECORD SHEET       |  | CONTEXT NO.                                                            |  |
|---------------------|--|---------------------------|--|------------------------------------------------------------------------|--|
| 07200               |  | Additional sheets: YES x2 |  | Treatment: INTACT<br>⇒ NECROP                                          |  |
| Trench:             |  | Grave fills               |  | Finds                                                                  |  |
| Site sub-div: CRYPT |  | Grave cut:                |  | None                                                                   |  |
| Plan no: 7          |  | Skeleton:                 |  | Breastplate ✓<br>Inscript. ①<br>Grip + head/foot plates.<br>outstreets |  |
| Section no:         |  | Matrix location: Bay 4.   |  | Hinge                                                                  |  |
| Co-ordinates:       |  | Preservation: 4           |  | Bracket                                                                |  |
| Levels              |  | Neg No:                   |  | Fixing nails                                                           |  |
| Slide No.           |  |                           |  | Shroud pins                                                            |  |
|                     |  |                           |  | Fabric                                                                 |  |
|                     |  |                           |  | Other finds                                                            |  |

Description: Sub delict p. b., W → E,

Discussion:

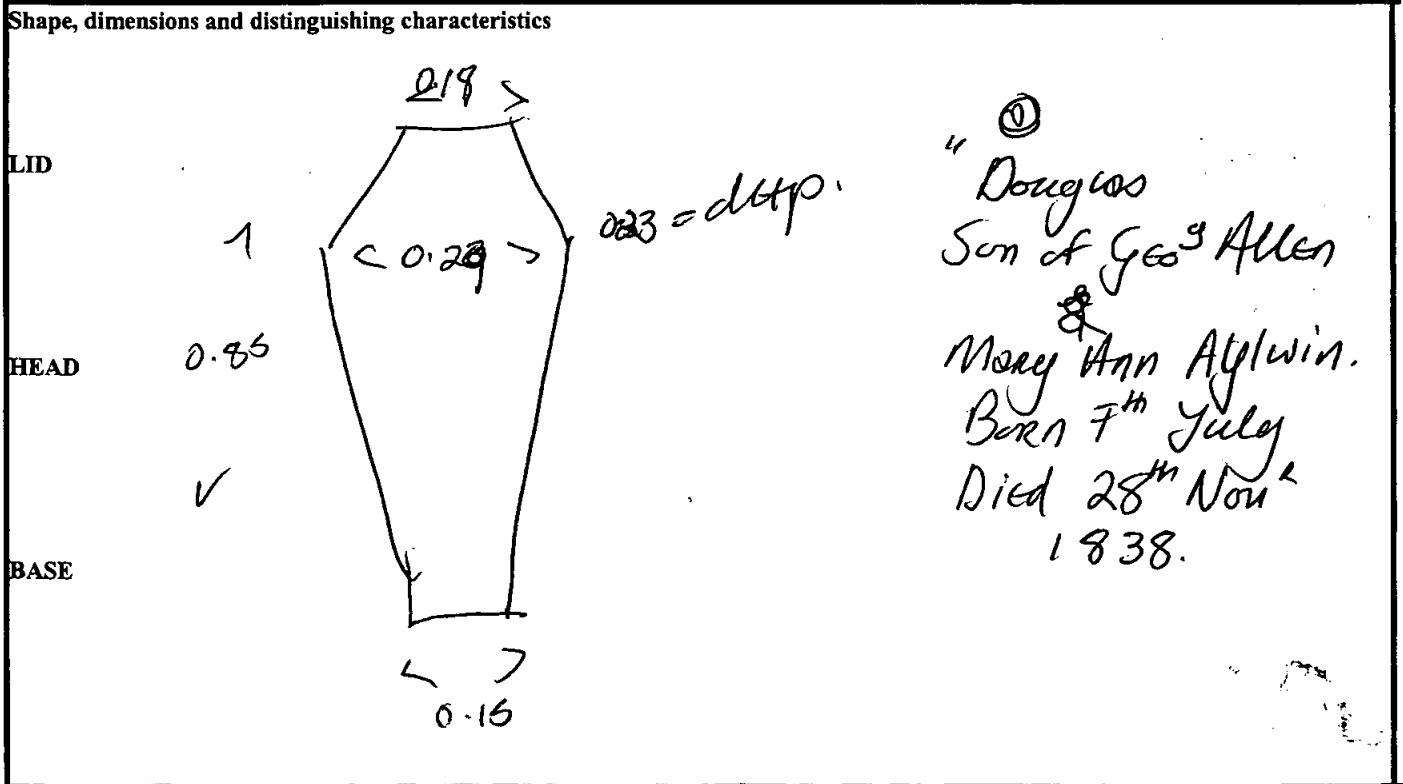

|              |             |           |
|--------------|-------------|-----------|
| Recorder: md | Date: 28/11 | Initials: |
|--------------|-------------|-----------|

Site Code

Context

Outer Coffin

Sample Ret.

OL100

1084

Recording Date ..... 28/11/00

Associated Numbers .....

Condition ..... 4

Dep. Plate

Legible

Inscription "Douglas/Son of George Allen/Mary Anne Aylwin/Born 2<sup>nd</sup> July/  
Died 28<sup>th</sup> Nov<sup>r</sup>/1838  
*\* + head/foot plate - plain ect.*

Fabric lead  ormolou  brass  tin plated pewter  gilt tin   
iron  silvered tin  enamelled  other ..... Sample Ret.

*infant dep. plate - new type (see sheet)*

Shape of dep. plate

square  rectangle  shield  tapered  lozenge   
cartouche  oval  other .....

Upholstery

colour ..... shoddy  velvet  other ..... Sample Ret.

Construction

butt joint  mitred  pitched  other .....

Grip plate  Fabric = ormolou  brass  tin plated pewter  gilt tin   
iron  silvered tin  enamelled  other ..... Sample Ret.

Grip  Fabric = ormolou  brass  iron  Sample Ret.

Design swag of rose  horseshoe  cherub's head  plain   
other .....

Grip bolts  Corner bolts  Type = gilt brass  brass  iron   
other ..... Sample Ret.

Lid motifs  other ..... Sample Ret.

Escutcheons  other ..... Sample Ret.

Upholstery nails  brass  gilt brass  silvered brass  iron  enamelled   
other ..... Sample Ret.

Fixings  panel nails  screws  hinges  lace  Sample Ret.

Timber type ..... Sample Ret.

Interpretation / Comments

*\* Douglas Aylwin Aylwin/1838.*

| SITE                       | COFFIN RECORD SHEET                   | CONTEXT NO.                                       |
|----------------------------|---------------------------------------|---------------------------------------------------|
| OLROS                      |                                       | 1085                                              |
| Trench:                    | Additional sheets:                    | Treatment:                                        |
| Site sub-div: <i>CRYPT</i> | Grave fills                           |                                                   |
| Plan no: <i>7</i>          | Grave cut:                            | Finds<br>None <input checked="" type="checkbox"/> |
| Section no:                | Skeleton:                             | Breastplate<br>Grip                               |
| Co-ordinates:              | Matrix location: <i>Bay 4 up 1081</i> | Hinge<br>Bracket                                  |
| Levels                     | Preservation: <i>w</i>                | Fixing nails<br>Shroud pins                       |
| Slide No.                  | Neg No:                               | Fabric<br>Other finds                             |

**Description** *infant p.b coffin, W → E, No ASME, lost,*

**Discussion**

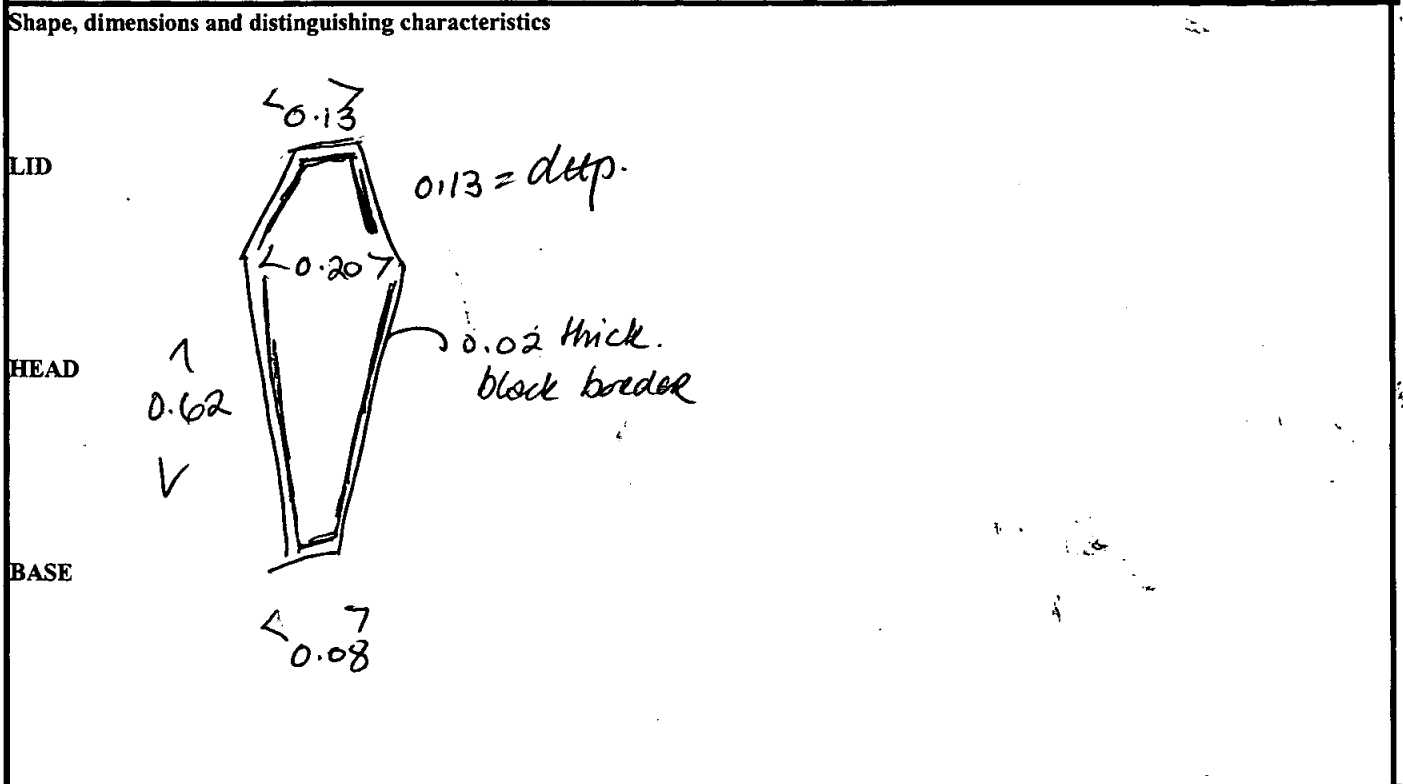

|                     |                    |           |
|---------------------|--------------------|-----------|
| Recorder: <i>Me</i> | Date: <i>28/11</i> | Initials: |
|---------------------|--------------------|-----------|

| SITE                | COFFIN RECORD SHEET                   | CONTEXT NO.                                                           |
|---------------------|---------------------------------------|-----------------------------------------------------------------------|
| OLR00               |                                       | 1086                                                                  |
| Trench:             | Additional sheets:                    | Treatment: BONES LIFTED,<br>DNA TAKEN, NO<br>TEETH                    |
| Site sub-div: CRYPT | Grave fills                           |                                                                       |
| Plan no: 7          | Grave cut:                            | Finds<br>None<br>Inscript. dir & border (C)                           |
| Section no:         | Skeleton:                             | Breastplate<br>Grip ✓ 1 x (A)                                         |
| Co-ordinates:       | Matrix location: Bay 4<br>adj to 1088 | Hinge<br>Bracket                                                      |
| Levels              | Preservation: 1                       | Fixing nails<br>Shroud pins x 3. studs in alloy on<br>foot end (1086) |
| Slide No.           | Neg No:                               | Fabric<br>Other finds                                                 |

**Description** adult p.b. coffin, S → N, body preserved, no teeth.

**Discussion**

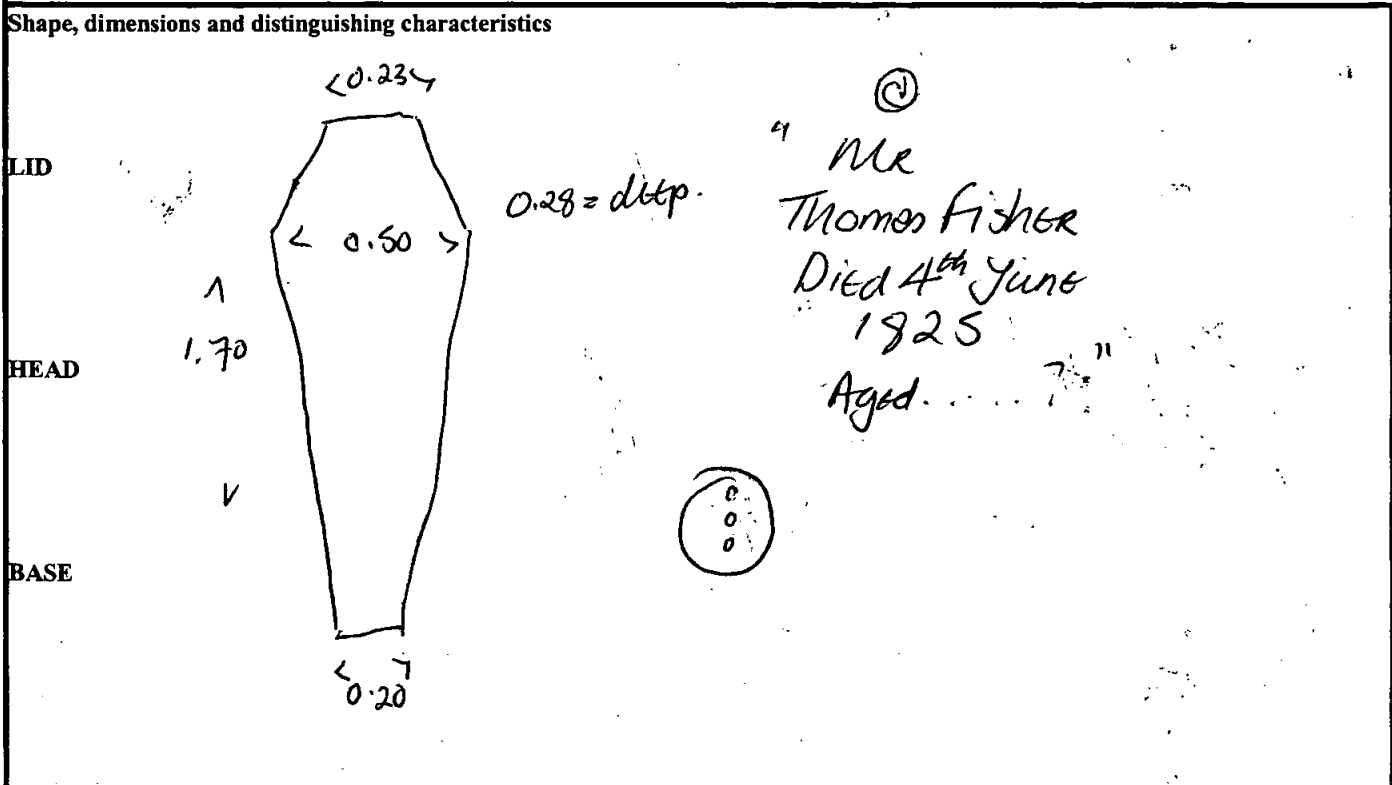

|           |       |           |
|-----------|-------|-----------|
| Recorder: | Date: | Initials: |
|-----------|-------|-----------|

| SITE                | COFFIN RECORD SHEET    | CONTEXT NO.                                                             |
|---------------------|------------------------|-------------------------------------------------------------------------|
| OR00                |                        | 1087                                                                    |
| Trench:             | Additional sheets:     | Treatment: <del>INSTALLED</del> BONES<br>KARAKORA LIFTED<br>& DNA TAKEN |
| Site sub-div: CAMPT | Grave fills:           |                                                                         |
| Plan no: 7          | Grave cut:             | Finds<br>None                                                           |
| Section no:         | Skeleton:              | Breastplate ✓ (20) cu alloy (20)<br>Inscript die & brod (20)<br>Grip    |
| Co-ordinates:       | Matrix location: Bay 4 | Hinge<br>Bracket                                                        |
| Levels:             | Preservation: 4        | Fixing nails<br>Shroud pins                                             |
| Slide No.:          | Neg No.:               | Fabric<br>Other finds                                                   |

Description: adult p.b. coffin, E → W

Discussion

Shape, dimensions and distinguishing characteristics

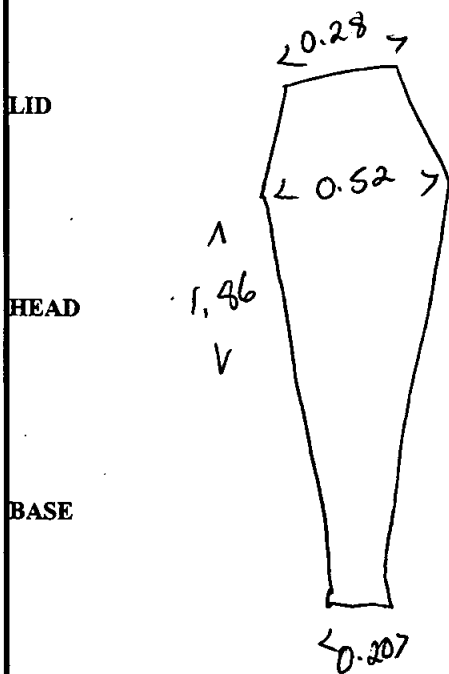

(20)  
 Mrs  
 Joan Wilson  
 Died 28<sup>th</sup> Oct<sup>R</sup>  
 1852  
 Aged 59 Years  
 (20)  
 Mrs  
 JOAN WILSON  
 DIED 28<sup>th</sup> OCT  
 1852  
 AGED 59 YEARS.

|           |       |           |
|-----------|-------|-----------|
| Recorder: | Date: | Initials: |
|-----------|-------|-----------|

| SITE               | COFFIN RECORD SHEET                  | CONTEXT NO.                                                                          |
|--------------------|--------------------------------------|--------------------------------------------------------------------------------------|
| 0200               |                                      | 1088                                                                                 |
| Trench:            | Additional sheets:                   | Treatment: BONES LIFTED<br>DNA TAKEN                                                 |
| Site sub-div: CAMP | Grave fills                          |                                                                                      |
| Plan no: 7         | Grave cut:                           | Finds                                                                                |
| Section no:        | Skeleton:                            | None<br>Foot plate ①<br>Breastplate ✓ bp ②<br>Inscription rest plate ③<br>Grip ✓ x 4 |
| Co-ordinates:      | Matrix location: Bay 4, edge to 1088 | Hinge                                                                                |
| Levels             | Preservation: 2                      | Bracket                                                                              |
| Slide No.          | Neg No:                              | Fixing nails<br>Studs & block<br>Shroud-pins                                         |
|                    |                                      | Fabric                                                                               |
|                    |                                      | Other finds                                                                          |

Description adult p.b. coffin, S → N,

Discussion

Shape, dimensions and distinguishing characteristics

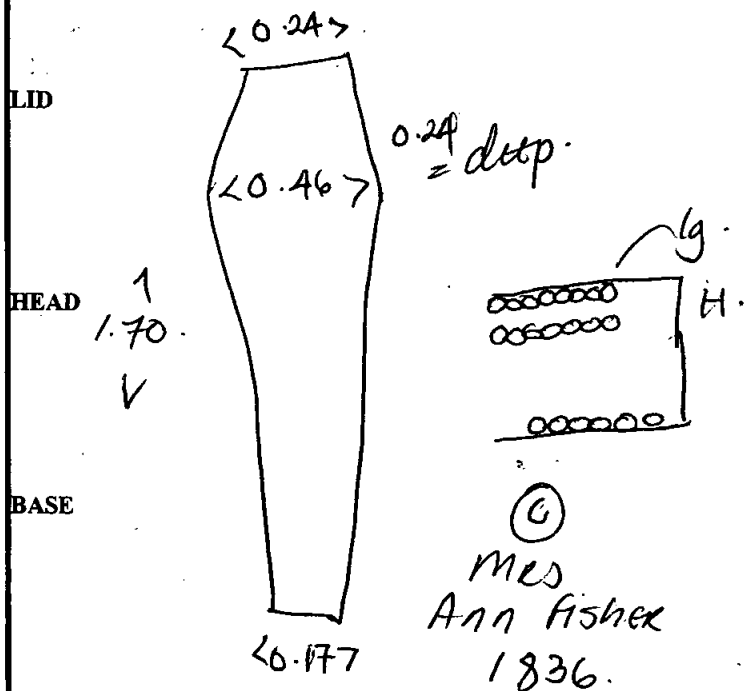

①  
" Ann Fisher  
Died 18<sup>th</sup> Dec<sup>r</sup>  
1836  
Aged 61 ~~years~~

②  
MES  
Ann Fisher  
Died 18<sup>th</sup> Dec<sup>r</sup>  
1836  
Aged 61 years

|           |       |           |
|-----------|-------|-----------|
| Recorder: | Date: | Initials: |
|-----------|-------|-----------|

Site Code

Context

Outer Coffin

Sample Ret.

ORCO

1088

Recording Date ..... 29/1/00 .....

Associated Numbers .....

Condition ..... 4 .....

Dep. Plate

Legible

Inscription "Mrs/Ann Fisher/Died 18<sup>th</sup> Dec<sup>r</sup>/1836/Aged 61"

Fabric lead  ormolou  brass  tin plated pewter  gilt tin   
iron  silvered tin  enamelled  other ..... Sample Ret.

② w/ diff outer border; see border sheet.

Shape of dep. plate

square  rectangle  shield  tapered  lozenge   
cartouche  oval  other .....

Upholstery  - textiles - frag. of knitted textile, stocking? fine knit.

colour ..... shoddy  velvet  other ..... Sample Ret.

Construction butt joint  mitred  pitched  other .....

Grip plate  Fabric = ormolou  brass  tin plated pewter  gilt tin   
iron  ⑥ silvered tin  enamelled  other ..... Sample Ret.

Grip  Fabric = ormolou  brass  iron  x4 ④ Sample Ret.

Design swag of rose  horseshoe  cherub's head  plain   
other .....

Grip bolts  Corner bolts  Type = gilt brass  brass  iron   
other ..... Sample Ret.

Lid motifs ?  other Fe. dec. plate, see following sheet. Sample Ret.

Escutcheons  other Fe. x1. ① Sample Ret.

Upholstery nails  brass  gilt brass  silvered brass  iron  enamelled   
other ..... Sample Ret.

Fixings  panel nails  screws  hinges  lace  Sample Ret.

Timber type ..... Sample Ret.

Interpretation / Comments

.....  
.....

Okroo

1088

Cont.

fe. det. plate.

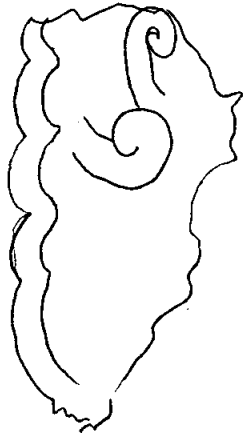

Scale 1:1.



| SITE                |  | COFFIN RECORD SHEET         |  | CONTEXT NO.                   |  |
|---------------------|--|-----------------------------|--|-------------------------------|--|
| 02200               |  | Additional sheets:          |  | 1089                          |  |
| Trench:             |  | Grave fills                 |  | Treatment: INTACT.            |  |
| Site sub-div: CRYPT |  | Grave cut:                  |  | → Neckst.                     |  |
| Plan no: 7          |  | Skeleton:                   |  | Finds: all furniture in alloy |  |
| Section no:         |  | Matrix location: Bay A      |  | Breastplate ✓ (20) (2)        |  |
| Co-ordinates:       |  | Preservation: 4             |  | Grip ✓ x 6 photos x 6.        |  |
| Levels:             |  | Neg No: Film 32 (negs 5-17) |  | Hinge                         |  |
| Slide No.:          |  |                             |  | Bracket                       |  |
|                     |  |                             |  | Fixing nails                  |  |
|                     |  |                             |  | Shroud pins                   |  |
|                     |  |                             |  | Fabric                        |  |
|                     |  |                             |  | Other finds                   |  |

**Description**  
 adult pb. coffin, W → E, outer wooden case largely intact in alloy studwork, brize upholstery. "pb coffin has black powder, c.o. 0.05 wide"

**Discussion**  
 Mrs Ann Luff  
 DIED 25th JULY 1847  
 AGED 78 YEARS"

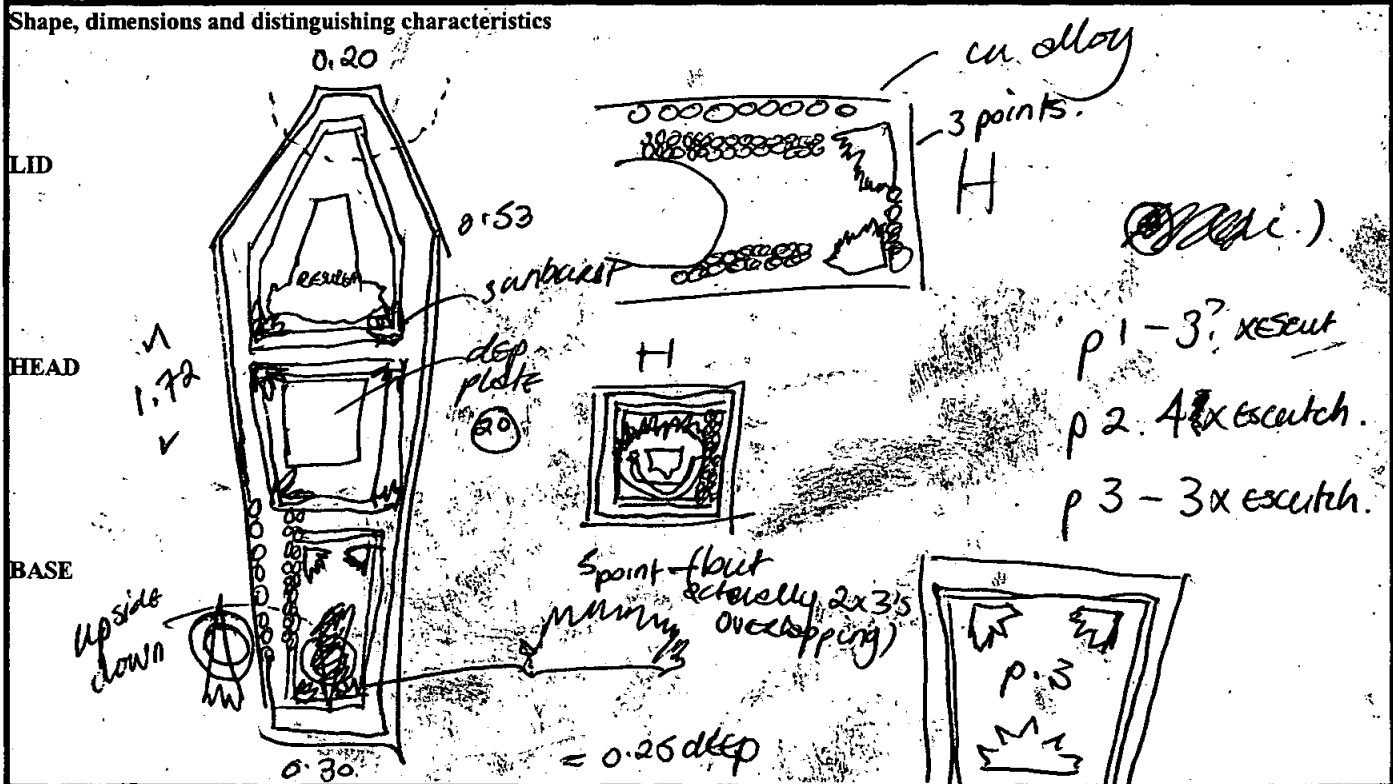

Recorder: Mcl Date: 3p/11 Initials:

Site Code

Context

**Outer Coffin**

Sample Ret.

0200

1089

Recording Date ..... 30/11/00 .....

Associated Numbers .....

Condition ..... A .....

Dep. Plate

Legible  *cu alloy (20)*

Inscription "Mrs Ann Ruff / DIED 25<sup>th</sup> JULY / 1847 / AGED 78 YEARS"

Fabric lead  ormolou  brass  tin plated pewter  gilt tin   
 iron  silvered tin  enamelled  other ..... Sample Ret.

**Shape of dep. plate**

square  rectangle  shield  tapered  lozenge   
 cartouche  oval  other .....

**Upholstery**

colour ..... shoddy  velvet  other ..... Sample Ret.

**Construction**

butt joint  mitred  pitched  other .....

Grip plate  Fabric = ormolou  brass  x 2 tin plated pewter  gilt tin   
 iron  silvered tin  enamelled  other ..... Sample Ret.   
*plate is a (25) w/ (14) scunbarot, new*

Grip  Fabric = ormolou  brass  x 2  iron  Sample Ret.   
*similar to (6) but new*

**Design**

swag of rose  horseshoe  cherub's head  plain

other .....

Grip bolts  Corner bolts  Type = gilt brass  brass  iron

other ..... Sample Ret.

Lid motifs 2 x  other 1x NEW Resurgam (similar to B) + 1 x (A) cu alloy. Sample Ret.

Escutcheons  other cu alloy (13)'s, many. Sample Ret.

Upholstery <sup>studs</sup> nails  brass  gilt brass  silvered brass  iron  enamelled

other ..... many, in situ, see sheet, top = (36b) Sample Ret.

Fixings  panel nails  screws  hinges  lace  Sample Ret.

Timber type ..... Sample Ret.

**Interpretation / Comments**

.....  
 .....

| SITE                |  | COFFIN RECORD SHEET         |  | CONTEXT NO.                                                       |  |
|---------------------|--|-----------------------------|--|-------------------------------------------------------------------|--|
| OR00                |  | Additional sheets: YES x 1. |  | 1090                                                              |  |
| Trench:             |  | Grave fills                 |  | Treatment: INTACT ⇒<br>NECROP                                     |  |
| Site sub-div: CRYPT |  | Grave cut:                  |  | Finds                                                             |  |
| Plan no: 7          |  | Skeleton:                   |  | None                                                              |  |
| Section no:         |  | Matrix location:            |  | Breastplate ✓ top (D)<br>Grip inscrip dir (E) = broad<br>foot (C) |  |
| Co-ordinates:       |  | Preservation:               |  | Hinge → 2 x (D)'s + plate<br>Bracket for studs,<br>fixing nails   |  |
| Levels              |  | Neg No:                     |  | Shroud pins                                                       |  |
| Slide No.           |  |                             |  | Fabric                                                            |  |
|                     |  |                             |  | Other finds                                                       |  |

Description adult pb coffin, intact,

Discussion

Shape, dimensions and distinguishing characteristics.

LID

HEAD

BASE

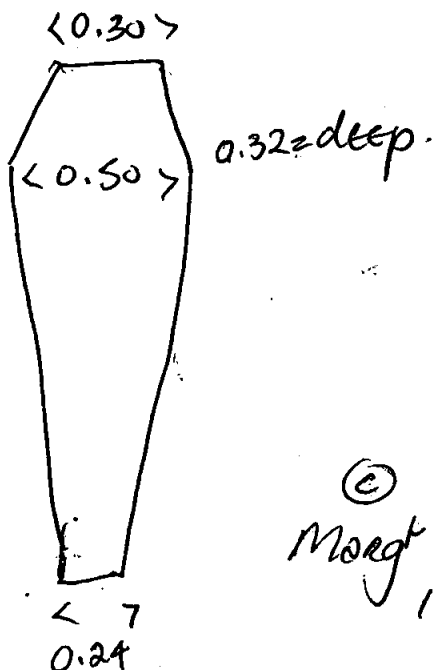

(D)  
Mr  
Margt Maxtin  
Died 22<sup>nd</sup> May  
1836  
Aged 40 years  
Mrs (E)  
Margaret Maxtin  
Died 22<sup>nd</sup> May  
1836  
Aged 40 years.

(C)  
Margt Maxtin  
1836.

(II)  
(VI)

Recorder:

Date:

Initials:

**Outer Coffin**

Sample Ret.

Site Code

Context

Recording Date ..... 4/12/00 .....

07200

1090

Associated Numbers .....

Condition ..... 2 .....

Dep. Plate

Legible

+ foot/head plate \*

Inscription "Mr<sup>s</sup>/Marg<sup>t</sup> Martin/Died 22<sup>nd</sup> May/1836/Aged 40 Years"

Fabric lead  ormolou  brass  tin plated pewter  gilt tin   
 iron  silvered tin  enamelled  other ..... Sample Ret.

(21) w/ 53A outer border.

**Shape of dep. plate**

square  rectangle  shield  tapered  lozenge   
 cartouche  oval  other .....

**Upholstery**

colour ..... shoddy  velvet  other ..... Sample Ret.

**Construction**

butt joint  mitred  pitched  other .....

**Grip plate**

Fabric = ormolou  brass  tin plated pewter  gilt tin

iron  silvered tin  enamelled  other ..... Sample Ret.

same as 1089, Fragmented, Black.

**Grip**

Fabric = ormolou  brass  iron  Sample Ret.

**Design**

swag of rose  horseshoe  cherub's head  plain

other .....

**Grip bolts**

**Corner bolts**  Type = gilt brass  brass  iron

other ..... Sample Ret.

**Lid motifs**

other ..... Sample Ret.

**Escutcheons**

other ..... Sample Ret.

**Upholstery nails**

brass  gilt brass  silvered brass  iron  enamelled

other ..... Sample Ret.

**Fixings**

panel nails  screws  hinges  lace  Sample Ret.

**Timber type**

Sample Ret.

**Interpretation / Comments**

\* Mr/Marg<sup>t</sup> Martin/1836. rest a board (11/11)

|               |                        |                                              |
|---------------|------------------------|----------------------------------------------|
| SITE<br>0200  | COFFIN RECORD SHEET    | CONTEXT NO.<br>1091                          |
| Trench:       | Additional sheets: 4x1 | Treatment: INTACT ⇒<br>NECROP                |
| Site sub-div: | Grave fills            |                                              |
| Plan no:      | Grave cut:             | Finds<br>None                                |
| Section no:   | Skeleton:              | Breastplate<br>Grip ✓ (36) [sketch] + plates |
| Co-ordinates: | Matrix location:       | Hinge<br>Bracket                             |
| Levels        | Preservation:          | Fixing nails<br>Shroud pins                  |
| Slide No.     | Neg No:                | Fabric<br>Other finds                        |

Description: skull pb coffin, intact,

Discussion:

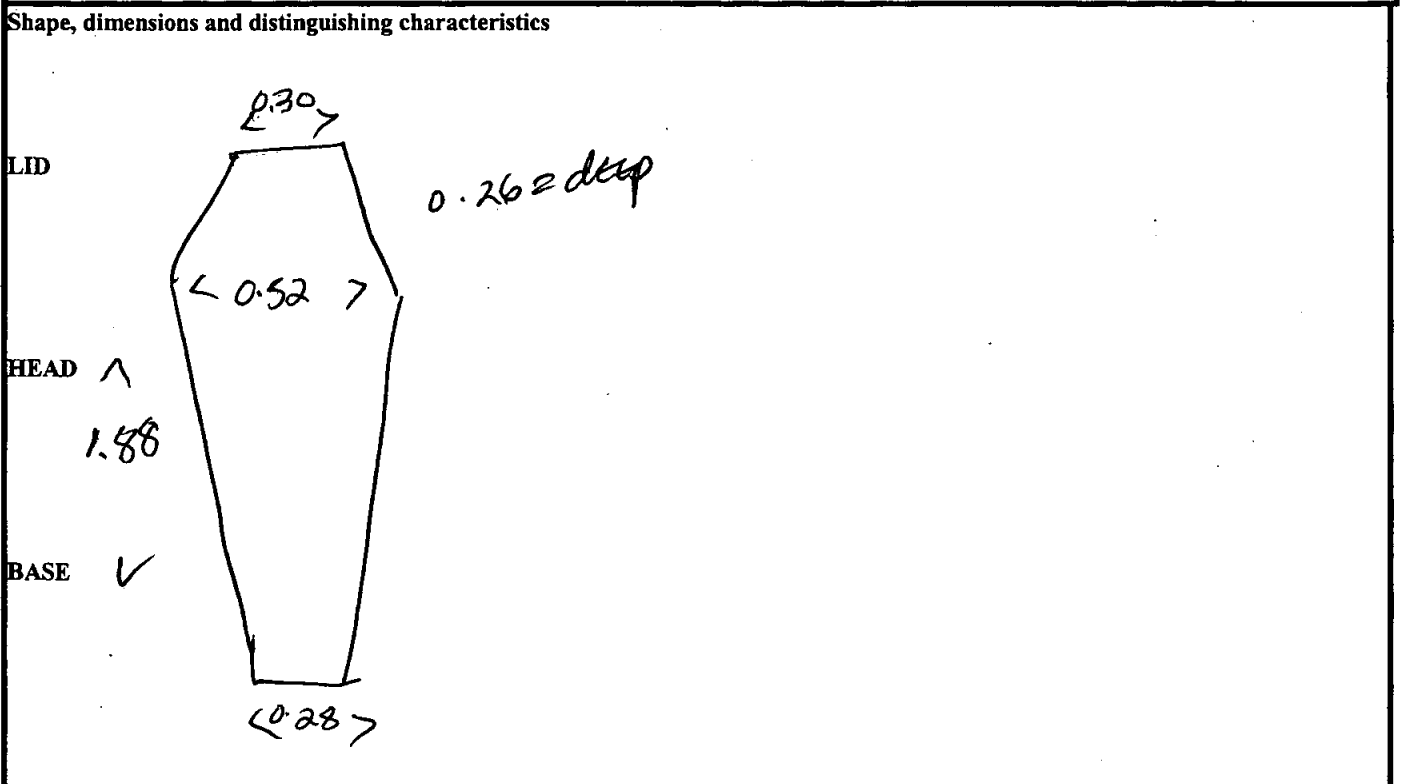

|           |       |           |
|-----------|-------|-----------|
| Recorder: | Date: | Initials: |
|-----------|-------|-----------|

# Coffin Recording Sheet

Site Code

Context

**Outer Coffin**

Sample Ret.

**02100**

**1091**

Recording Date ..... **1/12/00** .....

Associated Numbers .....

Condition .....

Dep. Plate

Legible

Inscription

Fabric lead  ormolou  brass  tin plated pewter  gilt tin   
 iron  silvered tin  enamelled  other ..... Sample Ret.

**Shape of dep. plate**

square  rectangle  shield  tapered  lozenge   
 cartouche  oval  other .....

**Upholstery**

colour ..... shoddy  velvet  other ..... Sample Ret.

**Construction**

butt joint  mitred  pitched  other .....

Grip plate  Fabric = ormolou  brass  tin plated pewter  gilt tin   
 iron  silvered tin  enamelled  other ..... Sample Ret.   
*frags on rev of grip - unid*

Grip  Fabric = ormolou  brass  iron  Sample Ret.   
*x1*

Design swag of rose  horseshoe  cherub's head  plain   
 other ..... **(36)**

Grip bolts  Corner bolts  Type = gilt brass  brass  iron   
 other ..... Sample Ret.

Lid motifs  other ..... Sample Ret.

Escutcheons  other ..... Sample Ret.

Upholstery nails  brass  gilt brass  silvered brass  iron  enamelled   
 other ..... Sample Ret.

Fixings  panel nails  screws  hinges  lace  Sample Ret.

Timber type ..... Sample Ret.

**Interpretation / Comments**

.....  
 .....

|                          |                                                |                                                                                                                                           |  |                         |
|--------------------------|------------------------------------------------|-------------------------------------------------------------------------------------------------------------------------------------------|--|-------------------------|
| SITE<br><b>OLROO</b>     |                                                | CONTEXT RECORD                                                                                                                            |  | Context No. <b>1092</b> |
| Trench                   |                                                | Additional Sheets:                                                                                                                        |  | Type <b>STRUCT</b>      |
| Site sub-div <b>SC</b>   | Context Type: Deposit / Cut / <b>Structure</b> | Check Lists:                                                                                                                              |  |                         |
| Structure No.            | Overlain by:                                   | DEPOSIT:                                                                                                                                  |  |                         |
| Plan No.                 | Abutted by: <b>1101</b>                        | 1.compaction 2.colour<br>3.composition<br>4.inclusions 5.thickness<br>6.extent 7.comments<br>8.method & conditions                        |  |                         |
| Section No.<br><b>14</b> | Cut by:                                        | CUT:                                                                                                                                      |  |                         |
|                          | Filled by:                                     | 1.shape in plan<br>2.base/sides/top profile<br>3.dimension and depth<br>4.sketch 5.truncation<br>6.fill nos 7.other comments              |  |                         |
| Co-Ordinates             | Same as:                                       | MASONRY:                                                                                                                                  |  |                         |
| Level                    | Part of:                                       | 1.materials 2.size of bricks etc 3.finish of stones 4.coursing/bond<br>5.form 6.faces 7.bond<br>8.dimensions as found<br>9.other comments |  |                         |
| Slide No.                | Consists of:                                   |                                                                                                                                           |  |                         |
| Neg No.                  | Overlies: <b>1093</b>                          |                                                                                                                                           |  |                         |
| Matrix location          | Butts:                                         |                                                                                                                                           |  |                         |
|                          | Cuts:                                          |                                                                                                                                           |  |                         |
|                          | Fill of:                                       |                                                                                                                                           |  |                         |
|                          | Relationships uncertain                        |                                                                                                                                           |  |                         |

Description (See check lists):

Concrete slab path 2.70m wide, 0.12m  
thick - runs N-S from old st to  
SE corner of church - bordered by a  
low brick/stone wall either side.  
Appears to be directly laid on

STRATIGRAPHIC MATRIX

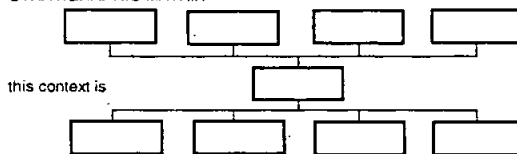

Interpretation/Discussion:

MODERN PATHWAY TO SE. DOOR OF CHURCH.

Finds (tick): None  Pot  Bone  Flint  Stone  Burnt stone  Glass  Metal   
CBM  Wood  Leather

△Small Finds

Recorder **DS**

◇Samples

Date **20/11**

△Building Materials

Initials

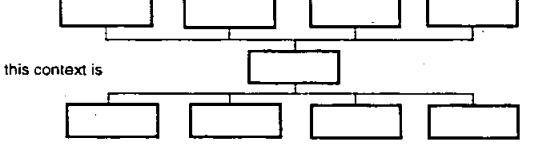
| SITE                                                                                                                                                                                                                                                                                                                                                                   | CONTEXT RECORD                                 |                                                                                                                                                              | Context No. <b>1094</b> |
|------------------------------------------------------------------------------------------------------------------------------------------------------------------------------------------------------------------------------------------------------------------------------------------------------------------------------------------------------------------------|------------------------------------------------|--------------------------------------------------------------------------------------------------------------------------------------------------------------|-------------------------|
| <b>OLR00</b>                                                                                                                                                                                                                                                                                                                                                           | Additional Sheets:                             |                                                                                                                                                              | Type <b>LAYER</b>       |
| Trench                                                                                                                                                                                                                                                                                                                                                                 | Context Type: <b>Deposit</b> / Cut / Structure |                                                                                                                                                              | Check Lists:            |
| Site sub-div <b>SC</b>                                                                                                                                                                                                                                                                                                                                                 | Overlain by: <b>1332</b>                       | <b>DEPOSIT:</b><br>1.compaction 2.colour<br>3.composition<br>4.inclusions 5.thickness<br>6.extent 7.comments<br>8.method & conditions                        |                         |
| Structure No.                                                                                                                                                                                                                                                                                                                                                          | Abutted by:                                    |                                                                                                                                                              |                         |
| Plan No.                                                                                                                                                                                                                                                                                                                                                               | Cut by:                                        |                                                                                                                                                              |                         |
| Section No. <b>14</b>                                                                                                                                                                                                                                                                                                                                                  | Filled by:                                     |                                                                                                                                                              |                         |
| Co-Ordinates                                                                                                                                                                                                                                                                                                                                                           | Same as:                                       | <b>CUT:</b><br>1.shape in plan<br>2.base/sides/top profile<br>3.dimension and depth<br>4.sketch 5.truncation<br>6.fill nos 7.other comments                  |                         |
| Level                                                                                                                                                                                                                                                                                                                                                                  | Part of:                                       |                                                                                                                                                              |                         |
| Slide No.                                                                                                                                                                                                                                                                                                                                                              | Consists of:                                   | <b>MASONRY:</b><br>1.materials 2.size of bricks etc 3.finish of stones 4.coursing/bond<br>5.form 6.faces 7.bond<br>8.dimensions as found<br>9.other comments |                         |
| Neg No.                                                                                                                                                                                                                                                                                                                                                                | Overlies: <b>1095</b>                          |                                                                                                                                                              |                         |
| Matrix location                                                                                                                                                                                                                                                                                                                                                        | Butts:                                         |                                                                                                                                                              |                         |
| Matrix location                                                                                                                                                                                                                                                                                                                                                        | Cuts:                                          |                                                                                                                                                              |                         |
| Matrix location                                                                                                                                                                                                                                                                                                                                                        | Fill of:                                       | Relationships uncertain                                                                                                                                      |                         |
| Description (See check lists):<br><i>mid greyish brown, friable sandy clay<br/>                 v' similar to 'topsoil' - underlying original?<br/>                 church path 1332 - prob' same as 102?<br/>                 c. 0.15m thick.</i>                                                                                                                     |                                                | STRATIGRAPHIC MATRIX<br>                                                  |                         |
| Interpretation/Discussion: <i>Burred topsoil.</i>                                                                                                                                                                                                                                                                                                                      |                                                |                                                                                                                                                              |                         |
| Finds (tick): None <input type="checkbox"/> Pot <input type="checkbox"/> Bone <input type="checkbox"/> Flint <input type="checkbox"/> Stone <input type="checkbox"/> Burnt stone <input type="checkbox"/> Glass <input type="checkbox"/> Metal <input type="checkbox"/><br>CBM <input type="checkbox"/> Wood <input type="checkbox"/> Leather <input type="checkbox"/> |                                                |                                                                                                                                                              |                         |
| ΔSmall Finds                                                                                                                                                                                                                                                                                                                                                           |                                                |                                                                                                                                                              | Recorder <b>DS</b>      |
| ◇Samples                                                                                                                                                                                                                                                                                                                                                               |                                                |                                                                                                                                                              | Date <b>20/11</b>       |
| ΔBuilding Materials                                                                                                                                                                                                                                                                                                                                                    |                                                |                                                                                                                                                              | Initials                |



| SITE                                                                                                                                                                                                                                                                                                                                                                   |                                                | CONTEXT RECORD                                                                                                                            |                    | Context No.              |
|------------------------------------------------------------------------------------------------------------------------------------------------------------------------------------------------------------------------------------------------------------------------------------------------------------------------------------------------------------------------|------------------------------------------------|-------------------------------------------------------------------------------------------------------------------------------------------|--------------------|--------------------------|
| OLR00                                                                                                                                                                                                                                                                                                                                                                  |                                                | Additional Sheets:                                                                                                                        |                    | 1095                     |
| Trench                                                                                                                                                                                                                                                                                                                                                                 | Context Type: <u>Deposit</u> / Cut / Structure |                                                                                                                                           |                    | Type <u>LAYER</u>        |
| Site sub-div <u>S.C.</u>                                                                                                                                                                                                                                                                                                                                               | Overlain by: <u>1014</u>                       | Check Lists:                                                                                                                              |                    |                          |
| Structure No.                                                                                                                                                                                                                                                                                                                                                          | Abutted by:                                    | DEPOSIT:                                                                                                                                  |                    |                          |
| Plan No.                                                                                                                                                                                                                                                                                                                                                               | Cut by:                                        | 1.compaction 2.colour<br>3.composition<br>4.inclusions 5.thickness<br>6.extent 7.comments<br>8.method & conditions                        |                    |                          |
| Section No. <u>14</u>                                                                                                                                                                                                                                                                                                                                                  | Filled by:                                     | CUT:                                                                                                                                      |                    |                          |
|                                                                                                                                                                                                                                                                                                                                                                        | Same as:                                       | 1.shape in plan<br>2.base/sides/top profile<br>3.dimension and depth<br>4.sketch 5.truncation<br>6.fill nos 7.other comments              |                    |                          |
| Co-Ordinates                                                                                                                                                                                                                                                                                                                                                           | Part of:                                       | MASONRY:                                                                                                                                  |                    |                          |
|                                                                                                                                                                                                                                                                                                                                                                        | Consists of:                                   | 1.materials 2.size of bricks etc 3.finish of stones 4.coursing/bond<br>5.form 6.faces 7.bond<br>8.dimensions as found<br>9.other comments |                    |                          |
| Level                                                                                                                                                                                                                                                                                                                                                                  | Overlies: <u>1096</u>                          | Butts:                                                                                                                                    |                    |                          |
| Slide No.                                                                                                                                                                                                                                                                                                                                                              | Butts:                                         | Cuts:                                                                                                                                     |                    |                          |
| Neg No.                                                                                                                                                                                                                                                                                                                                                                | Cuts:                                          | Fill of:                                                                                                                                  |                    |                          |
| Matrix location                                                                                                                                                                                                                                                                                                                                                        | Relationships uncertain                        |                                                                                                                                           |                    |                          |
| Description (See check lists):                                                                                                                                                                                                                                                                                                                                         |                                                |                                                                                                                                           |                    | STRATIGRAPHIC MATRIX<br> |
| Gravel lense 100' related to path<br>make up or an early pathway itself.<br>0.5m thick, 1.70m wide                                                                                                                                                                                                                                                                     |                                                |                                                                                                                                           |                    |                          |
|                                                                                                                                                                                                                                                                                                                                                                        |                                                |                                                                                                                                           |                    |                          |
|                                                                                                                                                                                                                                                                                                                                                                        |                                                |                                                                                                                                           |                    |                          |
|                                                                                                                                                                                                                                                                                                                                                                        |                                                |                                                                                                                                           |                    |                          |
| Interpretation/Discussion:                                                                                                                                                                                                                                                                                                                                             |                                                |                                                                                                                                           |                    |                          |
| gravel make up or early path.                                                                                                                                                                                                                                                                                                                                          |                                                |                                                                                                                                           |                    |                          |
|                                                                                                                                                                                                                                                                                                                                                                        |                                                |                                                                                                                                           |                    |                          |
|                                                                                                                                                                                                                                                                                                                                                                        |                                                |                                                                                                                                           |                    |                          |
|                                                                                                                                                                                                                                                                                                                                                                        |                                                |                                                                                                                                           |                    |                          |
|                                                                                                                                                                                                                                                                                                                                                                        |                                                |                                                                                                                                           |                    |                          |
|                                                                                                                                                                                                                                                                                                                                                                        |                                                |                                                                                                                                           |                    |                          |
|                                                                                                                                                                                                                                                                                                                                                                        |                                                |                                                                                                                                           |                    |                          |
| Finds (tick): None <input type="checkbox"/> Pot <input type="checkbox"/> Bone <input type="checkbox"/> Flint <input type="checkbox"/> Stone <input type="checkbox"/> Burnt stone <input type="checkbox"/> Glass <input type="checkbox"/> Metal <input type="checkbox"/><br>CBM <input type="checkbox"/> Wood <input type="checkbox"/> Leather <input type="checkbox"/> |                                                |                                                                                                                                           |                    |                          |
| ΔSmall Finds                                                                                                                                                                                                                                                                                                                                                           |                                                |                                                                                                                                           | Recorder <u>DS</u> |                          |
| ◇Samples                                                                                                                                                                                                                                                                                                                                                               |                                                |                                                                                                                                           | Date <u>20/11</u>  |                          |
| △Building Materials                                                                                                                                                                                                                                                                                                                                                    |                                                |                                                                                                                                           | Initials           |                          |

Oxford Archaeological Unit

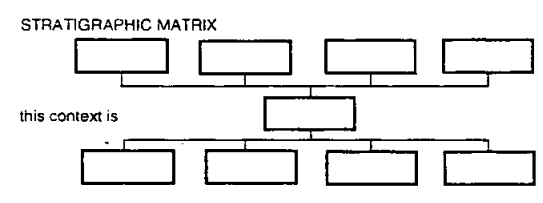
|                                                                                                                                                                                                                                                                                                                                                                     |                                                |                                                                                                                                           |                    |                         |
|---------------------------------------------------------------------------------------------------------------------------------------------------------------------------------------------------------------------------------------------------------------------------------------------------------------------------------------------------------------------|------------------------------------------------|-------------------------------------------------------------------------------------------------------------------------------------------|--------------------|-------------------------|
| SITE<br><i>OLR 00</i>                                                                                                                                                                                                                                                                                                                                               |                                                | CONTEXT RECORD                                                                                                                            |                    | Context No. <i>1096</i> |
| Additional Sheets:                                                                                                                                                                                                                                                                                                                                                  |                                                | Type <i>LAYER</i>                                                                                                                         |                    |                         |
| Trench                                                                                                                                                                                                                                                                                                                                                              | Context Type: <i>Deposit / Cut / Structure</i> |                                                                                                                                           | Check Lists:       |                         |
| Site sub-div <i>SC</i>                                                                                                                                                                                                                                                                                                                                              | Overlain by: <i>1095</i>                       | DEPOSIT:                                                                                                                                  |                    |                         |
| Structure No.                                                                                                                                                                                                                                                                                                                                                       | Abutted by:                                    | 1.compaction 2.colour<br>3.composition<br>4.inclusions 5.thickness<br>6.extend 7.comments<br>8.method & conditions                        |                    |                         |
| Plan No.                                                                                                                                                                                                                                                                                                                                                            | Cut by:                                        | CUT:                                                                                                                                      |                    |                         |
|                                                                                                                                                                                                                                                                                                                                                                     | Filled by:                                     | 1.shape in plan<br>2.base/sides/top profile<br>3.dimension and depth<br>4.sketch 5.truncation<br>6.fill nos 7.other comments              |                    |                         |
| Section No. <i>14</i>                                                                                                                                                                                                                                                                                                                                               | Same as:                                       | MASONRY:                                                                                                                                  |                    |                         |
|                                                                                                                                                                                                                                                                                                                                                                     | Part of:                                       | 1.materials 2.size of bricks etc 3.finish of stones 4.coursing/bond<br>5.form 6.faces 7.bond<br>8.dimensions as found<br>9.other comments |                    |                         |
| Co-Ordinates                                                                                                                                                                                                                                                                                                                                                        | Consists of:                                   |                                                                                                                                           |                    |                         |
|                                                                                                                                                                                                                                                                                                                                                                     | Overlies: <i>1097</i>                          |                                                                                                                                           |                    |                         |
| Level                                                                                                                                                                                                                                                                                                                                                               | Butts:                                         |                                                                                                                                           |                    |                         |
| Slide No.                                                                                                                                                                                                                                                                                                                                                           | Cuts:                                          |                                                                                                                                           |                    |                         |
| Neg No.                                                                                                                                                                                                                                                                                                                                                             | Fill of:                                       |                                                                                                                                           |                    |                         |
| Matrix location                                                                                                                                                                                                                                                                                                                                                     | Relationships uncertain                        |                                                                                                                                           |                    |                         |
| Description (See check lists):<br><i>loose</i><br><i>Rubble / CBM / gravel etc. 0.40m thick.</i>                                                                                                                                                                                                                                                                    |                                                | STRATIGRAPHIC MATRIX<br>                               |                    |                         |
| Interpretation/Discussion:<br><i>made gravel - possible demolition material from old st fontage prior to church construction?</i>                                                                                                                                                                                                                                   |                                                |                                                                                                                                           |                    |                         |
| Finds (tick): None <input type="checkbox"/> Pot <input type="checkbox"/> Bone <input type="checkbox"/> Flint <input type="checkbox"/> Stone <input type="checkbox"/> Burnt stone <input type="checkbox"/> Glass <input type="checkbox"/> Metal <input type="checkbox"/> CBM <input type="checkbox"/> Wood <input type="checkbox"/> Leather <input type="checkbox"/> |                                                |                                                                                                                                           |                    |                         |
| ΔSmall Finds                                                                                                                                                                                                                                                                                                                                                        |                                                |                                                                                                                                           | Recorder <i>DS</i> |                         |
| ◇Samples                                                                                                                                                                                                                                                                                                                                                            |                                                |                                                                                                                                           | Date <i>20/11</i>  |                         |
| △Building Materials                                                                                                                                                                                                                                                                                                                                                 |                                                |                                                                                                                                           | Initials           |                         |

Oxford Archaeological Unit

| SITE                                                                                                                                                                                                                                                                                                                                                                           |                                         | CONTEXT RECORD                                     |             | Context No.                                                                                                                                     |
|--------------------------------------------------------------------------------------------------------------------------------------------------------------------------------------------------------------------------------------------------------------------------------------------------------------------------------------------------------------------------------|-----------------------------------------|----------------------------------------------------|-------------|-------------------------------------------------------------------------------------------------------------------------------------------------|
| OLR00                                                                                                                                                                                                                                                                                                                                                                          |                                         | Additional Sheets:                                 |             | 1097                                                                                                                                            |
| Trench                                                                                                                                                                                                                                                                                                                                                                         | Context Type: Deposit / Cut / Structure |                                                    |             | Type LAYER                                                                                                                                      |
| Site sub-div                                                                                                                                                                                                                                                                                                                                                                   | SC.                                     | Overlain by:                                       | (1096)      | Check Lists:                                                                                                                                    |
| Structure No.                                                                                                                                                                                                                                                                                                                                                                  |                                         | Abutted by:                                        |             | DEPOSIT:                                                                                                                                        |
| Plan No.                                                                                                                                                                                                                                                                                                                                                                       |                                         | Cut by:                                            |             | 1.compaction 2.colour<br>3.composition<br>4.inclusions 5.thickness<br>6.extent 7.comments<br>8.method & conditions                              |
|                                                                                                                                                                                                                                                                                                                                                                                |                                         | Filled by:                                         |             | CUT:                                                                                                                                            |
| Section No.                                                                                                                                                                                                                                                                                                                                                                    | 14                                      | Same as:                                           |             | 1.shape in plan<br>2.base/sides/top profile<br>3.dimension and depth<br>4.sketch 5.truncation<br>6.fill nos 7.other<br>comments                 |
| Co-Ordinates                                                                                                                                                                                                                                                                                                                                                                   |                                         | Part of:                                           |             | MASONRY:                                                                                                                                        |
|                                                                                                                                                                                                                                                                                                                                                                                |                                         | Consists of:                                       |             | 1.materials 2.size of<br>bricks etc 3.finish of<br>stones 4.coursing/bond<br>5.form 6.faces 7.bond<br>8.dimensions as found<br>9.other comments |
| Level                                                                                                                                                                                                                                                                                                                                                                          |                                         | Overlies:                                          | (1098)      |                                                                                                                                                 |
| Slide No.                                                                                                                                                                                                                                                                                                                                                                      |                                         | Butts:                                             |             |                                                                                                                                                 |
| Neg No.                                                                                                                                                                                                                                                                                                                                                                        |                                         | Cuts:                                              |             |                                                                                                                                                 |
| Matrix location                                                                                                                                                                                                                                                                                                                                                                |                                         | Fill of:                                           |             |                                                                                                                                                 |
| Description (See check lists):                                                                                                                                                                                                                                                                                                                                                 |                                         | Relationships uncertain                            |             |                                                                                                                                                 |
| <p>frimble sandy clay with additional<br/>lenses of sand to clay<br/>0.30m thick.</p>                                                                                                                                                                                                                                                                                          |                                         | <p>STRATIGRAPHIC MATRIX</p> <p>this context is</p> |             |                                                                                                                                                 |
| Interpretation/Discussion:                                                                                                                                                                                                                                                                                                                                                     |                                         | made ground (post med)                             |             |                                                                                                                                                 |
| <p>Finds (tick): None <input type="checkbox"/> Pot <input type="checkbox"/> Bone <input type="checkbox"/> Flint <input type="checkbox"/> Stone <input type="checkbox"/> Burnt stone <input type="checkbox"/> Glass <input type="checkbox"/> Metal <input type="checkbox"/><br/>CBM <input type="checkbox"/> Wood <input type="checkbox"/> Leather <input type="checkbox"/></p> |                                         |                                                    |             |                                                                                                                                                 |
| ΔSmall Finds                                                                                                                                                                                                                                                                                                                                                                   |                                         |                                                    | Recorder DS |                                                                                                                                                 |
| ◇Samples                                                                                                                                                                                                                                                                                                                                                                       |                                         |                                                    | Date 20/11  |                                                                                                                                                 |
| △Building Materials                                                                                                                                                                                                                                                                                                                                                            |                                         |                                                    | Initials    |                                                                                                                                                 |

Oxford Archaeological Unit

| SITE                                                                                               |                                              | CONTEXT RECORD                                                                                                                                                                                                                                                                                                                                                                                                                                                                                                                                                                                                                                                                                                                                                                                                                                                                                                                                                                                                                                                                                                                                                                                                                                                                                                                                                                                                                                                                                                                                                                                                                                                                                                                                                                                                                                                                                                                                                                        |                   | Context No. |  |  |
|----------------------------------------------------------------------------------------------------|----------------------------------------------|---------------------------------------------------------------------------------------------------------------------------------------------------------------------------------------------------------------------------------------------------------------------------------------------------------------------------------------------------------------------------------------------------------------------------------------------------------------------------------------------------------------------------------------------------------------------------------------------------------------------------------------------------------------------------------------------------------------------------------------------------------------------------------------------------------------------------------------------------------------------------------------------------------------------------------------------------------------------------------------------------------------------------------------------------------------------------------------------------------------------------------------------------------------------------------------------------------------------------------------------------------------------------------------------------------------------------------------------------------------------------------------------------------------------------------------------------------------------------------------------------------------------------------------------------------------------------------------------------------------------------------------------------------------------------------------------------------------------------------------------------------------------------------------------------------------------------------------------------------------------------------------------------------------------------------------------------------------------------------------|-------------------|-------------|--|--|
| OLR00                                                                                              |                                              | Additional Sheets:                                                                                                                                                                                                                                                                                                                                                                                                                                                                                                                                                                                                                                                                                                                                                                                                                                                                                                                                                                                                                                                                                                                                                                                                                                                                                                                                                                                                                                                                                                                                                                                                                                                                                                                                                                                                                                                                                                                                                                    |                   | 1098        |  |  |
| Trench                                                                                             | Context Type: <u>Deposit</u> Cut / Structure |                                                                                                                                                                                                                                                                                                                                                                                                                                                                                                                                                                                                                                                                                                                                                                                                                                                                                                                                                                                                                                                                                                                                                                                                                                                                                                                                                                                                                                                                                                                                                                                                                                                                                                                                                                                                                                                                                                                                                                                       | Type <u>LAYER</u> |             |  |  |
| Site sub-div <u>SC.</u>                                                                            | Overlain by: <u>1097</u>                     | Check Lists:                                                                                                                                                                                                                                                                                                                                                                                                                                                                                                                                                                                                                                                                                                                                                                                                                                                                                                                                                                                                                                                                                                                                                                                                                                                                                                                                                                                                                                                                                                                                                                                                                                                                                                                                                                                                                                                                                                                                                                          |                   |             |  |  |
| Structure No.                                                                                      | Abutted by:                                  | DEPOSIT:                                                                                                                                                                                                                                                                                                                                                                                                                                                                                                                                                                                                                                                                                                                                                                                                                                                                                                                                                                                                                                                                                                                                                                                                                                                                                                                                                                                                                                                                                                                                                                                                                                                                                                                                                                                                                                                                                                                                                                              |                   |             |  |  |
| Plan No.                                                                                           | Cut by:                                      | 1.compaction 2.colour<br>3.composition<br>4.inclusions 5.thickness<br>6.extent 7.comments<br>8.method & conditions                                                                                                                                                                                                                                                                                                                                                                                                                                                                                                                                                                                                                                                                                                                                                                                                                                                                                                                                                                                                                                                                                                                                                                                                                                                                                                                                                                                                                                                                                                                                                                                                                                                                                                                                                                                                                                                                    |                   |             |  |  |
| Section No. <u>14</u>                                                                              | Filled by:                                   | CUT:                                                                                                                                                                                                                                                                                                                                                                                                                                                                                                                                                                                                                                                                                                                                                                                                                                                                                                                                                                                                                                                                                                                                                                                                                                                                                                                                                                                                                                                                                                                                                                                                                                                                                                                                                                                                                                                                                                                                                                                  |                   |             |  |  |
|                                                                                                    | Same as:                                     | 1.shape in plan<br>2.base/sides/top profile<br>3.dimension and depth<br>4.sketch 5.function<br>6.fill nos 7.other comments                                                                                                                                                                                                                                                                                                                                                                                                                                                                                                                                                                                                                                                                                                                                                                                                                                                                                                                                                                                                                                                                                                                                                                                                                                                                                                                                                                                                                                                                                                                                                                                                                                                                                                                                                                                                                                                            |                   |             |  |  |
| Co-Ordinates                                                                                       | Part of:                                     | MASONRY:                                                                                                                                                                                                                                                                                                                                                                                                                                                                                                                                                                                                                                                                                                                                                                                                                                                                                                                                                                                                                                                                                                                                                                                                                                                                                                                                                                                                                                                                                                                                                                                                                                                                                                                                                                                                                                                                                                                                                                              |                   |             |  |  |
|                                                                                                    | Consists of:                                 | 1.materials 2.size of bricks etc 3.finish of stones 4.coursing/bond<br>5.form 6.faces 7.bond<br>8.dimensions as found<br>9.other comments                                                                                                                                                                                                                                                                                                                                                                                                                                                                                                                                                                                                                                                                                                                                                                                                                                                                                                                                                                                                                                                                                                                                                                                                                                                                                                                                                                                                                                                                                                                                                                                                                                                                                                                                                                                                                                             |                   |             |  |  |
| Level                                                                                              | Overlies: <u>1099</u>                        | Butts:                                                                                                                                                                                                                                                                                                                                                                                                                                                                                                                                                                                                                                                                                                                                                                                                                                                                                                                                                                                                                                                                                                                                                                                                                                                                                                                                                                                                                                                                                                                                                                                                                                                                                                                                                                                                                                                                                                                                                                                |                   |             |  |  |
| Slide No.                                                                                          | Butts:                                       | Cuts:                                                                                                                                                                                                                                                                                                                                                                                                                                                                                                                                                                                                                                                                                                                                                                                                                                                                                                                                                                                                                                                                                                                                                                                                                                                                                                                                                                                                                                                                                                                                                                                                                                                                                                                                                                                                                                                                                                                                                                                 |                   |             |  |  |
| Neg No.                                                                                            | Cuts:                                        | Fill of:                                                                                                                                                                                                                                                                                                                                                                                                                                                                                                                                                                                                                                                                                                                                                                                                                                                                                                                                                                                                                                                                                                                                                                                                                                                                                                                                                                                                                                                                                                                                                                                                                                                                                                                                                                                                                                                                                                                                                                              |                   |             |  |  |
| Matrix location                                                                                    | Relationships uncertain                      |                                                                                                                                                                                                                                                                                                                                                                                                                                                                                                                                                                                                                                                                                                                                                                                                                                                                                                                                                                                                                                                                                                                                                                                                                                                                                                                                                                                                                                                                                                                                                                                                                                                                                                                                                                                                                                                                                                                                                                                       |                   |             |  |  |
| Description (See check lists):                                                                     |                                              | STRATIGRAPHIC MATRIX                                                                                                                                                                                                                                                                                                                                                                                                                                                                                                                                                                                                                                                                                                                                                                                                                                                                                                                                                                                                                                                                                                                                                                                                                                                                                                                                                                                                                                                                                                                                                                                                                                                                                                                                                                                                                                                                                                                                                                  |                   |             |  |  |
| <p><i>Friable mid brown sandy clay with<br/>cbm/shell/bone + ash lenses.<br/>c. 0.5m thick</i></p> |                                              | <pre> graph TD     C1[ ] --- C2[ ]     C2 --- C3[ ]     C3 --- C4[ ]     C4 --- C5[ ]     C5 --- C6[ ]     C6 --- C7[ ]     C7 --- C8[ ]     C8 --- C9[ ]     C9 --- C10[ ]     C10 --- C11[ ]     C11 --- C12[ ]     C12 --- C13[ ]     C13 --- C14[ ]     C14 --- C15[ ]     C15 --- C16[ ]     C16 --- C17[ ]     C17 --- C18[ ]     C18 --- C19[ ]     C19 --- C20[ ]     C20 --- C21[ ]     C21 --- C22[ ]     C22 --- C23[ ]     C23 --- C24[ ]     C24 --- C25[ ]     C25 --- C26[ ]     C26 --- C27[ ]     C27 --- C28[ ]     C28 --- C29[ ]     C29 --- C30[ ]     C30 --- C31[ ]     C31 --- C32[ ]     C32 --- C33[ ]     C33 --- C34[ ]     C34 --- C35[ ]     C35 --- C36[ ]     C36 --- C37[ ]     C37 --- C38[ ]     C38 --- C39[ ]     C39 --- C40[ ]     C40 --- C41[ ]     C41 --- C42[ ]     C42 --- C43[ ]     C43 --- C44[ ]     C44 --- C45[ ]     C45 --- C46[ ]     C46 --- C47[ ]     C47 --- C48[ ]     C48 --- C49[ ]     C49 --- C50[ ]     C50 --- C51[ ]     C51 --- C52[ ]     C52 --- C53[ ]     C53 --- C54[ ]     C54 --- C55[ ]     C55 --- C56[ ]     C56 --- C57[ ]     C57 --- C58[ ]     C58 --- C59[ ]     C59 --- C60[ ]     C60 --- C61[ ]     C61 --- C62[ ]     C62 --- C63[ ]     C63 --- C64[ ]     C64 --- C65[ ]     C65 --- C66[ ]     C66 --- C67[ ]     C67 --- C68[ ]     C68 --- C69[ ]     C69 --- C70[ ]     C70 --- C71[ ]     C71 --- C72[ ]     C72 --- C73[ ]     C73 --- C74[ ]     C74 --- C75[ ]     C75 --- C76[ ]     C76 --- C77[ ]     C77 --- C78[ ]     C78 --- C79[ ]     C79 --- C80[ ]     C80 --- C81[ ]     C81 --- C82[ ]     C82 --- C83[ ]     C83 --- C84[ ]     C84 --- C85[ ]     C85 --- C86[ ]     C86 --- C87[ ]     C87 --- C88[ ]     C88 --- C89[ ]     C89 --- C90[ ]     C90 --- C91[ ]     C91 --- C92[ ]     C92 --- C93[ ]     C93 --- C94[ ]     C94 --- C95[ ]     C95 --- C96[ ]     C96 --- C97[ ]     C97 --- C98[ ]     C98 --- C99[ ]     C99 --- C100[ ]                     </pre> |                   |             |  |  |
|                                                                                                    |                                              | Interpretation/Discussion: <u>(Pimed) Dumping/waste ground</u>                                                                                                                                                                                                                                                                                                                                                                                                                                                                                                                                                                                                                                                                                                                                                                                                                                                                                                                                                                                                                                                                                                                                                                                                                                                                                                                                                                                                                                                                                                                                                                                                                                                                                                                                                                                                                                                                                                                        |                   |             |  |  |
|                                                                                                    |                                              | Finds (tick): None <input type="checkbox"/> Pot <input type="checkbox"/> Bone <input type="checkbox"/> Flint <input type="checkbox"/> Stone <input type="checkbox"/> Burnt stone <input type="checkbox"/> Glass <input type="checkbox"/> Metal <input type="checkbox"/><br>CBM <input type="checkbox"/> Wood <input type="checkbox"/> Leather <input type="checkbox"/>                                                                                                                                                                                                                                                                                                                                                                                                                                                                                                                                                                                                                                                                                                                                                                                                                                                                                                                                                                                                                                                                                                                                                                                                                                                                                                                                                                                                                                                                                                                                                                                                                |                   |             |  |  |
|                                                                                                    |                                              | ΔSmall Finds                                                                                                                                                                                                                                                                                                                                                                                                                                                                                                                                                                                                                                                                                                                                                                                                                                                                                                                                                                                                                                                                                                                                                                                                                                                                                                                                                                                                                                                                                                                                                                                                                                                                                                                                                                                                                                                                                                                                                                          | Recorder          |             |  |  |
| ◇Samples                                                                                           | Date                                         |                                                                                                                                                                                                                                                                                                                                                                                                                                                                                                                                                                                                                                                                                                                                                                                                                                                                                                                                                                                                                                                                                                                                                                                                                                                                                                                                                                                                                                                                                                                                                                                                                                                                                                                                                                                                                                                                                                                                                                                       |                   |             |  |  |
| △Building Materials                                                                                | Initials                                     |                                                                                                                                                                                                                                                                                                                                                                                                                                                                                                                                                                                                                                                                                                                                                                                                                                                                                                                                                                                                                                                                                                                                                                                                                                                                                                                                                                                                                                                                                                                                                                                                                                                                                                                                                                                                                                                                                                                                                                                       |                   |             |  |  |

Oxford Archaeological Unit

|                                                                                                                                                                                                                                                                                                                                                                     |                                                |                                                                                                                                           |                    |                         |
|---------------------------------------------------------------------------------------------------------------------------------------------------------------------------------------------------------------------------------------------------------------------------------------------------------------------------------------------------------------------|------------------------------------------------|-------------------------------------------------------------------------------------------------------------------------------------------|--------------------|-------------------------|
| SITE<br><b>OL200</b>                                                                                                                                                                                                                                                                                                                                                |                                                | CONTEXT RECORD                                                                                                                            |                    | Context No. <b>1099</b> |
| Additional Sheets:                                                                                                                                                                                                                                                                                                                                                  |                                                | Type <b>LAYER</b>                                                                                                                         |                    |                         |
| Trench                                                                                                                                                                                                                                                                                                                                                              | Context Type: <b>Deposit</b> / Cut / Structure |                                                                                                                                           | Check Lists:       |                         |
| Site sub-div <b>SC</b>                                                                                                                                                                                                                                                                                                                                              | Overlain by: <b>1098</b>                       | DEPOSIT:                                                                                                                                  |                    |                         |
| Structure No.                                                                                                                                                                                                                                                                                                                                                       | Abuted by:                                     | 1.compaction 2.colour<br>3.composition<br>4.inclusions 5.thickness<br>6.extent 7.comments<br>8.method & conditions                        |                    |                         |
| Plan No.                                                                                                                                                                                                                                                                                                                                                            | Cut by:                                        | CUT:                                                                                                                                      |                    |                         |
|                                                                                                                                                                                                                                                                                                                                                                     | Filled by:                                     | 1.shape in plan<br>2.base/sides/top profile<br>3.dimension and depth<br>4.sketch 5.truncation<br>6.fill nos/7.other comments              |                    |                         |
| Section No.<br><b>14 / 19</b>                                                                                                                                                                                                                                                                                                                                       | Same as:                                       | MASONRY:                                                                                                                                  |                    |                         |
| Co-Ordinates                                                                                                                                                                                                                                                                                                                                                        | Part of:                                       | 1.materials 2.size of bricks etc 3.finish of stones 4.coursing/bond<br>5.form 6.faces 7.bond<br>8.dimensions as found<br>9.other comments |                    |                         |
| Level                                                                                                                                                                                                                                                                                                                                                               | Consists of:                                   |                                                                                                                                           |                    |                         |
| Slide No.                                                                                                                                                                                                                                                                                                                                                           | Overlies: <b>1100</b>                          |                                                                                                                                           |                    |                         |
| Neg No.                                                                                                                                                                                                                                                                                                                                                             | Butts:                                         |                                                                                                                                           |                    |                         |
| Matrix location                                                                                                                                                                                                                                                                                                                                                     | Cuts:                                          |                                                                                                                                           |                    |                         |
|                                                                                                                                                                                                                                                                                                                                                                     | Fill of:                                       |                                                                                                                                           |                    |                         |
|                                                                                                                                                                                                                                                                                                                                                                     | Relationships uncertain                        |                                                                                                                                           |                    |                         |
| Description (See check lists):                                                                                                                                                                                                                                                                                                                                      |                                                | STRATIGRAPHIC MATRIX                                                                                                                      |                    |                         |
| <b>Friable - mid brown sandy clay, cbm, mortar chips, bone/shell/ash.</b>                                                                                                                                                                                                                                                                                           |                                                |                                                                                                                                           |                    |                         |
| Interpretation/Discussion:                                                                                                                                                                                                                                                                                                                                          |                                                |                                                                                                                                           |                    |                         |
| <b>Primed made ground.</b>                                                                                                                                                                                                                                                                                                                                          |                                                |                                                                                                                                           |                    |                         |
| Finds (tick): None <input type="checkbox"/> Pot <input type="checkbox"/> Bone <input type="checkbox"/> Flint <input type="checkbox"/> Stone <input type="checkbox"/> Burnt stone <input type="checkbox"/> Glass <input type="checkbox"/> Metal <input type="checkbox"/> CBM <input type="checkbox"/> Wood <input type="checkbox"/> Leather <input type="checkbox"/> |                                                |                                                                                                                                           |                    |                         |
| ΔSmall Finds                                                                                                                                                                                                                                                                                                                                                        |                                                |                                                                                                                                           | Recorder <b>DS</b> |                         |
| ◇Samples <b>6</b> 1 BAG                                                                                                                                                                                                                                                                                                                                             |                                                |                                                                                                                                           | Date <b>20/11</b>  |                         |
| △Building Materials                                                                                                                                                                                                                                                                                                                                                 |                                                |                                                                                                                                           | Initials           |                         |

Oxford Archaeological Unit

|                                                                                                                                                                                                                                                                         |                                                |                                                                                                                                                                          |  |                         |
|-------------------------------------------------------------------------------------------------------------------------------------------------------------------------------------------------------------------------------------------------------------------------|------------------------------------------------|--------------------------------------------------------------------------------------------------------------------------------------------------------------------------|--|-------------------------|
| SITE<br><i>OLROD</i>                                                                                                                                                                                                                                                    |                                                | CONTEXT RECORD                                                                                                                                                           |  | Context No. <i>1100</i> |
| Trench                                                                                                                                                                                                                                                                  |                                                | Additional Sheets:                                                                                                                                                       |  | Type <i>LAYER</i>       |
| Site sub-div <i>SC</i>                                                                                                                                                                                                                                                  | Context Type: <i>Deposit</i> / Cut / Structure | Check Lists:                                                                                                                                                             |  |                         |
| Structure No.                                                                                                                                                                                                                                                           | Overlain by: <i>1099</i>                       | DEPOSIT:                                                                                                                                                                 |  |                         |
| Plan No.                                                                                                                                                                                                                                                                | Abutted by:                                    | 1.compaction 2.colour<br>3.composition<br>4.inclusions 5.thickness<br>6.extend 7.comments<br>8.method & conditions                                                       |  |                         |
| Section No.<br><i>14 / 19</i>                                                                                                                                                                                                                                           | Cut by:                                        | CUT:                                                                                                                                                                     |  |                         |
| Co-Ordinates                                                                                                                                                                                                                                                            | Filled by:                                     | 1.shape in plan<br>2.base/sides/top profile<br>3.dimension and depth<br>4.sketch 5.truncation<br>6.fill nos 7.other comments                                             |  |                         |
| Level                                                                                                                                                                                                                                                                   | Same as:                                       | MASONRY:                                                                                                                                                                 |  |                         |
| Slide No.                                                                                                                                                                                                                                                               | Part of:                                       | 1.materials 2.size of bricks etc 3.finish of stones 4.coursing/bond<br>5.form 6.faces 7.bond<br>8.dimensions as found<br>9.other comments                                |  |                         |
| Neg No.                                                                                                                                                                                                                                                                 | Consists of:                                   |                                                                                                                                                                          |  |                         |
| Matrix location                                                                                                                                                                                                                                                         | Overlies: <i>1104</i>                          |                                                                                                                                                                          |  |                         |
| Description (See check lists):                                                                                                                                                                                                                                          |                                                | STRATIGRAPHIC MATRIX                                                                                                                                                     |  |                         |
| <i>Friable - clay sand, less csm,<br/>gravelly bone/shell.</i>                                                                                                                                                                                                          |                                                | <p>Diagram description: A central box labeled 'this context is' is connected by lines to four boxes above it and four boxes below it, forming a grid-like structure.</p> |  |                         |
|                                                                                                                                                                                                                                                                         |                                                |                                                                                                                                                                          |  |                         |
|                                                                                                                                                                                                                                                                         |                                                |                                                                                                                                                                          |  |                         |
|                                                                                                                                                                                                                                                                         |                                                |                                                                                                                                                                          |  |                         |
|                                                                                                                                                                                                                                                                         |                                                |                                                                                                                                                                          |  |                         |
| Interpretation/Discussion:                                                                                                                                                                                                                                              |                                                |                                                                                                                                                                          |  |                         |
| <i>Pinned dumping / made ground.</i>                                                                                                                                                                                                                                    |                                                |                                                                                                                                                                          |  |                         |
| Finds (tick): None <input type="checkbox"/> Pot <input type="checkbox"/> Bone <input type="checkbox"/> Flint <input type="checkbox"/> Stone <input type="checkbox"/> Burnt stone <input type="checkbox"/> Glass <input type="checkbox"/> Metal <input type="checkbox"/> |                                                |                                                                                                                                                                          |  |                         |
| CBM <input type="checkbox"/> Wood <input type="checkbox"/> Leather <input type="checkbox"/>                                                                                                                                                                             |                                                |                                                                                                                                                                          |  |                         |
| ΔSmall Finds                                                                                                                                                                                                                                                            |                                                | Recorder <i>JS</i>                                                                                                                                                       |  |                         |
| ◇Samples                                                                                                                                                                                                                                                                |                                                | Date <i>20/11</i>                                                                                                                                                        |  |                         |
| △Building Materials                                                                                                                                                                                                                                                     |                                                | Initials                                                                                                                                                                 |  |                         |

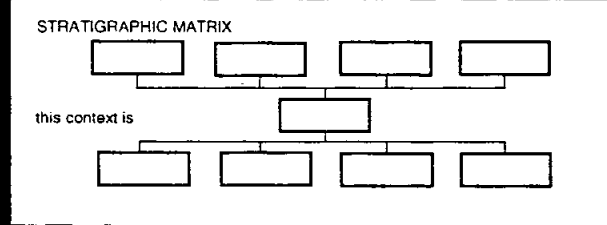
|                                                                                                                                                                                                                                                                                                                                                                        |                                           |                                                                                                                                                             |
|------------------------------------------------------------------------------------------------------------------------------------------------------------------------------------------------------------------------------------------------------------------------------------------------------------------------------------------------------------------------|-------------------------------------------|-------------------------------------------------------------------------------------------------------------------------------------------------------------|
| SITE<br>OLR 00                                                                                                                                                                                                                                                                                                                                                         | CONTEXT RECORD                            | Context No. 1101                                                                                                                                            |
|                                                                                                                                                                                                                                                                                                                                                                        | Additional Sheets:                        | Type LAYER                                                                                                                                                  |
| Trench                                                                                                                                                                                                                                                                                                                                                                 | Context Type: Deposit / Cut / Structure   | Check Lists:                                                                                                                                                |
| Site sub-div SC                                                                                                                                                                                                                                                                                                                                                        | Overlain by: 1106                         | DEPOSIT:<br>1.compaction 2.colour<br>3.composition<br>4.inclusions 5.thickness<br>6.extent 7.comments<br>8.method & conditions                              |
| Structure No.                                                                                                                                                                                                                                                                                                                                                          | Abutted by:                               |                                                                                                                                                             |
| Plan No.                                                                                                                                                                                                                                                                                                                                                               | Cut by:                                   | CUT:<br>1.shape in plan<br>2.base/sides/top profile<br>3.dimension and depth<br>4.sketch 5.truncation<br>6.fill nos 7.other<br>comments                     |
| Section No.<br>14 / 19                                                                                                                                                                                                                                                                                                                                                 | Same as:                                  |                                                                                                                                                             |
| Co-Ordinates                                                                                                                                                                                                                                                                                                                                                           | Part of:                                  | MASONRY:<br>1.materials 2.size of<br>bricks etc 3.finish of<br>stones 4.coursing/bond<br>5.form 6.faces 7.bond<br>8.dimensions as found<br>9.other comments |
| Level                                                                                                                                                                                                                                                                                                                                                                  | Consists of:                              |                                                                                                                                                             |
| Slide No.                                                                                                                                                                                                                                                                                                                                                              | Overlies: 1102 various stone slabs + 1103 |                                                                                                                                                             |
| Neg No.                                                                                                                                                                                                                                                                                                                                                                | Butts:                                    |                                                                                                                                                             |
| Matrix location                                                                                                                                                                                                                                                                                                                                                        | Cuts:                                     |                                                                                                                                                             |
|                                                                                                                                                                                                                                                                                                                                                                        | Fill of:                                  |                                                                                                                                                             |
|                                                                                                                                                                                                                                                                                                                                                                        | Relationships uncertain                   |                                                                                                                                                             |
| Description (See check lists):<br>Tenebris?<br>light-med brown silty clay.<br>c. 0.30 m thickness - spread over<br>SC. area to overlain by a thin<br>deposit.                                                                                                                                                                                                          |                                           | STRATIGRAPHIC MATRIX<br>                                                 |
| Interpretation/Discussion:<br>Dump deposit - overlies recumbent headstones/monument<br>bases - part of landscaping activity - prob 20?                                                                                                                                                                                                                                 |                                           |                                                                                                                                                             |
| Finds (tick): None <input type="checkbox"/> Pot <input type="checkbox"/> Bone <input type="checkbox"/> Flint <input type="checkbox"/> Stone <input type="checkbox"/> Burnt stone <input type="checkbox"/> Glass <input type="checkbox"/> Metal <input type="checkbox"/><br>CBM <input type="checkbox"/> Wood <input type="checkbox"/> Leather <input type="checkbox"/> |                                           |                                                                                                                                                             |
| ΔSmall Finds                                                                                                                                                                                                                                                                                                                                                           |                                           | Recorder DS                                                                                                                                                 |
| ◇Samples                                                                                                                                                                                                                                                                                                                                                               |                                           | Date 20/11                                                                                                                                                  |
| ΔBuilding Materials                                                                                                                                                                                                                                                                                                                                                    |                                           | Initials                                                                                                                                                    |

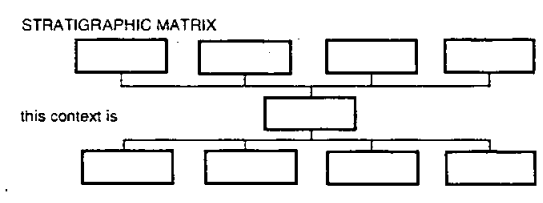
|                                                                                                                                                                                                                                                                                                                                                                        |                                                |                                                                                                                                                             |
|------------------------------------------------------------------------------------------------------------------------------------------------------------------------------------------------------------------------------------------------------------------------------------------------------------------------------------------------------------------------|------------------------------------------------|-------------------------------------------------------------------------------------------------------------------------------------------------------------|
| SITE<br><i>OLR00</i>                                                                                                                                                                                                                                                                                                                                                   | <b>CONTEXT RECORD</b>                          | Context No. <i>1102</i>                                                                                                                                     |
|                                                                                                                                                                                                                                                                                                                                                                        | Additional Sheets:                             | Type <i>LAYER</i>                                                                                                                                           |
| Trench                                                                                                                                                                                                                                                                                                                                                                 | Context Type: <i>Deposit / Cut / Structure</i> | Check Lists:                                                                                                                                                |
| Site sub-div <i>SC</i>                                                                                                                                                                                                                                                                                                                                                 | Overlain by: <i>1101</i>                       | DEPOSIT:<br>1.compaction 2.colour<br>3.composition<br>4.inclusions 5.thickness<br>6.extent 7.comments<br>8.method & conditions                              |
| Structure No.                                                                                                                                                                                                                                                                                                                                                          | Abutted by:                                    |                                                                                                                                                             |
| Plan No.                                                                                                                                                                                                                                                                                                                                                               | Cut by:                                        | CUT:<br>1.shape in plan<br>2.base/sides/top profile<br>3.dimension and depth<br>4.sketch 5.truncation<br>6.fill nos 7.other<br>comments                     |
| Section No.<br><i>14</i>                                                                                                                                                                                                                                                                                                                                               | Filled by:                                     |                                                                                                                                                             |
| Co-Ordinates                                                                                                                                                                                                                                                                                                                                                           | Same as:                                       | MASONRY:<br>1.materials 2.size of<br>bricks etc 3.finish of<br>stones 4.coursing/bond<br>5.form 6.faces 7.bond<br>8.dimensions as found<br>9.other comments |
| Level                                                                                                                                                                                                                                                                                                                                                                  | Part of:                                       |                                                                                                                                                             |
| Slide No.                                                                                                                                                                                                                                                                                                                                                              | Consists of:                                   |                                                                                                                                                             |
| Neg No.                                                                                                                                                                                                                                                                                                                                                                | Overlies: <i>1103</i>                          |                                                                                                                                                             |
| Matrix location                                                                                                                                                                                                                                                                                                                                                        | Butts:                                         |                                                                                                                                                             |
|                                                                                                                                                                                                                                                                                                                                                                        | Cuts:                                          |                                                                                                                                                             |
|                                                                                                                                                                                                                                                                                                                                                                        | Fill of:                                       |                                                                                                                                                             |
|                                                                                                                                                                                                                                                                                                                                                                        | Relationships uncertain                        |                                                                                                                                                             |
| Description (See check lists):<br><i>Friable, dark silty clay - sandy<br/>                 lenses, gravel, some cbm, bone<br/>                 to shell c.1.20m thickness.</i>                                                                                                                                                                                         |                                                | STRATIGRAPHIC MATRIX<br>                                                 |
| Interpretation/Discussion:<br><i>Post med, dump / made gravel.</i>                                                                                                                                                                                                                                                                                                     |                                                |                                                                                                                                                             |
| Finds (tick): None <input type="checkbox"/> Pot <input type="checkbox"/> Bone <input type="checkbox"/> Flint <input type="checkbox"/> Stone <input type="checkbox"/> Burnt stone <input type="checkbox"/> Glass <input type="checkbox"/> Metal <input type="checkbox"/><br>CBM <input type="checkbox"/> Wood <input type="checkbox"/> Leather <input type="checkbox"/> |                                                |                                                                                                                                                             |
| ΔSmall Finds                                                                                                                                                                                                                                                                                                                                                           | Recorder <i>DS</i>                             |                                                                                                                                                             |
| ◇Samples <i>7</i>                                                                                                                                                                                                                                                                                                                                                      | Date <i>20/11</i>                              |                                                                                                                                                             |
| ΔBuilding Materials                                                                                                                                                                                                                                                                                                                                                    | Initials                                       |                                                                                                                                                             |

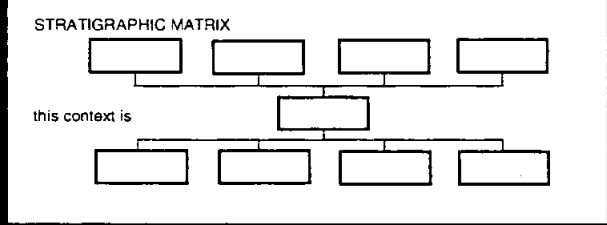

|                                                                                                                                                                                                                                                                                                                                                                        |                                                                                                                                                                                                |                                              |  |                                                                                                                                                             |
|------------------------------------------------------------------------------------------------------------------------------------------------------------------------------------------------------------------------------------------------------------------------------------------------------------------------------------------------------------------------|------------------------------------------------------------------------------------------------------------------------------------------------------------------------------------------------|----------------------------------------------|--|-------------------------------------------------------------------------------------------------------------------------------------------------------------|
| SITE<br><b>OLR00</b>                                                                                                                                                                                                                                                                                                                                                   |                                                                                                                                                                                                | CONTEXT RECORD                               |  | Context No.<br><b>1103</b>                                                                                                                                  |
| Trench                                                                                                                                                                                                                                                                                                                                                                 |                                                                                                                                                                                                | Additional Sheets:                           |  | Type <b>LAYER</b>                                                                                                                                           |
| Site sub-div<br><b>SC</b>                                                                                                                                                                                                                                                                                                                                              | Context Type: <b>Deposit</b> / Cut / Structure                                                                                                                                                 | Overlain by: <b>1102</b> <b>1101</b> & Slabs |  | Check Lists:                                                                                                                                                |
| Structure No.                                                                                                                                                                                                                                                                                                                                                          | Abutted by:                                                                                                                                                                                    | Cut by:                                      |  | DEPOSIT:<br>1.compaction 2.colour<br>3.composition<br>4.inclusions 5.thickness<br>6.extent 7.comments<br>8.method & conditions                              |
| Plan No.                                                                                                                                                                                                                                                                                                                                                               | Filled by:                                                                                                                                                                                     | Same as:                                     |  |                                                                                                                                                             |
| Section No.<br><b>14   19</b>                                                                                                                                                                                                                                                                                                                                          | Part of:                                                                                                                                                                                       | Consists of:                                 |  | CUT:<br>1.shape in plan<br>2.base/sides/top profile<br>3.dimension and depth<br>4.sketch 5.unction<br>6.fill nos 7.other<br>comments                        |
| Co-Ordinates                                                                                                                                                                                                                                                                                                                                                           | Overlies:                                                                                                                                                                                      | Butts:                                       |  |                                                                                                                                                             |
| Level                                                                                                                                                                                                                                                                                                                                                                  | Cuts:                                                                                                                                                                                          | Fill of:                                     |  | MASONRY:<br>1.materials 2.size of<br>bricks etc 3.finish of<br>stones 4.coursing/bond<br>5.form 6.faces 7.bond<br>8.dimensions as found<br>9.other comments |
| Slide No.                                                                                                                                                                                                                                                                                                                                                              | Relationships uncertain                                                                                                                                                                        | Matrix location                              |  |                                                                                                                                                             |
| Neg No.                                                                                                                                                                                                                                                                                                                                                                | Description (See check lists):<br><b>Friable mid brown silty clay.</b><br><b>- base shell pot com.</b><br><b>Generally 1.2 - 1.5m thick - deeper</b><br><b>where it is filling grave cuts.</b> |                                              |  |                                                                                                                                                             |
| Matrix location                                                                                                                                                                                                                                                                                                                                                        | STRATIGRAPHIC MATRIX<br>                                                                                    |                                              |  |                                                                                                                                                             |
| Interpretation/Discussion:<br><b>S.C. Graveyard Soil (includes general deposit -</b><br><b>fab damaged after church construction &amp; subsequent grave fills).</b>                                                                                                                                                                                                    |                                                                                                                                                                                                |                                              |  |                                                                                                                                                             |
| Finds (tick): None <input type="checkbox"/> Pot <input type="checkbox"/> Bone <input type="checkbox"/> Flint <input type="checkbox"/> Stone <input type="checkbox"/> Burnt stone <input type="checkbox"/> Glass <input type="checkbox"/> Metal <input type="checkbox"/><br>CBM <input type="checkbox"/> Wood <input type="checkbox"/> Leather <input type="checkbox"/> |                                                                                                                                                                                                |                                              |  |                                                                                                                                                             |
| ΔSmall Finds                                                                                                                                                                                                                                                                                                                                                           | 8 com?                                                                                                                                                                                         |                                              |  | Recorder <b>DS</b>                                                                                                                                          |
| ◇Samples                                                                                                                                                                                                                                                                                                                                                               | 5                                                                                                                                                                                              |                                              |  | Date <b>20/11</b>                                                                                                                                           |
| △Building Materials                                                                                                                                                                                                                                                                                                                                                    |                                                                                                                                                                                                |                                              |  | Initials                                                                                                                                                    |

| SITE                                                                                                                                                                                                                                                                                                                                                                |                                         | CONTEXT RECORD                                                                                                                         |             | Context No. |
|---------------------------------------------------------------------------------------------------------------------------------------------------------------------------------------------------------------------------------------------------------------------------------------------------------------------------------------------------------------------|-----------------------------------------|----------------------------------------------------------------------------------------------------------------------------------------|-------------|-------------|
| OLR00                                                                                                                                                                                                                                                                                                                                                               |                                         | Additional Sheets:                                                                                                                     |             | 1104        |
| Trench                                                                                                                                                                                                                                                                                                                                                              | Context Type: Deposit / Cut / Structure |                                                                                                                                        |             | Type LAYER  |
| Site sub-div SC                                                                                                                                                                                                                                                                                                                                                     | Overlain by: 1100                       | Check Lists:                                                                                                                           |             |             |
| Structure No.                                                                                                                                                                                                                                                                                                                                                       | Abutted by:                             | DEPOSIT:                                                                                                                               |             |             |
| Plan No.                                                                                                                                                                                                                                                                                                                                                            | Cut by:                                 | 1.compaction 2.colour<br>3.composition<br>4.inclusions 5.thickness<br>6.extent 7.comments<br>8.method & conditions                     |             |             |
| Section No. 19                                                                                                                                                                                                                                                                                                                                                      | Filled by:                              | CUT:                                                                                                                                   |             |             |
|                                                                                                                                                                                                                                                                                                                                                                     | Same as:                                | 1.shape in plan<br>2.base/sides/top profile<br>3.dimension and depth<br>4.sketch 5.truncation<br>6.fill nos 7.other comments           |             |             |
| Co-Ordinates                                                                                                                                                                                                                                                                                                                                                        | Part of:                                | MASONRY:                                                                                                                               |             |             |
| Level                                                                                                                                                                                                                                                                                                                                                               | Consists of:                            | 1.materials 2.size of bricks etc 3.finish of stones 4.coursing/bond<br>5.form 6.faces 7.bond 8.dimensions as found<br>9.other comments |             |             |
| Slide No.                                                                                                                                                                                                                                                                                                                                                           | Overlies: 1105                          |                                                                                                                                        |             |             |
| Neg No.                                                                                                                                                                                                                                                                                                                                                             | Butts:                                  |                                                                                                                                        |             |             |
| Matrix location                                                                                                                                                                                                                                                                                                                                                     | Cuts:                                   |                                                                                                                                        |             |             |
|                                                                                                                                                                                                                                                                                                                                                                     | Fill of:                                |                                                                                                                                        |             |             |
|                                                                                                                                                                                                                                                                                                                                                                     | Relationships uncertain                 |                                                                                                                                        |             |             |
| Description (See check lists):                                                                                                                                                                                                                                                                                                                                      |                                         | STRATIGRAPHIC MATRIX                                                                                                                   |             |             |
| Light brown Brick earth                                                                                                                                                                                                                                                                                                                                             |                                         | <p>this context is</p>                                                                                                                 |             |             |
| C. 0.20m seen - not always present when ground raised i.e.:- leaving truncated.                                                                                                                                                                                                                                                                                     |                                         |                                                                                                                                        |             |             |
| Interpretation/Discussion:                                                                                                                                                                                                                                                                                                                                          |                                         | NATURAL BRICK EARTH.                                                                                                                   |             |             |
| Finds (tick): None <input type="checkbox"/> Pot <input type="checkbox"/> Bone <input type="checkbox"/> Flint <input type="checkbox"/> Stone <input type="checkbox"/> Burnt stone <input type="checkbox"/> Glass <input type="checkbox"/> Metal <input type="checkbox"/> CBM <input type="checkbox"/> Wood <input type="checkbox"/> Leather <input type="checkbox"/> |                                         |                                                                                                                                        |             |             |
| ΔSmall Finds                                                                                                                                                                                                                                                                                                                                                        |                                         |                                                                                                                                        | Recorder DS |             |
| ◇Samples                                                                                                                                                                                                                                                                                                                                                            |                                         |                                                                                                                                        | Date 20/11  |             |
| △Building Materials                                                                                                                                                                                                                                                                                                                                                 |                                         |                                                                                                                                        | Initials    |             |

|                                                                                                                                                                                                                                                                                                                                                                     |                                                |                                                                                                                                                                                                                                                                                                                                                                                                                                                                                                                                                                              |                    |                         |
|---------------------------------------------------------------------------------------------------------------------------------------------------------------------------------------------------------------------------------------------------------------------------------------------------------------------------------------------------------------------|------------------------------------------------|------------------------------------------------------------------------------------------------------------------------------------------------------------------------------------------------------------------------------------------------------------------------------------------------------------------------------------------------------------------------------------------------------------------------------------------------------------------------------------------------------------------------------------------------------------------------------|--------------------|-------------------------|
| SITE<br><b>OLR00</b>                                                                                                                                                                                                                                                                                                                                                |                                                | CONTEXT RECORD                                                                                                                                                                                                                                                                                                                                                                                                                                                                                                                                                               |                    | Context No. <b>1105</b> |
| Trench                                                                                                                                                                                                                                                                                                                                                              |                                                | Additional Sheets:                                                                                                                                                                                                                                                                                                                                                                                                                                                                                                                                                           |                    | Type <b>LAYER</b>       |
| Site sub-div <b>S.C.</b>                                                                                                                                                                                                                                                                                                                                            | Context Type: <b>Deposit</b> / Cut / Structure | Check Lists:                                                                                                                                                                                                                                                                                                                                                                                                                                                                                                                                                                 |                    |                         |
| Structure No.                                                                                                                                                                                                                                                                                                                                                       | Overlain by: <b>1104</b> <b>1100</b>           | DEPOSIT:                                                                                                                                                                                                                                                                                                                                                                                                                                                                                                                                                                     |                    |                         |
| Plan No.                                                                                                                                                                                                                                                                                                                                                            | Abutted by:                                    | 1.compaction 2.colour<br>3.composition<br>4.inclusions 5.thickness<br>6.extent 7.comments<br>8.method & conditions                                                                                                                                                                                                                                                                                                                                                                                                                                                           |                    |                         |
| Section No. <b>19</b>                                                                                                                                                                                                                                                                                                                                               | Cut by:                                        | CUT:                                                                                                                                                                                                                                                                                                                                                                                                                                                                                                                                                                         |                    |                         |
| Co-Ordinates                                                                                                                                                                                                                                                                                                                                                        | Filled by:                                     | 1.shape in plan<br>2.base/sides/top profile<br>3.dimension and depth<br>4.sketch 5.function<br>6.fill nos 7.other comments                                                                                                                                                                                                                                                                                                                                                                                                                                                   |                    |                         |
| Level                                                                                                                                                                                                                                                                                                                                                               | Same as:                                       | MASONSRY:                                                                                                                                                                                                                                                                                                                                                                                                                                                                                                                                                                    |                    |                         |
| Slide No.                                                                                                                                                                                                                                                                                                                                                           | Part of:                                       | 1.materials 2.size of bricks etc 3.finish of stones 4.coursing/bond<br>5.form 6.faces 7.bond<br>8.dimensions as found<br>9.other comments                                                                                                                                                                                                                                                                                                                                                                                                                                    |                    |                         |
| Neg No.                                                                                                                                                                                                                                                                                                                                                             | Consists of:                                   |                                                                                                                                                                                                                                                                                                                                                                                                                                                                                                                                                                              |                    |                         |
| Matrix location                                                                                                                                                                                                                                                                                                                                                     | Overlies:                                      |                                                                                                                                                                                                                                                                                                                                                                                                                                                                                                                                                                              |                    |                         |
|                                                                                                                                                                                                                                                                                                                                                                     | Butts:                                         |                                                                                                                                                                                                                                                                                                                                                                                                                                                                                                                                                                              |                    |                         |
|                                                                                                                                                                                                                                                                                                                                                                     | Cuts:                                          |                                                                                                                                                                                                                                                                                                                                                                                                                                                                                                                                                                              |                    |                         |
|                                                                                                                                                                                                                                                                                                                                                                     | Fill of:                                       |                                                                                                                                                                                                                                                                                                                                                                                                                                                                                                                                                                              |                    |                         |
|                                                                                                                                                                                                                                                                                                                                                                     | Relationships uncertain                        |                                                                                                                                                                                                                                                                                                                                                                                                                                                                                                                                                                              |                    |                         |
| Description (See check lists):                                                                                                                                                                                                                                                                                                                                      |                                                | STRATIGRAPHIC MATRIX                                                                                                                                                                                                                                                                                                                                                                                                                                                                                                                                                         |                    |                         |
| <b>Natural gravel.</b>                                                                                                                                                                                                                                                                                                                                              |                                                | <pre> graph TD     A[ ] --- B[ ]     A --- C[ ]     A --- D[ ]     A --- E[ ]     B --- F[ ]     C --- F[ ]     D --- F[ ]     E --- F[ ]     F --- G[ ]     F --- H[ ]     F --- I[ ]     F --- J[ ]     style A fill:#fff,stroke:#000     style B fill:#fff,stroke:#000     style C fill:#fff,stroke:#000     style D fill:#fff,stroke:#000     style E fill:#fff,stroke:#000     style F fill:#fff,stroke:#000     style G fill:#fff,stroke:#000     style H fill:#fff,stroke:#000     style I fill:#fff,stroke:#000     style J fill:#fff,stroke:#000             </pre> |                    |                         |
| Seen intermittently in bottom of some excavation pits at about formation level (17.125m OD) - sometimes overlain by brickearth but brickearth fairly heavily truncated.                                                                                                                                                                                             |                                                |                                                                                                                                                                                                                                                                                                                                                                                                                                                                                                                                                                              |                    |                         |
| Interpretation/Discussion:                                                                                                                                                                                                                                                                                                                                          |                                                |                                                                                                                                                                                                                                                                                                                                                                                                                                                                                                                                                                              |                    |                         |
| <b>NATURAL GRAVEL.</b>                                                                                                                                                                                                                                                                                                                                              |                                                |                                                                                                                                                                                                                                                                                                                                                                                                                                                                                                                                                                              |                    |                         |
| Finds (tick): None <input type="checkbox"/> Pot <input type="checkbox"/> Bone <input type="checkbox"/> Flint <input type="checkbox"/> Stone <input type="checkbox"/> Burnt stone <input type="checkbox"/> Glass <input type="checkbox"/> Metal <input type="checkbox"/> CBM <input type="checkbox"/> Wood <input type="checkbox"/> Leather <input type="checkbox"/> |                                                |                                                                                                                                                                                                                                                                                                                                                                                                                                                                                                                                                                              |                    |                         |
| ΔSmall Finds                                                                                                                                                                                                                                                                                                                                                        |                                                |                                                                                                                                                                                                                                                                                                                                                                                                                                                                                                                                                                              | Recorder <b>DS</b> |                         |
| ◇Samples                                                                                                                                                                                                                                                                                                                                                            |                                                |                                                                                                                                                                                                                                                                                                                                                                                                                                                                                                                                                                              | Date <b>20/11</b>  |                         |
| △Building Materials                                                                                                                                                                                                                                                                                                                                                 |                                                |                                                                                                                                                                                                                                                                                                                                                                                                                                                                                                                                                                              | Initials           |                         |

|                                                                                                                                                                                                                                                                                                                                                                        |                                         |                                                                                                                                              |             |                  |
|------------------------------------------------------------------------------------------------------------------------------------------------------------------------------------------------------------------------------------------------------------------------------------------------------------------------------------------------------------------------|-----------------------------------------|----------------------------------------------------------------------------------------------------------------------------------------------|-------------|------------------|
| <b>SITE</b><br>OL200                                                                                                                                                                                                                                                                                                                                                   |                                         | <b>CONTEXT RECORD</b>                                                                                                                        |             | Context No. 1106 |
| Trench                                                                                                                                                                                                                                                                                                                                                                 |                                         | Additional Sheets:                                                                                                                           |             | Type LAYER       |
| Site sub-div SC                                                                                                                                                                                                                                                                                                                                                        | Context Type: Deposit / Cut / Structure | Check Lists:                                                                                                                                 |             |                  |
| Structure No.                                                                                                                                                                                                                                                                                                                                                          | Overlain by:                            | DEPOSIT:                                                                                                                                     |             |                  |
| Plan No.                                                                                                                                                                                                                                                                                                                                                               | Abutted by:                             | 1.compaction 2.colour<br>3.composition<br>4.inclusions 5.thickness<br>6.extent 7.comments<br>8.method & conditions                           |             |                  |
| Section No. 19                                                                                                                                                                                                                                                                                                                                                         | Cut by:                                 | CUT:                                                                                                                                         |             |                  |
| Co-Ordinates                                                                                                                                                                                                                                                                                                                                                           | Filled by:                              | 1.shape in plan<br>2.base/sides/top profile<br>3.dimension and depth<br>4.sketch 5.truncation<br>6.fill nos 7/other comments                 |             |                  |
| Level                                                                                                                                                                                                                                                                                                                                                                  | Same as:                                | MASONRY:                                                                                                                                     |             |                  |
| Slide No.                                                                                                                                                                                                                                                                                                                                                              | Part of:                                | 1.materials 2.size of bricks etc<br>3.finish of stones 4.coursing/bond<br>5.form 6.faces 7.bond<br>8.dimensions as found<br>9.other comments |             |                  |
| Neg No.                                                                                                                                                                                                                                                                                                                                                                | Consists of:                            | Overlies: 1101                                                                                                                               |             |                  |
| Matrix location                                                                                                                                                                                                                                                                                                                                                        | Butts:                                  | Relationships uncertain                                                                                                                      |             |                  |
| Description (See check lists):                                                                                                                                                                                                                                                                                                                                         |                                         | STRATIGRAPHIC MATRIX                                                                                                                         |             |                  |
| Friable dark brown silty clay, small flints.                                                                                                                                                                                                                                                                                                                           |                                         |                                                                                                                                              |             |                  |
| Interpretation/Discussion:                                                                                                                                                                                                                                                                                                                                             |                                         |                                                                                                                                              |             |                  |
| modern topsoil - part of @? landscaping.                                                                                                                                                                                                                                                                                                                               |                                         |                                                                                                                                              |             |                  |
| Finds (tick): None <input type="checkbox"/> Pot <input type="checkbox"/> Bone <input type="checkbox"/> Flint <input type="checkbox"/> Stone <input type="checkbox"/> Burnt stone <input type="checkbox"/> Glass <input type="checkbox"/> Metal <input type="checkbox"/><br>CBM <input type="checkbox"/> Wood <input type="checkbox"/> Leather <input type="checkbox"/> |                                         |                                                                                                                                              |             |                  |
| ΔSmall Finds                                                                                                                                                                                                                                                                                                                                                           |                                         |                                                                                                                                              | Recorder DS |                  |
| ◇Samples                                                                                                                                                                                                                                                                                                                                                               |                                         |                                                                                                                                              | Date 20/11  |                  |
| ΔBuilding Materials                                                                                                                                                                                                                                                                                                                                                    |                                         |                                                                                                                                              | Initials    |                  |

| SITE <i>OK200</i>                                      |                                                          | COFFIN RECORD SHEET             | CONTEXT NO. <i>1107</i> |
|--------------------------------------------------------|----------------------------------------------------------|---------------------------------|-------------------------|
| Trench:                                                | Additional sheets:                                       | Treatment: <i>BONES LIFTED.</i> |                         |
| Site sub-div: <i>N.C.</i>                              | Grave fills:                                             |                                 |                         |
| Plan no: <i>3</i>                                      | Grave cut:                                               | Finds                           |                         |
| Section no:                                            | Skeleton:                                                | None                            |                         |
| Co-ordinates:                                          | Matrix location: <i>in w/ 330.<br/>truncated by 329.</i> | Breastplate                     |                         |
| Levels:                                                | Preservation: <i>GOOD.</i>                               | Grip                            |                         |
| Slide No.:                                             | Neg No:                                                  | Hinge                           |                         |
| Description                                            |                                                          | Bracket                         |                         |
| <i>identified during osteological analysis, E → W.</i> |                                                          | Fixing nails                    |                         |
|                                                        |                                                          | Shroud pins                     |                         |
| Discussion                                             |                                                          | Fabric                          |                         |
| Shape, dimensions and distinguishing characteristics   |                                                          | Other finds                     |                         |
| LID                                                    |                                                          |                                 |                         |
| HEAD                                                   |                                                          |                                 |                         |
| BASE                                                   |                                                          |                                 |                         |
| Recorder: <i>Julie R.</i>                              | Date: <i>29/11/00</i>                                    | Initials:                       |                         |

| SITE                                                                                           | COFFIN RECORD SHEET   |                             | CONTEXT NO. |
|------------------------------------------------------------------------------------------------|-----------------------|-----------------------------|-------------|
| 04200                                                                                          | Additional sheets:    | 1108                        |             |
| Trench:                                                                                        | Grave fills           | Treatment:<br>BONES W/ATED  |             |
| Site sub-div:<br>SC                                                                            | Grave cut:            | Finds<br>None ✓             |             |
| Plan no:<br>6.                                                                                 | Skeleton:             | Breastplate<br>Grip         |             |
| Section no:                                                                                    | Matrix location:      | Hinge<br>Bracket            |             |
| Co-ordinates:                                                                                  | 1108 o/L 1110         | Fixing nails<br>Shroud pins |             |
| Levels                                                                                         | Preservation:<br>POOR | Fabric<br>Other finds       |             |
| Slide No.                                                                                      | Neg No:               |                             |             |
| <p>Description ADULT EW BURIAL.<br/>COMPLETE LEFT LEG MISSING.</p> <p>Discussion</p>           |                       |                             |             |
| <p>Shape, dimensions and distinguishing characteristics</p> <p>LID</p> <p>HEAD</p> <p>BASE</p> |                       |                             |             |
| Recorder:                                                                                      | Date:                 | Initials:                   |             |
| DM                                                                                             | 30.11.00.             |                             |             |

| SITE                                                                                      |  | COFFIN RECORD SHEET |  | CONTEXT NO.   |  |
|-------------------------------------------------------------------------------------------|--|---------------------|--|---------------|--|
| 02200                                                                                     |  |                     |  | 1109          |  |
| Trench:                                                                                   |  | Additional sheets:  |  | Treatment:    |  |
| Site sub-div: SC                                                                          |  | Grave fills         |  | BONES LIFTED. |  |
| Plan no: 6.                                                                               |  | Grave cut:          |  | Finds         |  |
| Section no:                                                                               |  | Skeleton:           |  | None          |  |
| Co-ordinates:                                                                             |  | Matrix location:    |  | Breastplate   |  |
| Levels                                                                                    |  | Preservation: Good. |  | Grip          |  |
| Slide No.                                                                                 |  | Neg No:             |  | Hinge         |  |
|                                                                                           |  |                     |  | Bracket       |  |
|                                                                                           |  |                     |  | Fixing nails  |  |
|                                                                                           |  |                     |  | Shroud pins   |  |
|                                                                                           |  |                     |  | Fabric        |  |
|                                                                                           |  |                     |  | Other finds   |  |
| Description EAST-WEST ADULT BURIAL.<br>BURIAL MACHINED OUT AS TOO NEAR DANGEROUS SECTION. |  |                     |  |               |  |
| Discussion                                                                                |  |                     |  |               |  |
| Shape, dimensions and distinguishing characteristics                                      |  |                     |  |               |  |
| LID                                                                                       |  |                     |  |               |  |
| HEAD                                                                                      |  |                     |  |               |  |
| BASE                                                                                      |  |                     |  |               |  |
| Recorder: [Signature]                                                                     |  | Date: 30.11.00.     |  | Initials:     |  |

| SITE                                                 |  | COFFIN RECORD SHEET                                             |  | CONTEXT NO.  |  |
|------------------------------------------------------|--|-----------------------------------------------------------------|--|--------------|--|
| 04200                                                |  |                                                                 |  | 1110         |  |
| Trench:                                              |  | Additional sheets:                                              |  | Treatment:   |  |
| Site sub-div: S.C.                                   |  | Grave fills                                                     |  | BONES LIFTED |  |
| Plan no: 6                                           |  | Grave cut:                                                      |  | Finds        |  |
| Section no:                                          |  | Skeleton:                                                       |  | None         |  |
| Co-ordinates:                                        |  | Matrix location: V/L (1108)                                     |  | Breastplate  |  |
| Levels                                               |  | Preservation:                                                   |  | Grip         |  |
| Slide No.                                            |  | Neg No:                                                         |  | Hinge        |  |
| Description                                          |  | E-W ABOUT BURIAL. MAINTAINED CUT AS TOO NEAR DANGEROUS SECTION. |  | Bracket      |  |
| Discussion                                           |  |                                                                 |  | Fixing nails |  |
| Shape, dimensions and distinguishing characteristics |  |                                                                 |  | Shroud pins  |  |
| LID                                                  |  |                                                                 |  | Fabric       |  |
| HEAD                                                 |  |                                                                 |  | Other finds  |  |
| BASE                                                 |  |                                                                 |  |              |  |
| Recorder: DM                                         |  | Date: 30/11/00                                                  |  | Initials:    |  |



Site Code

Context

**Outer Coffin**

Sample Ret.

OH100

1110

Recording Date ..... 22/2/01 .....

Associated Numbers .....

Condition .....

Dep. Plate

Legible

Inscription

Fabric lead  ormolou  brass  tin plated pewter  gilt tin   
 iron  silvered tin  enamelled  other ..... Sample Ret.

**Shape of dep. plate**

square  rectangle  shield  tapered  lozenge   
 cartouche  oval  other .....

**Upholstery**

colour ..... shoddy  velvet  other ..... Sample Ret.

**Construction**

butt joint  mitred  pitched  other .....

**Grip plate**

Fabric = ormolou  brass  tin plated pewter  gilt tin   
 iron  *knags on rev of grip-wood.* silvered tin  enamelled  other ..... Sample Ret.

**Grip**

Fabric = ormolou  brass  iron  *x3* Sample Ret.

**Design**

swag of rose  horseshoe  cherub's head  *5'S* plain

other .....

**Grip bolts**

**Corner bolts**  Type = gilt brass  brass  iron

other ..... Sample Ret.

**Lid motifs**

other ..... Sample Ret.

**Escutcheons**

other ..... Sample Ret.

**Upholstery nails**

brass  gilt brass  silvered brass  iron  enamelled

other ..... Sample Ret.

**Fixings**

panel nails  screws  hinges  lace  Sample Ret.

**Timber type**

..... Sample Ret.

**Interpretation / Comments**

.....  
 .....

| SITE <u>AR 00</u>                                                                                                                            |                                           | COFFIN RECORD SHEET | CONTEXT NO. <u>111</u> |
|----------------------------------------------------------------------------------------------------------------------------------------------|-------------------------------------------|---------------------|------------------------|
| Trench:                                                                                                                                      | Additional sheets:                        | Treatment:          |                        |
| Site sub-div: <u>SR.</u>                                                                                                                     | Grave fills:                              | <u>BONES LIFTED</u> |                        |
| Plan no: <u>6</u>                                                                                                                            | Grave cut:                                | Finds               |                        |
| Section no:                                                                                                                                  | Skeleton:                                 | None                |                        |
| Co-ordinates:                                                                                                                                | Matrix location: <u>U/L</u> <u>(1109)</u> | Breastplate         |                        |
| Levels:                                                                                                                                      | Preservation:                             | Grip                |                        |
| Slide No.:                                                                                                                                   | Neg No.:                                  | Hinge               |                        |
| Description                                                                                                                                  |                                           | Bracket             |                        |
| <p><u>E-W ADULT BURIAL. MACHINED OUT AS TOO NEAR DANGEROUS SECTION. VERY NEAR TO (1112) - MACHINED OUT TOGETHER AND BAGGED TOGETHER.</u></p> |                                           | Fixing nails        |                        |
| Discussion                                                                                                                                   |                                           | Shroud pins         |                        |
| <p><u>MIXING POSSIBLE WITH UNDERLYING (1113).</u></p>                                                                                        |                                           | Fabric              |                        |
| Shape, dimensions and distinguishing characteristics                                                                                         |                                           |                     |                        |
| LID                                                                                                                                          |                                           |                     |                        |
| HEAD                                                                                                                                         |                                           |                     |                        |
| BASE                                                                                                                                         |                                           |                     |                        |
| Recorder: <u>DM</u>                                                                                                                          | Date: <u>30/11/00</u>                     | Initials:           |                        |

| SITE                                                                                                                                                                                                                                                                        |  | COFFIN RECORD SHEET |  | CONTEXT NO.  |  |
|-----------------------------------------------------------------------------------------------------------------------------------------------------------------------------------------------------------------------------------------------------------------------------|--|---------------------|--|--------------|--|
| OLR 00                                                                                                                                                                                                                                                                      |  |                     |  | 1112         |  |
| Trench:                                                                                                                                                                                                                                                                     |  | Additional sheets:  |  | Treatment:   |  |
| Site sub-div: S.C.                                                                                                                                                                                                                                                          |  | Grave fills         |  | BONES LIFTED |  |
| Plan no: 6                                                                                                                                                                                                                                                                  |  | Grave cut:          |  | Finds        |  |
| Section no:                                                                                                                                                                                                                                                                 |  | Skeleton:           |  | None         |  |
| Co-ordinates:                                                                                                                                                                                                                                                               |  | Matrix location:    |  | Breastplate  |  |
|                                                                                                                                                                                                                                                                             |  | (1112) u/l (1111)   |  | Grip         |  |
| Levels                                                                                                                                                                                                                                                                      |  | Preservation:       |  | Hinge        |  |
| Slide No.                                                                                                                                                                                                                                                                   |  | Neg No:             |  | Bracket      |  |
|                                                                                                                                                                                                                                                                             |  |                     |  | Fixing nails |  |
|                                                                                                                                                                                                                                                                             |  |                     |  | Shroud pins  |  |
|                                                                                                                                                                                                                                                                             |  |                     |  | Fabric       |  |
|                                                                                                                                                                                                                                                                             |  |                     |  | Other finds  |  |
| <p>Description E-W ADULT BURIAL WOODEN COFFIN,<br/> Fe - SANDWICH, MACHINED OUT AS TOO NEAR<br/> DANGEROUS SECTION. VERY NEAR TO (1111) AND MACHINED<br/> OUT TOGETHER WITH (1111) AND BAGGED TOGETHER.<br/> Discussion POSSIBLE MIXING WITH (1113) WHICH UNDERLIES IT.</p> |  |                     |  |              |  |
| Shape, dimensions and distinguishing characteristics                                                                                                                                                                                                                        |  |                     |  |              |  |
| LID                                                                                                                                                                                                                                                                         |  |                     |  |              |  |
| HEAD                                                                                                                                                                                                                                                                        |  |                     |  |              |  |
| BASE                                                                                                                                                                                                                                                                        |  |                     |  |              |  |
| Recorder: OM                                                                                                                                                                                                                                                                |  | Date: 30/11/00      |  | Initials:    |  |

Site Code

Context

**Outer Coffin**

Sample Ret.

OK200

1112

Recording Date ..... 22/2/01 .....

Associated Numbers .....

Condition .....

Dep. Plate

Legible

**Inscription**

Fabric lead  ormolou  brass  tin plated pewter  gilt tin   
 iron  silvered tin  enamelled  other ..... Sample Ret.

**Shape of dep. plate**

square  rectangle  shield  tapered  lozenge   
 cartouche  oval  other .....

**Upholstery**

colour ..... shoddy  velvet  other ..... Sample Ret.

**Construction**

butt joint  mitred  pitched  other .....

Grip plate  Fabric = ormolou  brass  tin plated pewter  gilt tin   
 iron  silvered tin  enamelled  other ..... Sample Ret.

Grip  Fabric = ormolou  brass  iron  <sup>1 x</sup> Sample Ret.

Design swag of rose  horseshoe  cherub's head  <sup>①</sup> plain   
 other .....

Grip bolts  Corner bolts  Type = gilt brass  brass  iron

other ..... Sample Ret.

Lid motifs  other ..... Sample Ret.

Escutcheons  other ..... Sample Ret.

Upholstery <sup>studs</sup> ~~nails~~  brass  gilt brass  silvered brass  iron  enamelled

other ..... *mentioned on sheet - no samples retained* ..... Sample Ret.

Fixings  panel nails  screws  hinges  lace  Sample Ret.

Timber type ..... Sample Ret.

**Interpretation / Comments**

.....  
 .....

| SITE                                                 |  | COFFIN RECORD SHEET        |  | CONTEXT NO.  |  |
|------------------------------------------------------|--|----------------------------|--|--------------|--|
| OUR 00                                               |  |                            |  | 1113         |  |
| Trench:                                              |  | Additional sheets: 4/65 X1 |  | Treatment:   |  |
| Site sub-div: S.C.                                   |  | Grave fills                |  | BONES LIFTED |  |
| Plan no: 6                                           |  | Grave cut:                 |  | Finds        |  |
| Section no:                                          |  | Skeleton:                  |  | None         |  |
| Co-ordinates:                                        |  | Matrix location:           |  | Breastplate  |  |
| Levels                                               |  | Preservation:              |  | Grip         |  |
| Slide No.                                            |  | Neg No:                    |  | Hinge        |  |
| Description                                          |  | 1113 v/L 1112:             |  | Bracket      |  |
| Discussion                                           |  |                            |  | Fixing nails |  |
| Shape, dimensions and distinguishing characteristics |  |                            |  | Shroud pins  |  |
| LID                                                  |  |                            |  | Fabric       |  |
| HEAD                                                 |  |                            |  | Other finds  |  |
| BASE                                                 |  |                            |  |              |  |
| Recorder: DM                                         |  | Date: 30/1/00              |  | Initials:    |  |

Partly ENE-WSW BURIAL ADULT.  
 MACHINED OUT AS TOO NEAR DANGEROUS SECTION.  
 POSSIBLE MIX UP WITH (1112) AND (1111) WHICH OVERLIED IT.

# Coffin Recording Sheet

Site Code

Context

**Outer Coffin**

Sample Ret.

OK 200

1113

Recording Date ..... 13/2/01. .....

Associated Numbers .....

Condition .....

Dep. Plate

Legible

Inscription

**Fabric** lead  ormolou  brass  tin plated pewter  gilt tin   
 iron  silvered tin  enamelled  other ..... Sample Ret.

**Shape of dep. plate**

square  rectangle  shield  tapered  lozenge   
 cartouche  oval  other .....

**Upholstery**

colour ..... shoddy  velvet  other ..... Sample Ret.

**Construction**

butt joint  mitred  pitched  other .....

**Grip plate**

*Fabric = ormolou*  brass  tin plated pewter  gilt tin   
*Frags on ecu of grip - unid*  
 iron  silvered tin  enamelled  other ..... Sample Ret.

**Grip**

*Fabric = ormolou*  brass  iron  <sup>(A)</sup> Sample Ret.

**Design**

swag of rose  horseshoe  cherub's head  plain

other .....

**Grip bolts**

**Corner bolts**  Type = gilt brass  brass  iron

other ..... Sample Ret.

**Lid motifs**

other ..... Sample Ret.

**Escutcheons**

other ..... Sample Ret.

**Upholstery**

*sheds*  brass  gilt brass  silvered brass  iron  enamelled   
*x 2 singles.*  
 other .....

**Fixings**

panel nails  screws  hinges  lace  Sample Ret.

**Timber type**

..... Sample Ret.

**Interpretation / Comments**

.....  
 .....

| SITE             | COFFIN RECORD SHEET | CONTEXT NO.   |
|------------------|---------------------|---------------|
| 02100            |                     | 1114          |
| Trench:          | Additional sheets:  | Treatment:    |
| Site sub-div: SC | Grave fills         | bones lifted  |
| Plan no: 6       | Grave cut:          | Finds         |
| Section no:      | Skeleton:           | None          |
| Co-ordinates:    | Matrix location:    | Breastplate ✓ |
| Levels           | Preservation:       | Grip          |
| Slide No.        | Neg No:             | Hinge         |
|                  |                     | Bracket       |
|                  |                     | Fixing nails  |
|                  |                     | Shroud pins   |
|                  |                     | Fabric        |
|                  |                     | Other finds   |

Description E-W BURIAL ADULT.

Discussion Pb-OUTTER BREASTPLATE PRESENT BUT NOT READABLE IN FIELD. BURIAL RECORDED AS NAMED - HIGH CHANCES OF BREASTPLATE BEING READABLE AFTER CLEAN UP.

Shape, dimensions and distinguishing characteristics

LID

HEAD

BASE

|                       |                |           |
|-----------------------|----------------|-----------|
| Recorder: [Signature] | Date: 30.11.00 | Initials: |
|-----------------------|----------------|-----------|

| SITE               | COFFIN RECORD SHEET | CONTEXT NO.  |
|--------------------|---------------------|--------------|
| OUR 00             |                     | 145          |
| Trench:            | Additional sheets:  | Treatment:   |
| Site sub-div: S.C. | Grave fills         | BONES LIFTED |
| Plan no: 6         | Grave cut:          | Finds        |
| Section no:        | Skeleton:           | None         |
| Co-ordinates:      | Matrix location:    | Breastplate  |
| Levels             | Preservation: Poor  | Grip         |
| Slide No.          | Neg No:             | Hinge        |
|                    |                     | Bracket      |
|                    |                     | Fixing nails |
|                    |                     | Shroud pins  |
|                    |                     | Fabric       |
|                    |                     | Other finds  |

Description  
 E-W ABOUT BURIAL. WOODEN COFFIN.  
 TRUNCATED FROM KNEES DOWN.  
 LOWER LEGS MISSING.

Discussion

Shape, dimensions and distinguishing characteristics

LID

HEAD

BASE

|              |                |           |
|--------------|----------------|-----------|
| Recorder: DM | Date: 01/12/00 | Initials: |
|--------------|----------------|-----------|



|                                                                                                                                                                                                                                                                                                                                                                                |  |                                                                                                                                                                                                                                                                                                           |  |                                                                                                                                                       |
|--------------------------------------------------------------------------------------------------------------------------------------------------------------------------------------------------------------------------------------------------------------------------------------------------------------------------------------------------------------------------------|--|-----------------------------------------------------------------------------------------------------------------------------------------------------------------------------------------------------------------------------------------------------------------------------------------------------------|--|-------------------------------------------------------------------------------------------------------------------------------------------------------|
| SITE<br>OLR 00                                                                                                                                                                                                                                                                                                                                                                 |  | CONTEXT RECORD                                                                                                                                                                                                                                                                                            |  | Context No. 1116                                                                                                                                      |
| Trench                                                                                                                                                                                                                                                                                                                                                                         |  | Additional Sheets: —                                                                                                                                                                                                                                                                                      |  | Type STREET                                                                                                                                           |
| Site sub-div SE                                                                                                                                                                                                                                                                                                                                                                |  | Context Type: Deposit / Cut / Structure                                                                                                                                                                                                                                                                   |  | Check Lists:                                                                                                                                          |
| Structure No.                                                                                                                                                                                                                                                                                                                                                                  |  | Overlain by: 1115                                                                                                                                                                                                                                                                                         |  | DEPOSIT:<br>1.compaction 2.colour<br>3.composition<br>4.inclusions 5.thickness<br>6.extent 7.comments<br>8.method & conditions                        |
| Plan No. 6                                                                                                                                                                                                                                                                                                                                                                     |  | Abutted by:                                                                                                                                                                                                                                                                                               |  |                                                                                                                                                       |
| Section No.                                                                                                                                                                                                                                                                                                                                                                    |  | Cut by:                                                                                                                                                                                                                                                                                                   |  | CUT:<br>1.shape in plan<br>2.base/sides/top profile<br>3.dimension and depth<br>4.sketch 5.truncation<br>6.fill nos 7.other comments                  |
| Co-Ordinates                                                                                                                                                                                                                                                                                                                                                                   |  | Filled by:                                                                                                                                                                                                                                                                                                |  |                                                                                                                                                       |
| Level                                                                                                                                                                                                                                                                                                                                                                          |  | Same as:                                                                                                                                                                                                                                                                                                  |  | MASONRY:<br>1.materials 2.size of bricks etc 3.finish of stones 4.coursing/bond<br>5.form 6.faces 7.bond<br>8.dimensions as found<br>9.other comments |
| Slide No.                                                                                                                                                                                                                                                                                                                                                                      |  | Part of:                                                                                                                                                                                                                                                                                                  |  |                                                                                                                                                       |
| Neg No.                                                                                                                                                                                                                                                                                                                                                                        |  | Consists of:                                                                                                                                                                                                                                                                                              |  |                                                                                                                                                       |
| Matrix location                                                                                                                                                                                                                                                                                                                                                                |  | Overlies:                                                                                                                                                                                                                                                                                                 |  |                                                                                                                                                       |
|                                                                                                                                                                                                                                                                                                                                                                                |  | Butts:                                                                                                                                                                                                                                                                                                    |  |                                                                                                                                                       |
|                                                                                                                                                                                                                                                                                                                                                                                |  | Cuts:                                                                                                                                                                                                                                                                                                     |  |                                                                                                                                                       |
|                                                                                                                                                                                                                                                                                                                                                                                |  | Fill of:                                                                                                                                                                                                                                                                                                  |  |                                                                                                                                                       |
|                                                                                                                                                                                                                                                                                                                                                                                |  | Relationships uncertain                                                                                                                                                                                                                                                                                   |  |                                                                                                                                                       |
| Description (See check lists):                                                                                                                                                                                                                                                                                                                                                 |  | STRATIGRAPHIC MATRIX                                                                                                                                                                                                                                                                                      |  |                                                                                                                                                       |
| COBBLES SURFACE.                                                                                                                                                                                                                                                                                                                                                               |  | <p>Diagram description: A stratigraphic matrix with four boxes in a top row and four in a bottom row. A vertical line connects the second box from the left in the top row to the second box in the bottom row. Below the top row, the text 'this context is' is followed by a box containing '1116'.</p> |  |                                                                                                                                                       |
| BURIAL 1115 LAYED STRAIGHT ON TOP OF THE SURFACE, GRAVE CUT HAS NOT CUT THE SURFACE 1116, BUT USING IT AS A BASE.                                                                                                                                                                                                                                                              |  |                                                                                                                                                                                                                                                                                                           |  |                                                                                                                                                       |
| Interpretation/Discussion: PRE-CHURCH COBBLES SURFACE MADE UP OF IRREGULARLY LAYED COBBLES AND BRICKS. SITUATED IN SOUTH CHURCHYARD RIGHT NEXT TO SOUTHERN CHURCH WALL. CUT BY CHURCH FOUNDATION TRENCH. USE OF STONE COBBLES AND BRICK RESTRICTED TO SPECIFIC AREAS POSSIBLY ORNAMENTAL BUT MORE LIKELY PATCHING UP OF THE SURFACE.                                           |  |                                                                                                                                                                                                                                                                                                           |  |                                                                                                                                                       |
| Finds (tick): None <input checked="" type="checkbox"/> Pot <input type="checkbox"/> Bone <input type="checkbox"/> Flint <input type="checkbox"/> Stone <input type="checkbox"/> Burnt stone <input type="checkbox"/> Glass <input type="checkbox"/> Metal <input type="checkbox"/> CBM <input type="checkbox"/> Wood <input type="checkbox"/> Leather <input type="checkbox"/> |  |                                                                                                                                                                                                                                                                                                           |  |                                                                                                                                                       |
| Small Finds                                                                                                                                                                                                                                                                                                                                                                    |  | Recorder DM                                                                                                                                                                                                                                                                                               |  |                                                                                                                                                       |
| Samples                                                                                                                                                                                                                                                                                                                                                                        |  | Date 1/12/00                                                                                                                                                                                                                                                                                              |  |                                                                                                                                                       |
| Building Materials                                                                                                                                                                                                                                                                                                                                                             |  | Initials                                                                                                                                                                                                                                                                                                  |  |                                                                                                                                                       |

P.T.O

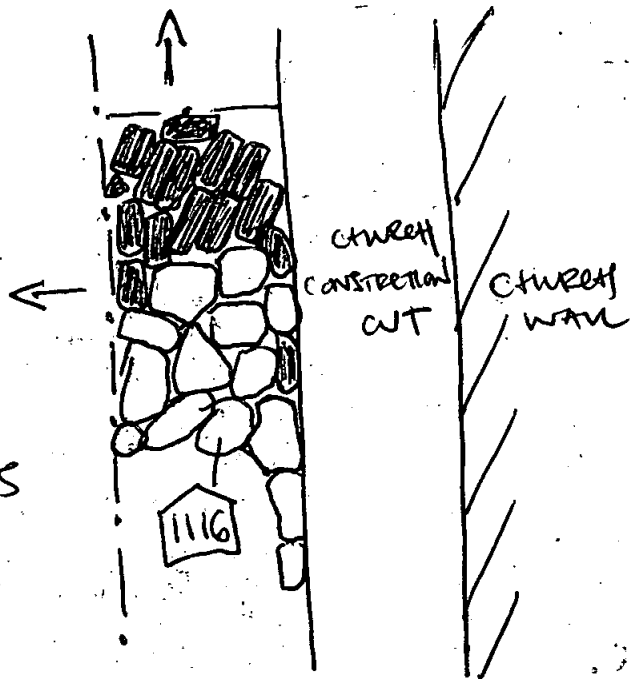

○ STONE COBBLES  
 ■ BRICK

211

CHURCH  
CONSTRUCTION  
CUT

CHURCH  
WALL

...  
 ...  
 ...

...  
 ...  
 ...

M  
 13/1

0.79

|                                                      |  |                                         |  |                         |  |
|------------------------------------------------------|--|-----------------------------------------|--|-------------------------|--|
| SITE <b>OLE 00.</b>                                  |  | COFFIN RECORD SHEET                     |  | CONTEXT NO. <b>1117</b> |  |
| Trench:                                              |  | Additional sheets:                      |  | Treatment:              |  |
| Site sub-div: <b>S.E.</b>                            |  | Grave fills                             |  | <b>BOXES LIFTED</b>     |  |
| Plan no:<br><b>6</b>                                 |  | Grave cut:                              |  | Finds                   |  |
| Section no:                                          |  | Skeleton:                               |  | None                    |  |
| Co-ordinates:                                        |  | Matrix location:                        |  | Breastplate             |  |
| Levels                                               |  | Preservation:<br><b>GOOD</b>            |  | Grip                    |  |
| Slide No.                                            |  | Neg No:                                 |  | Hinge                   |  |
| Description                                          |  | <b>E-W ADULT BURIAL. WOODEN COFFIN.</b> |  |                         |  |
| Discussion                                           |  |                                         |  |                         |  |
| Shape, dimensions and distinguishing characteristics |  |                                         |  |                         |  |
| LID                                                  |  |                                         |  |                         |  |
| HEAD                                                 |  |                                         |  |                         |  |
| BASE                                                 |  |                                         |  |                         |  |
| Recorder: <b>DM</b>                                  |  | Date: <b>04/12/00</b>                   |  | Initials:               |  |

| SITE <b>OLR 00</b>                                   |                                    | COFFIN RECORD SHEET                      | CONTEXT NO. <b>118</b> |
|------------------------------------------------------|------------------------------------|------------------------------------------|------------------------|
| Trench:                                              | Additional sheets: <b>463 x 1.</b> | Treatment:                               |                        |
| Site sub-div: <b>S.R.</b>                            | Grave fills                        | <b>BONES LIFTED</b>                      |                        |
| Plan no: <b>6</b>                                    | Grave cut:                         | Finds                                    |                        |
| Section no:                                          | Skeleton:                          | None                                     |                        |
| Co-ordinates:                                        | Matrix location:                   | Breastplate                              |                        |
| Levels                                               | Preservation: <b>Good</b>          | Grip <input checked="" type="checkbox"/> |                        |
| Slide No.                                            | Neg No:                            | Hinge                                    |                        |
| Description <b>E-W ADULT BURIAL. WOODEN COFFIN.</b>  |                                    | Bracket                                  |                        |
| Discussion                                           |                                    | Fixing nails                             |                        |
| Shape, dimensions and distinguishing characteristics |                                    | Shroud pins                              |                        |
| LID                                                  |                                    | Fabric                                   |                        |
| HEAD                                                 |                                    | Other finds                              |                        |
| BASE                                                 |                                    |                                          |                        |
| Recorder: <b>DM</b>                                  | Date: <b>04/12/00</b>              | Initials:                                |                        |

Site Code

Context

**Outer Coffin**

Sample Ret.

*2200*

*1118*

Recording Date ..... *13/12/00* .....

Associated Numbers .....

Condition .....

Dep. Plate

Legible

Inscription

Fabric lead  ormolou  brass  tin plated pewter  gilt tin   
 iron  silvered tin  enamelled  other ..... Sample Ret.

**Shape of dep. plate**

square  rectangle  shield  tapered  lozenge   
 cartouche  oval  other .....

**Upholstery**

colour ..... shoddy  velvet  other ..... Sample Ret.

**Construction**

butt joint  mitred  pitched  other .....

**Grip plate**

*Fabric = ormolou*  brass  tin plated pewter  gilt tin   
*Flag on rev of grip-wood.*

iron  silvered tin  enamelled  other ..... Sample Ret.

**Grip**

*Fabric = ormolou*  brass  iron  *x2* Sample Ret.

**Design**

swag of rose  horseshoe  cherub's head  *conc. (A)5* plain

other .....

**Grip bolts**

**Corner bolts**  Type = gilt brass  brass  iron

other ..... Sample Ret.

**Lid motifs**

other ..... Sample Ret.

**Escutcheons**

other ..... Sample Ret.

**Upholstery nails**

brass  gilt brass  silvered brass  iron  enamelled

other ..... Sample Ret.

**Fixings**

panel nails  screws  hinges  lace  Sample Ret.

**Timber type** .....

Sample Ret.

**Interpretation / Comments**

.....  
 .....

|                           |                                       |                                                         |
|---------------------------|---------------------------------------|---------------------------------------------------------|
| SITE<br>OLR 00            | COFFIN RECORD SHEET                   | CONTEXT NO.<br>1119                                     |
| Trench:                   | Additional sheets: <i>W/S X1</i>      | Treatment:<br><i>BONES LIFTED</i>                       |
| Site sub-div: <i>S.E.</i> | Grave fills                           |                                                         |
| Plan no.:<br><i>6</i>     | Grave cut:                            | Finds<br>None                                           |
| Section no:               | Skeleton:                             | Breastplate<br>Grip <input checked="" type="checkbox"/> |
| Co-ordinates:             | Matrix location:<br><i>O/L (1120)</i> | Hinge<br>Bracket                                        |
| Levels                    | Preservation:<br><i>POOR</i>          | Fixing nails<br>Shroud pins                             |
| Slide No.                 | Neg No:                               | Fabric<br>Other finds                                   |

**Description** E-W ADULT BURIAL. WOODEN COFFIN. ~~W~~  
 Fe STRAPWORK + Fe GRIPS.  
 TRUNCATED, POSSIBLY BY CUT FOR *(1119)*.

**Discussion** PARTIAL REPRESENTATION OF BONES - C. 50%

**Shape, dimensions and distinguishing characteristics**

LID  
 HEAD  
 BASE

Extra bones;  
 R+L Scapula  
 Atlas  
 3rd+4th cervical  
 2 thoracic  
 1st lumbar

} appear to be the same individual.  
 Adult.  
 Possibly ♀ (quite gracile)

|                     |                       |           |
|---------------------|-----------------------|-----------|
| Recorder: <i>BM</i> | Date: <i>04/12/00</i> | Initials: |
|---------------------|-----------------------|-----------|

# Coffin Recording Sheet

Site Code

Context

**Outer Coffin**

Sample Ret.

OL200

1119

Recording Date ..... *OL200 13/2/01* .....

Associated Numbers .....

Condition .....

Dep. Plate

Legible

Inscription

Fabric lead  ormolou  brass  tin plated pewter  gilt tin   
 iron  silvered tin  enamelled  other ..... Sample Ret.

**Shape of dep. plate**

square  rectangle  shield  tapered  lozenge   
 cartouche  oval  other .....

**Upholstery**

colour ..... shoddy  velvet  other ..... Sample Ret.

**Construction**

butt joint  mitred  pitched  other .....

**Grip plate**

Fabric = ormolou  brass  tin plated pewter  gilt tin   
 iron  *leags on rev. of grip - prob @ 200* silvered tin  enamelled  other ..... Sample Ret.

**Grip**

Fabric = ormolou  brass  iron  *x2 @ conc 4's.* Sample Ret.

**Design**

swag of rose  horseshoe  cherub's head  plain

other .....

**Grip bolts**

Corner bolts  Type = gilt brass  brass  iron

other ..... Sample Ret.

**Lid motifs**

other ..... Sample Ret.

**Escutcheons**

other ..... Sample Ret.

**Upholstery nails**

brass  gilt brass  silvered brass  iron  enamelled

other ..... Sample Ret.

**Fixings**

panel nails  screws  hinges  lace  Sample Ret.

**Timber type** .....

Sample Ret.

**Interpretation / Comments**

.....  
 .....

|                      |                                |                                                                                             |
|----------------------|--------------------------------|---------------------------------------------------------------------------------------------|
| SITE<br>OUR 00       | COFFIN RECORD SHEET            | CONTEXT NO.<br>1120                                                                         |
| Trench:              | Additional sheets:             | Treatment:<br>BONES LIFTED                                                                  |
| Site sub-div:<br>SR. | Grave fills:                   |                                                                                             |
| Plan no:<br>6        | Grave cut:                     | Finds:<br>None                                                                              |
| Section no:          | Skeleton:                      | Breastplate <input checked="" type="checkbox"/><br>Grip <input checked="" type="checkbox"/> |
| Co-ordinates:        | Matrix location:<br>V/L (1119) | Hinge<br>Bracket                                                                            |
| Levels:              | Preservation:<br>GOOD          | Fixing nails<br>Shroud pins                                                                 |
| Slide No.:           | Neg No.:                       | Fabric<br>Other finds                                                                       |

Description E-W ADULT BURIAL. WOODEN COFFIN.  
 Pb OUTER BREASTPLATE PRESENT BUT NOT RECOVERABLE  
 IN HEAD - VERY CORRODED AND DAMAGED.

Discussion Fe SMOKE + Fe GRIPS.

Shape, dimensions and distinguishing characteristics

Pb OUTER BREASTPLATE:

LID

HEAD

BASE

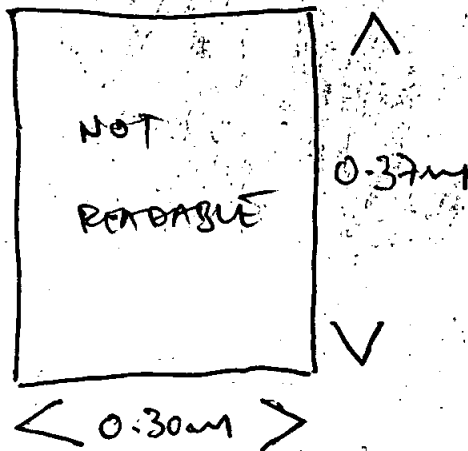

Recorder:

BM

Date:

04/12/00

Initials:



**Outer Coffin**

Sample Ret.

Site Code

Context

Recording Date ..... 22/2/00 .....

OKR00

1120

Associated Numbers .....

Condition ..... 1 .....

Dep. Plate

Legible  ISH

Inscription

"?/? Doherty/Died Aug<sup>st</sup> 20<sup>th</sup> 1818/Aged ? Years"  
new type see sheet.

Fabric lead  ormolou  brass  tin plated pewter  gilt tin   
iron  silvered tin  enamelled  other ..... Sample Ret.

**Shape of dep. plate**

square  rectangle  shield  tapered  lozenge   
cartouche  oval  other .....

**Upholstery**

colour ..... shoddy  velvet  other ..... Sample Ret.

**Construction** butt joint  mitred  pitched  other .....

**Grip plate**  Fabric = ormolou  brass  tin plated pewter  gilt tin   
iron  resonew of grip-wood silvered tin  enamelled  other ..... Sample Ret.

**Grip**  Fabric = ormolou  brass  iron  Sample Ret.

**Design** swag of rose  horseshoe  cherub's head  1x (A) plain   
other .....

**Grip bolts**  **Corner bolts**  **Type =** gilt brass  brass  iron   
other ..... Sample Ret.

**Lid motifs**  other ..... Sample Ret.

**Escutcheons**  other ..... Sample Ret.

**Upholstery nails**  brass  gilt brass  silvered brass  iron  enamelled   
other ..... Sample Ret.

**Fixings**  panel nails  screws  hinges  lace  Sample Ret.

**Timber type** ..... Sample Ret.

**Interpretation / Comments**

.....  
.....

| SITE               |  | COFFIN RECORD SHEET       |  | CONTEXT NO.  |  |
|--------------------|--|---------------------------|--|--------------|--|
| OUR 00             |  |                           |  | 1121         |  |
| Trench:            |  | Additional sheets: YES x1 |  | Treatment:   |  |
| Site sub-div: S.E. |  | Grave fills               |  | BONES LIFTED |  |
| Plan no: 6         |  | Grave cut:                |  | Finds        |  |
| Section no:        |  | Skeleton:                 |  | None         |  |
| Co-ordinates:      |  | Matrix location:          |  | Breastplate  |  |
| Levels             |  | Preservation: Poor        |  | Grip ✓       |  |
| Slide No.          |  | Neg No:                   |  | Hinge        |  |
|                    |  |                           |  | Bracket      |  |
|                    |  |                           |  | Fixing nails |  |
|                    |  |                           |  | Shroud pins  |  |
|                    |  |                           |  | Fabric       |  |
|                    |  |                           |  | Other finds  |  |

Description E-W ADULT BURIAL. WOODEN COFFIN. CW AND WY STROWER.  
 Fe-GRIP PRESENT.  
 HEAVILY TRUNCATED BURIAL - ONLY SKULL, SHOULDER PLATES  
 Discussion AND UPPER ARMS PRESENT.

Shape, dimensions and distinguishing characteristics

LID

HEAD

BASE

|              |                |           |
|--------------|----------------|-----------|
| Recorder: DM | Date: 04/12/00 | Initials: |
|--------------|----------------|-----------|

# Coffin Recording Sheet

**Outer Coffin**

Sample Ret.

Site Code

Context

07200

1121

Recording Date ..... 14/12/00 .....

Associated Numbers .....

Condition .....

Dep. Plate

Legible

Inscription

Fabric lead  ormolou  brass  tin plated pewter  gilt tin   
 iron  silvered tin  enamelled  other ..... Sample Ret.

**Shape of dep. plate**

square  rectangle  shield  tapered  lozenge   
 cartouche  oval  other .....

**Upholstery**

colour ..... shoddy  velvet  other ..... Sample Ret.

**Construction**

butt joint  mitred  pitched  other .....

Grip plate  Fabric = ormolou  brass  tin plated pewter  gilt tin   
 iron  silvered tin  enamelled  other ..... Sample Ret.

Grip  Fabric = ormolou  brass  iron  x1 Sample Ret.

Design swag of rose  horseshoe  cherub's head  (1) plain   
 other .....

Grip bolts  Corner bolts  Type = gilt brass  brass  iron   
 other ..... Sample Ret.

Lid motifs  other .....

Escutcheons  other .....

Upholstery <sup>studs</sup>  brass  gilt brass  silvered brass  iron  enamelled   
 other ..... x1 piece <sup>80</sup> = 4 studs total. Sample Ret.

Fixings  panel nails  screws  hinges  lace  Sample Ret.

Timber type ..... Sample Ret.

**Interpretation / Comments**

.....  
 .....

| SITE              |  | COFFIN RECORD SHEET |  | CONTEXT NO.                              |  |
|-------------------|--|---------------------|--|------------------------------------------|--|
| 0LR00             |  |                     |  | M22                                      |  |
| Trench:           |  | Additional sheets:  |  | Treatment:                               |  |
| Site sub-div: SR1 |  | Grave fills         |  | BONES LIFTED                             |  |
| Plan no: 6        |  | Grave cut:          |  | Finds                                    |  |
| Section no:       |  | Skeleton:           |  | None                                     |  |
| Co-ordinates:     |  | Matrix location:    |  | Breastplate                              |  |
| Levels            |  | Preservation: Good  |  | Grip <input checked="" type="checkbox"/> |  |
| Slide No.         |  | Neg No:             |  | Hinge                                    |  |
|                   |  |                     |  | Bracket                                  |  |
|                   |  |                     |  | Fixing nails                             |  |
|                   |  |                     |  | Shroud pins                              |  |
|                   |  |                     |  | Fabric                                   |  |
|                   |  |                     |  | Other finds                              |  |

**Description** E-W INFANT BURIAL. WOODEN COFFIN  
 W ANOP STUDWORK. FE GRIPS PRESENT.

**Discussion**

**Shape, dimensions and distinguishing characteristics**

**LID**

**HEAD**

**BASE**

|              |                |           |
|--------------|----------------|-----------|
| Recorder: DM | Date: 04/12/00 | Initials: |
|--------------|----------------|-----------|

|                             |                                       |                                                         |
|-----------------------------|---------------------------------------|---------------------------------------------------------|
| SITE<br>OLR 00              | COFFIN RECORD SHEET                   | CONTEXT NO.<br>1123                                     |
| Trench:                     | Additional sheets: <i>W3X1</i>        | Treatment:<br><i>BONES LIFTED</i>                       |
| Site sub-div:<br><i>se.</i> | Grave fills                           |                                                         |
| Plan no:<br><i>6</i>        | Grave cut:                            | Finds<br>None                                           |
| Section no:                 | Skeleton:                             | Breastplate<br>Grip <input checked="" type="checkbox"/> |
| Co-ordinates:               | Matrix location:<br><i>V/L (1122)</i> | Hinge<br>Bracket                                        |
| Levels                      | Preservation:<br><i>GOOD</i>          | Fixing nails<br>Shroud pins                             |
| Slide No.                   | Neg No:                               | Fabric<br>Other finds                                   |

Description *E-W INFANT BURIAL. WOODEN COFFIN.  
Fe GRIPS PRESENT.*

Discussion

Shape, dimensions and distinguishing characteristics

LID

HEAD

BASE

|                        |                          |           |
|------------------------|--------------------------|-----------|
| Recorder:<br><i>DM</i> | Date:<br><i>04/12/00</i> | Initials: |
|------------------------|--------------------------|-----------|

# Coffin Recording Sheet

Site Code

Context

**Outer Coffin**

Sample Ret.

Recording Date ..... 13/2/01 .....

Associated Numbers .....

Condition .....

Dep. Plate

Legible

Inscription

Fabric lead  ormolou  brass  tin plated pewter  gilt tin   
 iron  silvered tin  enamelled  other ..... Sample Ret.

**Shape of dep. plate**

square  rectangle  shield  tapered  lozenge   
 cartouche  oval  other .....

**Upholstery**

colour ..... shoddy  velvet  other ..... Sample Ret.

**Construction**

butt joint  mitred  pitched  other .....

**Grip plate**  Fabric = ormolou  brass  tin plated pewter  gilt tin   
 iron  silvered tin  enamelled  other ..... Sample Ret.

**Grip**  Fabric = ormolou  brass  iron  x1 Sample Ret.

**Design** swag of rose  horseshoe  cherub's head  plain   
 other ..... *infant ① ← 0.10 ↓ 0.05*

**Grip bolts**  **Corner bolts**  **Type =** gilt brass  brass  iron   
 other ..... Sample Ret.

**Lid motifs**  other ..... Sample Ret.

**Escutcheons**  other ..... Sample Ret.

**Upholstery nails**  brass  gilt brass  silvered brass  iron  enamelled   
 other ..... Sample Ret.

**Fixings**  panel nails  screws  hinges  lace  Sample Ret.

**Timber type** ..... Sample Ret.

**Interpretation / Comments**

.....  
 .....

26

|                         |                                                        |                                |                         |
|-------------------------|--------------------------------------------------------|--------------------------------|-------------------------|
| SITE <b>OUR 00</b>      |                                                        | COFFIN RECORD SHEET            | CONTEXT NO. <b>1124</b> |
| Trench:                 | Additional sheets:                                     | Treatment: <b>BONES LIFTED</b> |                         |
| Site sub-div: <b>SC</b> | Grave fills:                                           |                                |                         |
| Plan no: <b>6</b>       | Grave cut:                                             | Finds<br>None                  |                         |
| Section no:             | Skeleton:                                              | Breastplate<br>Grip            |                         |
| Co-ordinates:           | Matrix location:<br><b>V/L 1123</b><br><b>O/L 1158</b> | Hinge<br>Bracket               |                         |
| Levels:                 | Preservation:                                          | Fixing nails<br>Shroud pins    |                         |
| Slide No.:              | Neg No.:                                               | Fabric<br>Other finds          |                         |

Description **E-W ADULT BURIAL. WOODEN COFFIN.**

Discussion

Shape, dimensions and distinguishing characteristics

LID

HEAD

BASE

|                     |                       |           |
|---------------------|-----------------------|-----------|
| Recorder: <b>BM</b> | Date: <b>05/12/00</b> | Initials: |
|---------------------|-----------------------|-----------|

|                            |                                                                        |                                   |
|----------------------------|------------------------------------------------------------------------|-----------------------------------|
| SITE<br>2200               | COFFIN RECORD SHEET                                                    | CONTEXT NO.<br>1125               |
| Trench:                    | Additional sheets:                                                     | Treatment:<br>INTACT → NECROPHOUS |
| Site sub-div:<br>CAMP SANZ | Grave fills:                                                           |                                   |
| Plan no:<br>7.             | Grave cut:                                                             | Finds<br>None ✓                   |
| Section no:                | Skeleton:                                                              | Breastplate<br>Grip               |
| Co-ordinates:              | Matrix location:                                                       | Hinge<br>Bracket                  |
| Levels                     | Preservation:<br>SLIGHTLY CORRODED AT<br>FOOT BUT INNER WOOD<br>INTACT | Fixing nails<br>Shroud pins       |
| Slide No.                  | Neg No:                                                                | Fabric<br>Other finds             |

Description Pb NORTH-SOUTH ~~SEA~~ INFANT COFFIN

Discussion

Shape, dimensions and distinguishing characteristics

LID

Mrs James  
Edw. Dudley  
Died 21 May  
1841  
Aged 2y<sup>rs</sup> 6 M<sup>ns</sup>.

HEAD

BASE

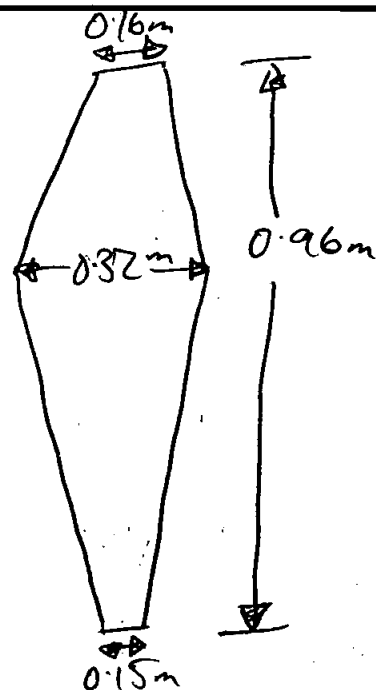

DEPTH = 0.26m

|                 |                   |           |
|-----------------|-------------------|-----------|
| Recorder:<br>TB | Date:<br>1.12.00. | Initials: |
|-----------------|-------------------|-----------|



| SITE                         | COFFIN RECORD SHEET                                  | CONTEXT NO.                  |
|------------------------------|------------------------------------------------------|------------------------------|
| 02R00                        |                                                      | 1126.                        |
| Trench:                      | Additional sheets:                                   | Treatment:                   |
| Site sub-div: <i>CMT 547</i> | Grave fills                                          | <i>BONES LIFTED. NO DATA</i> |
| Plan no: <i>7.</i>           | Grave cut:                                           | Finds                        |
| Section no:                  | Skeleton:                                            | None                         |
| Co-ordinates:                | Matrix location: <i>1/2 845</i>                      | Breastplate                  |
| Levels                       | Preservation: <i>POOR - CORRODED/SPLIT/SQUASHED.</i> | Grip                         |
| Slide No.                    | Neg No:                                              | Hinge                        |
|                              |                                                      | Bracket                      |
|                              |                                                      | Fixing nails                 |
|                              |                                                      | Shroud pins                  |
|                              |                                                      | Fabric                       |
|                              |                                                      | Other finds                  |

Description *EAST-WEST INFANT Pb COFFIN.*

Discussion

Shape, dimensions and distinguishing characteristics

*SOLDERED Pb PLATE ON COFFIN: -*

LID

*M,fs*

HEAD

*Eliza Judley  
Died 24<sup>th</sup> Nov  
1848*

BASE

*Ag 10 Mon  
3 Weeks.*

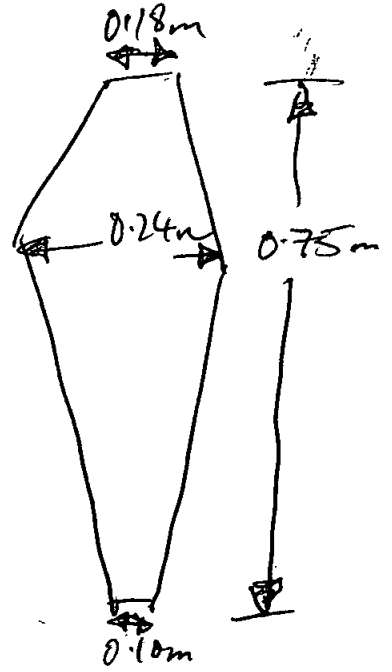

*DEPTH - 20.15m*

|                     |                       |           |
|---------------------|-----------------------|-----------|
| Recorder: <i>Pm</i> | Date: <i>1.12.00.</i> | Initials: |
|---------------------|-----------------------|-----------|

|                        |                                           |                             |
|------------------------|-------------------------------------------|-----------------------------|
| SITE<br>02100          | COFFIN RECORD SHEET                       | CONTEXT NO.<br>1127         |
| Trench:                | Additional sheets:                        | Treatment:                  |
| Site sub-div:<br>CAMPT | Grave fills:                              | D Weelof.                   |
| Plan no:<br>7          | Grave cut:                                |                             |
| Section no:            | Skeleton:                                 | Finds<br>None               |
| Co-ordinates:          | Matrix location:<br>Bay 24<br>adj to 1123 | Breastplate<br>Grip         |
| Levels:                | Preservation:                             | Hinge<br>Bracket            |
| Slide No.              | Neg No:                                   | Fixing nails<br>Shroud pins |
|                        |                                           | Fabric<br>Other finds       |

Description *infant p.b. coffin.*  
*EAST - WEST*

Discussion

Shape, dimensions and distinguishing characteristics

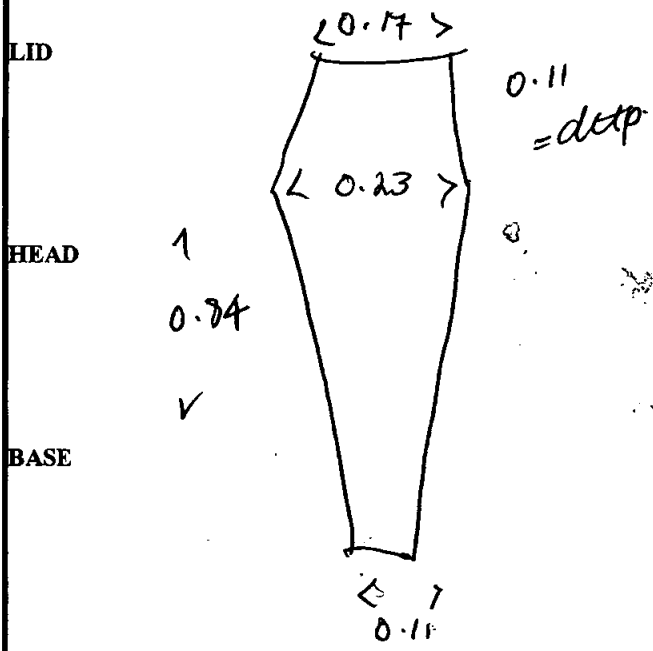

*Miss Matilda Bonnelly*  
~~Bonnelly~~  
*Died 27 April*  
*1822 Aged 2 Years*  
*& 4 Months*

|                              |                  |           |
|------------------------------|------------------|-----------|
| Recorder:<br><i>M. D. J.</i> | Date:<br>1.12.00 | Initials: |
|------------------------------|------------------|-----------|

| SITE OR 200         |                                        | COFFIN RECORD SHEET    |  | CONTEXT NO. 1128      |  |
|---------------------|----------------------------------------|------------------------|--|-----------------------|--|
| Trench:             | Additional sheets: 4E2XL.              | Treatment: DATA/BONES. |  | <del>XXXXXXXXXX</del> |  |
| Site sub-div: CRYPT | Grave fills                            | Finds                  |  | None                  |  |
| Plan no: 7          | Grave cut:                             | Breastplate            |  | ✓ (20) Cu alloy       |  |
| Section no:         | Skeleton:                              | Grip                   |  | inscript (6)          |  |
| Co-ordinates:       | Matrix location: Bay 2<br>adj. to 1089 | Hinge                  |  | Esutchcon. Cu alloy   |  |
| Levels              | Preservation: Good.                    | Bracket                |  | studs.                |  |
| Slide No.           | Neg No:                                | Fixing nails           |  | Shroud pins           |  |
|                     |                                        | Fabric                 |  | Other finds           |  |

**Description** ADULT to coffin  
EAST-WEST  
BRANDED

**Discussion**

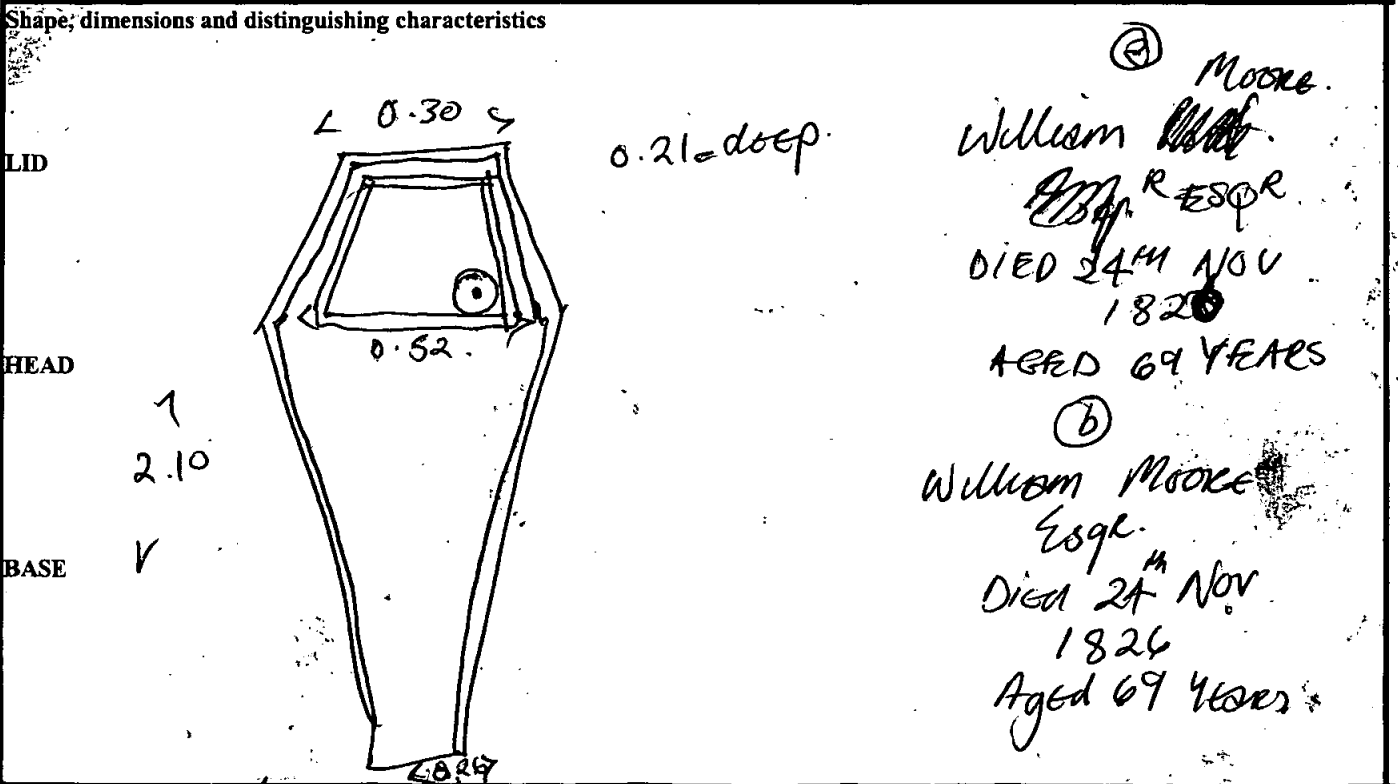

|                  |               |           |
|------------------|---------------|-----------|
| Recorder: JM/mel | Date: 1.12.00 | Initials: |
|------------------|---------------|-----------|

**Outer Coffin**

Sample Ret.

Site Code

Context

Recording Date ..... 4/12/00

0200

1128

Associated Numbers .....

Condition ..... 4

Dep. Plate

Legible

Inscription "William Moore/ESQ/DIED 24th NOV/1826/AGED 69 YEARS"

20

Fabric lead  ormolou  brass  tin plated pewter  gilt tin   
 iron  silvered tin  enamelled  other ..... Sample Ret.

**Shape of dep. plate**

square  rectangle  shield  tapered  lozenge   
 cartouche  oval  other .....

**Upholstery**

colour ..... shoddy  velvet  other *Beats* ..... Sample Ret.

**Construction** butt joint  mitred  pitched  other .....

**Grip plate**  Fabric = ormolou  brass  tin plated pewter  gilt tin   
 iron  silvered tin  enamelled  other ..... Sample Ret.

**Grip**  Fabric = ormolou  brass  iron  Sample Ret.

**Design** swag of rose  horseshoe  cherub's head  plain   
 other .....

**Grip bolts**  **Corner bolts**  Type = gilt brass  brass  iron   
 other ..... Sample Ret.

**Lid motifs**  other ..... Sample Ret.

**Escutcheons**  other *cu alloy w/ traces of gilt remaining x 2 (6)'s* ..... Sample Ret.

**Upholstery** <sup>sheds</sup> ~~bits~~  brass  gilt brass  silvered brass  iron  enamelled   
 other *mony in situ: db inner row = 5m; outer ring row = 1gal* ..... Sample Ret.

**Fixings**  panel nails  screws  hinges  lace  Sample Ret.

**Timber type** ..... Sample Ret.

**Interpretation / Comments**

.....  
 .....

# Coffin Recording Sheet

Site Code

Context

**Outer Coffin**

Sample Ret.

0h200

1128

Recording Date ..... 15/2/01 .....

Associated Numbers .....

Condition .....

Dep. Plate

Legible

Inscription

Fabric lead  ormolou  brass  tin plated pewter  gilt tin   
 iron  silvered tin  enamelled  other ..... Sample Ret.

**Shape of dep. plate**

square  rectangle  shield  tapered  lozenge   
 cartouche  oval  other .....

**Upholstery**

colour ..... shoddy  velvet  other ..... Sample Ret.

**Construction**

butt joint  mitred  pitched  other .....

Grip plate  Fabric = ormolou  brass  X1 tin plated pewter  gilt tin   
 iron  silvered tin  enamelled  other ..... Sample Ret.

Grip  Fabric = ormolou  brass  4 iron  Sample Ret.

Design swag of rose  horseshoe  cherub's head  plain   
 other .....

Grip bolts  Corner bolts  Type = gilt brass  brass  iron   
 other ..... Sample Ret.

Lid motifs  other ..... Sample Ret.

Escutcheons  other ..... Sample Ret.

Upholstery nails  brass  gilt brass  silvered brass  iron  enamelled   
 other ..... Sample Ret.

Fixings  panel nails  screws  hinges  lace  Sample Ret.

Timber type ..... Sample Ret.

**Interpretation / Comments**

.....  
 .....

| SITE <i>Ohlsoo</i>         |                                           | COFFIN RECORD SHEET | CONTEXT NO. <i>129</i> |
|----------------------------|-------------------------------------------|---------------------|------------------------|
| Trench:                    | Additional sheets:                        | Treatment:          |                        |
| Site sub-div: <i>CRYPT</i> | Grave fills                               | <i>→ Necrop.</i>    |                        |
| Plan no: <i>7</i>          | Grave cut:                                | Finds               |                        |
| Section no:                | Skeleton:                                 | None                |                        |
| Co-ordinates:              | Matrix location: <i>Box 2 adj to 1089</i> | Breastplate         |                        |
| Levels                     | Preservation:                             | Grip <i>⊙ x 1</i>   |                        |
| Slide No.                  | Neg No:                                   | Hinge               |                        |
|                            |                                           | Bracket             |                        |
|                            |                                           | Fixing nails        |                        |
|                            |                                           | Shroud pins         |                        |
|                            |                                           | Fabric              |                        |
|                            |                                           | Other finds         |                        |

**Description** *adult pb coffin, un-named.*  
*WCS - G35*

**Discussion**

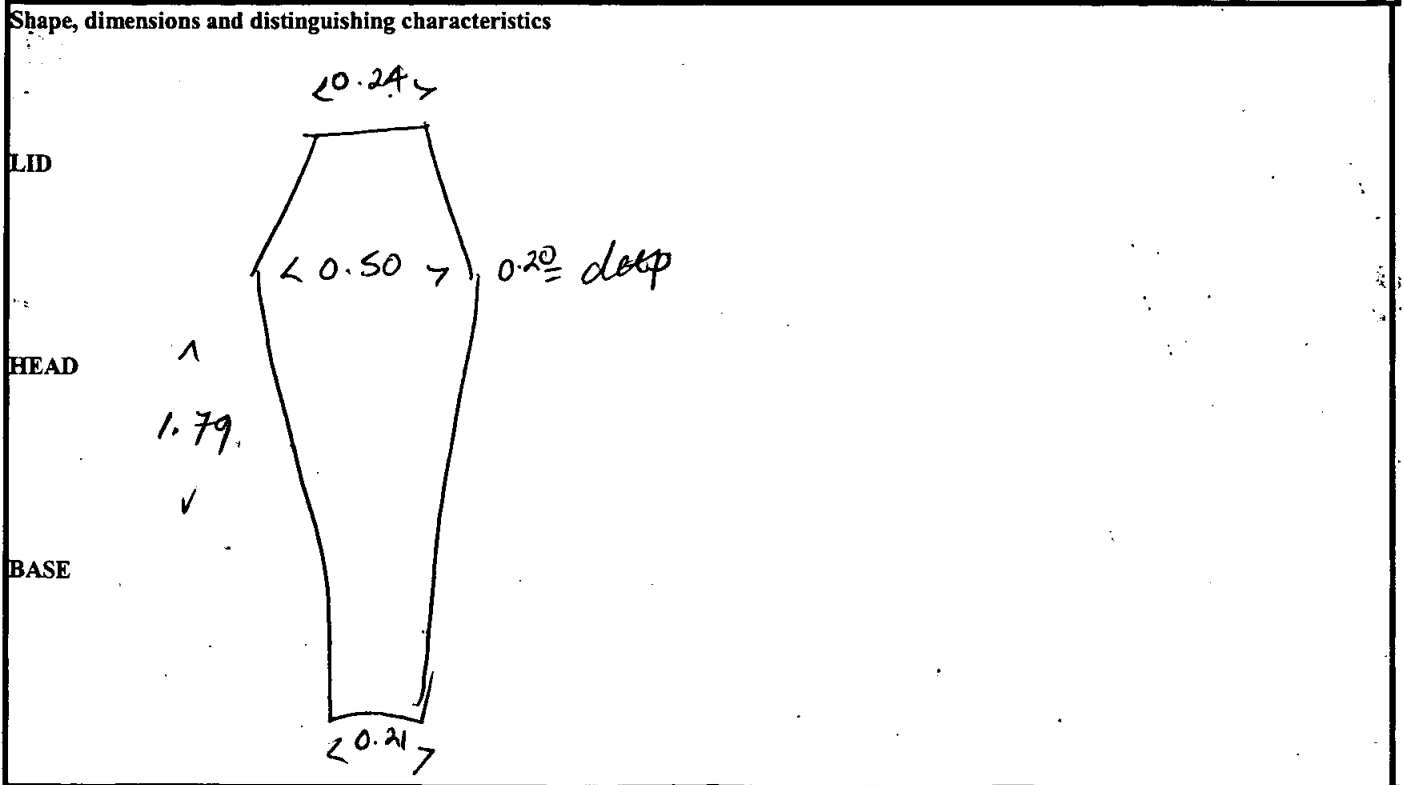

|                         |                      |           |
|-------------------------|----------------------|-----------|
| Recorder: <i>DM Mel</i> | Date: <i>1.12.00</i> | Initials: |
|-------------------------|----------------------|-----------|

|                                   |                                  |                                                   |
|-----------------------------------|----------------------------------|---------------------------------------------------|
| SITE<br><i>02100</i>              | COFFIN RECORD SHEET              | CONTEXT NO.<br><i>1130</i>                        |
| Trench:                           | Additional sheets: <i>YES 02</i> | Treatment:                                        |
| Site sub-div:<br><i>CAMP S444</i> | Grave fills                      | <i>→ NECRSP.</i>                                  |
| Plan no:<br><i>7.</i>             | Grave cut:                       | Finds<br>None <input checked="" type="checkbox"/> |
| Section no:                       | Skeleton:                        | Breastplate<br>Grip                               |
| Co-ordinates:                     | Matrix location: <i>Box 2.</i>   | Hinge<br>Bracket                                  |
| Levels                            | Preservation: <i>Good</i>        | Fixing nails<br>Shroud pins                       |
| Slide No.                         | Neg No:                          | Fabric<br>Other finds                             |

Description *adult p.b. coffin*  
*WEST - EAST*

Discussion

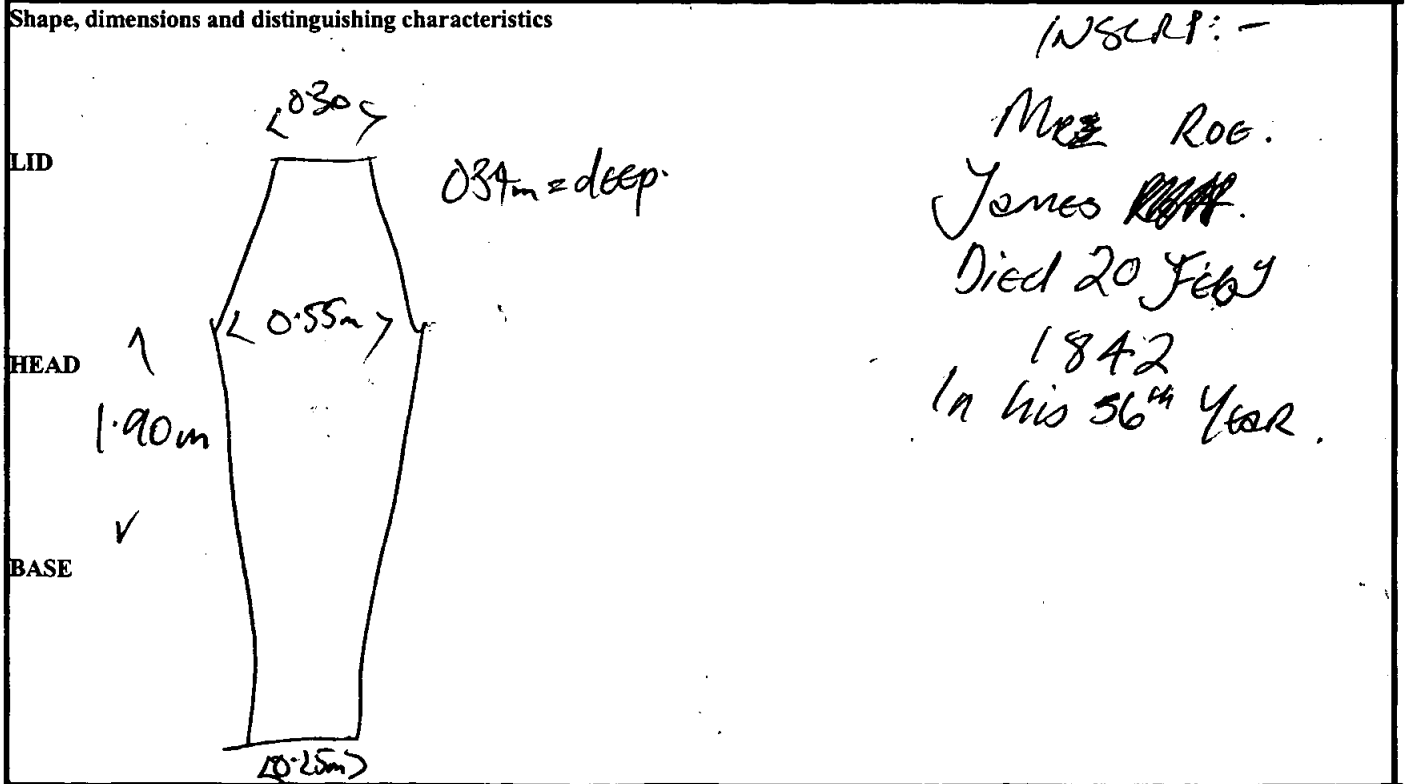

|                                   |                      |           |
|-----------------------------------|----------------------|-----------|
| Recorder: <i>Mel / [initials]</i> | Date: <i>1.12.00</i> | Initials: |
|-----------------------------------|----------------------|-----------|

Site Code

Context

**Outer Coffin**

Sample Ret.

OR00

1130

Recording Date ..... 4/12/00 .....

Associated Numbers .....

Condition ..... 2 .....

Dep. Plate

Legible

Inscription "Mr/James Roe/Died 20<sup>th</sup> Feb/1812/In his 56<sup>th</sup> Year"

Fabric lead  ormolou  brass  tin plated pewter  gilt tin   
 iron  silvered tin  enamelled  other ..... Sample Ret.

*black polished*  
*Makes Marks:*  
*bottom RHS: OCT 21 1839*  
*bottom LHS: NO. HANDS.?? 160*

Shape of dep. plate  
 square  rectangle  shield  tapered  lozenge   
 cartouche  oval  other .....

Upholstery   
 colour ..... shoddy  velvet  other ..... Sample Ret.

Construction  
 butt joint  mitred  pitched  other .....

Grip plate  Fabric = ormolou  brass  tin plated pewter  gilt tin   
 iron  silvered tin  enamelled  other ..... Sample Ret.

Grip  Fabric = ormolou  brass  iron  Sample Ret.

Design  
 swag of rose  horseshoe  cherub's head  plain   
 other .....

Grip bolts  Corner bolts  Type = gilt brass  brass  iron   
 other ..... Sample Ret.

Lid motifs  other ..... Sample Ret.

Escutcheons  other ..... Sample Ret.

Upholstery nails  brass  gilt brass  silvered brass  iron  enamelled   
 other ..... Sample Ret.

Fixings  panel nails  screws  hinges  lace  Sample Ret.

Timber type ..... Sample Ret.

Interpretation / Comments

.....  
 .....



|                              |                       |                                                  |
|------------------------------|-----------------------|--------------------------------------------------|
| SITE<br>OLR00.               | COFFIN RECORD SHEET   | CONTEXT NO.<br>1131                              |
| Trench:                      | Additional sheets:    | Treatment:<br>DNA/BONES.<br><del>NO RECORD</del> |
| Site sub-div:<br>COTTON BANK | Grave fills           |                                                  |
| Plan no:<br>7                | Grave cut:            | Finds<br>None<br>inscrip $\diamond$ board.       |
| Section no:                  | Skeleton:             | Breastplate<br>Grip                              |
| Co-ordinates:                | Matrix location:      | Hinge<br>Bracket                                 |
| Levels                       | Preservation:<br>GOOD | Fixing nails<br>Shroud pins                      |
| Slide No.                    | Neg No:               | Fabric<br>Other finds                            |

Description  
ADULT P3 COFFIN.  
WEST - EAST.

Discussion

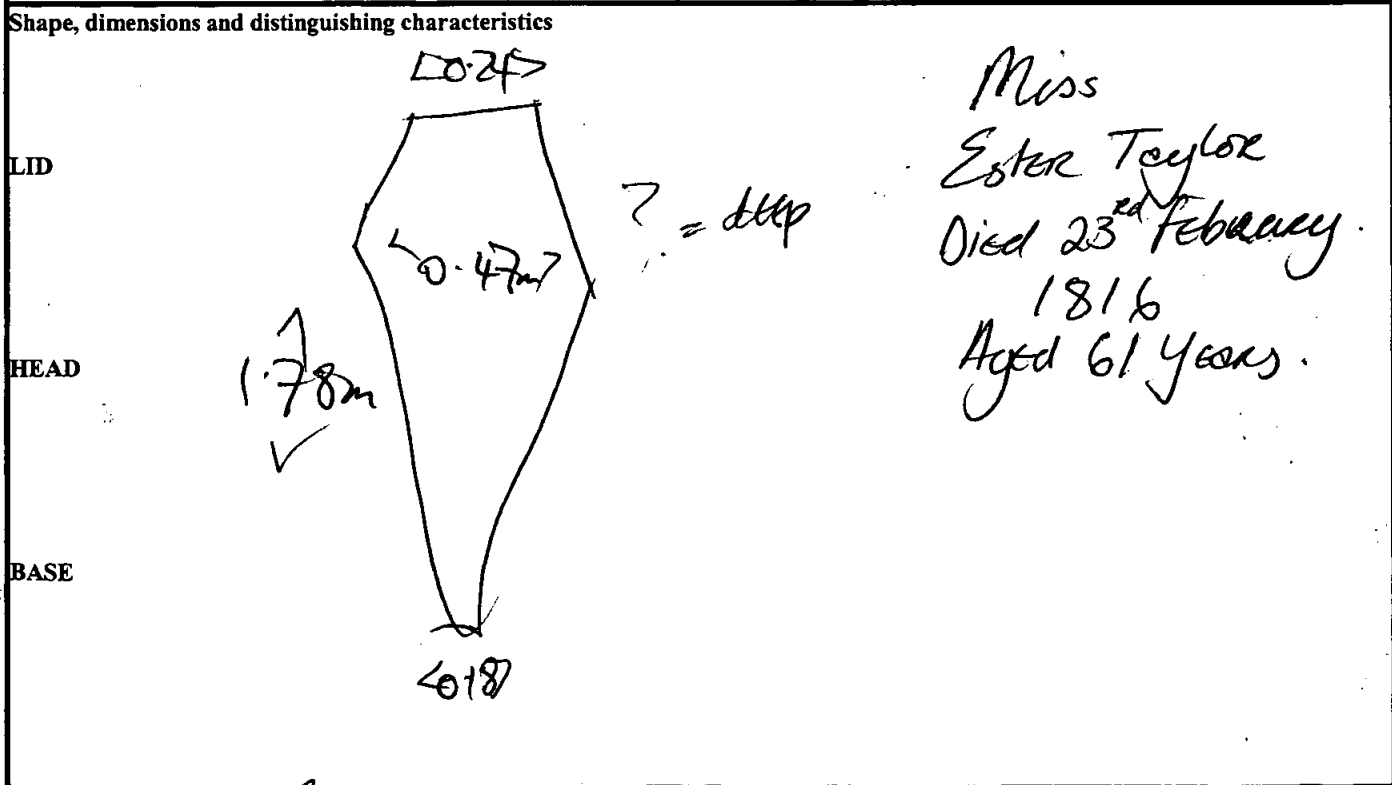

|                          |                  |           |
|--------------------------|------------------|-----------|
| Recorder:<br>[Signature] | Date:<br>1.12.00 | Initials: |
|--------------------------|------------------|-----------|

| SITE                     |  | COFFIN RECORD SHEET       |  | CONTEXT NO.                                   |  |
|--------------------------|--|---------------------------|--|-----------------------------------------------|--|
| 01100                    |  |                           |  | 1132                                          |  |
| Trench:                  |  | Additional sheets: YES x1 |  | Treatment:                                    |  |
| Site sub-div: CAVE BAY 4 |  | Grave fills               |  | - NO COP.                                     |  |
| Plan no: 7               |  | Grave cut:                |  | Finds                                         |  |
| Section no:              |  | Skeleton:                 |  | None                                          |  |
| Co-ordinates:            |  | Matrix location:          |  | Breastplate ✓<br>Inscrip (C)<br>Grip ✓ 1x (C) |  |
| Levels                   |  | Preservation: GOOD        |  | Hinge                                         |  |
| Slide No.                |  | Neg No:                   |  | Bracket                                       |  |
|                          |  |                           |  | Fixing nails                                  |  |
|                          |  |                           |  | Shroud pins                                   |  |
|                          |  |                           |  | Fabric                                        |  |
|                          |  |                           |  | Other finds                                   |  |

**Description**  
ADULT M  
WEST - CAST

**Discussion**

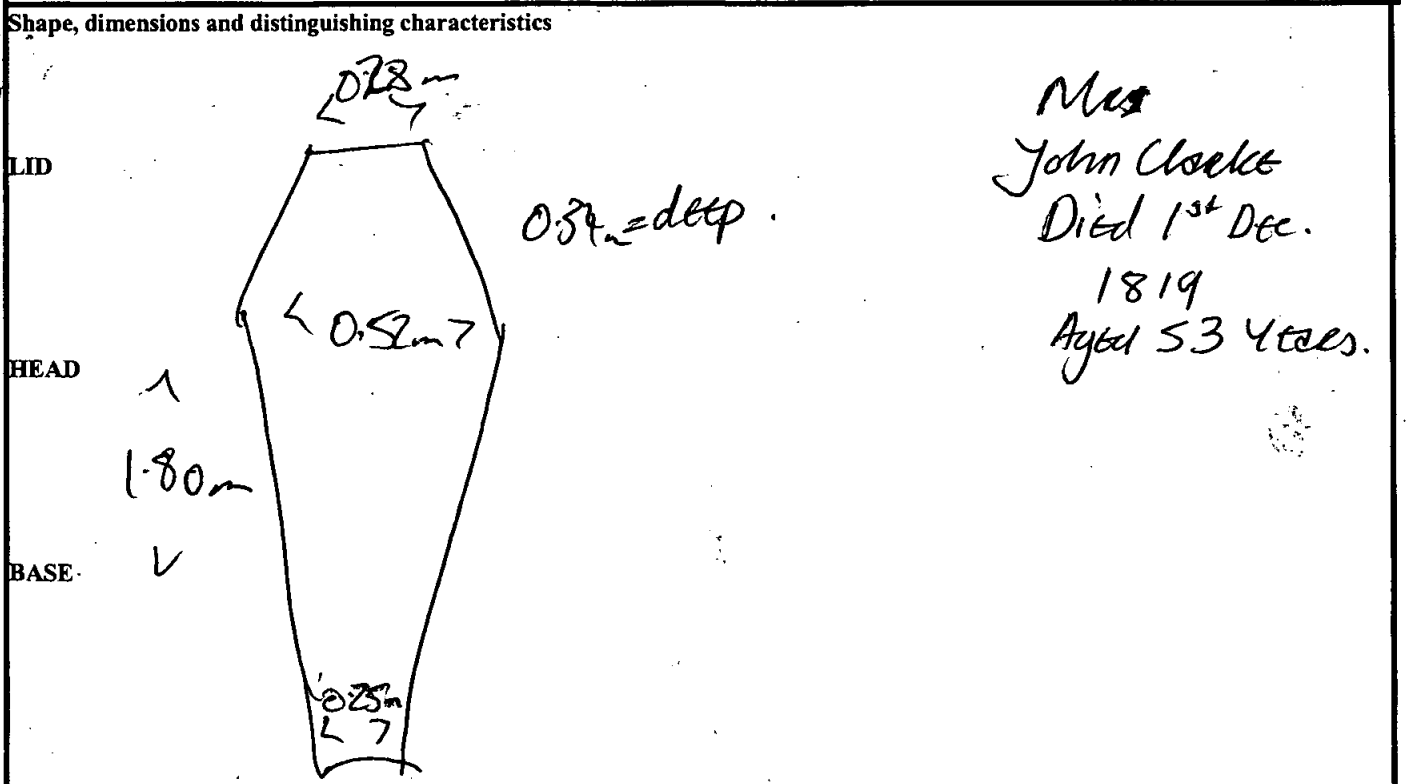

|                  |               |           |
|------------------|---------------|-----------|
| Recorder: B. Mel | Date: 1.17.00 | Initials: |
|------------------|---------------|-----------|

Site Code

Context

**Outer Coffin**

Sample Ret.

0200

1132

Recording Date ..... 13/12/00

Associated Numbers .....

Condition ..... 3

Dep. Plate

Legible

Inscription *Mr John Clarke / Died 1<sup>st</sup> Dec<sup>r</sup> / 1819 / Aged 53 Years*  
*same as 393 w/ 253 inner border & new outer border.*

Fabric lead  ormolou  brass  tin plated pewter  gilt tin   
 iron  silvered tin  enamelled  other ..... Sample Ret.

*black polished*

**Shape of dep. plate**

square  rectangle  shield  tapered  lozenge   
 cartouche  oval  other .....

**Upholstery**

colour ..... shoddy  velvet  other ..... Sample Ret.

**Construction**

butt joint  mitred  pitched  other .....

**Grip plate**

Fabric = ormolou  brass  tin plated pewter  gilt tin   
 iron  silvered tin  enamelled  other ..... Sample Ret.

**Grip**

Fabric = ormolou  brass  iron  Sample Ret.

**Design**

swag of rose  horseshoe  cherub's head  plain   
 other .....

**Grip bolts**

Corner bolts  Type = gilt brass  brass  iron   
 other ..... Sample Ret.

**Lid motifs**

other ..... Sample Ret.

**Escutcheons**

other ..... Sample Ret.

**Upholstery nails**

brass  gilt brass  silvered brass  iron  enamelled   
 other ..... Sample Ret.

**Fixings**

panel nails  screws  hinges  lace  Sample Ret.

**Timber type** .....

Sample Ret.

**Interpretation / Comments**

.....  
 .....

| SITE                | COFFIN RECORD SHEET                      | CONTEXT NO.                                                                                     |
|---------------------|------------------------------------------|-------------------------------------------------------------------------------------------------|
| 07200               |                                          | 1133                                                                                            |
| Trench:             | Additional sheets: YES x1                | Treatment:                                                                                      |
| Site sub-div: CRYP1 | Grave fills                              | DNECLOS.                                                                                        |
| Plan no: 7          | Grave cut:                               | Finds                                                                                           |
| Section no:         | Skeleton:                                | None                                                                                            |
| Co-ordinates:       | Matrix location: in Bay 2<br>adj to 1132 | Breastplate <input checked="" type="checkbox"/><br>Grip <input checked="" type="checkbox"/> (2) |
| Levels              | Preservation: GOOD.                      | Hinge                                                                                           |
| Slide No.           | Neg No:                                  | Bracket                                                                                         |
|                     |                                          | Fixing nails                                                                                    |
|                     |                                          | Shroud pins                                                                                     |
|                     |                                          | Fabric                                                                                          |
|                     |                                          | Other finds                                                                                     |

**Description** adult p.b. coffin  
EAST-WEST.

**Discussion**

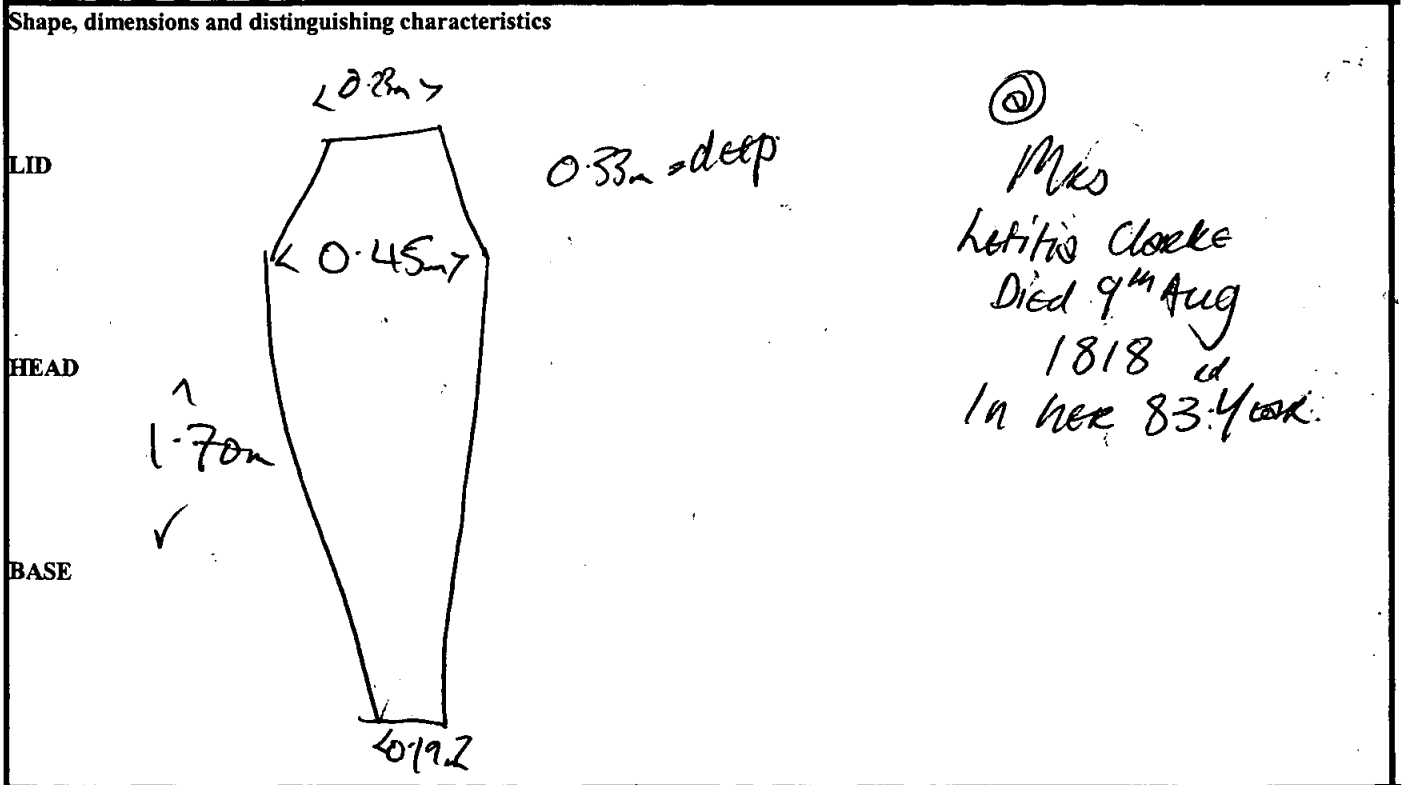

|                 |               |           |
|-----------------|---------------|-----------|
| Recorder: Jm Md | Date: 1.12.80 | Initials: |
|-----------------|---------------|-----------|

Outer Coffin

Sample Ret.

Site Code

Context

Recording Date 4/12/00

**0200**

**1133**

Associated Numbers .....

Condition 3

Dep. Plate

Legible

*head/foot plate.*

Inscription *"Mrs Letitia Clarke / Died 9<sup>th</sup> Aug<sup>st</sup> / 1818 / In her 85<sup>th</sup> year" \*  
x1 \**

**(82)** *w/ new border.*

Fabric lead  ormolou  brass  tin plated pewter  gilt tin   
iron  silvered tin  enamelled  other ..... Sample Ret.

**Shape of dep. plate**

square  rectangle  shield  tapered  lozenge   
cartouche  oval  other .....

*Black polished.*

**Upholstery**

colour ..... shoddy  velvet  other ..... Sample Ret.

**Construction**

butt joint  mitred  pitched  other .....

**Grip plate**

Fabric = ormolou  brass  tin plated pewter  gilt tin

iron  silvered tin  enamelled  other ..... Sample Ret.

**Grip**

Fabric = ormolou  brass  iron  Sample Ret.

**Design**

swag of rose  horseshoe  cherub's head  plain

other .....

**Grip bolts**

Corner bolts  Type = gilt brass  brass  iron

other ..... Sample Ret.

**Lid motifs**

other .....

Sample Ret.

**Escutcheons**

other .....

Sample Ret.

**Upholstery nails**

brass  gilt brass  silvered brass  iron  enamelled

other ..... Sample Ret.

**Fixings**

panel nails  screws  hinges  lace  Sample Ret.

**Timber type** .....

Sample Ret.

**Interpretation / Comments**

*\* Mrs Letitia Clarke / Died 9<sup>th</sup> August / 1818  
(plain text)*

| SITE                       |                                  | COFFIN RECORD SHEET |  | CONTEXT NO. |  |
|----------------------------|----------------------------------|---------------------|--|-------------|--|
| OLR00.                     |                                  |                     |  | 1134        |  |
| Trench:                    | Additional sheets:               | Treatment:          |  |             |  |
| Site sub-div:<br>CAMP BANZ | Grave fills                      | D NEKROP.           |  |             |  |
| Plan no:<br>7              | Grave cut:                       | Finds               |  |             |  |
| Section no:                | Skeleton:                        | None ✓              |  |             |  |
| Co-ordinates:              | Matrix location:                 | Breastplate         |  |             |  |
| Levels                     | Preservation: SLIGHTLY CORRODED. | Grip                |  |             |  |
| Slide No.                  | Neg No:                          | Hinge               |  |             |  |
|                            |                                  | Bracket             |  |             |  |
|                            |                                  | Fixing nails        |  |             |  |
|                            |                                  | Shroud pins         |  |             |  |
|                            |                                  | Fabric              |  |             |  |
|                            |                                  | Other finds         |  |             |  |

Description Pb INFANT COFFIN  
WEST-EAST ALIGNED.

Discussion

Shape, dimensions and distinguishing characteristics

LID  
 INSCRIPTION: -  
 (Badly Corroded)  
 Mast' John  
 Wright  
 HEAD  
 BASE

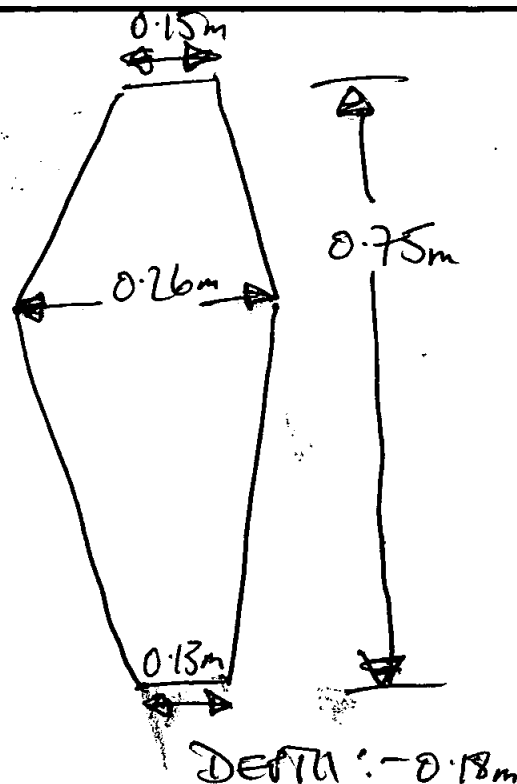

|             |               |           |
|-------------|---------------|-----------|
| Recorder: B | Date: 4.12.00 | Initials: |
|-------------|---------------|-----------|

| SITE                       |                    | COFFIN RECORD SHEET | CONTEXT NO. |
|----------------------------|--------------------|---------------------|-------------|
| 0200.                      |                    |                     | 1135.       |
| Trench:                    | Additional sheets: | Treatment:          |             |
| Site sub-div:<br>CRUT BANZ | Grave fills        | Bones/DNA           |             |
| Plan no:<br>7.             | Grave cut:         | Finds               |             |
| Section no:                | Skeleton:          | None <del>and</del> |             |
| Co-ordinates:              | Matrix location:   | Breastplate ✓       |             |
| Levels                     | Preservation:      | Grip                |             |
| Slide No.                  | Neg No:            | Hinge               |             |
|                            |                    | Bracket             |             |
|                            |                    | Fixing nails        |             |
|                            |                    | Shroud pins         |             |
|                            |                    | Fabric              |             |
|                            |                    | Other finds         |             |

**Description** Adult Pb Coffin  
EAST-WEST ALIGNED.  
BRANCHED.

**Discussion**

**INSCRIPTION:-**  
MRS  
Susanna Wright  
Died 26<sup>th</sup> April  
1849  
Aged 65 Years.

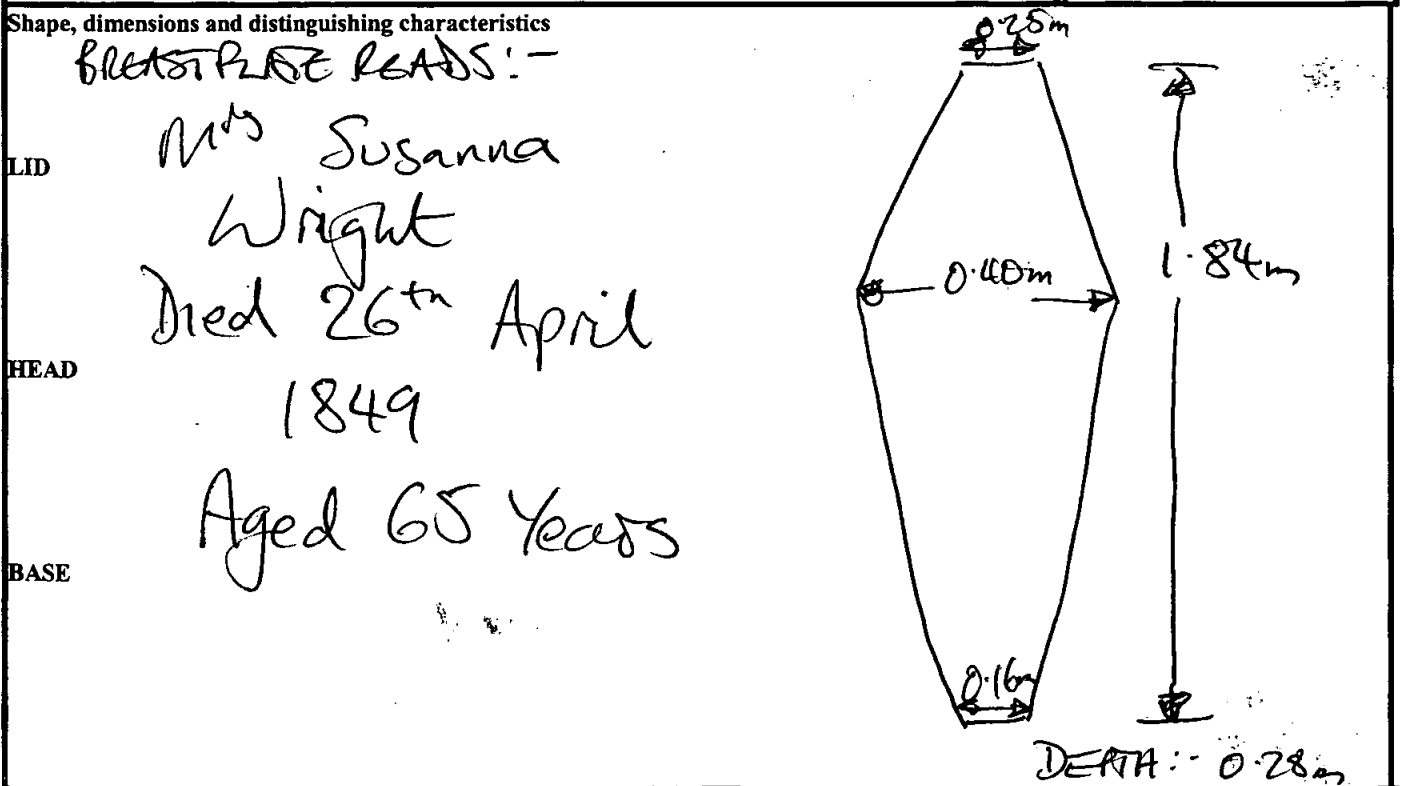

|             |                |           |
|-------------|----------------|-----------|
| Recorder: M | Date: 4.12.00. | Initials: |
|-------------|----------------|-----------|

# Coffin Recording Sheet

**Outer Coffin**

Sample Ret.

Site Code

Context

OR00

1135

Recording Date ..... 15/2/01 .....

Associated Numbers .....

Condition ..... 3 .....

Dep. Plate

Legible

*new type:*

Inscription "Mrs Susannah/Wright/Died 26<sup>th</sup> April/1819/Aged 65 years" (618 in nec as inner border & 845 outer as outer border.)

Fabric lead  ormolou  brass  tin plated pewter  gilt tin   
 iron  silvered tin  enamelled  other ..... Sample Ret.   
*black polished.*

**Shape of dep. plate**

square  rectangle  shield  tapered  lozenge   
 cartouche  oval  other .....

**Upholstery**

colour ..... shoddy  velvet  other ..... Sample Ret.

**Construction**

butt joint  mitred  pitched  other .....

Grip plate  Fabric = ormolou  brass  tin plated pewter  gilt tin   
 iron  silvered tin  enamelled  other ..... Sample Ret.

Grip  Fabric = ormolou  brass  iron  Sample Ret.

Design swag of rose  horseshoe  cherub's head  plain   
 other .....

Grip bolts  Corner bolts  Type = gilt brass  brass  iron

other ..... Sample Ret.

Lid motifs  other ..... Sample Ret.

Escutcheons  other ..... Sample Ret.

Upholstery nails  brass  gilt brass  silvered brass  iron  enamelled   
 other ..... Sample Ret.

Fixings  panel nails  screws  hinges  lace  Sample Ret.

Timber type ..... Sample Ret.

**Interpretation / Comments**

.....  
 .....



|                           |                                                            |                             |
|---------------------------|------------------------------------------------------------|-----------------------------|
| SITE<br>02100.            | COFFIN RECORD SHEET                                        | CONTEXT NO.<br>1136         |
| Trench:                   | Additional sheets:                                         | Treatment:<br>Rocks.        |
| Site sub-div:<br>cut 6412 | Grave fills:                                               |                             |
| Plan no:<br>7.            | Grave cut:                                                 | Finds<br>None ✓             |
| Section no:               | Skeleton:                                                  | Breastplate<br>Grip         |
| Co-ordinates:             | Matrix location:<br>—                                      | Hinge<br>Bracket            |
| Levels:                   | Preservation:<br>v. poor - Corroded<br>ALONG SIDES + BASE. | Fixing nails<br>Shroud pins |
| Slide No.:                | Neg No:                                                    | Fabric<br>Other finds:      |

Description ADULT Males COFFIN  
NORTH-SOUTH ALIGNED.  
UNNAMED.

Discussion  
FRAGMENTED.

Shape, dimensions and distinguishing characteristics

LID

HEAD

BASE

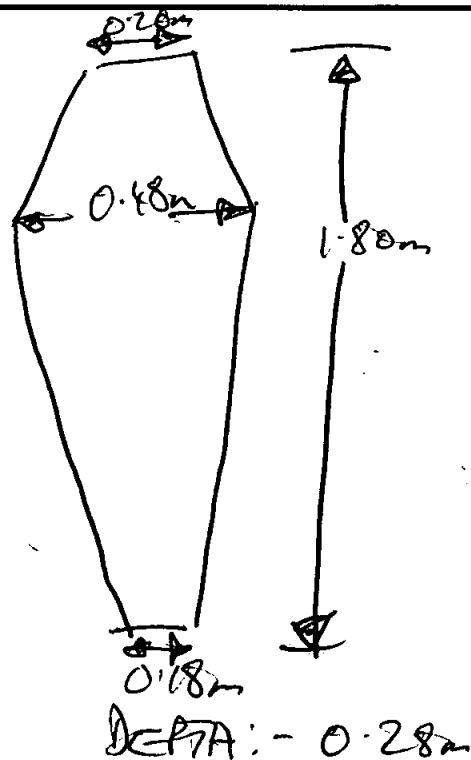

|                |                   |           |
|----------------|-------------------|-----------|
| Recorder:<br>M | Date:<br>4.12.00. | Initials: |
|----------------|-------------------|-----------|

|                                   |                                                    |                                                   |
|-----------------------------------|----------------------------------------------------|---------------------------------------------------|
| SITE<br><i>OLR00</i>              | COFFIN RECORD SHEET                                | CONTEXT NO. <i>1137</i>                           |
| Trench:                           | Additional sheets:                                 | Treatment:<br><i>BONES</i>                        |
| Site sub-div:<br><i>CURT SANZ</i> | Grave fills:                                       |                                                   |
| Plan no:<br><i>7</i>              | Grave cut:                                         | Finds<br>None <input checked="" type="checkbox"/> |
| Section no:                       | Skeleton:                                          | Breastplate<br>Grip                               |
| Co-ordinates:                     | Matrix location:<br><i>0/2 1139</i>                | Hinge<br>Bracket                                  |
| Levels:                           | Preservation:<br><i>CORRODED AT SIDES + BOTTOM</i> | Fixing nails<br>Shroud pins                       |
| Slide No.:                        | Neg No.:                                           | Fabric<br>Other finds                             |

Description *ADULT PB COFFIN WITH NORTH ORIENTATED*

Discussion

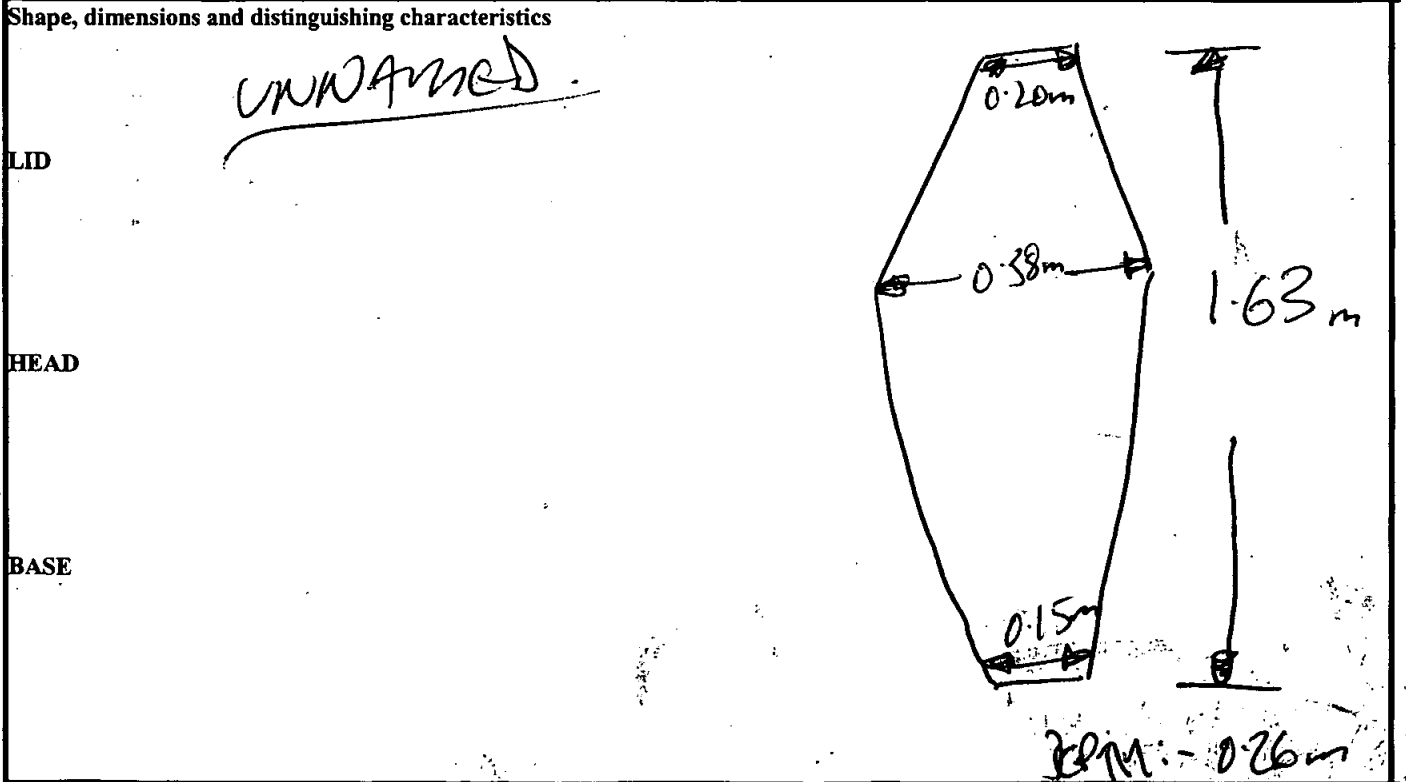

|                     |                      |           |
|---------------------|----------------------|-----------|
| Recorder: <i>PS</i> | Date: <i>4.12.00</i> | Initials: |
|---------------------|----------------------|-----------|

|                                  |                                          |                                                   |
|----------------------------------|------------------------------------------|---------------------------------------------------|
| SITE<br><i>ALROO</i>             | COFFIN RECORD SHEET                      | CONTEXT NO.<br><i>1138</i>                        |
| Trench:                          | Additional sheets:                       | Treatment:<br><i>Bones</i>                        |
| Site sub-div:<br><i>CAMP 547</i> | Grave fills:                             | <del>XXXXXXXXXXXX</del>                           |
| Plan no:<br><i>7</i>             | Grave cut:                               | Finds<br>None <input checked="" type="checkbox"/> |
| Section no:                      | Skeleton:                                | Breastplate<br>Grip                               |
| Co-ordinates:                    | Matrix location:<br><i>adj. to 1137.</i> | Hinge<br>Bracket                                  |
| Levels:                          | Preservation:                            | Fixing nails<br>Shroud pins                       |
| Slide No.                        | Neg No:                                  | Fabric<br>Other finds                             |

Description  
*ADULT FB COFFIN  
SOUTH-NORTH ORIENTED.*

Discussion  
*UNNAMED.*

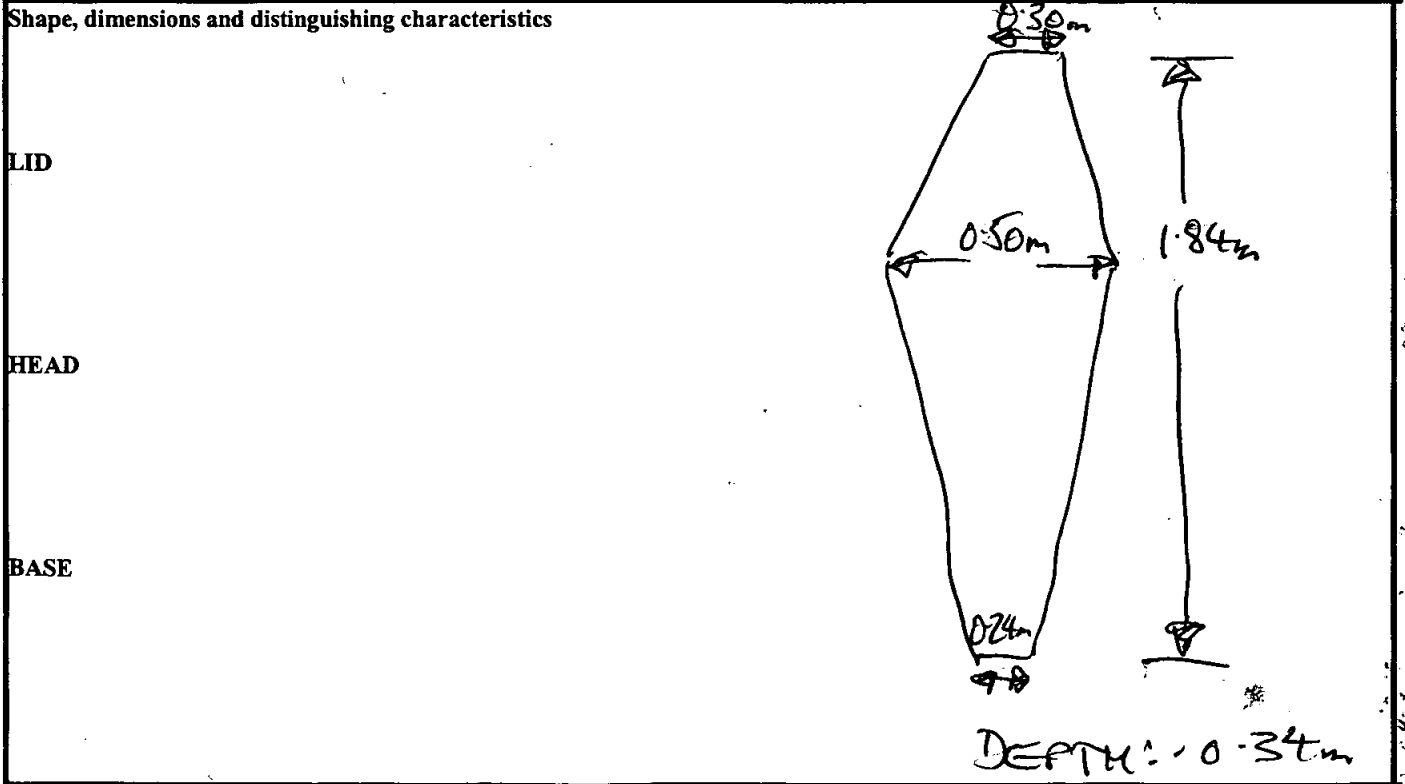

|                        |                         |           |
|------------------------|-------------------------|-----------|
| Recorder:<br><i>Dm</i> | Date:<br><i>4.12.80</i> | Initials: |
|------------------------|-------------------------|-----------|

| SITE          |                                 | COFFIN RECORD SHEET |  | CONTEXT NO. |  |
|---------------|---------------------------------|---------------------|--|-------------|--|
| 02200         |                                 |                     |  | 1139        |  |
| Trench:       | Additional sheets:              | Treatment:          |  |             |  |
| Site sub-div: | Grave fills                     | BONES               |  |             |  |
| Plan no:      | Grave cut:                      | Finds               |  |             |  |
| 7             |                                 | None ✓              |  |             |  |
| Section no:   | Skeleton:                       | Breastplate         |  |             |  |
|               |                                 | Grip                |  |             |  |
| Co-ordinates: | Matrix location:                | Hinge               |  |             |  |
|               |                                 | Bracket             |  |             |  |
| Levels        | Preservation:                   | Fixing nails        |  |             |  |
|               | V. POOR<br>- CORRODED ALL OVER. | Shroud pins         |  |             |  |
| Slide No.     | Neg No:                         | Fabric              |  |             |  |
|               |                                 | Other finds         |  |             |  |

**Description** ADULT Males coffin  
NORTH-SOUTH ORIENTATED.

**Discussion**

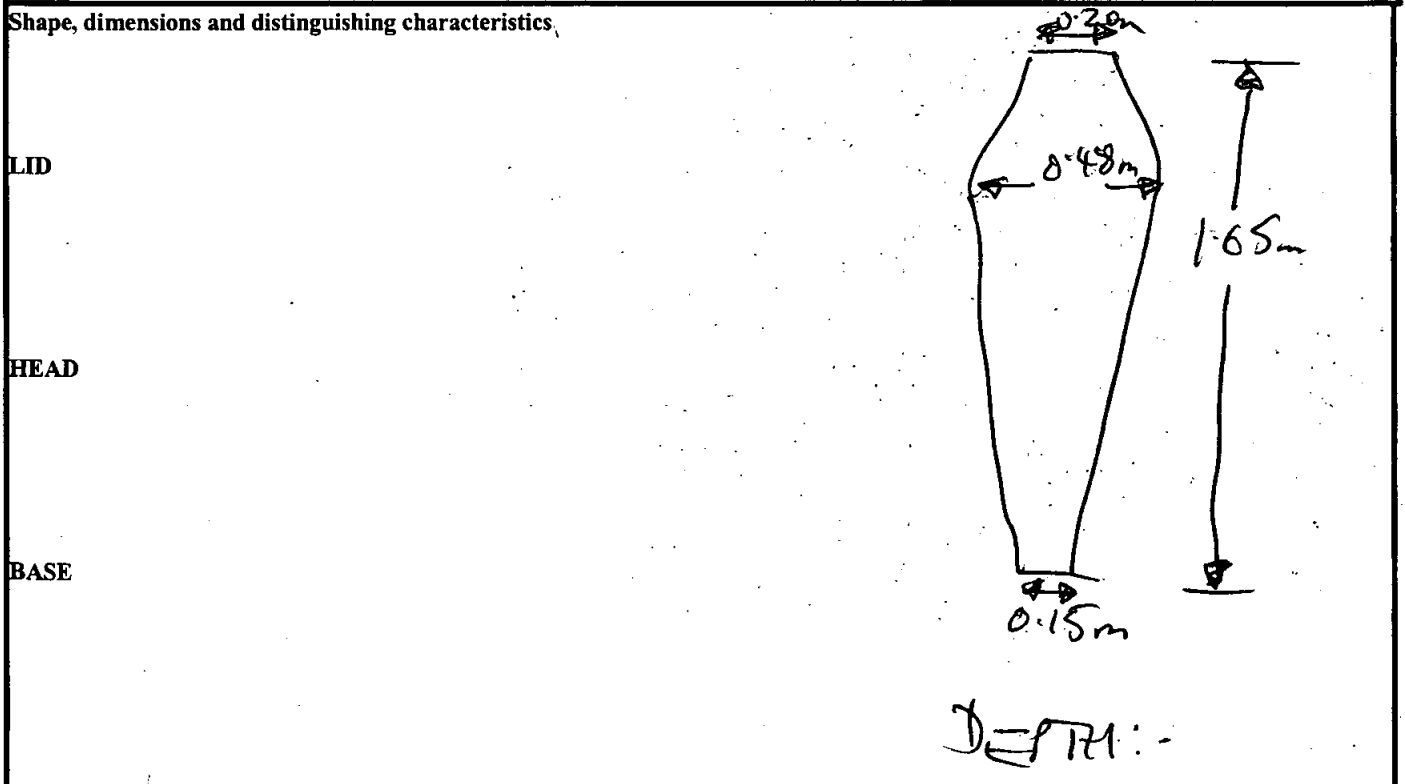

|              |               |           |
|--------------|---------------|-----------|
| Recorder: Dm | Date: 4.12.00 | Initials: |
|--------------|---------------|-----------|

|                          |                                   |                             |
|--------------------------|-----------------------------------|-----------------------------|
| SITE<br>1140             | COFFIN RECORD SHEET               | CONTEXT NO.<br>1140         |
| Trench:                  | Additional sheets:                | Treatment:                  |
| Site sub-div:<br>CMT BAR | Grave fills:                      | INTAG - NECRDP.             |
| Plan no:<br>7            | Grave cut:                        | Finds<br>None ✓             |
| Section no:              | Skeleton:                         | Breastplate<br>Grip         |
| Co-ordinates:            | Matrix location:<br>Adj. to 1135. | Hinge<br>Bracket            |
| Levels:                  | Preservation:<br>GOOD.            | Fixing nails<br>Shroud pins |
| Slide No.:               | Neg No.:                          | Fabric<br>Other finds       |

Description: Adult Pb Coffin  
East-West orientated.

Discussion:

Shape, dimensions and distinguishing characteristics

INSCRIPTION:

LID

MRS

Eliza Judley  
Died 18<sup>th</sup> March

HEAD

1835

BASE

In her 28<sup>th</sup> Year

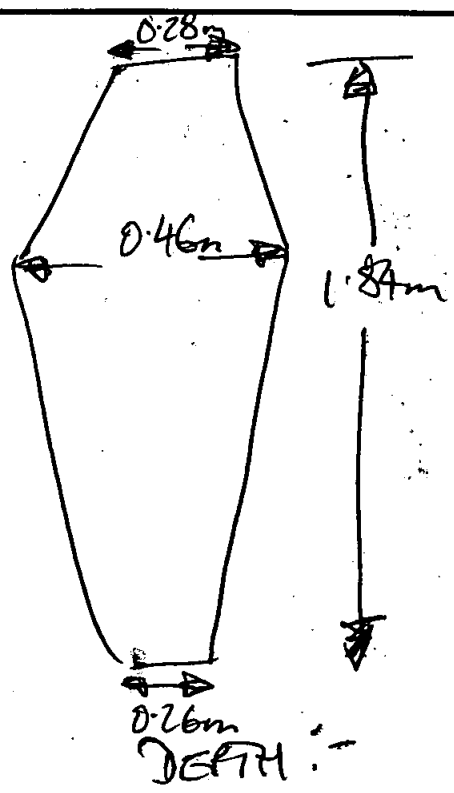

|          |               |           |
|----------|---------------|-----------|
| Order: M | Date: 4.12.00 | Initials: |
|----------|---------------|-----------|

|                     |                                 |                                      |
|---------------------|---------------------------------|--------------------------------------|
| SITE: OLROO         | COFFIN RECORD SHEET             | CONTEXT NO. 1141                     |
| Trench:             | Additional sheets:              | Treatment: BONES LIFTED<br>DNA TAKEN |
| Site sub-div: CRYPT | Grave fills                     |                                      |
| Plan no: 7          | Grave cut:                      | Finds<br>None<br>mscrip. (2)         |
| Section no:         | Skeleton:                       | Breastplate<br>Grip B (6)            |
| Co-ordinates:       | Matrix location: Bay A w/L 1089 | Hinge<br>Bracket studs (Fe)          |
| Levels              | Preservation: 1                 | Fixing nails<br>Shroud pins          |
| Slide No.           | Neg No:                         | Fabric<br>Other finds                |

Description: adult pb coffin, E → W, Brass bottom end.

Discussion:

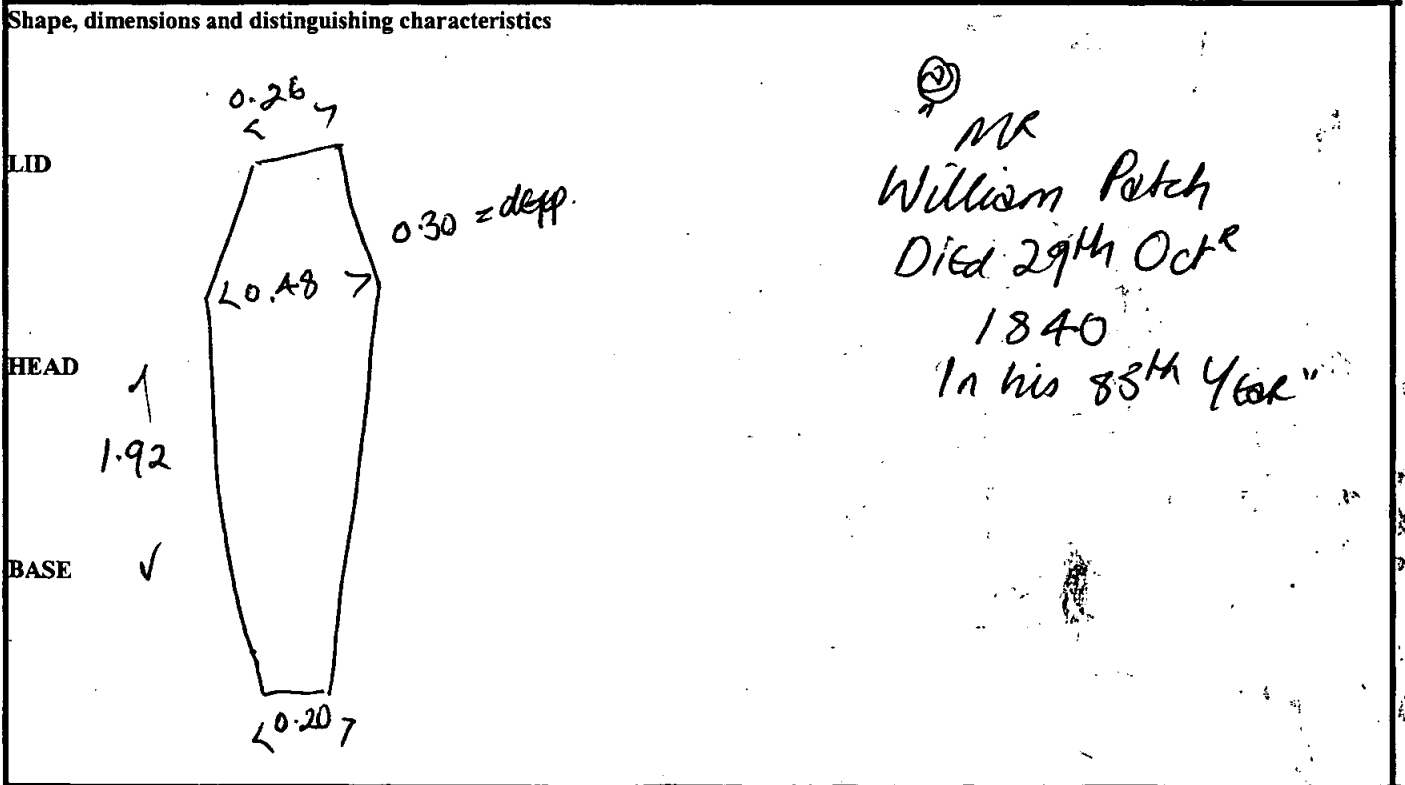

Recorder: AHWCO Date: Mel Initials:

| SITE                 | COFFIN RECORD SHEET                  | CONTEXT NO.                                    |
|----------------------|--------------------------------------|------------------------------------------------|
| OLR00                |                                      | 1142                                           |
| Trench:              | Additional sheets: YES X1.           | Treatment: DNA TAKEN<br>BONES LIFTED.          |
| Site sub-div: CRYPT. | Grave fills                          |                                                |
| Plan no: 7           | Grave cut:                           | Finds<br>None                                  |
| Section no:          | Skeleton:                            | Breastplate ✓ bp.<br>inscrip (2)<br>Grip       |
| Co-ordinates:        | Matrix location: in Bay 4. c/c 1129. | Hinge<br>Bracket<br>shuds (fe)<br>Fixing nails |
| Levels               | Preservation: 1                      | Shroud pins                                    |
| Slide No.            | Neg No:                              | Fabric<br>Other finds                          |

Description: adult p.b. coffin. N → E.

Discussion:

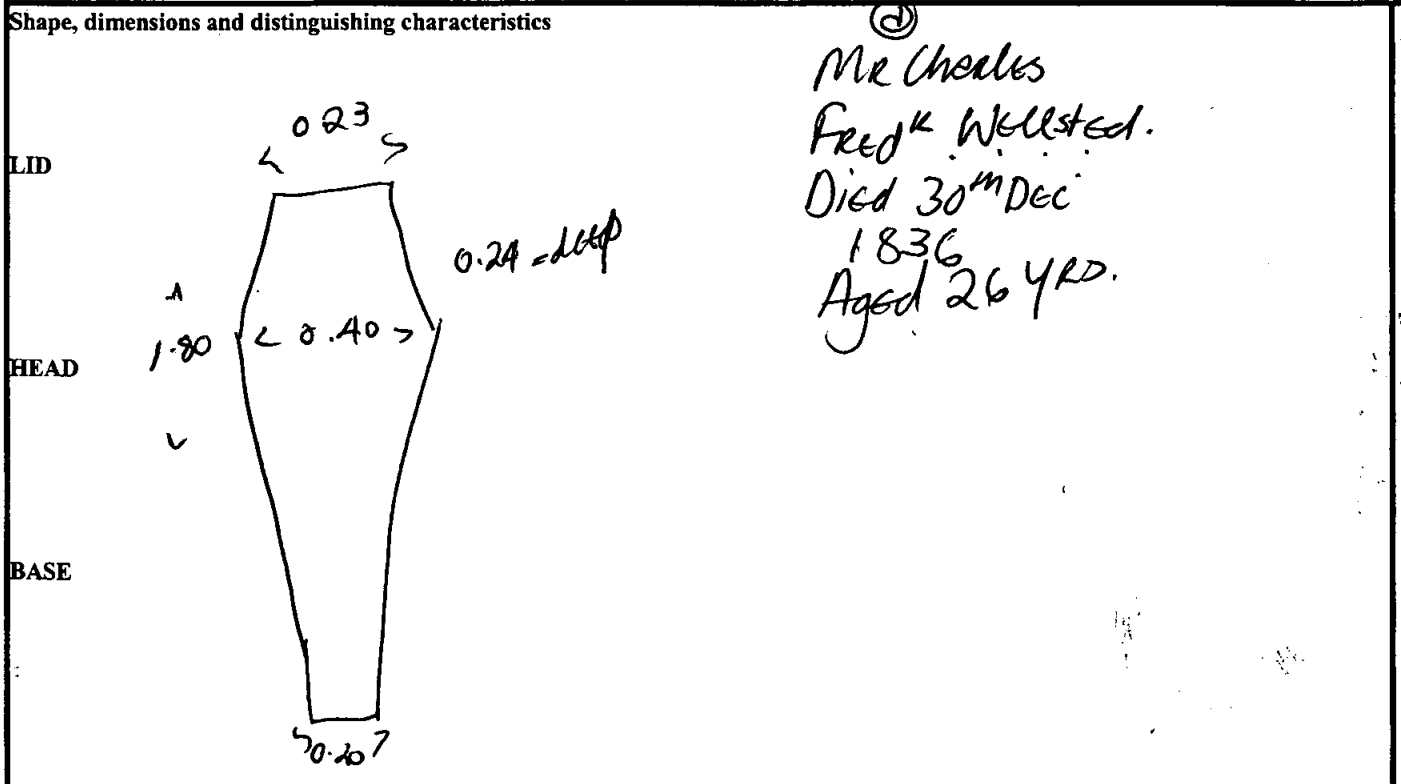

|                   |            |           |
|-------------------|------------|-----------|
| Recorder: 4/12/00 | Date: Mel. | Initials: |
|-------------------|------------|-----------|



# Coffin Recording Sheet

Site Code

Context

OK200

1142

Outer Coffin

Sample Ret.

Recording Date ..... 13/12/00

Associated Numbers .....

Condition ..... 2

Dep. Plate

Legible

Inscription "Mr Choates/Fred<sup>k</sup> Wellsted/Died 30<sup>th</sup> Dec/1836/Aged 26 Yrs"  
Some on 776 w/ 534 outer border.

Fabric lead  ormolou  brass  tin plated pewter  gilt tin   
iron  silvered tin  enamelled  other ..... Sample Ret.

Shape of dep. plate

square  rectangle  shield  tapered  lozenge   
cartouche  oval  other .....

Upholstery

colour ..... shoddy  velvet  other ..... Sample Ret.

Construction

butt joint  mitred  pitched  other .....

Grip plate  Fabric = ormolou  brass  tin plated pewter  gilt tin   
iron  silvered tin  enamelled  other ..... Sample Ret.

Grip  Fabric = ormolou  brass  iron  Sample Ret.

Design swag of rose  horseshoe  cherub's head  plain   
other .....

Grip bolts  Corner bolts  Type = gilt brass  brass  iron   
other ..... Sample Ret.

Lid motifs  other ..... Sample Ret.

Escutcheons  other ..... Sample Ret.

Upholstery nails  brass  gilt brass  silvered brass  iron  enamelled   
other ..... Sample Ret.

Fixings  panel nails  screws  hinges  lace  Sample Ret.

Timber type ..... Sample Ret.

Interpretation / Comments

.....  
.....



|                                |                                                          |                                                                                                        |
|--------------------------------|----------------------------------------------------------|--------------------------------------------------------------------------------------------------------|
| SITE: <b>6LR00</b>             | COFFIN RECORD SHEET                                      | CONTEXT NO. <b>1143</b>                                                                                |
| Trench:                        | Additional sheets: <b>YES x1.</b>                        | Treatment: <b>INTACT</b> →                                                                             |
| Site sub-div: <b>SC.V.1160</b> | Grave fills                                              | <b>NECROP</b>                                                                                          |
| Plan no: <b>6</b>              | Grave cut:                                               | Finds                                                                                                  |
| Section no:                    | Skeleton:                                                | None<br>inscrip top pb ② + bored.<br>Breastplate ✓ top pb ②<br>Grip ④ + grip fe plate ③<br>black black |
| Co-ordinates:                  | Matrix location: <b>in vault 1160</b><br><b>o/c 1147</b> | Hinge                                                                                                  |
| Levels                         | Preservation: <b>A</b>                                   | Bracket                                                                                                |
| Slide No.                      | Neg No:                                                  | Fixing nails                                                                                           |
|                                |                                                          | Shroud pins <b>DOZE</b>                                                                                |
|                                |                                                          | Fabric                                                                                                 |
|                                |                                                          | Other finds                                                                                            |

Description **adult pb coffin, fe → W**  
**lid is bevelled**

v. similar assemblage to 340; ie. flower pot furniture angels.



Shape, dimensions and distinguishing characteristics

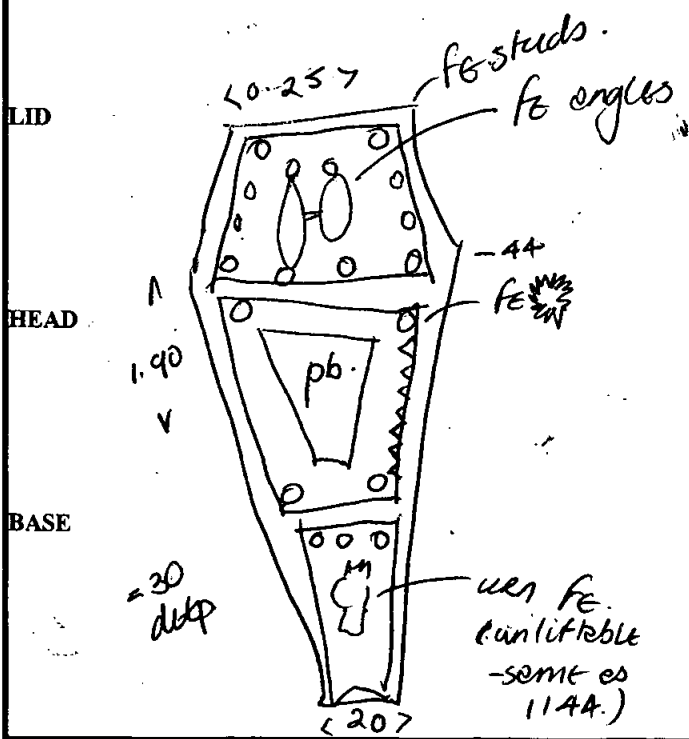

② "Miss Mary Ellis  
Died 20<sup>th</sup> Sept.  
1838  
Aged 48 yrs"

③ Miss Mary Ellis  
Died 20 Sept  
1838  
Aged 48 yrs

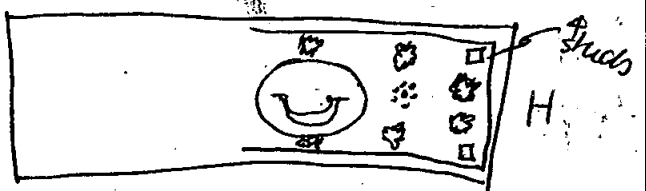

|                      |                   |           |
|----------------------|-------------------|-----------|
| Recorder: <b>Mel</b> | Date: <b>5/12</b> | Initials: |
|----------------------|-------------------|-----------|

**Outer Coffin**

Sample Ret.

Site Code

Context

Recording Date ..... 13/12/00 .....

0200

1143

Associated Numbers .....

Condition ..... 3 .....

Dep. Plate

Legible

Inscription "Miss/Mary Ellis/Died 2 Sept/1838/Aged 48 Yrs"

*same as 776. w/ 534 outer border.*

Fabric lead  ormolou  brass  tin plated pewter  gilt tin   
iron  silvered tin  enamelled  other ..... Sample Ret.

*black polished.*

Shape of dep. plate

square  rectangle  shield  tapered  lozenge   
cartouche  oval  other .....

Upholstery

colour ..... shoddy  velvet  other ..... Sample Ret.

Construction butt joint  mitred  pitched  other .....

Grip plate  Fabric = ormolou  brass  tin plated pewter  gilt tin   
iron  *black (3)* silvered tin  enamelled  other ..... Sample Ret.

Grip  Fabric = ormolou  brass  iron  *black (A)* Sample Ret.   
Design swag of rose  horseshoe  cherub's head  plain

other .....

Grip bolts  Corner bolts  Type = gilt brass  brass  iron

other ..... Sample Ret.

Lid motifs  other 1x Fe (6) & 1x Fe urn same as 1144 ..... Sample Ret.

Escutcheons  other many - Fe (6)'s black enamelled ..... Sample Ret.

Upholstery <sup>sheds</sup> ~~nails~~  brass  gilt brass  silvered brass  iron  enamelled

other ..... many: new design, see field sheet ..... Sample Ret.

Fixings  panel nails  screws  hinges  lace  Sample Ret.

Timber type ..... Sample Ret.

Interpretation / Comments

.....  
.....

| SITE                     | COFFIN RECORD SHEET                 | CONTEXT NO.                                                                                                    |
|--------------------------|-------------------------------------|----------------------------------------------------------------------------------------------------------------|
| 02100                    |                                     | 1144                                                                                                           |
| Trench:                  | Additional sheets: YES x3           | Treatment: BODY LIFTED<br>DNA TAKEN, NO TOES/FINGERS<br>BECAUSE OF BEAN.                                       |
| Site sub-div: SC v. 1160 | Grave fills                         |                                                                                                                |
| Plan no: 6               | Grave cut:                          | Finds                                                                                                          |
| Section no:              | Skeleton:                           | None<br>inscrip. rect. ②<br>Breastplate <del>pb</del> + plate rect.<br>Grip ④ + ③ pb plate.<br>(inscribed!) x3 |
| Co-ordinates:            | Matrix location: vault 1160 of 1146 | Hinge                                                                                                          |
| Levels                   | Preservation: 2                     | Bracket                                                                                                        |
| Slide No.                | Neg No:                             | Fixing nails                                                                                                   |
|                          |                                     | Shroud pins                                                                                                    |
|                          |                                     | Fabric                                                                                                         |
|                          |                                     | Other finds                                                                                                    |

**Description** 2 adult pb coffin, N → E, Bean in bottom end, gone from west down.

**Discussion**

**Shape, dimensions and distinguishing characteristics**

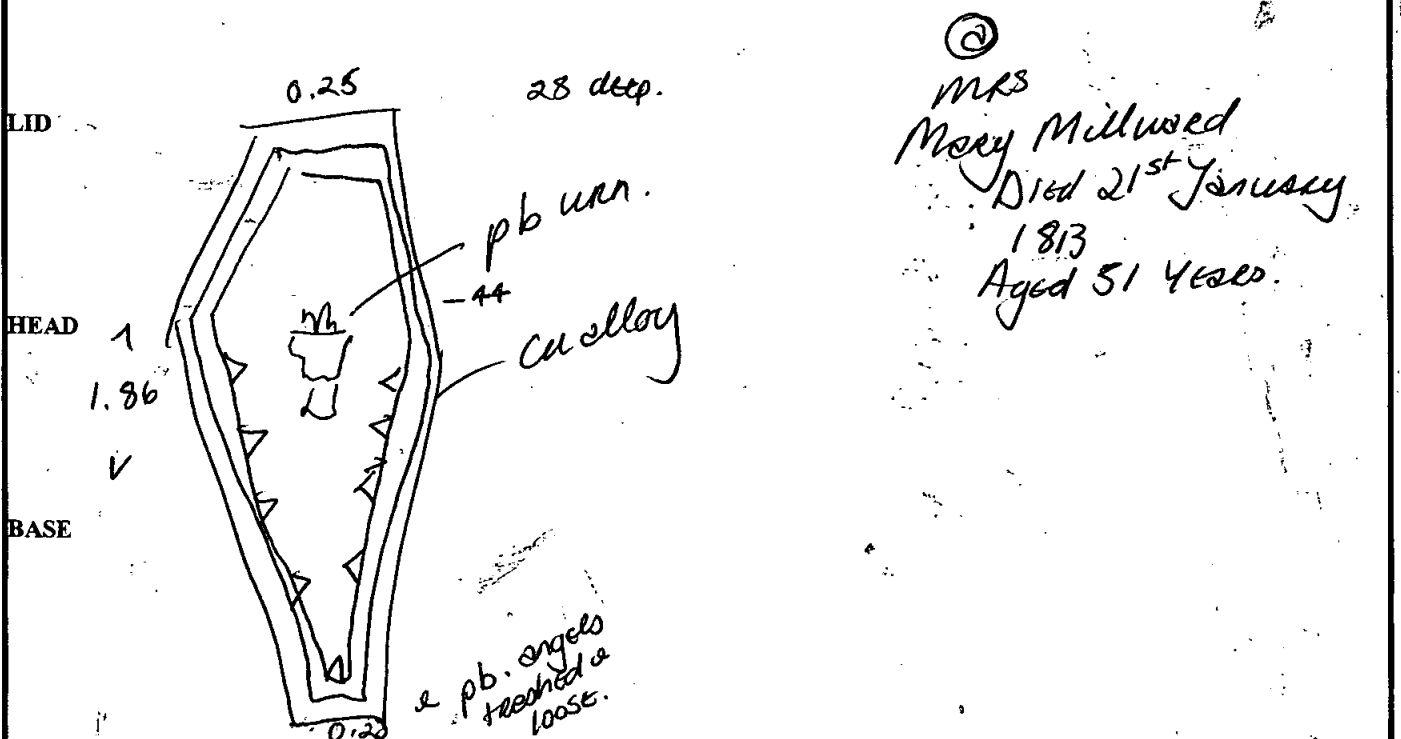

②  
MRS  
Mary Millwood  
Died 21<sup>st</sup> January  
1813  
Aged 51 years.

Recorder: Mel Date: 5/12 Initials:

Site Code

Context

Outer Coffin

Sample Ret.

02R00

1144

Recording Date ..... 13/12/00

Associated Numbers .....

Condition ..... 3

Dep. Plate

Legible

Inscription "Mrs/Mary Millwood/Died 21<sup>st</sup> June/1813/Aged 51 Years"  
Sptfds ⑧ w/ new outer border.

Fabric lead  ormolou  brass  tin plated pewter  gilt tin   
iron  silvered tin  enamelled  other ..... Sample Ret.

Shape of dep. plate

square  rectangle  shield  tapered  lozenge   
cartouche  oval  other .....

Upholstery

colour ..... shoddy  velvet  other ..... Sample Ret.

Construction butt joint  mitred  pitched  other .....

Grip plate  Fabric = ormolou  brass  tin plated pewter  gilt tin   
iron  silvered tin  enamelled  other p. 13 inscribed x2  
+ (plain x 2) see sheet. Sample Ret.

Grip  Fabric = ormolou  brass  iron  x 3 Sample Ret.

Design swag of rose  horseshoe  cherub's head  ④'s. plain   
other .....

Grip bolts  Corner bolts  Type = gilt brass  brass  iron   
other ..... Sample Ret.

Lid motifs  other 1x pb Honing urn - new see sheet. Sample Ret.

Escutcheons  other ..... Sample Ret.

Upholstery nails  brass  gilt brass  silvered brass  iron  enamelled   
other ..... Sample Ret.

Fixings  panel nails  screws  hinges  lace  Sample Ret.

Timber type ..... Sample Ret.

Interpretation / Comments

~~1x pb Honing urn - new see sheet.~~



↑  
0.18  
↓

scale 1:1.

← 0.26 →

| SITE                                                  |  | COFFIN RECORD SHEET                           |  | CONTEXT NO.                                   |  |
|-------------------------------------------------------|--|-----------------------------------------------|--|-----------------------------------------------|--|
| 02100                                                 |  | Additional sheets: YES x1                     |  | 1145                                          |  |
| Trench:                                               |  | Grave fills:                                  |  | Treatment: BONES LIFTED<br>DNA TAKEN          |  |
| Site sub-div: SC V.1160                               |  | Grave cut:                                    |  | DIN                                           |  |
| Plan no: 6                                            |  | Skeleton:                                     |  | Finds                                         |  |
| Section no:                                           |  | Matrix location: in vault 1160<br>adj to 1146 |  | None                                          |  |
| Co-ordinates:                                         |  | Preservation: 2                               |  | Breastplate / ect. (2)<br>INSCRIP (2)<br>Grip |  |
| Levels:                                               |  | Slide No:                                     |  | Hinge                                         |  |
| Slide No:                                             |  | Neg No:                                       |  | Bracket                                       |  |
| Description: adult pb coffin E-SW on N side, squashed |  | Discussion: no dimensions possible            |  | Fixing nails                                  |  |
| Shape, dimensions and distinguishing characteristics  |  | LID                                           |  | Shroud pins                                   |  |
| HEAD                                                  |  | BASE                                          |  | Fabric                                        |  |
| Recorder: MJD                                         |  | Date: 5.12.00                                 |  | Other finds:                                  |  |

Too muddled

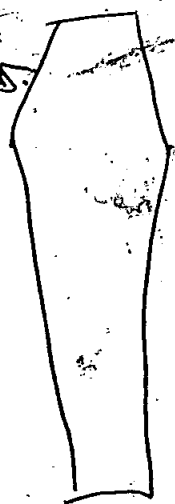

(2)  
"Mrs Lou  
Mary Lou  
Died 21st Nov  
1802  
Aged 55 years"

(6)  
Mrs Lou  
Mary Lou

Site Code

Context

**Outer Coffin**

Sample Ret.

OK200

1145

Recording Date ..... 13/12/00 .....

Associated Numbers .....

Condition ..... 3 .....

Dep. Plate

Legible

Inscription "Mrs/Mary <sup>kan</sup> ~~had~~ / Died 21<sup>st</sup> Nov/1802/Aged 75 Years"  
Spttds (6) w/ 621 outer border.

Fabric lead  ormolou  brass  tin plated pewter  gilt tin   
iron  silvered tin  enamelled  other ..... Sample Ret.

**Shape of dep. plate**

square  rectangle  shield  tapered  lozenge   
cartouche  oval  other .....

**Upholstery**

colour ..... shoddy  velvet  other ..... Sample Ret.

**Construction** butt joint  mitred  pitched  other .....

**Grip plate**  Fabric = ormolou  brass  tin plated pewter  gilt tin   
iron  silvered tin  enamelled  other ..... Sample Ret.

**Grip**  Fabric = ormolou  brass  iron  Sample Ret.

**Design** swag of rose  horseshoe  cherub's head  plain   
other .....

**Grip bolts**  **Corner bolts**  Type = gilt brass  brass  iron   
other ..... Sample Ret.

**Lid motifs**  other ..... Sample Ret.

**Escutcheons**  other ..... Sample Ret.

**Upholstery nails**  brass  gilt brass  silvered brass  iron  enamelled   
other ..... Sample Ret.

**Fixings**  panel nails  screws  hinges  lace  Sample Ret.

**Timber type** ..... Sample Ret.

**Interpretation / Comments**

.....  
.....

| SITE <i>OLR00</i>             |                                                | COFFIN RECORD SHEET                                                                          | CONTEXT NO. <i>1146</i> |
|-------------------------------|------------------------------------------------|----------------------------------------------------------------------------------------------|-------------------------|
| Trench:                       | Additional sheets: <i>YES x1</i>               | Treatment: <i>DNA TAKEN</i>                                                                  |                         |
| Site sub-div: <i>SCV.1160</i> | Grave fills                                    | <i>BONES LIFTED.</i>                                                                         |                         |
| Plan no: <i>B</i>             | Grave cut:                                     | Finds                                                                                        |                         |
| Section no:                   | Skeleton:                                      | None                                                                                         |                         |
| Co-ordinates:                 | Matrix location: <i>w/ 114A, in vault 1160</i> | Breastplate <input checked="" type="checkbox"/> <i>rect pb. ②</i><br><i>inscript ⑤ rect.</i> |                         |
| Levels                        | Preservation: <i>1</i>                         | Hinge                                                                                        |                         |
| Slide No.                     | Neg No:                                        | Bracket                                                                                      |                         |
|                               |                                                | Fixing nails                                                                                 |                         |
|                               |                                                | Shroud pins                                                                                  |                         |
|                               |                                                | Fabric                                                                                       |                         |
|                               |                                                | Other finds                                                                                  |                         |

Description *p.b. adult. on its side, badly squashed*  
*no, dimensions possible. E → W.*

Discussion

Shape, dimensions and distinguishing characteristics

LID

HEAD

BASE

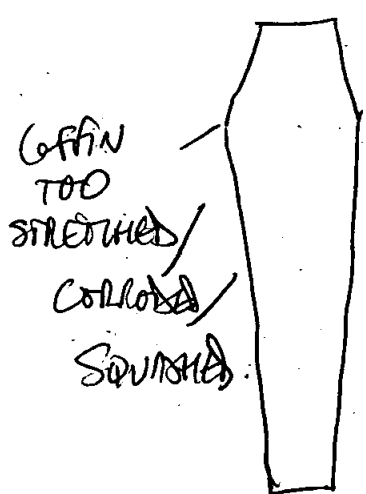

*MR ① Len*  
*Thomas Len?*  
*Died 12<sup>th</sup> Oct*  
*1806?*  
*In his 42<sup>nd</sup> year*

*② Len*  
*MR Thomas Len?*  
*Died 12 Oct*  
*1806*  
*In his 42<sup>nd</sup> year.*

|                         |                      |           |
|-------------------------|----------------------|-----------|
| Recorder: <i>Dm/Med</i> | Date: <i>5.17.00</i> | Initials: |
|-------------------------|----------------------|-----------|



# Coffin Recording Sheet

**Outer Coffin**

Sample Ret.

Site Code

Context

*Orloo*

*1146*

Recording Date .....

Associated Numbers .....

Condition *1* .....

Dep. Plate

Legible

Inscription *"Mr Thomas hen/Died 12<sup>th</sup> Oct/1806/In his 42<sup>nd</sup> Year"  
Spflds (6) w/out outer border.*

Fabric lead  ormolou  brass  tin plated pewter  gilt tin   
iron  silvered tin  enamelled  other ..... Sample Ret.

*traces of gilding.*

**Shape of dep. plate**

square  rectangle  shield  tapered  lozenge   
cartouche  oval  other .....

**Upholstery**

colour ..... shoddy  velvet  other ..... Sample Ret.

**Construction**

butt joint  mitred  pitched  other .....

Grip plate  Fabric = ormolou  brass  tin plated pewter  gilt tin   
iron  silvered tin  enamelled  other ..... Sample Ret.

Grip  Fabric = ormolou  brass  iron  Sample Ret.

Design swag of rose  horseshoe  cherub's head  plain   
other .....

Grip bolts  Corner bolts  Type = gilt brass  brass  iron

other ..... Sample Ret.

Lid motifs  other ..... Sample Ret.

Escutcheons  other ..... Sample Ret.

Upholstery nails  brass  gilt brass  silvered brass  iron  enamelled   
other ..... Sample Ret.

Fixings  panel nails  screws  hinges  lace  Sample Ret.

Timber type ..... Sample Ret.

**Interpretation / Comments**

.....  
.....

| SITE             | COFFIN RECORD SHEET                          | CONTEXT NO.                                             |
|------------------|----------------------------------------------|---------------------------------------------------------|
| 02R00            |                                              | 1147                                                    |
| Trench:          | Additional sheets: WES XI.                   | Treatment: BONES LIFTED.<br>DNA TAKEN.                  |
| Site sub-div: SL | Grave fills                                  |                                                         |
| Plan no: B       | Grave cut:                                   | Finds                                                   |
| Section no:      | Skeleton:                                    | None<br>Inscript ②<br>Breastplate 1/2 ①'s<br>Grip xiv ② |
| Co-ordinates:    | Matrix location: u/l. 1143. in<br>vault 1160 | Hinge                                                   |
| Levels           | Preservation: 2                              | Bracket                                                 |
| Slide No.        | Neg No:                                      | Fixing nails                                            |
|                  |                                              | Shroud pins                                             |
|                  |                                              | Fabric                                                  |
|                  |                                              | Other finds                                             |

**Description** adult pb coffin, w/ wallo, studwork, E → W.  
900  
~~900~~ in coffin, bones in BREASTPLATE (SAME AS BELOW)  
**Discussion** poor cond, inner wooden case almost completely gone.

**Shape, dimensions and distinguishing characteristics**

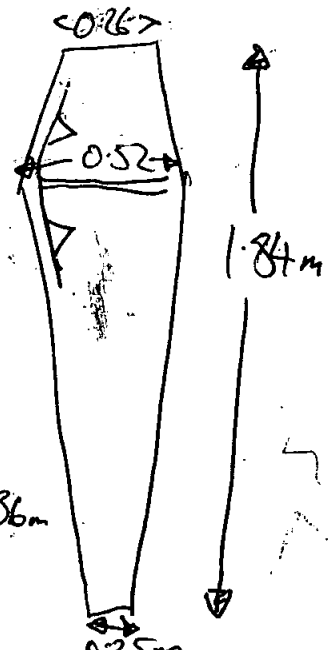

INSRIPTION: -  
(SOLDERED TO PLATE).  
Mr @ rect, plain  
Michael Lau (hon)  
Died 24<sup>th</sup> Mar<sup>h</sup>  
1785  
In his 53<sup>rd</sup> Year.

Recorder: Jm Date: 6.12.00 Initials:

# Coffin Recording Sheet

Site Code

Context

Outer Coffin

Sample Ret.

01200

1147

Recording Date ..... 8/12 .....

Associated Numbers .....

Condition ..... **A** .....

Dep. Plate

Legible

Inscription "Mr Michael Ker/Died 24<sup>th</sup> Mar<sup>y</sup> 1785/In his 53<sup>rd</sup> Year"

Fabric lead  ormolou  brass  tin plated pewter  gilt tin   
iron  silvered tin  enamelled  other ..... Sample Ret.

*Spltds (8) w/ 699 inner & (8) inner @ outer border.*

Shape of dep. plate

square  rectangle  shield  tapered  lozenge   
cartouche  oval  other .....

Upholstery

colour ..... shoddy  velvet  other ..... Sample Ret.

Construction

butt joint  mitred  pitched  other .....

Grip plate  Fabric = ormolou  brass  tin plated pewter  gilt tin   
iron  silvered tin  enamelled  other ..... Sample Ret.

Grip  Fabric = ormolou  brass  iron  Sample Ret.

Design swag of rose  horseshoe  cherub's head  plain   
other .....

Grip bolts  Corner bolts  Type = gilt brass  brass  iron   
other ..... Sample Ret.

Lid motifs  other ..... Sample Ret.

Escutcheons  other ..... Sample Ret.

Upholstery nails  brass  gilt brass  silvered brass  iron  enamelled   
other ..... Sample Ret.

Fixings  panel nails  screws  hinges  lace  Sample Ret.

Timber type ..... Sample Ret.

Interpretation / Comments

.....  
.....

| SITE 0400               |                                | COFFIN RECORD SHEET                            | CONTEXT NO. 1148 |
|-------------------------|--------------------------------|------------------------------------------------|------------------|
| Trench:                 | Additional sheets: YES x 1     | Treatment: BONES LIFTED<br>NO TEETH, DNA TAKEN |                  |
| Site sub-div: SC.V.1160 | Grave fills                    |                                                |                  |
| Plan no: 6              | Grave cut:                     | Finds<br>None                                  |                  |
| Section no:             | Skeleton:                      | Breastplate<br>Grip V x 2 black Fe ⊕           |                  |
| Co-ordinates:           | Matrix location: in vault 1160 | Hinge<br>Bracket                               |                  |
| Levels                  | Preservation: 1                | Fixing nails<br>Shroud pins                    |                  |
| Slide No.               | Neg No:                        | Fabric<br>Other finds                          |                  |

**Description** adult pb coffin, E → W, u/l. 1146, broken in coffin - no head.

**Discussion**

**Shape, dimensions and distinguishing characteristics**

pb INSCRIBED PLATE:-  
M?  
Ann (Lerich?)  
Died 22<sup>nd</sup> July  
1798.  
In the 30<sup>th</sup> year  
of her Life.

Recorder: B/Mel Date: 6.12.00 Initials:

**Outer Coffin**

Sample Ret.

Site Code

Context

Recording Date ..... 6/12

OH100

1148

Associated Numbers .....

Condition .....

*inscript.*  
Dep. Plate

Legible  *with*

Inscription

*Mary Ann ~~Wright~~ / Died 22nd July 1796 / In the 30<sup>th</sup> year  
of her life*

Fabric lead  ormolou  brass  tin plated pewter  gilt tin   
iron  silvered tin  enamelled  other ..... Sample Ret.

**Shape of dep. plate**

square  rectangle  *plain* shield  tapered  lozenge   
cartouche  oval  other .....

**Upholstery**

colour ..... shoddy  velvet  other ..... Sample Ret.

**Construction**

butt joint  mitred  pitched  other .....

**Grip plate**

Fabric = ormolou  brass  tin plated pewter  gilt tin

iron  silvered tin  enamelled  other ..... Sample Ret.

**Grip**

Fabric = ormolou  brass  iron  *2x* Sample Ret.

**Design**

swag of rose  horseshoe  cherub's head  *(A)'s block* plain

other .....

**Grip bolts**

Corner bolts  Type = gilt brass  brass  iron

other ..... Sample Ret.

**Lid motifs**

other ..... Sample Ret.

**Escutcheons**

other ..... Sample Ret.

**Upholstery nails**

brass  gilt brass  silvered brass  iron  enamelled

other ..... Sample Ret.

**Fixings**

panel nails  screws  hinges  lace  Sample Ret.

**Timber type** .....

Sample Ret.

**Interpretation / Comments**

.....  
.....

| SITE          |            | COFFIN RECORD SHEET |                           | CONTEXT NO.   |                                     |
|---------------|------------|---------------------|---------------------------|---------------|-------------------------------------|
| Trench:       | 02/100     | Additional sheets:  |                           | Treatment:    | 1189<br>BONES LIFTED<br>& DNA TAKEN |
| Site sub-div: | SC. ✓ 1160 | Grave fills:        |                           | Finds:        | None                                |
| Plan no:      | Ø          | Grave cut:          |                           | Breastplate:  | mscript ©                           |
| Section no:   |            | Skeleton:           |                           | Grip:         | x 1 Fe ①                            |
| Co-ordinates: |            | Matrix location:    | UL 1145, in<br>REULT 1160 | Hinge:        |                                     |
| Levels:       |            | Preservation:       | 3                         | Bracket:      |                                     |
| Slide No.:    |            | Neg No.:            |                           | Fixing nails: | Fe studs black on top edge of side  |
|               |            |                     |                           | Shroud pins:  | beize uphntskny                     |
|               |            |                     |                           | Fabric:       |                                     |
|               |            |                     |                           | Other finds:  |                                     |

Description: adult pb coffin, bronzed, w/ lining frill visible

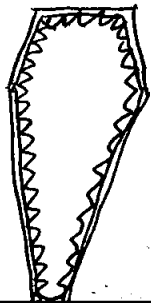

Discussion:

Shape, dimensions and distinguishing characteristics

LID

HEAD

BASE

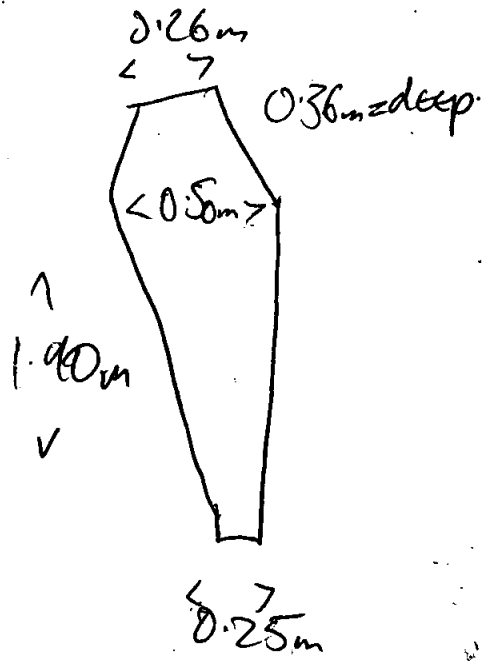

pb INSCRIBED PLATE: -  
© M<sup>r</sup> (rect plain)

Michael ~~son~~ <sup>son</sup> ~~han~~ <sup>han</sup>  
Died 28<sup>th</sup> Sept.

1796  
Aged 89 years

|               |            |           |
|---------------|------------|-----------|
| Recorder: MEL | Date: 5/12 | Initials: |
|---------------|------------|-----------|

|                            |                                           |                                                              |
|----------------------------|-------------------------------------------|--------------------------------------------------------------|
| SITE <b>OLK00</b>          | COFFIN RECORD SHEET                       | CONTEXT NO. <b>1150</b>                                      |
| Trench:                    | Additional sheets:                        | Treatment: <b>BODY COMPLETELY DECOMPOSED - NOTHING THERE</b> |
| Site sub-div: <b>CRYPT</b> | Grave fills                               |                                                              |
| Plan no: <b>7</b>          | Grave cut:                                | Findings<br>None                                             |
| Section no:                | Skeleton:                                 | Breastplate<br>Grip                                          |
| Co-ordinates:              | Matrix location: <b>Bay A, adj to US1</b> | Hinge<br>Bracket                                             |
| Levels                     | Preservation: <b>3/1</b>                  | Fixing nails<br>Shroud pins                                  |
| Slide No.                  | Neg No:                                   | Fabric<br>Other finds                                        |

Description **infant pb. coffin, E-W, some parts oxidised.**

Discussion

Shape, dimensions and distinguishing characteristics

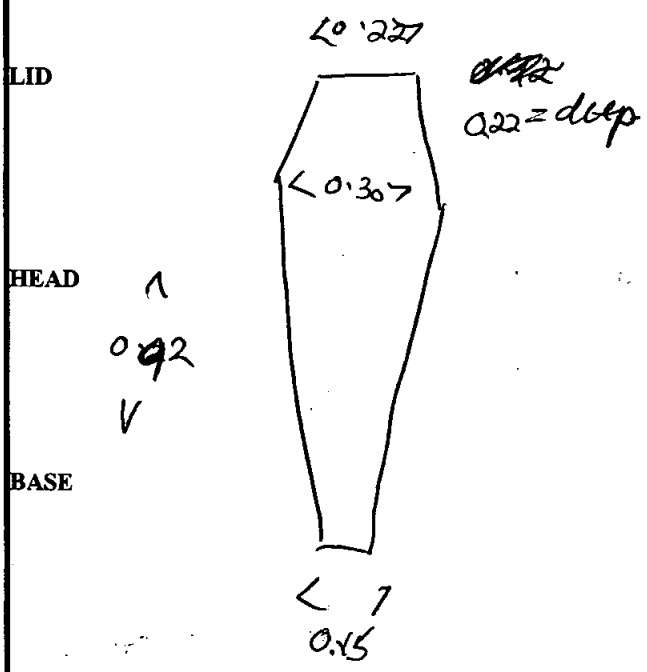

|                      |                   |           |
|----------------------|-------------------|-----------|
| Recorder: <b>Mal</b> | Date: <b>6/12</b> | Initials: |
|----------------------|-------------------|-----------|

| SITE                               | COFFIN RECORD SHEET                | CONTEXT NO.                                        |
|------------------------------------|------------------------------------|----------------------------------------------------|
| 02R00                              |                                    | 1151                                               |
| Trench:                            | Additional sheets:                 | Treatment: BONES LIFTED                            |
| Site sub-div: <del>02R</del> CRYPT | Grave fills:                       |                                                    |
| Plan no: 7                         | Grave cut:                         | Finds<br>None                                      |
| Section no:                        | Skeleton:                          | Breastplate<br>Grip                                |
| Co-ordinates:                      | Matrix location: Box 4 adj to 1150 | Hinge<br>Bracket                                   |
| Levels:                            | Preservation: 2                    | Fixing nails<br>Pb studs & 6 black.<br>Shroud pins |
| Slide No.:                         | Neg No.:                           | Fabric<br>Other finds                              |

**Description** subadult pb coffin, E → W; no name, traces of base on exterior, lining material in coffin w/peaked base design.

**Discussion**

**Shape, dimensions and distinguishing characteristics**

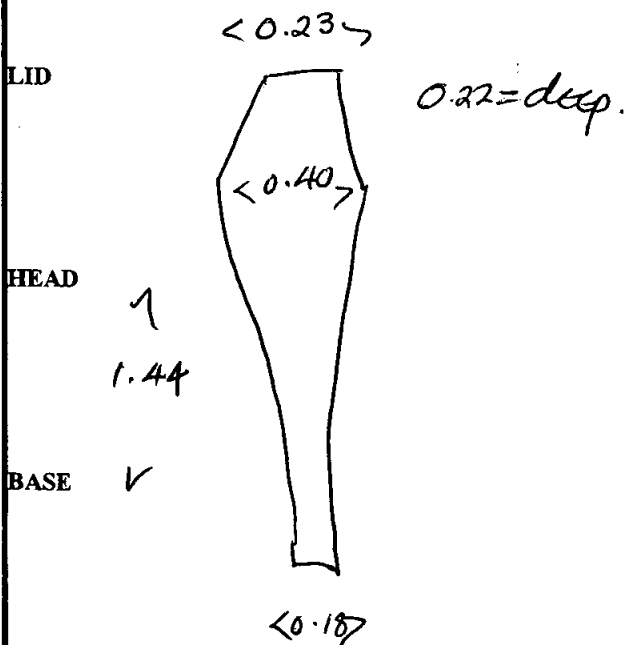

|               |            |           |
|---------------|------------|-----------|
| Recorder: Mel | Date: 6/12 | Initials: |
|---------------|------------|-----------|



| SITE                | COFFIN RECORD SHEET                 | CONTEXT NO.                                     |
|---------------------|-------------------------------------|-------------------------------------------------|
| 07100               |                                     | 1152                                            |
| Trench:             | Additional sheets: 450x2            | Treatment: INTACT<br>⇒ NEEROP                   |
| Site sub-div: CRYPT | Grave fills                         |                                                 |
| Plan no: 7          | Grave cut:                          | Finds<br>None                                   |
| Section no:         | Skeleton:                           | Breastplate, ✓<br>inscript dir & board.<br>Grip |
| Co-ordinates:       | Matrix location: Bay 4. edg to 1153 | Hinge<br>Bracket                                |
| Levels              | Preservation: A                     | Fixing nails<br>Shroud pins                     |
| Slide No.           | Neg No:                             | Fabric<br>Other finds                           |

Description adult pb coffin, E → W.

Discussion

Shape, dimensions and distinguishing characteristics

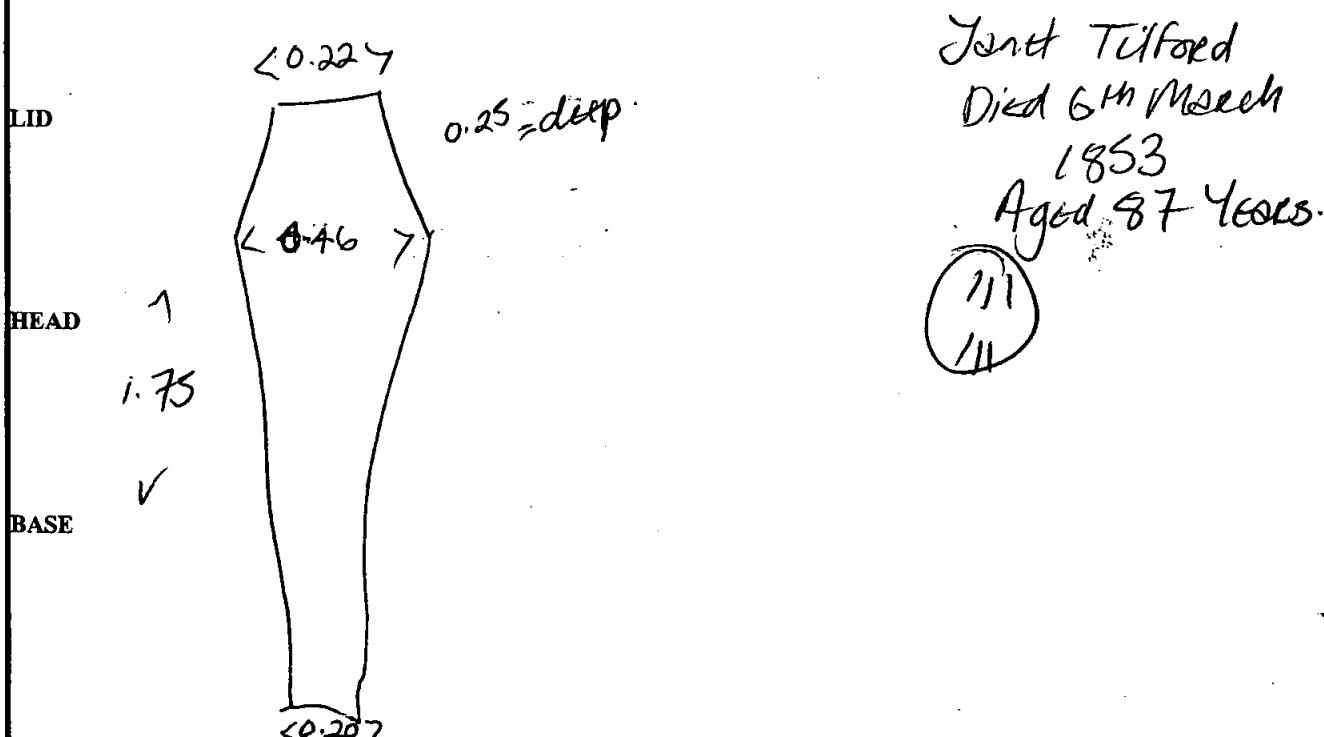

|               |            |           |
|---------------|------------|-----------|
| Recorder: Mel | Date: 6/12 | Initials: |
|---------------|------------|-----------|

**Outer Coffin**

Sample Ret.

Site Code

Context

Recording Date ..... 8/12/00 .....

**OR00**

**1152**

Associated Numbers .....

Condition ..... 3 .....

Dep. Plate

Legible

Inscription "Janet Tilford / Died 6<sup>th</sup> month / 1853 / Aged 87 Yrs" *new type see sheet.*

Fabric lead  ormolou  brass  tin plated pewter  gilt tin   
 iron  silvered tin  enamelled  other ..... Sample Ret.

*black polished.*

**Shape of dep. plate**

square  rectangle  shield  tapered  lozenge   
 cartouche  oval  other .....

**Upholstery**

colour ..... shoddy  velvet  other ..... Sample Ret.

**Construction**

butt joint  mitred  pitched  other .....

**Grip plate**  Fabric = ormolou  brass  tin plated pewter  gilt tin   
 iron  silvered tin  enamelled  other ..... Sample Ret.

**Grip**  Fabric = ormolou  brass  iron  Sample Ret.

**Design** swag of rose  horseshoe  cherub's head  plain   
 other .....

**Grip bolts**  **Corner bolts**  Type = gilt brass  brass  iron

other ..... Sample Ret.

**Lid motifs**  other ..... Sample Ret.

**Escutcheons**  other ..... Sample Ret.

**Upholstery nails**  brass  gilt brass  silvered brass  iron  enamelled

other ..... Sample Ret.

**Fixings**  panel nails  screws  hinges  lace  Sample Ret.

**Timber type** ..... Sample Ret.

**Interpretation / Comments**

.....  
 .....

| SITE                | COFFIN RECORD SHEET                       | CONTEXT NO.                             |
|---------------------|-------------------------------------------|-----------------------------------------|
| OLR00               |                                           | 1153                                    |
| Trench:             | Additional sheets: YES x1                 | Treatment: BONES LIFTED<br>& DNA TAKEN. |
| Site sub-div: CRYPT | Grave fills                               |                                         |
| Plan no: 7          | Grave cut:                                | Finds<br>None                           |
| Section no:         | Skeleton:                                 | Breastplate ✓<br>mscript. dir<br>Grip   |
| Co-ordinates:       | Matrix location: Bay 4 adj to U152 & 115A | Hinge<br>Bracket                        |
| Levels              | Preservation: 2                           | Fixing nails<br>Shroud pins             |
| Slide No.           | Neg No:                                   | Fabric<br>Other finds                   |

Description adult pb coffin, W → NE

Discussion

Shape, dimensions and distinguishing characteristics

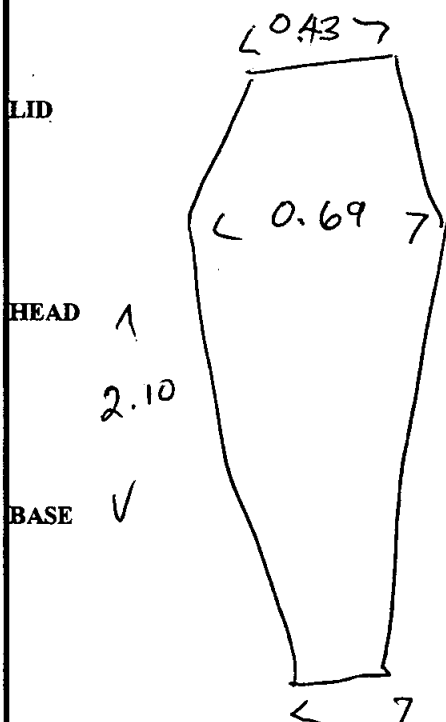

0.37 = deep

William  
Moir Esq.  
Died 2nd August  
1830  
Aged 36.

|               |            |           |
|---------------|------------|-----------|
| Recorder: Mel | Date: 6/12 | Initials: |
|---------------|------------|-----------|

Site Code

Context

**Outer Coffin**

Sample Ret.

02200

1153

Recording Date ..... 12/12/00 .....

Associated Numbers .....

Condition ..... 2 .....

Dep. Plate

Legible

Inscription "William Moore/ Esq & late of new Grange/ Scotland/ Died 2<sup>nd</sup> Aug 1730/ Aged 36 Years"

*same as 162 w/ new border (cutee).*

Fabric lead  ormolou  brass  tin plated pewter  gilt tin   
 iron  silvered tin  enamelled  other ..... Sample Ret.   
*Black polished*

**Shape of dep. plate**

square  rectangle  shield  tapered  lozenge   
 cartouche  oval  other .....

**Upholstery**

colour ..... shoddy  velvet  other ..... Sample Ret.

**Construction**

butt joint  mitred  pitched  other .....

**Grip plate**

Fabric = ormolou  brass  tin plated pewter  gilt tin

iron  silvered tin  enamelled  other ..... Sample Ret.

**Grip**

Fabric = ormolou  brass  iron  Sample Ret.

**Design**

swag of rose  horseshoe  cherub's head  plain

other .....

**Grip bolts**

Corner bolts  Type = gilt brass  brass  iron

other ..... Sample Ret.

**Lid motifs**

other .....

**Escutcheons**

other .....

**Upholstery nails**

brass  gilt brass  silvered brass  iron  enamelled

other ..... Sample Ret.

**Fixings**

panel nails  screws  hinges  lace  Sample Ret.

**Timber type** .....

Sample Ret.

**Interpretation / Comments**

.....  
 .....

| SITE                | COFFIN RECORD SHEET                         | CONTEXT NO.                               |
|---------------------|---------------------------------------------|-------------------------------------------|
| ONR00               |                                             | 1154                                      |
| Trench:             | Additional sheets:                          | Treatment: INTACT<br>⇒ NEOLOP             |
| Site sub-div: CRYPT | Grave fills                                 |                                           |
| Plan no: 7          | Grave cut:                                  | Finds<br>None                             |
| Section no:         | Skeleton:                                   | Breastplate: L-shaped div + bord.<br>Grip |
| Co-ordinates:       | Matrix location: Bay A adj to 1153<br>1155. | Hinge<br>Bracket                          |
| Levels              | Preservation: 4                             | Fixing nails<br>Shroud pins               |
| Slide No.           | Neg No:                                     | Fabric<br>Other finds                     |

Description adult pb coffin, W ⇒ E.

Discussion

Shape, dimensions and distinguishing characteristics

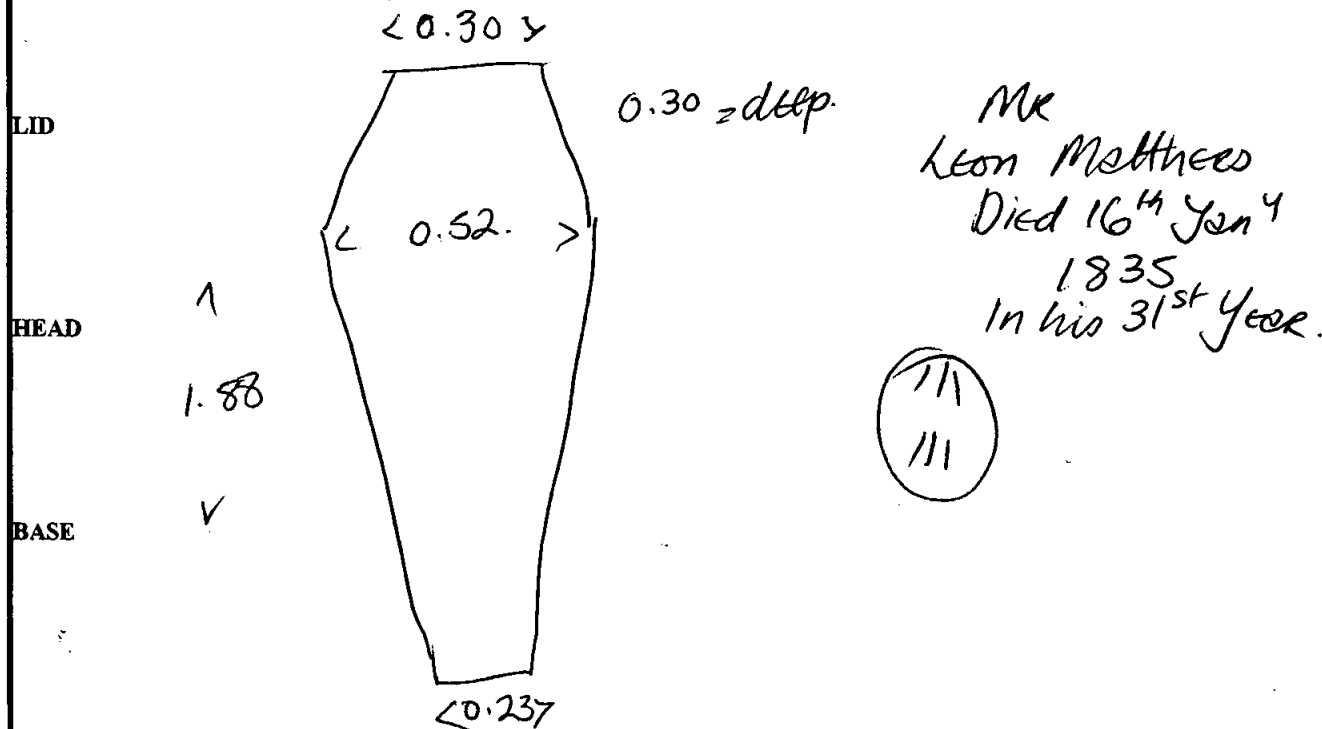

|               |            |           |
|---------------|------------|-----------|
| Recorder: Mel | Date: 6/12 | Initials: |
|---------------|------------|-----------|

| SITE <i>Ohroo</i>          |                                                          | COFFIN RECORD SHEET                         | CONTEXT NO. <i>1155</i> |
|----------------------------|----------------------------------------------------------|---------------------------------------------|-------------------------|
| Trench:                    | Additional sheets:                                       | Treatment: <i>BONES LIFTED</i>              |                         |
| Site sub-div: <i>CRYPT</i> | Grave fills:                                             | DNA TAKEN.                                  |                         |
| Plan no: <i>7</i>          | Grave cut:                                               | Finds                                       |                         |
| Section no:                | Skeleton:                                                | None                                        |                         |
| Co-ordinates:              | Matrix location: <i>in Bay A, adj to 1154 &amp; 1156</i> | Breastplate <i>mscript. die &amp; bored</i> |                         |
| Levels:                    | Preservation: <i>2</i>                                   | Grip                                        |                         |
| Slide No.:                 | Neg No.:                                                 | Hinge                                       |                         |
|                            |                                                          | Bracket                                     |                         |
|                            |                                                          | Fixing nails                                |                         |
|                            |                                                          | Shroud pins                                 |                         |
|                            |                                                          | Fabric                                      |                         |
|                            |                                                          | Other finds                                 |                         |

Description *adult pb coffin, E → W*

Discussion

Shape, dimensions and distinguishing characteristics

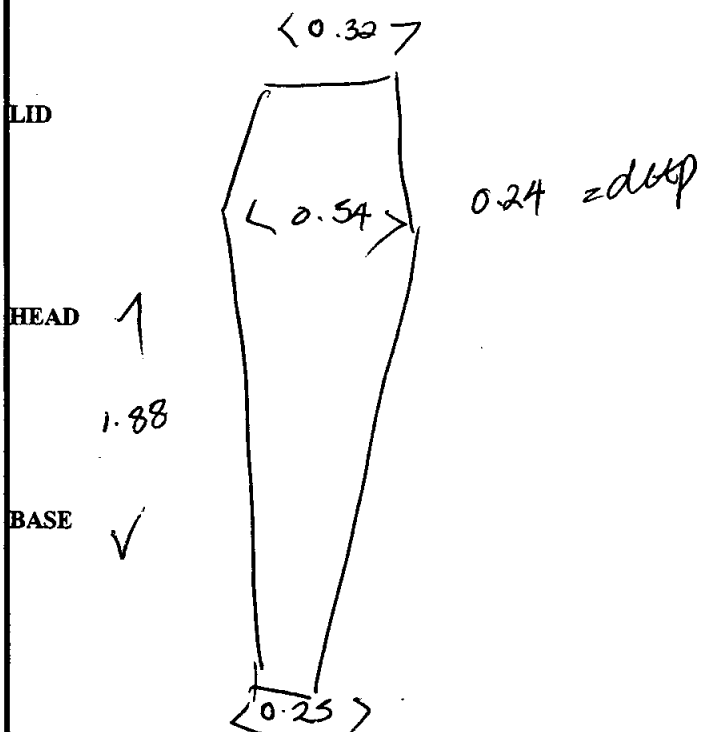

*MR John Smith  
Died 15 May  
1845  
In his 76 YR*



|                     |                   |           |
|---------------------|-------------------|-----------|
| Recorder: <i>Me</i> | Date: <i>6/12</i> | Initials: |
|---------------------|-------------------|-----------|

| SITE                | COFFIN RECORD SHEET                  | CONTEXT NO.                      |
|---------------------|--------------------------------------|----------------------------------|
| OLR00               |                                      | 1156                             |
| Trench:             | Additional sheets:                   | Treatment: BONES LIFTED          |
| Site sub-div: CRYPT | Grave fills:                         | ↳ DNA TAKEN                      |
| Plan no: 7          | Grave cut:                           | Finds                            |
| Section no:         | Skeleton:                            | None                             |
| Co-ordinates:       | Matrix location: Bay A, adj to 1155a | Breastplate ✓ (20) cu alloy (16) |
| Levels              | Preservation: 2                      | inscript. top. (2)               |
| Slide No.           | Neg No:                              | Grip                             |
|                     |                                      | Hinge                            |
|                     |                                      | Bracket                          |
|                     |                                      | Fixing nails                     |
|                     |                                      | Shroud pins                      |
|                     |                                      | Fabric                           |
|                     |                                      | Other finds                      |

Description: > dub pb coffin, E → W

Discussion

Shape, dimensions and distinguishing characteristics

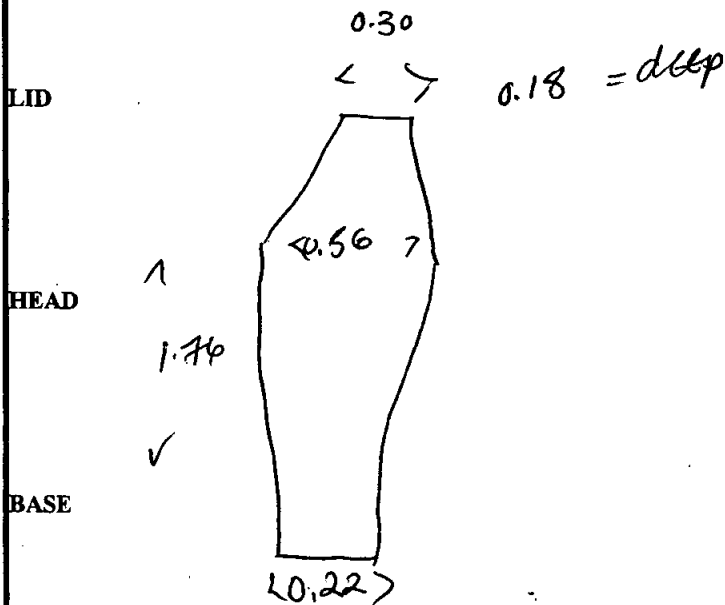

(20)  
 Elizabeth  
 Relict of  
 John former  
 Esq<sup>r</sup>  
 Died 29<sup>th</sup> May  
 1834  
 Aged 74 Years.

(16)  
 Elizabeth  
 Relict of  
 John former  
 Died 29<sup>th</sup> May  
 1834  
 Aged 74 Years.

|               |            |           |
|---------------|------------|-----------|
| Recorder: Mel | Date: 6/12 | Initials: |
|---------------|------------|-----------|

|                     |                                              |                                     |
|---------------------|----------------------------------------------|-------------------------------------|
| SITE<br>07R60       | COFFIN RECORD SHEET                          | CONTEXT NO.<br>1157.                |
| Trench:             | Additional sheets:                           | Treatment: BONES LIFTED & DNA TAKEN |
| Site sub-div: CRYPT | Grave fills:                                 |                                     |
| Plan no:<br>7       | Grave cut:                                   | Finds<br>None                       |
| Section no:         | Skeleton:                                    | Breastplate<br>inscrip top.<br>Grip |
| Co-ordinates:       | Matrix location: in Bay A, adj to US 6.1158. | Hinge<br>Bracket                    |
| Levels:             | Preservation:<br>2                           | Fixing nails<br>Shroud pins         |
| Slide No.:          | Neg No.:                                     | Fabric<br>Other finds               |

Description adult pb coffin. E → W

Discussion

Shape, dimensions and distinguishing characteristics

LID

HEAD

BASE

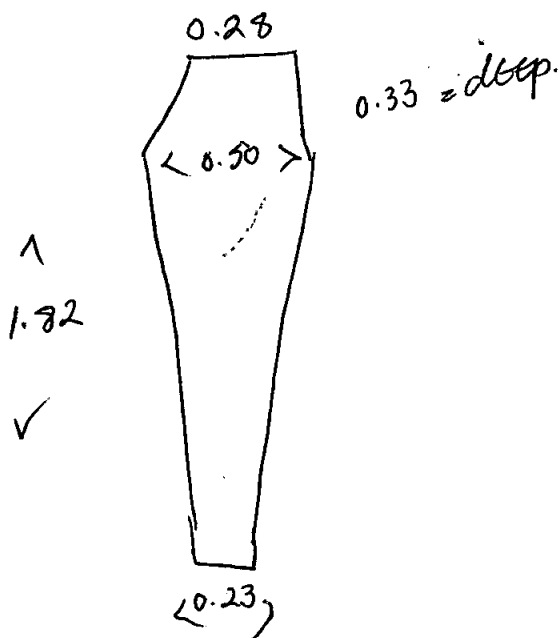

Peter Clarke  
Esq.  
Died 17th April  
1847  
Aged 78 Years.

Recorder: AMd

Date: 6/12

Initials: