



# Dallington Grange Northampton

## Archaeological Evaluation Report



June 2007

**Client: CgMs Consulting**  
**Client ref N°: 1443**

Issue N°: 1  
OA Job N°: 3614  
NGR: SP 725 635

**Client Name:** CgMs Consulting  
**Client Ref No:** 1443  
**Document Title:** Dallington Grange, Northampton  
**Document Type:** Evaluation  
**Issue Number:** 1

National Grid Reference: SP 725 635  
Planning Reference:

OA Job Number 3614  
Site Code: DALGR 07  
Invoice Code: DALGREV  
Receiving Museum:  
Museum Accession No:

Prepared by: Granville Laws  
Position: Project Officer  
Date: 1st June 2007

Checked by: Steve Lawrence  
Position: Senior Project Manager  
Date: 19th June 2007

Approved by: Nick Shepherd  
Position: Head of Fieldwork  
Date: 22nd June 2007

Signed



Document File Location  
Graphics File Location  
Illustrated by

**Disclaimer:**

*This document has been prepared for the titled project or named part thereof and should not be relied upon or used for any other project without an independent check being carried out as to its suitability and prior written authority of Oxford Archaeology being obtained. Oxford Archaeology accepts no responsibility or liability for the consequences of this document being used for a purpose other than the purposes for which it was commissioned. Any person/party using or relying on the document for such other purposes agrees, and will by such use or reliance be taken to confirm their agreement to indemnify Oxford Archaeology for all loss or damage resulting therefrom. Oxford Archaeology accepts no responsibility or liability for this document to any party other than the person/party by whom it was commissioned.*

**Oxford Archaeology**  
**© Oxford Archaeological Unit Ltd 2007**

Janus House  
Osney Mead  
Oxford OX2 0ES  
t: (0044) 01865 263800  
f: (0044) 01865 793496

e: [info@oxfordarch.co.uk](mailto:info@oxfordarch.co.uk)  
w: [www.oxfordarch.co.uk](http://www.oxfordarch.co.uk)

Oxford Archaeological Unit Limited is a Registered Charity No: 285627



# Dallington Grange, Northamptonshire

NGR SP 725 635

## *ARCHAEOLOGICAL EVALUATION REPORT*

### CONTENTS

<b>Summary .....</b>	<b>1</b>
<b>1 Introduction .....</b>	<b>1</b>
1.1 Location and scope of work .....	1
1.2 Topography and geology .....	1
1.3 Archaeological and historical background .....	2
<b>2 Evaluation Aims .....</b>	<b>5</b>
2.1 General site aims .....	5
2.2 Trench specific aims.....	6
<b>3 Evaluation Methodology.....</b>	<b>6</b>
3.1 Scope of fieldwork .....	6
3.2 Fieldwork methods and recording.....	7
3.3 Finds and palaeo-environmental evidence .....	7
3.4 Presentation of results .....	7
3.5 Monitoring.....	7
<b>4 Results: Descriptions.....</b>	<b>8</b>
4.1 Trench descriptions .....	8
4.2 Finds .....	14
<b>5 Discussion and Interpretation.....</b>	<b>19</b>
5.1 Reliability of field investigation.....	19
5.2 Overall interpretation .....	19
<b>Appendix 1 Archaeological Context Inventory .....</b>	<b>22</b>
<b>Appendix 2 Trench Overburden Depths and Geology Heights.....</b>	<b>26</b>
<b>Appendix 3 Bibliography and References .....</b>	<b>27</b>
<b>Appendix 4 Summary of Site Details .....</b>	<b>28</b>

### LIST OF FIGURES

Figure 1 Site location
Figure 2 Summary location plan of the current and previous investigations
Figure 3 Trench 32, Plan and Sections
Figure 4 Trench 33, Plan and Sections
Figure 5 Trench 34, Plan and Sections
Figure 6 Trench 35, Plan and Sections
Figure 7 Trench 37, Plan and Sections
Figure 8 Trench 38, Plan and Sections
Figure 9 Trench 39, Plan and Sections
Figure 10 Trench 40, Plan and Sections
Figure 11 Trench 41, Plan and Sections
Figure 12 Trench 42, Plan and Sections
Figure 13 Trench 45, Plan and Sections
Figure 14 Trench 46, Plan and Sections

## SUMMARY

*In April and May 2007, Oxford Archaeology (OA) undertook a targeted field evaluation on behalf of CgMs Consulting on arable land at Dallington Grange, Northamptonshire (NGR SP 725 635). Sixteen evaluation trenches were excavated targeted on known or suspected features and settlements. At the western side of the site the cropmarks of Sites 9 and 13 were demonstrated as being geological in origin. The linear cropmarks investigated by Trench 36 (Site 6) are also likely to be of natural origin. Sites 2 and 3 were confirmed as being of middle Iron Age and Roman date as established by previous evaluation although further clarification of the character of these settlements was not possible within the scope of this evaluation. Likewise, assessment of the causewayed enclosure was beyond the scope of this investigation although a curving ditch excavated within Trench 37 appears to respect the southern boundary of this monument. With the exception of Trench 35, significant plough truncation does not appear to have occurred within the excavated trenches.*

### 1 INTRODUCTION

#### 1.1 Location and scope of work

1.1.1 Between 16th April and 3rd May 2007, Oxford Archaeology (OA) undertook a targeted field evaluation on behalf of CgMs Consulting on farmland bordering the north-western side of Northampton centring on NGR SP 725 635 (Fig. 1). This represents the latest phase of archaeological evaluation within the site boundary following previous planning applications for the north-west bypass (application in 1995), residential development (December 1998) and a current application.

1.1.2 The archaeological work was undertaken in accordance with a Written Scheme of Investigation (WSI) produced by CgMs Consulting (2007) and follows a Project Design prepared by OA (OA 2007).

#### 1.2 Topography and geology

1.2.1 The site is located on the north-western edge of Northampton within an undulating landscape and is divided approximately in half by an axial ridge of high ground that traverses the area in a NW/SE direction. The highest point within the site boundary lies at c.100 m OD falling to c. 60 m OD on the valley floor of the River Nene along the eastern boundary of the site. To the west of the axial ridge the land falls to c. 80 m OD along the south-western boundary of the site formed by Dallington Brook.

1.2.2 Geological detail is provided by the British Geological Survey 1:50,000 series (Sheet 185: Northampton) which indicates that the site is dominated by Northampton Sand. On the high ground along the top of the ridge the Northampton Sand is overlain by the sequence of the Lower and Upper Estuarine Series culminating in the localised survival of Great Oolite Limestone in the extreme south-east of the site. Underlying the Northampton Sand, Upper Lias Clay deposits are present within the site

boundaries at the lowest contours along the extreme south-western and north-eastern boundaries coinciding with the edges of the River Nene and Dallington Brook valleys.

### 1.3 Archaeological and historical background

1.3.1 The archaeological potential of the site has been investigated as part of two previous planning applications. This has resulted in two separate evaluations prior to the current fieldwork. Both included fieldwalking, limited geophysical survey and trenched excavation (NAU 1990, OAU 1991). The line of the proposed north-western bypass that passes through the site has also been subject to a two-phase desk-based assessment (DBA) (NAU 1992 and 1993). Most recently extensive geophysical survey has been undertaken (ASDU 2006a and 2006b) to provide a clearer founding to the known cropmark features and evaluation results. The location of the current and previous evaluation trenches and the geophysical survey plot has been summarised in Figure 2.

1.3.2 The general archaeological background has been outlined by period in a DBA produced by CgMs Consulting (2006) summarising the various evaluations to date. The key points of this are repeated below with reference to findings of the earlier investigations where relevant. The site numbers referred to in the text below follow those of the CgMs Consulting DBA (2006) which do not necessarily correlate to earlier site number references from the previous evaluations.

#### *Neolithic*

1.3.3 Fieldwalking on the study site identified a general scatter of Neolithic and Bronze Age worked and burnt flint (OAU 1991). Across the eastern portion of the site this is most likely to represent items eroded from uphill locations as a result of hillwash and do not necessarily indicate sub-surface features (OAU 1991). However, to the west of site an area has been identified where the variety and quantity of worked flint tools coincides with evidence from cropmarks and geophysical survey that demonstrates the presence of a Neolithic causewayed enclosure (Figure 2 Site 1). This comprises a multi circuit of discontinuous ditches defining a large sub-circular central area. The Northampton Local Plan has designated these remains an 'Archaeological Area'. Accordingly, the Dallington Grange Planning Brief (2000) identified these remains for preservation *in situ*.

1.3.4 Around the northern and western perimeter of the causewayed enclosure, previous evaluation trenches have been targeted upon flint scatters identified during fieldwalking (OAU 1991). Trenches 1 and 15 both identified the enclosure ditch although this was only partly investigated in Trench 1 and revealed in plan (not excavated) in Trench 15 (*ibid.*). Pits containing a similar fill sequence as the excavated enclosure ditch were identified within Trench 25 on the western edge of the outer ditch circuit and could even reflect a discontinuous outer circuit. Although no finds were recovered from these the similarity in fill and proximity suggests that they are of a similar date.

- 1.3.5 Features that can be unequivocally dated to the Neolithic period have not been identified elsewhere on site within the scope of the previous evaluations.

### ***Bronze Age***

- 1.3.6 Evaluation trenching at the site did not identify any Bronze Age sub-surface remains, although some of the lithics collected during fieldwalking may date to this period. In October 2004 a metal detectorist discovered a Bronze Age hoard comprising of bronze axe heads, parts of a broken sword and pommel, together with ingots and assorted other materials. Northamptonshire Archaeology undertook an archaeological field survey in the area of the discovery (NAU 2004). It was established that the hoard was found within the north-western part of the study site, close to a smaller circular enclosure identified from air photo survey within the Neolithic causewayed enclosure. The enclosure is approximately 50m in diameter and has been interpreted as a possible late Neolithic or early Bronze Age henge monument. Indeed, it is known that Neolithic causewayed enclosures often served as a focus for ritual activity which extended into the Bronze Age.
- 1.3.7 Aerial survey has identified a ring ditch cropmark within the study site (Sites 6) and others in adjacent areas (Sites 15, 16 and 17) (CgMs 2006). The cropmarks may represent the remains of plough damaged burial monuments of Bronze Age date.
- 1.3.8 Although, it seems probable that a late Neolithic/early Bronze Age henge monument and Bronze Age burial monuments occur within the study site, there is little current evidence for Bronze Age settlement remains within the site other than lithics encountered within the topsoil and subsoil horizons.

### ***Iron Age***

- 1.3.9 The Iron Age is characterised in this region by increased settlement stability and the large-scale organisation of the landscape, developments that began in the late Bronze Age. Settlement evidence is plentiful and diverse, ranging from individual farmsteads occupied by a single household, to hillforts and enclosed settlements holding much larger communities.
- 1.3.10 Aerial survey, fieldwalking and evaluation trenching identified the remains of a middle/late Iron Age settlement (Site 2) occupying approximately 15 hectares within the southern part of the study site (NAU 1990). Geophysical survey has provided further information regarding the nature and extent of the settlement and possibly of more than one phase of occupation (ASDU 2006a and 2006b).
- 1.3.11 Within the remainder of the study site a second potential area of Iron Age settlement has been identified at Site 3. Although, the results of evaluation trenching confirmed that Site 3 represent the remains of a Roman farmstead, fieldwalking identified a concentration of Iron Age pottery suggesting the settlement had an Iron Age origin (OAU 1991).

- 1.3.12 Aerial survey has also identified a number of other cropmarks which may be of late prehistoric or Iron Age date. These include the cropmarks of possible pit alignments (Sites 7, 8, 9, 11 and 17) and two cropmarks of possible enclosures (Sites 5 and 6).

### ***Roman***

- 1.3.13 During the Roman period the study site lay c.1.5 km north of the Roman road which linked a settlement at Northampton with the Roman town of *Bannaventa* (Whilton Lodge).
- 1.3.14 An air photographic survey identified a small cropmark complex within the north-eastern part of the study site (Site 3). Fieldwalking and evaluation trenching has confirmed this to be of Roman date with a possible Iron Age origin. The features identified in the area of the cropmark comprised substantial ditches and a series of gullies suggesting stock enclosures, boundary features, possible trackways and a stone lined well indicating a small settlement area (OAU 1991).

### ***Saxon***

- 1.3.15 The character, extent and location of post Roman/Saxon settlement in the area is almost completely unknown. Although, the settlement and communication pattern that replaced the Roman one remains obscure, a complete abandonment of fertile agricultural land seems inconceivable.
- 1.3.16 During evaluation trenching in the vicinity of the Neolithic causewayed enclosure, a number of features were identified which cut through the prehistoric features and the Roman plough-damaged layer (Site 4). No dating evidence was recovered from the features although early Saxon pottery was recovered from the topsoil and buried ploughsoil during machine removal. It is therefore, suggested that the majority of these features are of early Saxon date (OAU 1991).

### ***Medieval***

- 1.3.17 In the 13th century Daventry and Northampton developed as important market centres, and with this came prosperity for the surrounding villages. These economic factors, allied to social and demographic trends, resulted in a further expansion of population and the area of cultivated land. As a result, the ploughing of open field strips was at a maximum and the acidic heathlands were correspondingly small during the 13th century. Decline in the 14th century resulted in the abandonment and shrinkage of settlement and agricultural land due in part to the Black Death.
- 1.3.18 The survival of insubstantial features cut through a Roman plough-damaged layer indicates that there has been little or no medieval or later ploughing on parts of the site (OAU 1991).
- 1.3.19 Later cartographic sources (1725 Inclosure Map: not reproduced here) marks Duston Heath and next to it, in Dallington, Rye Hill some 48 acres in extent. Indeed, some small areas particularly on Northampton Sand and Ironstone were suitable for growing rye and flax, and arable cultivation can be inferred. Geophysical survey has



identified areas of ridge and furrow. There is no evidence to suggest the study site was enclosed prior to the 17th century.

### ***Post-medieval & modern***

- 1.3.20 In this period cartographic and documentary evidence supplements evidence in the Northamptonshire Sites and Monuments Record (SMR).
- 1.3.21 During the medieval and post-medieval period the site encompassed parts of the parishes of Dallington and Harlestone. Initially the landscape was open, with the Parish boundaries forming the only significant field boundaries. However, in the 17th century, land within the parishes of Dallington and Harlestone was enclosed and the resulting landscape is shown on the 1662 Map and the 1725 Inclosure Map (not reproduced here).
- 1.3.22 The 1662 Map of Dallington shows two buildings within the north-eastern part of the study site. The buildings appear to correspond with Grange Farm (Site 18) and Lodge Farm (Site 19) of which the later has been demolished.
- 1.3.23 Study of the historical maps demonstrates that the majority of the site was in agricultural use during the post-medieval period. From the late 1480's until the 17th century the medieval open fields appear to have survived but in the 17th century land holdings were reorganised and enclosed fields were created. The majority of the post-medieval field boundaries were removed in the 1950's and 1960's.

## **2 EVALUATION AIMS**

### **2.1 General site aims**

- 2.1.1 The aims of the evaluation are specified in the WSI (CgMs 2007) and are repeated below.
- To determine, as far as reasonably practicable, the location, extent, date, character, condition, significance and quality of any surviving archaeological remains.
  - To establish the ecofactual and environmental potential of archaeological deposits and features encountered.
  - To clarify the impact of medieval and post-medieval ploughing and hence assess the degree of archaeological survival of buried deposits.
  - To clarify the presence and character of any Neolithic and/or Bronze Age activity associated with the causewayed enclosure.
  - To clarify the character of the Iron Age and Roman settlement evidence.
  - To clarify the character of Saxon settlement/activity on the site.

- To clarify the presence and character of any prehistoric, Iron Age, Roman, Saxon, and medieval agricultural activity.

## 2.2 Trench specific aims

2.2.1 Each of the trenches were specifically targeted on known or suspected features. The generic and overarching site aims are listed above whilst the list below summaries the reason for each location as outlined in the WSI (CgMs 2007).

- Trenches 31, 32 and 33. Positioned to investigate a series of linear features associated with Site 3. Previously investigated by OAU (1991) revealing Roman occupation.
- Trench 34. Positioned to investigate a pit alignment (Site 7). Previously identified by OAU (1991) in plan only.
- Trench 35. Positioned to investigate a pit alignment (Site 8). Previously identified by (OAU 1991) although the excavated pits remained undated.
- Trench 36. Positioned to investigate a series of undated cropmarks (Site 6).
- Trench 37. Positioned to investigate linear features potentially associated with the southern flank of Site 1.
- Trench 38. Positioned to investigate geophysical features identified by ASDU (2006) and the northern extent of Site 2.
- Trenches 39, 40 and 41. Positioned to investigate the clear geophysical features associated with Site 2. Site 2 has previously been subject to targeted evaluation by NAU (1990).
- Trench 42. Positioned to investigate an enclosure cropmark at Site 12.
- Trench 43. Positioned to investigate cropmarks at Site 13.
- Trench 44. Positioned to investigate cropmarks at Site 9.
- Trench 45. Positioned to investigate a very distinct cropmark (Site 11) to the south of Site 1.
- Trench 46. Positioned to investigate a rectilinear enclosure cropmark (Site 20).

## 3 EVALUATION METHODOLOGY

### 3.1 Scope of fieldwork

3.1.1 The evaluation comprised sixteen trenches (numbered 31 to 46), measuring between 20 m and 70 m and each 1.8 m wide (Fig. 2). Each trench was positioned to target specific features as outlined above. Following machine excavation of the 16 trenches, the results were subject to an initial review to identify the scope for a further 100 m<sup>2</sup> of trench to be excavated to clarify any of the aims listed above.

3.1.2 In the event Trenches 35, 36 and 37 were substantially enlarged and Trench 45 was slightly enlarged to define the character of the feature(s) encountered.

### 3.2 **Fieldwork methods and recording**

3.2.1 The trench locations were positioned by GPS according to the WSI produced by CgMs Consulting (2007). These were excavated by a JCB excavator fitted with a toothless ditching bucket to the top of the natural or to the top of the first archaeological horizon, whichever was encountered first. The overburden was removed under close archaeological supervision and scanned for any artefacts.

3.2.2 Where appropriate, the trenches were cleaned by hand and the revealed features were sampled to determine their extent and nature, to retrieve finds and assess their potential for environmental sampling. All archaeological features were planned and their sections drawn. Drawings were made at a scale of 1:20 or 1:50. All significant features were photographed using colour slide and black and white print film. Recording procedures followed those stated in the Project Design (OA 2007) detailed in the *OAU Fieldwork Manual* (ed. D. Wilkinson, 1992) and are consistent with the Institute of Field Archaeologists (IFA 2001) *Standard and Guidance for Field Evaluations*.

### 3.3 **Finds and palaeo-environmental evidence**

3.3.1 Finds were recovered by hand during the course of the evaluation and bagged by context. Finds of special interest were given a unique small find number. A metal detector survey was undertaken by experienced operators of the spoil produced from each trench and across the surface of the exposed archaeological horizon.

3.3.2 Two pits [4007] and [4604] were sampled for charred plant remains assessment.

### 3.4 **Presentation of results**

3.4.1 This report outlines the findings from each trench. Each evaluation trench has been described accompanied by relevant illustrated plans and sections where archaeological deposits and features were encountered. An inventory of all finds and contexts (which includes measurements not presented within the text) is provided in Appendix 1. Appendix 2 summarises the trench details of alignment, excavated length, depth of cultivation soil overburden and heights (m OD) of natural geology within each trench. Where relevant these details are also mentioned in the descriptions below.

### 3.5 **Monitoring**

3.5.1 In the absence of a County Archaeologist or other curatorial archaeologist, this work was monitored by CgMs Consulting on behalf of the landowners and developers.

## 4 RESULTS: DESCRIPTIONS

### 4.1 Trench descriptions

#### *Trenches 31, 32 and 33 (Site 3)*

- 4.1.1 Trenches 31, 32 and 33 were positioned to investigate an area of known cropmarks and faint geophysical features previously investigated by evaluation (OAU 1991). Sand or sandy silt natural (3103, 3203 and 3303) was encountered within in each trench.
- 4.1.2 Despite its proximity to Trench 12 which revealed the densest area of archaeological features within the 1991 evaluation (OAU 1991), Trench 31 (not illustrated) did not encounter any archaeological features or deposits.
- 4.1.3 Trenches 32 and 33 did reveal a series of ditches dominated by a NE/SW alignment consistent with the cropmark evidence. Within Trench 32 three ditches (3207, 3209 and 3213) were of broadly similar dimensions being between 2.00 m and 3.50 m wide and up to 0.80 m deep (Fig. 3). These contained similar fill sequences of homogenous orange brown clayey silts. At the southern end of the trench ditch 3225 was aligned NW/SE. This was also filled with orange silty clay deposits, the uppermost of which was truncated by a shallow ditch (3221) aligned on the predominate NE/SW orientation.
- 4.1.4 Two ditches (3304 and 3306) were encountered within Trench 33 (Fig. 4). These followed the character of those within Trench 32 with similar alignments, dimensions and fills all recorded. A single posthole (3308) was cut into the top of ditch 3306 after it had filled with silt.
- 4.1.5 A small assemblage of seven sherds (102 g) of pottery was recovered from all of the excavated deposits within Trenches 32 and 33 including a single sherd recovered from a buried cultivation soil (3302). Ditch 3209 produced two sherds of middle Iron Age representing the earliest material within this location whilst ditch 3213 produced a single sherd of Oxford colour coat of late Roman date. The remainder of the assemblage is consistent with a 1st- to 2nd-century AD date.
- 4.1.6 A buried cultivation soil (3202 and 3302) sealed the ditches and posthole. This was cut through by a pit or possible ditch (3206) at the north end of Trench 32. This was filled with redeposited natural (3204/3205) and, although no finds were recovered from these, it can be inferred that it is of relatively recent or post medieval date. The current ploughsoil (3201/3301) overlay the pit fills and buried cultivation soil.

#### *Trench 34 (Site 7)*

- 4.1.7 Trench 34 was positioned to investigate a cropmark pit alignment previously identified through evaluation (OAU 1991). A large pit (3406) representing this alignment along with a shallow ditch (3404) were encountered in the trench cut into the natural sand (3403) (Fig. 5).

- 4.1.8 The ditch was aligned NE/SW across the middle of the trench and was infilled by a single homogenous silty sand (3405).
- 4.1.9 At the western end of the trench a large circular pit (3406), with near vertical sides, was partially exposed. This was excavated to a depth of 0.50 m without encountering the base. The pit was not excavated further due to the combined depth of the feature and the surrounding deep overburden levels. The excavated fill comprised a single orange brown sandy silt (3407).
- 4.1.10 The fills of each feature were sealed by a buried cultivation soil (3402) that was overlain by the existing ploughsoil (3401). No finds were recovered from any of the feature fills or deposits within the trench.

### ***Trench 35 (Site 8)***

- 4.1.11 Trench 35 was positioned to examine a possible pit alignment previously identified but not excavated (OAU 1991). A clayey sand natural (3503) was encountered within this trench reflecting its higher elevation and the boundary between the Northampton Sand and Lower Estuarine Series. A single shallow and irregular feature 2.50 m across that was thought to be discolouration or variation of the geology was encountered in the centre of the trench (Fig. 6). Extension of the trench from its eastern end in a north-eastern direction encountered a similar feature (3504) filled by a more distinct orange brown sandy silt (3505) than that of the 'geological variation'. Excavation of this interpreted it as treehole due to its slightly irregular shape and uneven base. A single unidentified sherd of pottery was recovered from the fill.
- 4.1.12 Contrary to the site interpretations of these features, a review of their locations strongly suggests that these do in fact represent the continuation of the pit alignment albeit as very truncated remains.
- 4.1.13 The fills of each 'pit' were sealed by a buried cultivation soil (3502) that was overlain by the existing ploughsoil (3501).

### ***Trench 36 (Site 6)***

- 4.1.14 Trench 36 was positioned to examine a series of faint linear cropmarks and a distinct circular cropmark. Natural sand (3603) with areas of variation including ironstone and sandy limestone inclusions were investigated but no archaeological features or deposits were identified in the trench. The trench was also extended eastwards by c. 15 m in an attempt to identify the circular cropmark although this remained elusive.
- 4.1.15 The natural sand was overlain by a buried cultivation soil (3602) below the existing ploughsoil (3601).

### ***Trench 37***

- 4.1.16 Trench 37 was positioned along the south-eastern exterior side of the Neolithic causewayed enclosure to examine cropmarks that extend off or across the enclosure at this point. Two ditches (3704 and 3706) were identified cut into the natural sand

(3703) (Fig. 7). These correlate to the cropmarks with ditch 3706 identified after the trench was extended to the north-east by 22.5 m.

- 4.1.17 To the south-west end of the trench a narrow gully (3704) aligned NW/SE correlates to a curving cropmark that appears to arch off the outer circuit of the causewayed enclosure. The gully had a sharp 'V'- shaped profile and was filled by a very loose pale brown silty sand (3705).
- 4.1.18 At the north-eastern end of the trench ditch (3706) a broader ditch aligned NW/SE was revealed. This had stepped sides, a slightly concave base and was filled by a orange brown sandy silt (3707).
- 4.1.19 The fills of both features were sterile of finds and were overlain by a buried cultivation soil (3702), below the existing ploughsoil (3701).
- 4.1.20 A single flint scraper was recovered from the ploughsoil of this trench within the vicinity of gully 3704.

### ***Trench 38***

- 4.1.21 Trench 38 was positioned to investigate the northward extent of Site 2. A thin (0.12 m) sandy buried soil (3802) overlay natural sand (3803) and was cut through by a pit, a ditch and two gullies (Fig. 8). With the exception of an insignificant amount of animal bone recovered from the ditch, none of the excavated deposits produced any finds. Variation within the geology was also noted with a broad linear band of sandy limestone (3808) present aligned across the trench.
- 4.1.22 Gully 3812 was aligned east to west and was filled with a sandy silt (3813). This had been truncated by a broad, but similarly aligned, ditch (3809/3810) that terminated or possibly turned a sharp corner at its western end. This was filled with a brown sandy silt (3811/3817) that produced a small quantity of sheep/goat bone.
- 4.1.23 At the western end of the trench a pit (3814) was truncated by ditch 3810. The pit had near vertical sides and a rounded base and contained a similar fill (3815) to that of the ditch.
- 4.1.24 Gully (3806) was aligned SE/NW terminating to the north-east. This was of similar dimensions to gully 3812 although this was filled with a noticeably greyer deposits than the other features within the trench.
- 4.1.25 The existing ploughsoil (3801) directly sealed each feature without intervening buried cultivation soils being present.

### ***Trenches 39, 40 and 41 (Site 2)***

- 4.1.26 These trenches were positioned within an area of extensive settlement remains dating from the Iron Age period as defined by a previous evaluation (NAU 1990) and geophysical survey (ASDU 2006a and b). Natural sand and limestone was

encountered within each trench (3903, 4003 and 4103) through which all the features were cut.

- 4.1.27 A single very large ditch (3904) within Trench 39 reflects the location of a large ditched enclosure shown on the geophysical survey plot (Fig. 9). This was only partly excavated due to its size and likely depth although this clearly defined a NE/SW alignment and width in excess of 5.00 m. It was excavated to a depth of 1.00 m below the surface of the geology at which point a hint of a rounded edge to its southern side was encountered suggesting a possible butt end or entrance into the enclosure. The excavated part of the ditch was filled with loose sandy silts.
- 4.1.28 Within Trench 40 to the south of 39, a single ditch (4012) and two circular, straight-sided and flat-based pits (4004 and 4007) were encountered (Fig. 10). Pit 4004 was 0.90 m deep but had been backfilled, with the exception of a thin primary silt, in a single event. Pit 4007 differed containing three deposits present of equal thickness. The secondary fill (4008) within this sequence produced the largest pottery assemblage by count (19 sherds) and second largest by weight (257 g) from any feature of the evaluation. This also produced the second largest assemblage (by weight) of animal bone.
- 4.1.29 The ditch (4012) was aligned NW/SE to the south-west of pit 4004 and corresponds with an apparent linear boundary shown by the geophysical survey. The ditch was stepped across its upper profile with a sharp V-shaped lower profile. This was filled with orange brown silty sands (4013 and 4014) of which the upper fill was probably a backfill with original bank material. A small quantity of Iron Age pottery was retrieved from both ditch fills.
- 4.1.30 The densest concentration of features was encountered within Trench 41 (Fig. 11). These comprised ditches and pits cut into the natural although the sequence of ditches each followed the same alignment apparently recutting its predecessor. These were also aligned east to west obliquely along the line of the trench making clear definition of the features very difficult.
- 4.1.31 Due to the density of features only one of the two clear pits (4106) were excavated. This was of a similar appearance to pit 4007 with a flat base and vertical sides but contained a single backfill (4107).
- 4.1.32 The earliest ditch (4114/4118) increases in size along the line of the trench. To the east this is insubstantial at 0.4 m deep and 0.75 m wide. However at its western extent where it turns sharply to the north this enlarges to an unknown width and 0.55 m deep. Middle Iron Age pottery and a small tapering iron bar or rod were recovered from the silty infill of this ditch.
- 4.1.33 Two recuts were also recorded at the western end of this sequence. Ditch 4120 was just exposed within the northern edge of the trench and had steep sides and a flat base. A distinct limestone-rich deposit amongst a dark brown silty sand (4121) filled

this feature. A narrow gully (4116) with a sharp V- shaped profile truncated the western edge of ditch 4118.

- 4.1.34 Three ditches (4104, 4106 and 4108) were located towards the western end of the trench and were aligned NNE/SSW parallel to each other. Ditch 4108 was the largest of these with a broad flat base and steep sides. This was recut along its western edge by ditch 4110. Ditch 4104 was approximately 2.75 m to the north-west and could conceivably be part of a contemporary arrangement with one of the other ditches. Similar silting deposits filled each of these ditches and the largest assemblage by weight (10 sherds, 293 g) of middle Iron Age pottery was recovered from deposit 4105 filling ditch 4104.
- 4.1.35 Overall from the three trenches (Trenches 39, 40 and 41) positioned within the known Iron Age settlement a moderate sized assemblage of 55 sherds (771 g) of pottery was recovered from all of the sample excavated deposits. These indicate occupation within the middle Iron Age, probably between a 3rd-1st century BC date range.
- 4.1.36 All the features were sealed by a buried cultivation soil underlying the current topsoil.

#### ***Trench 42 (Site 12)***

- 4.1.37 Trench 42 was positioned to investigate a rectangular enclosure cropmark. A linear ditch (4204) probably forming the southern side of this enclosure and a pit (4206) were identified cut into the sand and ferruginous sandy limestone natural (4203) (Fig. 12).
- 4.1.38 The pit was only partly revealed within the limit of the trench and appeared to be circular with a 1.00 m diameter and 0.40 m deep. Excavation revealed a flat base and steeply sloped sides sealed by a primary silting deposit (4208). A darker orange brown deposit (4207) levelled the pit. Neither deposit produced any finds.
- 4.1.39 The ditch was of similar dimensions and aligned east to west. A single homogenous silting deposit (4205) filled the ditch and was also devoid of any finds.
- 4.1.40 Both features were overlain by a thin buried cultivation soil (4202) that also filled ploughscars cut into the undisturbed sand geology surface adjacent to the pit. The modern ploughsoil (4201) sealed the lower cultivation soil.

#### ***Trenches 43 (Site 13) and 44 (Site 9)***

- 4.1.41 Trenches 43 and 44 were positioned to investigate a series of cropmarks thought to represent pits and enclosures across the extreme western edge of the site. No archaeological features were encountered in either trench.
- 4.1.42 The natural geology across this area comprised mixed iron rich sand and sandy limestone that may have accounted for the dappled appearance of the cropmarks. A buried cultivation soil sealed by the present ploughsoil overlay the natural in Trench



43 and thin mixed contact zone separated the present ploughsoil and natural within Trench 44.

#### ***Trench 45 (Site 11)***

- 4.1.43 Trench 45 was positioned to investigate vivid cropmarks thought to represent a pit alignment to the south-west of the causewayed enclosure. Two large pits c. 2.75 m in diameter were revealed at the south-eastern end of the trench after this was expanded slightly to define if the features were indeed pits or a single ditch (Fig. 13).
- 4.1.44 Cleaning of the surface area and excavation of one pit (4504) revealed that these were separated by 0.75 m and cut into the natural sand and sandy limestone (4503). The pit had a flat base only 0.40 m in diameter rising with steep sides. These changed sharply to more gradual sloped sides indicating that the pit may have been left open to erosion forming the weathering cone appearance of the profile.
- 4.1.45 Two fills (4505 and 4506), both sterile of finds, suggest that the pit had filled via natural erosion rather than direct backfilling. A buried cultivation soil (4502) sealed the pits which was in turn overlain by the present ploughsoil (4501).

#### ***Trench 46 (Site 20)***

- 4.1.46 Trench 46 was positioned to investigate an enclosure cropmark approximately 280 m to the north the causewayed enclosure. A ditch (4604) and pit (4606) were revealed cut into the sand and limestone natural (4603) at the south-eastern end of the trench corresponding to the location of the cropmark (Fig. 14).
- 4.1.47 The ditch was aligned NE/SW and had a sharp V- shaped profile 0.80 m deep and 2.00 m wide. This was filled with a single deposit (4605) that produced two sherds (11 g) of pottery dated to the middle Iron Age.
- 4.1.48 The pit was circular, near vertical sided and flat based, and substantial at 2.00 m across and 0.90 m deep. This was filled with a greyish brown silty sand (4607) with stone lines indicating tipping or backfilling from the surface. Two sherds of middle Iron Age pottery (17 g) were also recovered from this feature along with two small fragments of fired clay.
- 4.1.49 Both the ditch and pit had straight well-defined sides showing little sign of erosion weathering suggesting that they were not open to the elements for prolonged periods.
- 4.1.50 A thin buried cultivation soil (4602) overlay the features and, in turn, was sealed by the present ploughsoil (4601).

## 4.2 Finds

4.2.1 Summary finds quantities and categories are listed in Table 1 below. Only the pottery and animal bone remains were of period significance and quantity to warrant specialist analysis. These reports are presented below. Summary descriptions of the other materials follow Table 1.

*Table 1*

Material	Fragment Count	Weight (g)
Pottery	70	966
Animal Bone	75	356
Clay pipe	17	42
Cu Alloy	1	7
Fired clay	2	5
Flint	1	16
Fe	1	30

4.2.2 Sixteen fragments of tobacco clay pipe stem were recovered from topsoil context 3701 and one fragment from a buried ploughsoil context (4102).

4.2.3 The Cu alloy find is of a post-medieval button with displaying an anchor and crown motif with a rope edging and was recovered from the ploughsoil (3201) of Trench 32.

4.2.4 An iron object was recovered from fill 4115 of ditch 4114 within Trench 41. This comprised a short (65 mm) tapered bar or rod with a square profile. Pottery recovered from the ditch suggests a middle Iron Age date for this object.

4.2.5 A single worked flint was recovered from the topsoil within Trench 37 (3701). This is a horseshoe-shaped scraper struck off a multi-platform core with a hard hammer. The curved sides of the tool display fine retouching and signs of use-wear.

4.2.6 Two irregular lumps of fired clay were recovered from fill 4607 of pit 4605 within Trench 46.

### ***The pottery***

*by Paul Booth (OA)*

4.2.7 Some 70 sherds (966 g) of pottery were recovered during the evaluation. The material was scanned rapidly and quantified using broad fabric/ware codes in the OA recording system for late prehistoric and Roman material. Diagnostic sherds were scarce but the majority of the material was of middle Iron Age date. The condition of the pottery was generally moderate to good. Sherd size was variable, but a number of sherds were quite large. Few were abraded and survival of surfaces was reasonably good. The pottery is summarised by context in Table 2.

Table 2: *Quantification of pottery (no. sherds/weight g) by period*

Context	Middle Iron Age	Roman	Post-medieval	Comment
3212	2/52			Reused base
3215		1/23		F51, 240-400
3223		1/5		R30
3302		1/7		E80
3309		2/15		R30, 2nd century
3505	1/1			Uncertain
3701			2/60	16th-17th century
3906	5/23			1 rim fragment
4006	4/33			
4008	19/257			1 sherd scored
4013	1/10			
4014	4/26			
4102			1/4	19th century
4105	10/293			1 jar rim
4107	1/30			jar rim
4115	7/43			1 jar rim
4119	3/19			
4121	1/37			
4605	2/11			
4607	2/17			
TOTAL	62/852	5/50	3/64	

*Middle Iron Age*

- 4.2.8 Pottery of this date was identified on general criteria of fabric and form. Fabrics were not examined in detail, but almost all sherds were characterised by the presence of voids suggestive of leached shell inclusions. In a few cases such inclusions survived. In other cases the density of voids was sufficient to indicate abundantly shell-tempered material, but more commonly such voids were small and sparse to moderate infrequency, associated with quartz sand or other inclusion types. Occasional sherds with clay pellet or possibly grog inclusions were also noted.
- 4.2.9 Diagnostic features were scarce. Only four rim sherds were present, all probably from jars, though one was too small for confident identification. Two vessels had simple roughly upright rims while that in context 4105 was slightly everted, from a shouldered, quite wide mouthed jar. A single large sherd in context 4008 had scored decoration. Occasional (usually small) sherds in sand-tempered fragments had burnished surfaces.
- 4.2.10 Evidence of sooting survived rarely, but was noted on at least two sherds. Other evidence for use was seen on a shell-tempered base in context 3212. This had been trimmed above, rather than at (as is more normal), the angle of the base and body wall, to produce a small dish-like object 25 mm tall.
- 4.2.11 The Iron Age pottery was relatively widely distributed, occurring in Trenches 32, 39, 40, 41 and 46, although the bulk of the material was concentrated in Trenches 40 and 41.

*Roman*

- 4.2.12 Only five Roman sherds were found, all in Trenches 32 and 33. A single grog-tempered (E80) sherd in context 3302 could date to either side of the Roman conquest but is the only likely 1st century piece from the site. Three sherds in a fairly fine sand tempered reduced ware (R30) are probably of local origin and include an angled everted rim sherd suggesting a late 1st-2nd century date. A single sherd of Oxford colour-coated ware (F51) from context 3215 was a rim of Young (1977) type C49, but this cannot be dated more closely than AD 240-400.

*Post-medieval*

- 4.2.13 Only three post-medieval sherds were recovered; none from stratified contexts.

*Discussion*

- 4.2.14 The Iron Age pottery is typical of what might be expected in the area both in terms of fabric and form in the middle Iron Age. The small size of the assemblage does not permit close dating, but a 3rd-1st century BC range seems likely. Some of the components of the assemblage are found in Knight's 'earlier La Tène' regional ceramic phase, dated to the 5th-3rd centuries BC (Knight 2002, 131), but styles such as scored ware were probably in use well into the 1st century BC (*ibid.*, 134). It is, however, clear that, with the possible exception of a single sherd in 3302, characteristic late Iron Age material of 'Belgic' character is entirely absent. Assemblages of this character are known in the Northampton area, as for example at Blackthorn (Williams 1974, 56), whereas at Moulton, some 5 km east of the present site, both middle and late Iron Age material was present (*ibid.*, 20-39).

*Animal bone*

by Lena Strid (OA)

- 4.2.15 A total of 75 animal bones were recovered from this site (see Table 3). Most bones were in a good condition with almost 95% being grade 1 or 2 (see Lyman 1994:355 for definitions) (see Table 4). Burned bones were absent, and only two bones displayed gnaw marks.
- 4.2.16 The predominance of cattle and sheep/goat in the assemblage is to be considered normal, regardless of time period. The presence of dogs is evidenced by gnaw marks. Of the twelve sheep/goat bones, one mandible could be determined to be sheep.
- 4.2.17 Judging by the size and surface structure, the cattle and sheep/goat bones derived from sub-adult or adult animals.
- 4.2.18 Butchering marks were found on one medium mammal long bone, which had been split longitudinally, suggesting marrow extraction.
- 4.2.19 Pathologies were found on a cattle radius, on which the ulna had fused just below the joint surface.

4.2.20 No further information can be gained from such a small sample of bones.

Table 3. Bone assemblage from DALGR07.

	Cattle	Sheep/goat	Sheep	Horse	Medium mammal	Large mammal	Indet.
Mandible	1		1	2			
Loose teeth	4	7		2			
Rib					7	1	
Humerus		1					
Radius	1						
Metapodial		2					
Long bone					6	4	
Indeterminate							41
<b>TOTAL</b>	<b>6</b>	<b>11</b>	<b>1</b>	<b>4</b>	<b>7</b>	<b>5</b>	<b>41</b>
Weight (g)	168	19	6	76	13	38	36

Table 4. Preservation level for bones from the DALGR07 assemblage.

N	0	1	2	3	4	5
75		46.7%	48.0%	4.0%	1.3%	

Table 5. Number of bones and weight per context

Context	Species	No. of bones (refitted)	Sum of weight (g)
3223	Indeterminate	1	0
3309	Cattle	1	7
3811	Sheep/goat	4	0
3906	Indeterminate	2	0
4006	Medium mammal	1	11
	Indeterminate	9	
4008	Cattle	2	70
	Indeterminate	5	
4105	Sheep/goat	1	18
	Medium mammal	1	
	Large mammal	1	
	Indeterminate	3	
4107	Cattle	1	4
4115	Cattle	1	152
	Sheep/goat	6	
	Sheep	1	
	Horse	4	
	Medium mammal	4	
	Large mammal	1	
	Indeterminate	16	
4117	Cattle	1	64
4119	Medium mammal	6	7
	Indeterminate		
4121	Large mammal	3	23

### ***Charred Plant remains***

by Luke Howarth with Dr Wendy Smith and Dr Rebecca Nicholson(OA)

4.2.21 Samples were taken for environmental assessment from fill 4008 (Trench 40 Pit 4007) and fill 4607 (Trench 46 Pit 4606) within. Both were processed by water flotation for charred plant remains (CPR). Small bones and other ecofacts and artefacts are also recovered by this process. Both samples comprised 40 litres of sediment.

#### *Methodology*

4.2.22 The samples were processed for CPR by mechanical flotation in a modified Siraf-type machine, with the sample held on a 500 µm mesh and the flot collected on a 250 µm mesh. Once the majority of CPR had floated off, the residual material was passed through a stack of sieves 10-4 mm, 4-2 mm and 2-0.5 mm.

4.2.23 The flots and residues were air-dried and the residues sorted by eye. The flots were passed through a 2 mm sieve and fragments of wood or CPR extracted. Charcoal >2 mm in diameter was examined under a binocular microscope at x 10 and x 20 magnification (transverse section). While this provides a reliable method of the identification for ring porous taxa (eg. *Quercus* sp.), identifications are tentative for the semi- to diffuse-porous taxa (*Maloideae*, *Prunus* etc.).

#### *Results*

4.2.24 Both flots contained large amounts of modern plant remains and insects. Some charred grain and wood was also present. Charred grains of wheat (possibly spelt wheat, *Triticum spelta*) alongside undifferentiated cereal grains were identified from pit fill 4008. Other material included charred seeds from docks (*Rumex* sp.) and oraches (*Chenopodium* spp.). The majority (~70%) of the charred plant remains from this deposit however were charcoal fragments identified as oak (*Quercus* sp.).

4.2.25 Pit fill 4607 contained a smaller but much more varied CPR assemblage. Small charcoal fragments of *Quercus* sp. (oak) dominated the assemblage (~80%) but were accompanied by bromus grass (*Bromus* sp.), hulled barley grains (*Hordeum* sp.), grains of spelt (*Triticum spelta*) and emmer wheat (*Triticum dicoccum*). A glume base possibly deriving from either *T. spelta* or *Triticum dicoccum* was also identified.

4.2.26 The heavy residues from both samples contained very few ecofactual remains. A few fragments of mammal bone were recovered from fill 4008 although no bone was recovered from fill 4607. Both samples contained considerable amounts of modern plant remains including seeds and roots. Each also contained a variety of insect remains that appeared to be of modern origin.

#### *Discussion*

4.2.27 The samples appear to represent limited environmental potential in terms of sizeable flot assemblages, although identifiable remains were present in both. These indicate

that varied plant resources were utilised with incidental or secondary species also represented allowing limited interpretation of the surroundings. As the potential for waterlogged remains at the site is very limited, CPRs could provide the most reliable source of environmental evidence.

## 5 DISCUSSION AND INTERPRETATION

### 5.1 Reliability of field investigation

5.1.1 Site conditions during the evaluation were generally good and the archaeological features were clearly visible cut into the geology. Within the sand geology the fills of some features had become very leached and difficult to define although this did not affect the primary identification of these features.

5.1.2 Each trench was able to clearly define the presence/absence of the targeted features and, considered alongside the results of the previous evaluations, has the ability to inform on the original aims. However, it should also be noted that finds were generally scarce or absent from the areas outside of the Iron Age and Roman settlements. The associations between these features and the dated remains is discussed further below.

### 5.2 Overall interpretation

5.2.1 Two general themes are identified in the site specific aims outlined by the WSI and listed above. These are the identification and impact of ploughsoils and historical ploughing and the characterisation of settlement and activity in relation to period.

#### *Historical ploughing and buried cultivation horizons*

5.2.2 The impact of the historical ploughing is most evident in the depth of ploughsoil recorded sealing the excavated features. Clearly substantial movement of soil has occurred reflecting the topography of the site with the trenches positioned within dry valleys, at the base of slopes or on shallow slopes below the high ground each having increased depths of ploughsoil overburden. Trenches 31 to 35 recorded ploughsoil overburden depths up to 1.60 m.

5.2.3 The implications of ploughsoil movement are two-fold. Firstly for the point of origin of the soil. This has clearly derived from the higher ground and steepest inclinations resulting in a continuous process reducing the preservation levels truncating or even removing any remains within these areas. However, the ridge of high ground has not been substantially tested through evaluation making it difficult to draw any firm conclusions of the actual preservation levels here. Within the current evaluation, Trench 35 did suggest that some features may have been heavily truncated. Here the pit alignment previously evaluated by OAU (1991) appears to have been substantially removed through truncation at its southern extent. Trench 27, positioned approximately 40 m north of Trench 35, has identified pits up to 1.40 m deep associated with this cropmark (ibid.). Trenches 6 and 26, positioned 87 m and 236 m

to the south of Trench 35, failed to produce any evidence of archaeological remains. This could indicate truncation levels of 1 m plus with the pits being virtually removed as the alignment progresses upslope. However, caution must be exercised here without substantial further data to test this hypothesis.

5.2.4 The reverse of this situation applies to the deposition areas of the ploughsoils downslope. The ditches present within Trenches 32 and 33 suggest that initial truncation is likely to have occurred here as demonstrated by the lack of any buried soil horizons that predate the features. However, as the ploughsoil accumulated over the features, this in turn protected them from further plough truncation. It should be noted that postholes or similar small features are absent from the trenches that could indicate a degree of truncation although the 1991 evaluation (OAU 1991) did encounter a stone constructed drain within Trench 12 which is unlikely to have originally been constructed at any substantial depth. Therefore the potential for the preservation of smaller features here remains reasonably good.

5.2.5 Within Site 2 deep levels of ploughsoil were not encountered. The northern portion of the site is situated at a height of c. 97 m OD and slopes to the south with Trench 40 positioned on the apparent southern extent on the 90 m OD contour. Preservation levels within the trenches appears consistent with ditches and pits of similar dimensions present. The extent of the actual settlement has been previously investigated in more detail by NAU (1990). The current evaluation concurs with the findings of the previous evaluation which also provided evidence for localised excellent levels of preservation through structures being terraced into the slope.

5.2.6 As a general observation within the current evaluation it is reasonable to suggest that deep ploughing has not had an overly significant impact upon the features targeted, possibly with the exception of the pit alignment within Trench 35.

5.2.7 No significant cultivation horizons prior to the assumed medieval, post-medieval and modern deposits were identified. A thin buried soil horizon was encountered in Trench 38 and was cut through by a series of undated features. These may be of Iron Age date relating to the nearby Site 2 although the precise character of the soil was not established. It may merely represent a leached contact zone with the underlying sand geology.

### ***Settlement characterisation***

#### *Early Prehistoric*

5.2.8 A single Trench (37) was excavated in close proximity to the causewayed enclosure. The two ditches encountered here are undated although the geophysical survey and cropmark plots provide some indication as to their associations. At the north-eastern end of the trench ditch 3706 clearly relates to a linear cropmark that is aligned NW/SE across the north-eastern interior of the causewayed enclosure. The 1886 OS map shows field boundaries at this point and this ditch almost certainly reflects this.



- 5.2.9 Ditch 3704 has less distinct associations. The cropmarks and geophysical survey both show that this closely follows and curves around the southern side of the causewayed enclosure. Although associated artefacts were not present its apparent association with the enclosure does suggest it was part of a contemporary arrangement.
- 5.2.10 Identification of activity associated with the causewayed enclosure on a broader scale was not possible due to the very limited number of trenches that have been excavated in all evaluations within its vicinity. Indeed only five trenches have been excavated within a 200 m radius of the centre point of the enclosure. The densest area of evaluation represented by Trenches 1, 2, 15 and 25 did identify the enclosure although should not be seen as a reasonable assessment of the immediate surroundings of the enclosure as a whole.
- 5.2.11 Further clarification of early prehistoric activity within the development boundary can not be made at this point either in relation to the causewayed enclosure or the areas that largely remain to be sampled by evaluation. To the immediate south-west of the enclosure a c. 14 ha area has only had a single 20 m long trench excavated within it. Clearly given the often sparse nature of remains from these periods few conclusions can be made about the potential of this area.

#### *Iron Age and Roman*

- 5.2.12 With regard to Sites 2 and 3, the current evaluation concurs closely with the previous evaluations results (NAU 1990, OAU1991). The pottery results of all are entirely consistent with material spanning the Roman period recovered from Site 3 and the middle Iron Age from Site 2 in comparative investigations. Without further evaluation to test the extent of Site 3 or the interior of Site 2 little more can be concluded from the current evidence.

#### *Saxon*

- 5.2.13 No evidence for Saxon activity was encountered within the current evaluation. However, the only previously reported evidence for this period is from Trench 2 and this was in the form of unstratified pottery, undated features and a possible Roman soil layer (OAU 1991). The nearest trench excavated within the current evaluation was 170 m to the north of Trench 2.
- 5.2.14 The same principles of identifying and characterising any activity to this period apply as those discussed for the early Prehistoric period.

## APPENDICES

## APPENDIX 1 ARCHAEOLOGICAL CONTEXT INVENTORY

Ctxt. No.	Type	Length (m)	Thick./Depth (m)	Comment	Finds	Spot Date
Trench 31						
3101	Layer		0.3	Topsoil	-	
3102	Layer		0.15	Subsoil	-	
3103	Deposit			Natural geology	-	
Trench 32						
3201	Layer		0.35	Topsoil	Button	
3202	Layer		0.15	Subsoil	Pottery	
3203	Deposit			Natural geology	-	
3204	Fill		0.4	Fill of pit 3206	-	
3205	Fill		0.3	Fill of pit 3206	-	
3206	Cut	1.6	0.6	Pit	-	
3207	Cut	3.6	0.55	Ditch	-	
3208	Fill		0.55	Fill of ditch 3207	-	
3209	Cut	1.9	0.55	Ditch	-	
3210	Fill		0.2	Fill of ditch 3209	-	
3211	Fill		0.3	Fill of ditch 3209	-	
3212	Fill		0.3	Fill of ditch 3209	Pottery	
3213	Cut	1.6	0.61	Ditch	-	
3214	Fill		0.4	Fill of ditch 3213	-	
3215	Fill		0.21	Fill of ditch 3213	Pottery	
3216	Fill		0.28	Fill of ditch re-cut 3219	-	
3217	Fill		0.2	Fill of ditch 3218	-	
3218	Cut	1.2	0.2	Ditch	-	
3219	Cut	1.8	0.55	Ditch re-cut	-	
3220	Fill		0.55	Fill of ditch re-cut 3219	-	
3221	Cut	1.2	0.2	Ditch	-	
3222	Fill		0.2	Fill of ditch 3221	-	
3223	Fill		0.2	Fill of ditch 3225	Pottery Bone	
3224	Fill		0.15	Fill of ditch 3225	-	
3225	Cut	1.0	0.45	Ditch	-	
3226	Fill		0.38	Fill of ditch 3207	-	
3227	Cut	0.9	0.4	Ditch	-	
3228	Fill		0.4	Fill of ditch 3227	-	
Trench 33						
3301	Layer		0.45	Topsoil	-	
3302	Layer		0.4	Subsoil	Pottery	
3303	Deposit			Natural geology	-	
3304	Cut	0.9	0.2	Ditch	-	
3305	Fill		0.2	Fill of ditch 3304	Pottery	
3306	Cut	1.6	0.4	Ditch	-	
3307	Fill		0.4	Fill of ditch 3306	-	
3308	Cut	0.4 Diam.	0.35	Posthole	-	
3309	Fill		0.35	Fill of posthole 3308	Pottery Bone	
Trench 34						
3401	Layer		0.33	Topsoil	-	

Ctxt. No.	Type	Length (m)	Thick./Depth (m)	Comment	Findings	Spot Date
3402	Layer		1.1	Subsoil / Hill wash	-	
3403	Deposit			Natural geology	-	
3404	Cut	1.04	0.52	Ditch	-	
3405	Fill		0.52	Fill of ditch 3404	-	
3406	Cut	2.3 Dia	0.55	Pit	-	
3407	Fill		0.55	Fill of pit 3406	-	
<b>Trench 35</b>						
3501	Layer		0.35	Topsoil	-	
3502	Layer		0.3	Subsoil	-	
3503	Deposit			Natural geology	-	
3504	Cut	1.8 x 0.7	0.36	Tree-throw hole	-	
3505	Fill		0.36	Fill of TTH 3504	Pottery	
<b>Trench 36</b>						
3601	Layer		0.3	Topsoil	-	
3602	Layer		0.2	Subsoil	-	
3603	Deposit			Natural geology	-	
3604	Layer		0.4	Natural geology	-	
<b>Trench 37</b>						
3701	Layer		0.4	Topsoil	Pottery Flint CTP	
3702	Layer		0.2	Subsoil	-	
3703	Deposit			Natural geology	-	
3704	Cut	0.4	0.32	Gully	-	
3705	Fill		0.32	Fill of gully 3704	-	
3706	Cut	1.62	0.56	Ditch	-	
3707	Fill		0.56	Fill of ditch 3706	-	
<b>Trench 38</b>						
3801	Layer		0.35	Topsoil	-	
3802	Layer		0.10	Subsoil	-	
3803	Deposit			Natural geology	-	
3804	Cut	1 m	0.3	Ditch	-	
3805	Fill		0.3	Fill of ditch 3804	-	
3806	Cut	0.38	0.13	Gully	-	
3807	Fill		0.13	Fill of gully 3806	-	
3808	Layer		0.25	Natural geological layer	-	
3809	Cut	0.6	0.42	Ditch	-	
3810	Cut	0.9	0.38	Ditch	-	
3811	Fill		0.38	Fill of ditch 3810	Bone	
3812	Cut	1 m	0.15	Ditch	-	
3813	Fill		0.15	Fill of ditch 3812	-	
3814	Cut	0.7	0.4	Pit	-	
3815	Fill		0.32	Fill of pit 3814	-	
3816	Fill		0.25	Fill of pit 3814	-	
3817	Fill		0.4	Fill of ditch 3809	-	
<b>Trench 39</b>						
3901	Layer		0.3	Topsoil	-	
3902	Layer		0.55	Subsoil	-	
3903	Deposit			Natural geology	-	
3904	Cut	4.2 Dia	0.86	Pit	-	

Ctxt. No.	Type	Length (m)	Thick./Depth (m)	Comment	Findings	Spot Date
3905	Fill		0.82	Fill of pit 3904	-	
3906	Fill		0.8	Fill of pit 3904	Pottery Bone	
<b>Trench 40</b>						
4001	Layer		0.35	Topsoil	-	
4002	Layer		0.15	Subsoil	-	
4003	Deposit			Natural geology	-	
4004	Cut	1 m Dia	0.86	Pit	-	
4005	Fill		0.08	Fill of pit 4004	-	
4006	Fill		0.8	Fill of pit 4004	Pottery Bone	
4007	Cut	1.5 m dia	0.5	Pit	-	
4008	Fill		0.25	Fill of pit 4007	Pottery Bone	
4009	Fill		0.18	Fill of pit 4007	-	
4010	Fill		0.12	Fill of pit 4007	-	
4011	Fill		0.4	Fill of pit 4007	-	
4012	Cut	2.15	0.79	Ditch	-	
4013	Fill		0.25	Fill of ditch 4012	Pottery	
4014	Fill		0.5	Fill of ditch 4012	Pottery	
<b>Trench 41</b>						
4101	Layer		0.34	Topsoil	-	
4102	Layer		0.35	Subsoil	Pottery	
4103	Deposit			Natural geology	-	
4104	Cut	0.6	0.44	Ditch	-	
4105	Fill		0.44	Fill of ditch 4104	Pottery Bone	
4106	Cut	1.64 m Dia	0.64	Pit	-	
4107	Fill		0.64	Fill of pit 4106	Pottery Bone	
4108	Cut	1 m	0.47	Ditch	-	
4109	Fill		0.47	Fill of ditch 4108	-	
4110	Cut	0.6	0.6	Ditch	-	
4111	Fill		0.6	Fill of ditch 4110	-	
4112	Cut	1.3	0.2	Ditch	-	
4113	Fill		0.2	Fill of ditch 4112	-	
4114	Cut	0.95	0.34	Ditch	-	
4115	Fill		0.34	Fill of ditch 4114	Pottery Bone Iron obj	
4116	Cut	0.58	0.38	Gully	-	
4117	Fill		0.38	Fill of gully 4116	Bone	
4118	Cut	1.16	0.6	Ditch	-	
4119	Fill		0.6	Fill of ditch 4118	Pottery Bone	
4120	Cut		0.8	Ditch	-	
4121	Fill		0.8	Fill of ditch 4120	Pottery Bone	
<b>Trench 42</b>						
4201	Layer		0.3	Topsoil	-	
4202	Layer		0.1	Subsoil	-	
4203	Deposit			Natural geology	-	
4204	Cut	1.3	0.46	Ditch	-	

Ctxt. No.	Type	Length (m)	Thick./Depth (m)	Comment	Findings	Spot Date
4205	Fill		0.46	Fill of ditch 4204	-	
4206	Cut	0.94 m Dia	0.39	Pit	-	
4207	Fill		0.18	Fill of pit 4206	-	
4208	Fill		0.12	Fill of pit 4206	-	
Trench 43						
4301	Layer		0.26	Topsoil	-	
4302	Layer		0.23	Subsoil	-	
4303	Deposit			Natural geology	-	
Trench 44						
4401	Layer		0.44	Topsoil	-	
4402	Layer		0.1	Subsoil	-	
4403	Deposit			Natural geology	-	
Trench 45						
4501	Layer		0.32	Topsoil	-	
4502	Layer		0.15	Subsoil	-	
4503	Deposit			Natural geology	-	
4504	Cut	2.7 m Dia	0.95	Pit	-	
4505	Fill		0.24	Fill of pit 4504	-	
4506	Fill		0.72	Fill of pit 4504	-	
Trench 46						
4601	Layer		0.32	Topsoil	-	
4602	Layer		0.15	Subsoil	-	
4603	Deposit			Natural geology	-	
4604	Cut	2.1	0.8	Ditch	-	
4605	Fill		0.8	Fill of ditch 4604	Pottery	
4606	Cut	1.65 m Dia	0.85	Pit	-	
4607	Fill		0.85	Fill of pit 4206	Pottery Daub	

**APPENDIX 2 TRENCH OVERBURDEN DEPTHS AND GEOLOGY HEIGHTS**

Trench No.	Alignment	Length	Thick./Depth of Overburden	Surface of geology (m OD)
31	NE/SW	30 m	NE 0.40 m, SW 0.56 m	NE 77.20 m, SW 76.90 m
32	N/S	50 m	N 0.80 m, S 0.40 m	N 77.80 m, S 79.30 m
33	NW/SE	30 m	NW 0.70 m, SE 0.50 m	NW 74.00 m, SE 74.30 m
34	E/W	20 m	E 1.44 m, W 0.85 m	E 80.10 m, W 81.07 m
35	E/W & NE/SW	40 m (combined)	E 0.64 m, W 0.60 m	E 87.35 m, W 87.20 m
36	E/W	85 m	E 0.60 m, W 0.55 m	E 88.23 m, W 87.64 m
37	NE/SW	92.5 m	NE 0.40 m, SW 0.50 m	NE 97.60 m, SW 96.15 m
38	SE/NW	30 m	SE 0.30 m, NW 0.40 m	SE 100.40 m, NW 99.50 m
39	NW/SE	50 m	NW 0.90 m, SE 0.57 m	NW 93.10 m, SE 93.40 m
40	NE/SW	30 m	NE 0.40 m, SW 0.50m	NE 91.05 m, SW 89.25 m
41	ESE/WNW	50 m	ESE 0.40 m, WNW 0.60 m	ESE 95.66 m, WNW 95.45 m
42	N/S	25 m	N 0.35 m, S 0.45 m	N 90.20 m, S 88.90 m
43	NW/SE	30 m	0.40 - 0.50 m	93.60 m
44	N/S	40 m	0.45 m	N 96.03 m, S 96.26 m
45	NE/SW	20 m	NE 0.58 m, SW 0.45 m	NE 90.40 m, SW 89.95 m
46	NW/SE	20 m	NW 0.47 m, SE 0.42 m	NW 83.40 m, SE 83.18 m

**APPENDIX 3 BIBLIOGRAPHY AND REFERENCES**

- ASDU, 2006b Dallington Grange, Northamptonshire: geophysical survey. Archaeological Services Durham University unpublished client report June 2006
- ASDU, 2006b Dallington Grange, Northamptonshire: geophysical survey phase 2. Archaeological Services Durham University unpublished client report September 2006
- CgMs, 2006 Cultural Heritage Desk Based Assessment Dallington Grange, Northamptonshire. Cg Ms Consulting unpublished client report October 2006
- CgMs, 2007 Specification and Written Scheme of Investigation for an Archaeological Field Evaluation: Dallington Grange, Northamptonshire. Cg Ms Consulting unpublished document March 2007
- IFA, 2001 *Standard and Guidance for Archaeological Evaluations*
- Lyman, R L, 1996 *Vertebrate taphonomy*. Cambridge University Press, Cambridge.
- Knight, D, 2002 A regional ceramic sequence: pottery of the first millenium BC between the Humber and the Nene, in A Woodward and J D Hill (eds), *Prehistoric Britain: The ceramic basis*, Prehistoric Ceramics Research Group Occ Pub **3**, Oxford, 119-142.
- NAU, 1990 Archaeological Evaluation at Kings Heath, Northampton. Northamptonshire Archaeological Unit unpublished client report October 1990
- NAU, 1992 Northampton, North-West Bypass. Archaeological Survey Stage 1. Northamptonshire Archaeological Unit unpublished client report September 1992
- NAU, 1993 Northampton, North-West Bypass. Archaeological Survey Stage 2. Northamptonshire Archaeological Unit unpublished client report May 1993
- NAU, 1998 Geophysical Reconnaissance Survey at Dallington Grange, Northampton. Northamptonshire Archaeological Unit unpublished client report May 1998
- NAU, 2004 Kings Heath, Whitelands, Northampton: Northampton, Archaeological Field Investigation. Northamptonshire Archaeological Unit unpublished client report January 2005
- OA, 1992 *Fieldwork Manual* (ed. D Wilkinson, first edition, August 1992)
- OA, 2007 Dallington Grange, Northamptonshire. Project Design and Method Statement for an Archaeological Evaluation. 1991Oxford Archaeology unpublished document April 2007
- OAU, 1991 Kings Heath Whitelands, Northampton. Archaeological Evaluation Report. Oxford Archaeological Unit unpublished client report June
- Williams, J H (ed), 1974 *Two Iron Age sites in Northampton*, Northampton Development Corporation Archaeological Monographs No **1**, Northampton.
- Young, C J, 1977 *The Roman pottery industry of the Oxford region*, Brit Archaeol Rep (Brit Ser) **43**, Oxford.

**APPENDIX 4 SUMMARY OF SITE DETAILS****Site name:** Dallington Grange, Northampton**Site code:** DALGR 07**Grid Reference:** SP 725 635**Type of evaluation:** 16 Trenches of varying length**Date and duration of project:** 16th April to 3rd May 2007**Area of site:** 227 ha.**Summary of results:**

In April and May 2007, Oxford Archaeology (OA) undertook a targeted field evaluation on behalf of CgMs Consulting on arable land at Dallington Grange, Northamptonshire (NGR SP 725 635). Sixteen evaluation trenches were excavated targeted on known or suspected features and settlements. At the western side of the site the cropmarks of Sites 9 and 13 were demonstrated as being geological in origin. The linear cropmarks investigated by Trench 36 (Site 6) are also likely to be of natural origin. Sites 2 and 3 were confirmed as being of middle Iron Age and Roman date as established by previous evaluation although further clarification of the character of these settlements was not possible within the scope of this evaluation. Likewise, assessment of the causewayed enclosure was beyond the scope of this investigation although a curving ditch excavated within Trench 37 appears to respect the southern boundary of this monument. With the exception of Trench 35, significant plough truncation does not appear to have occurred within the excavated trenches.

**Location of archive:** The archive is currently held at OA, Janus House, Osney Mead, Oxford, OX2 0ES. Northampton does not currently have a receiving museum.



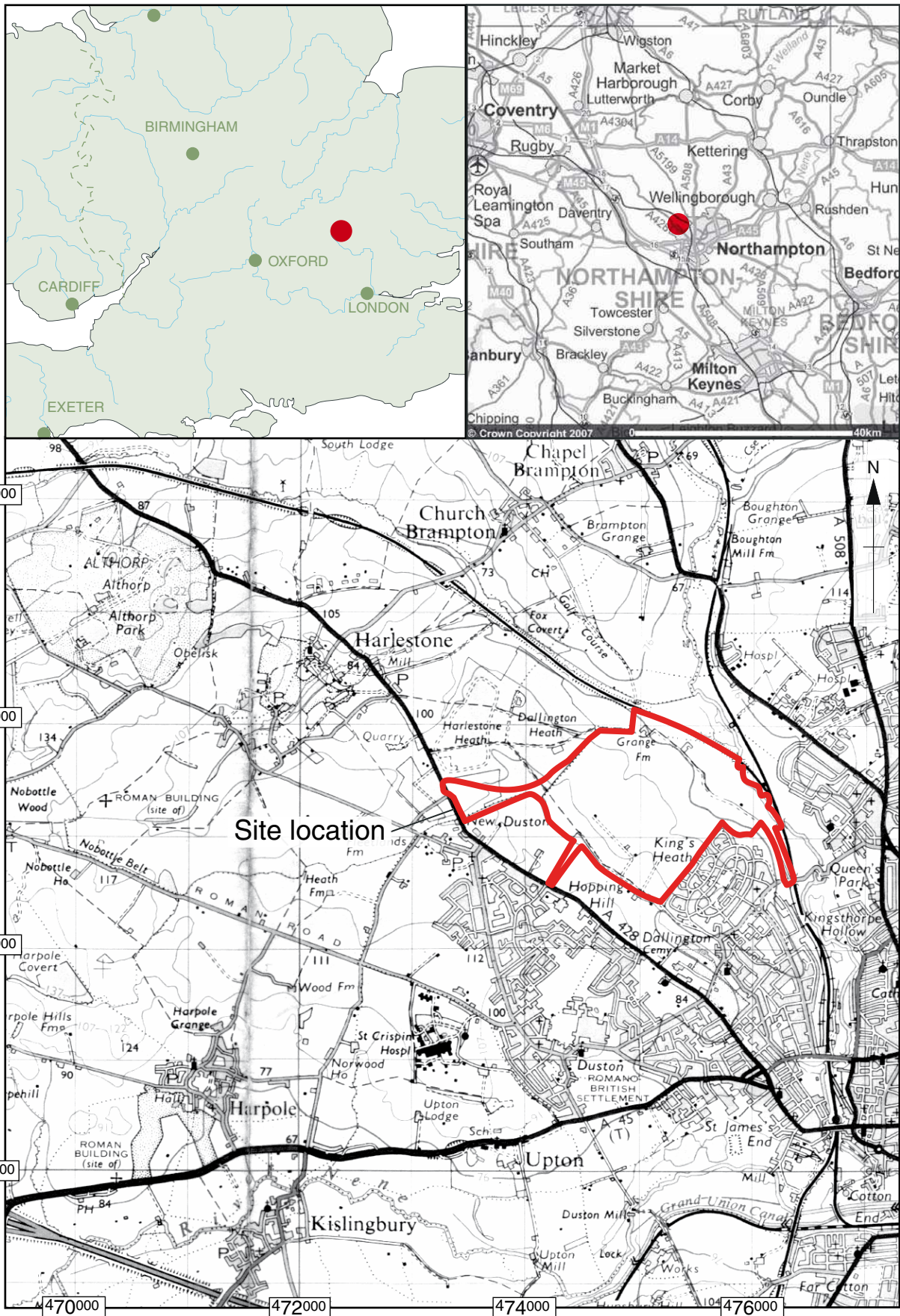

Reproduced from the Landranger 1:50,000 scale by permission of the Ordnance Survey on behalf of The Controller of Her Majesty's Stationery Office  
© Crown Copyright 1974. All rights reserved. Licence No. AL 10005569

Figure 1: Site location



X:\DALGREY\_Dallington\_Grange\_Norhampton\010\comatics\CAD\001\current\DALGREY\_figure02.dwg\*DALGREY\*Dallington\_Grange\*GJ\*19.06.07

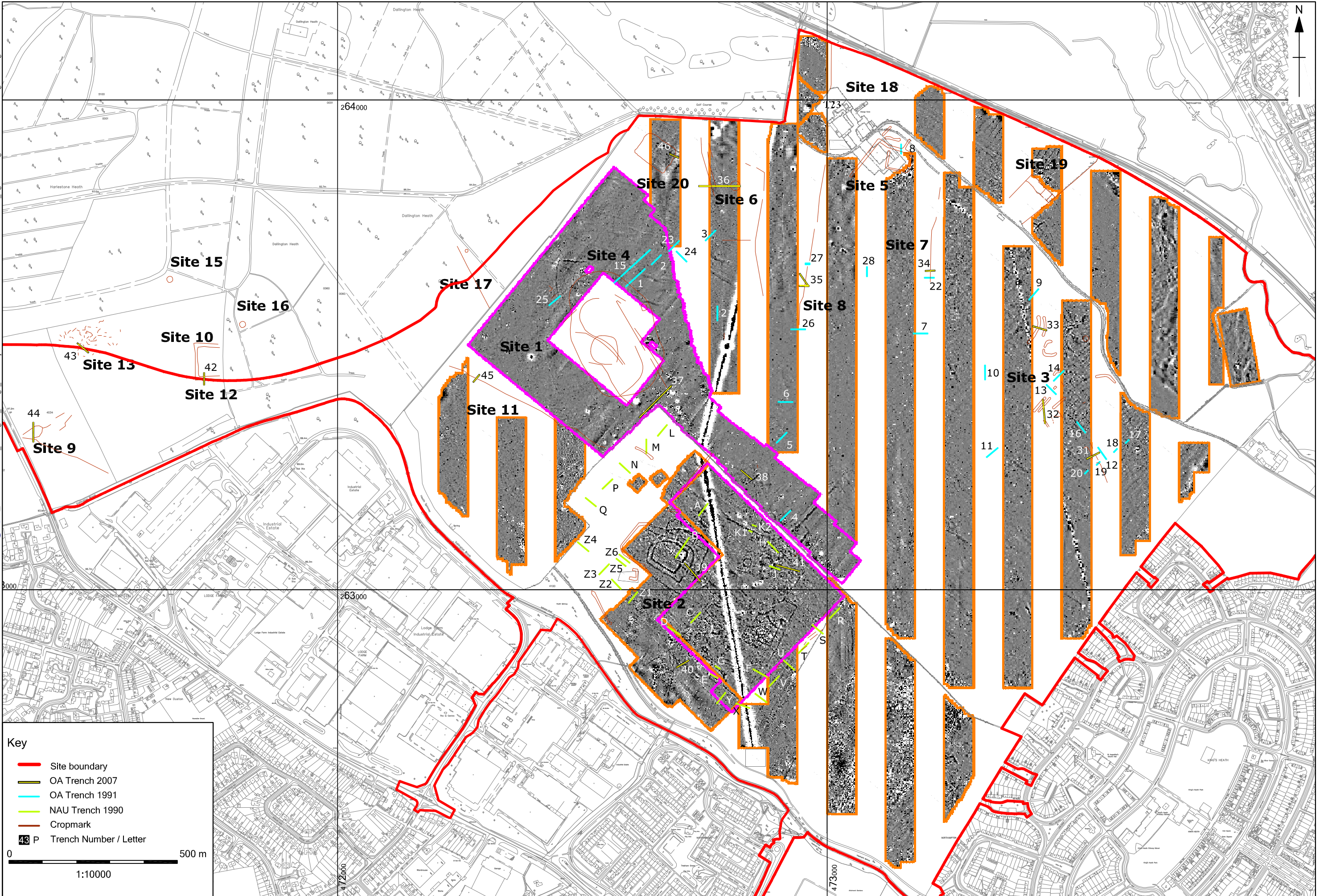

**Key**

- Site boundary
- OA Trench 2007
- OA Trench 1991
- NAU Trench 1990
- Cropmark
- 43 P Trench Number / Letter

0 500 m  
1:10000

Figure 2: Summary location plan of the current and previous investigations



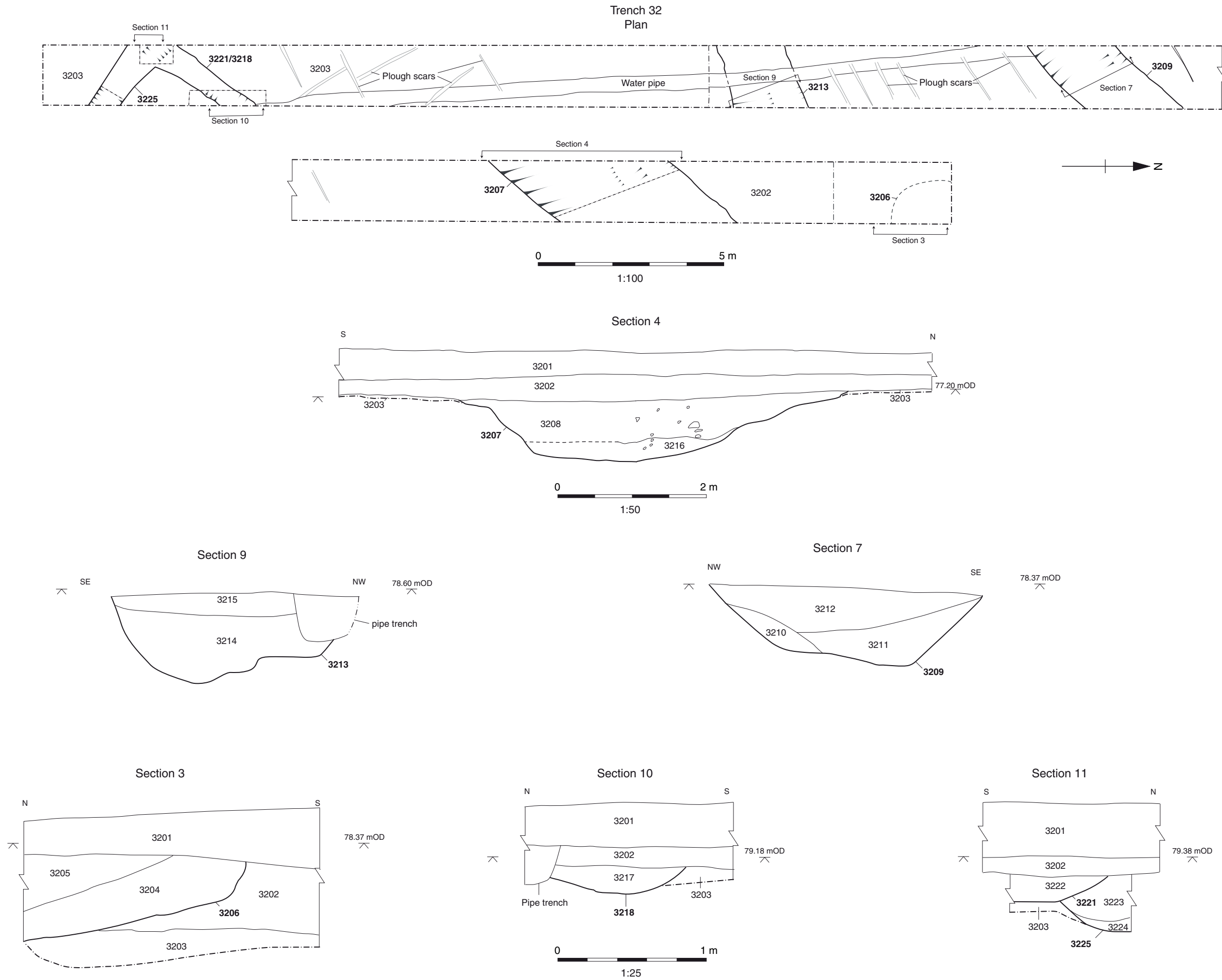
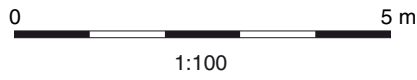
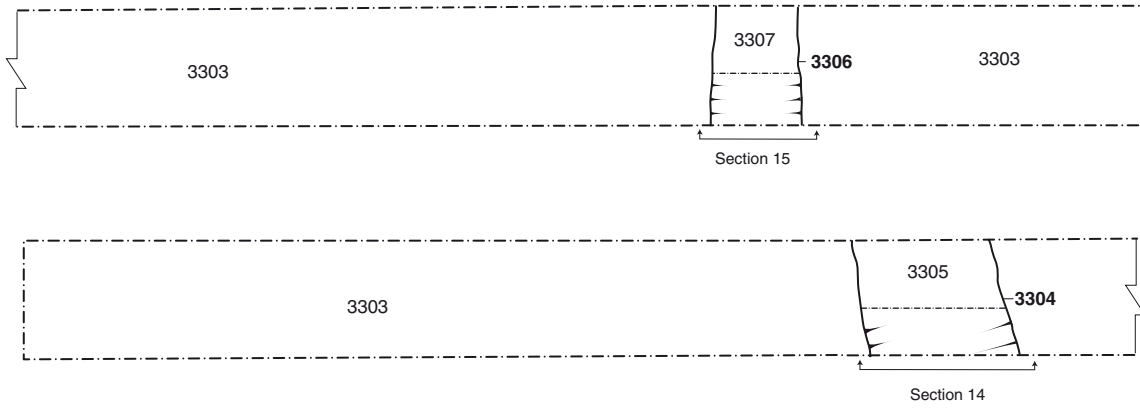
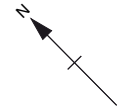
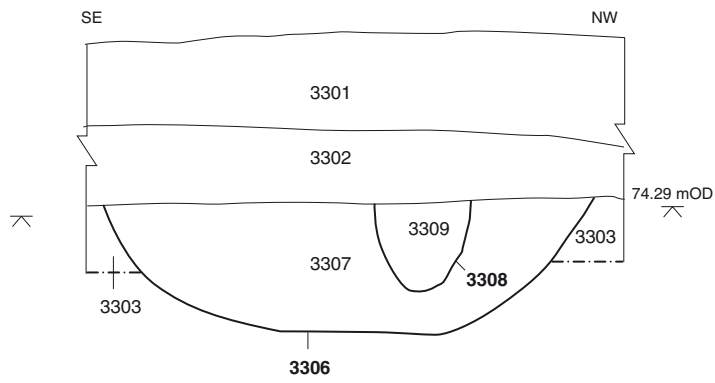

Figure 3: Trench 32, plan and sections

### Trench 33 Plan



#### Section 15



#### Section 14

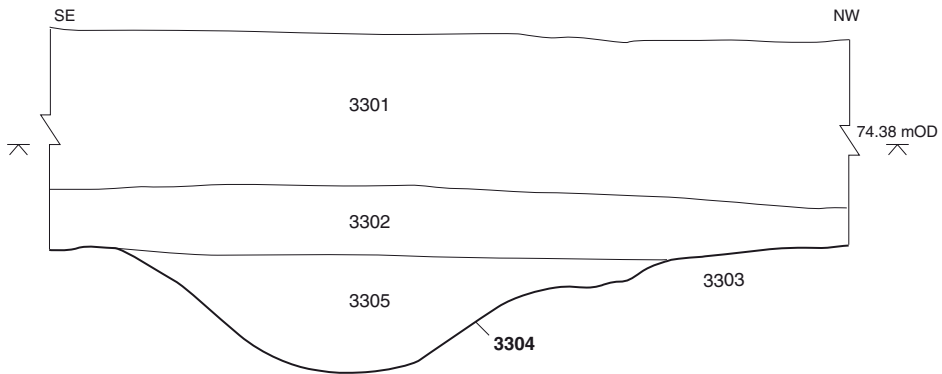
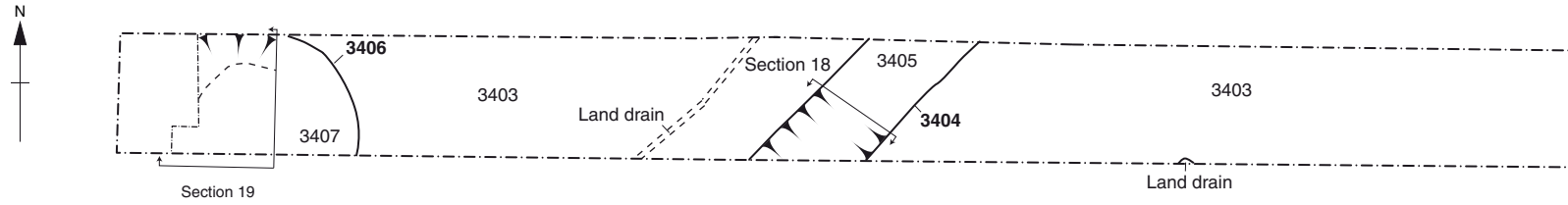

Figure 4: Trench 33, plan and sections

### Trench 34 Plan



### Section 18



### Section 19

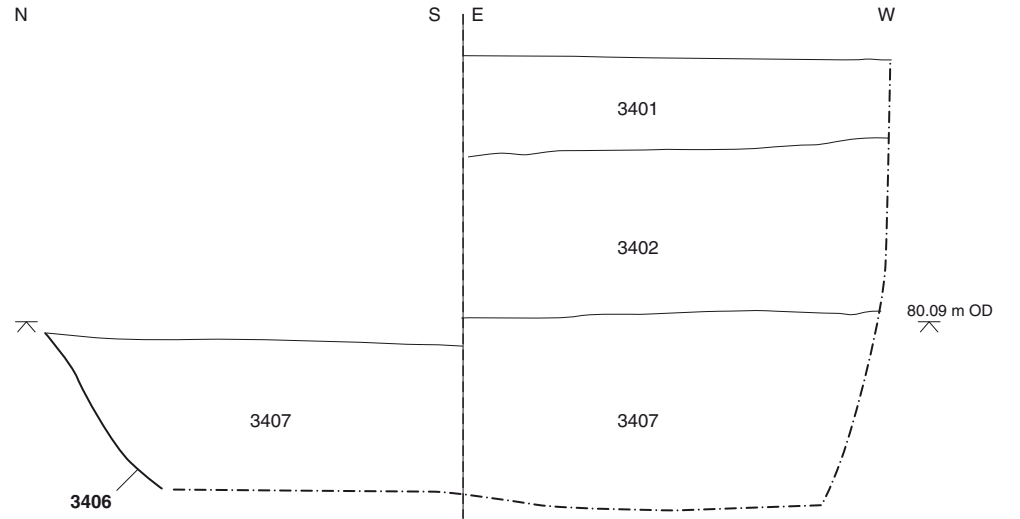

Figure 5: Trench 34, plan and sections

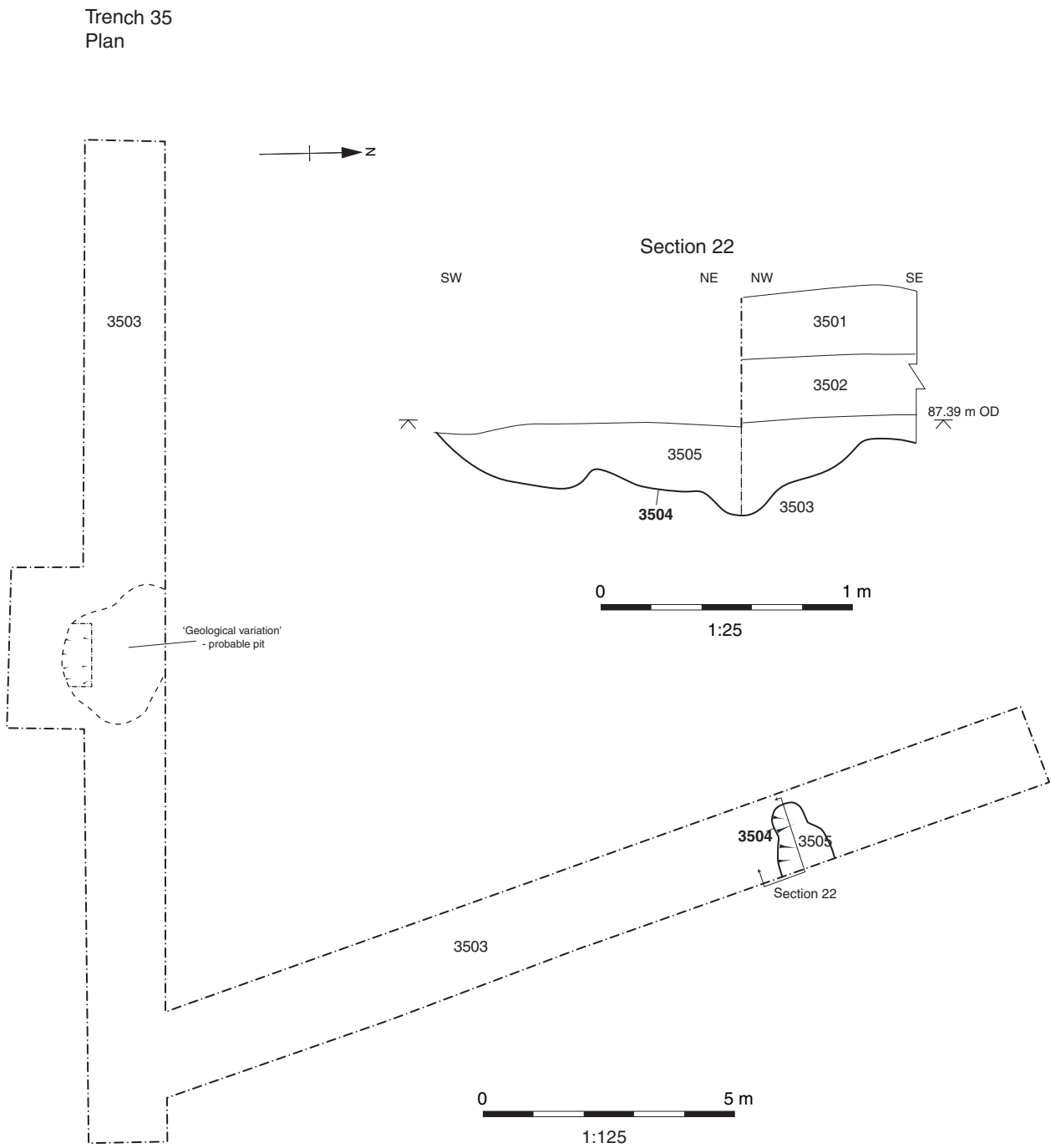

Figure 6 : Trench 35, plan and section

### Trench 37 Plan

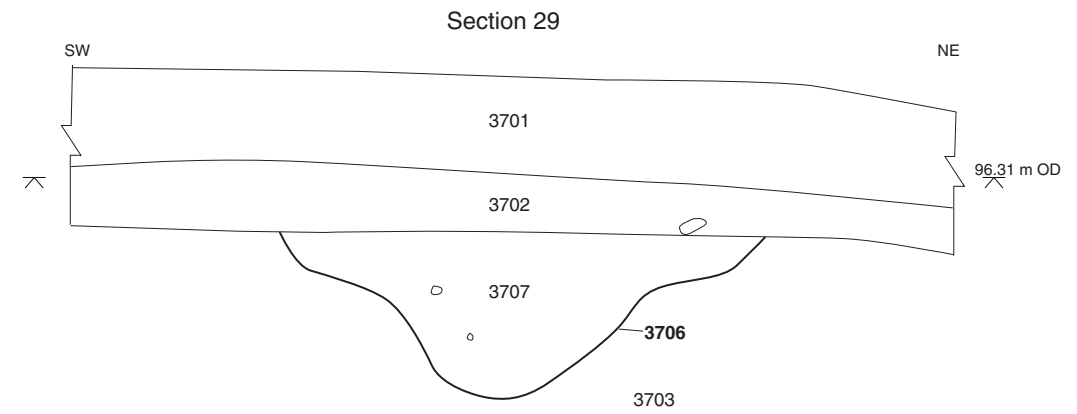
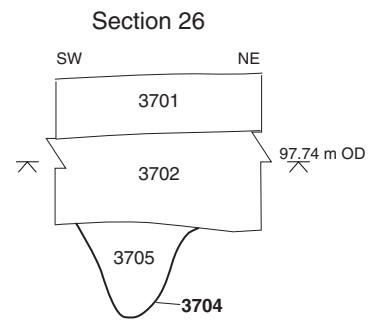
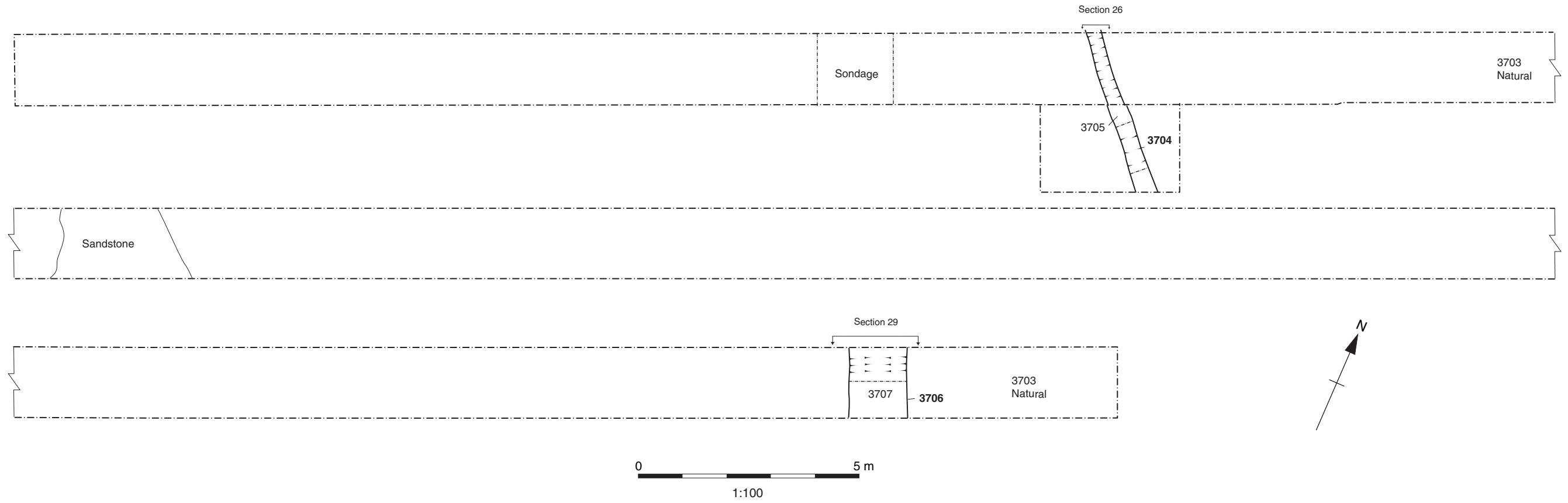
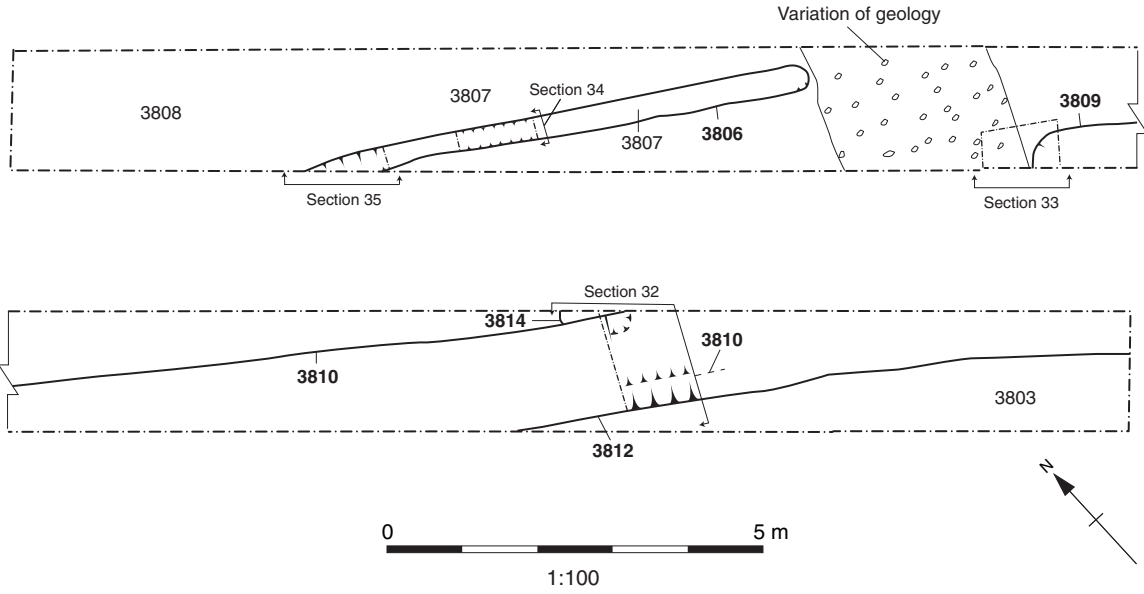
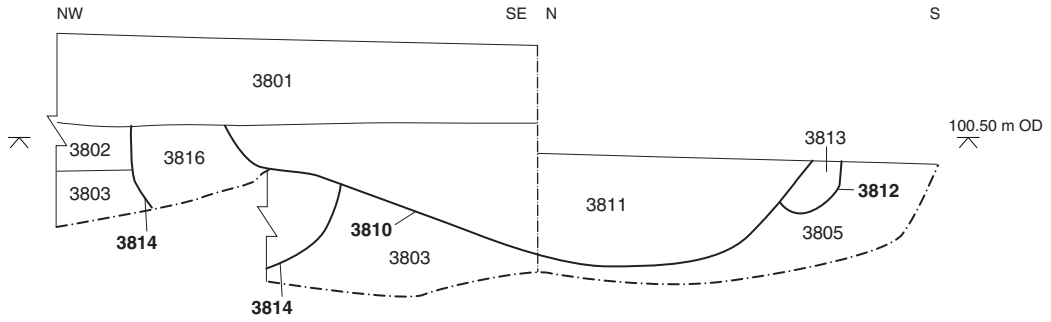

Figure 7 : Trench 37, plan and sections

### Trench 38 Plan



### Section 32



### Section 33

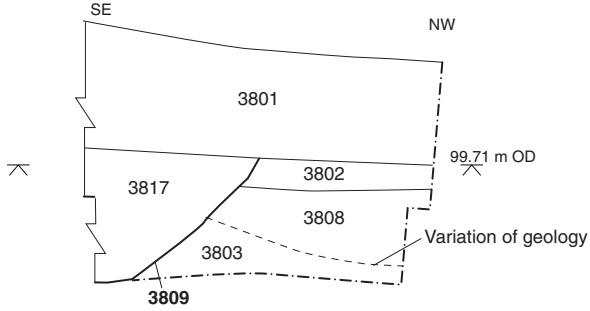

### Section 34

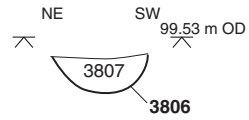

### Section 35

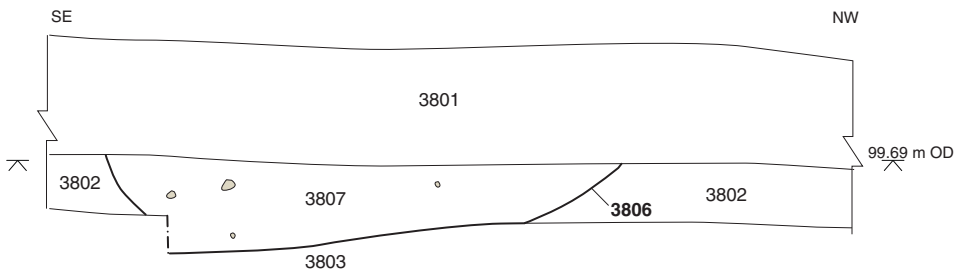

 Sandstone



Figure 8: Trench 38, plan and sections



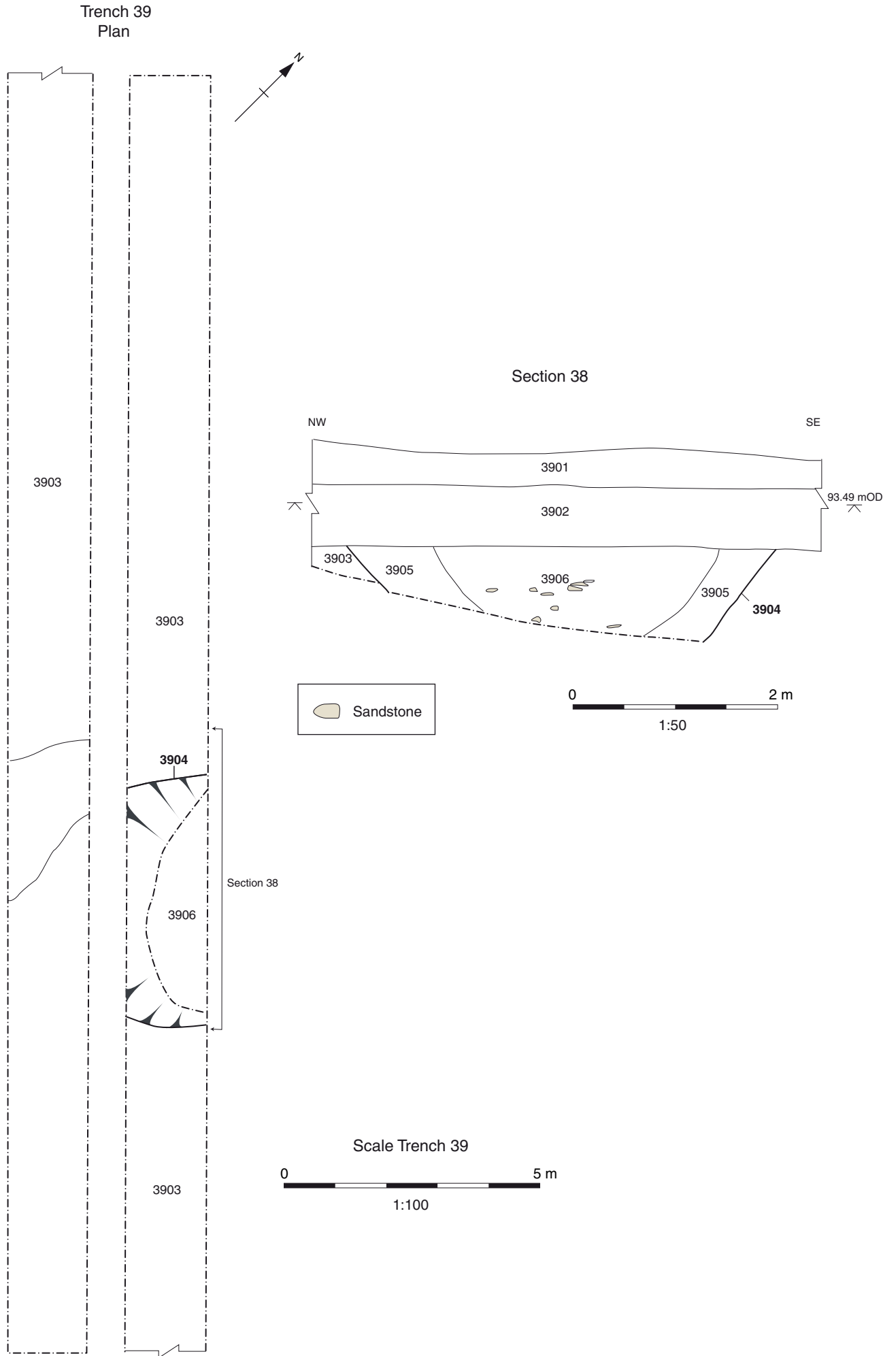

Figure 9: Trench 39, plan and section

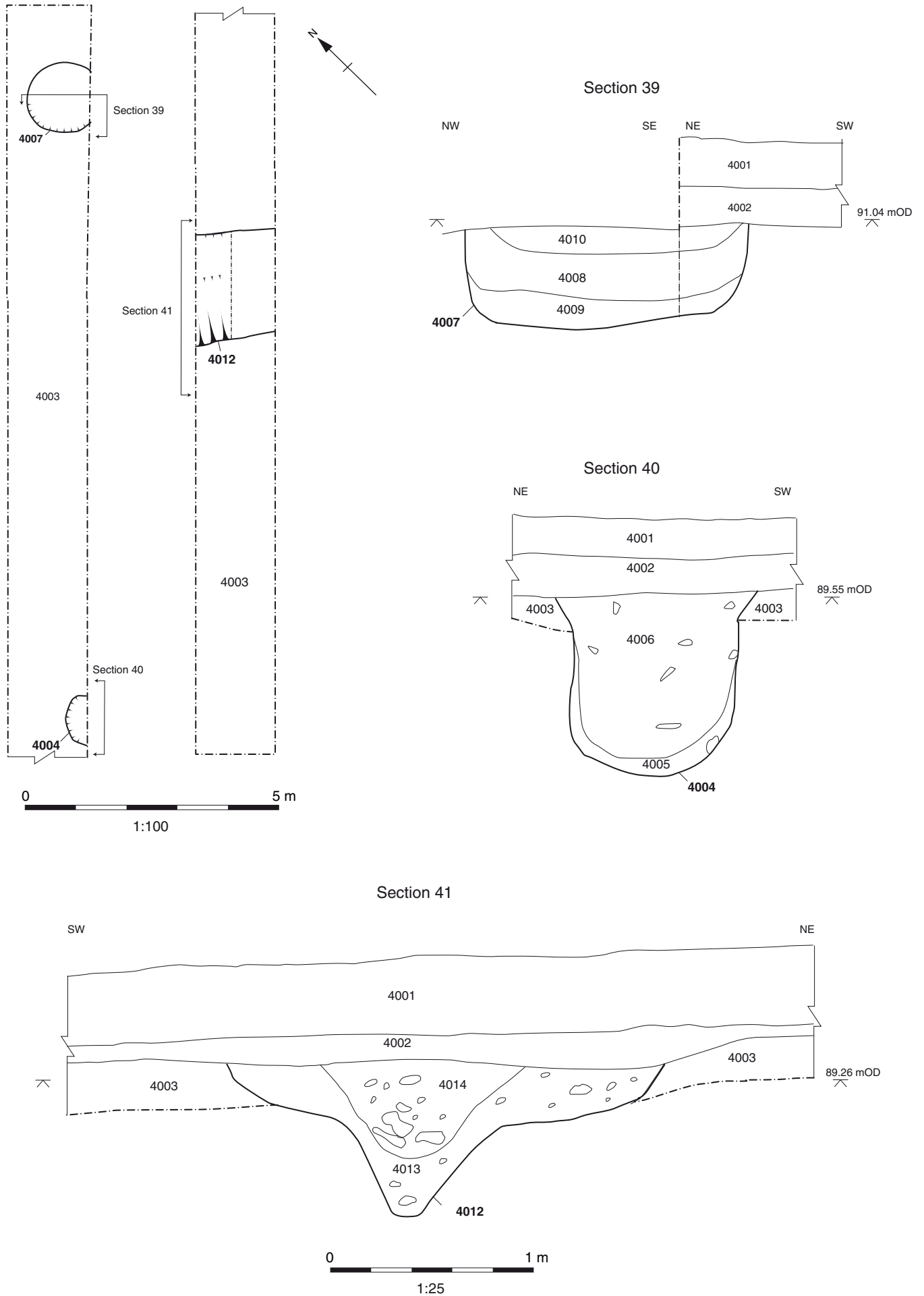

Figure 10: Trench 40, plan and sections

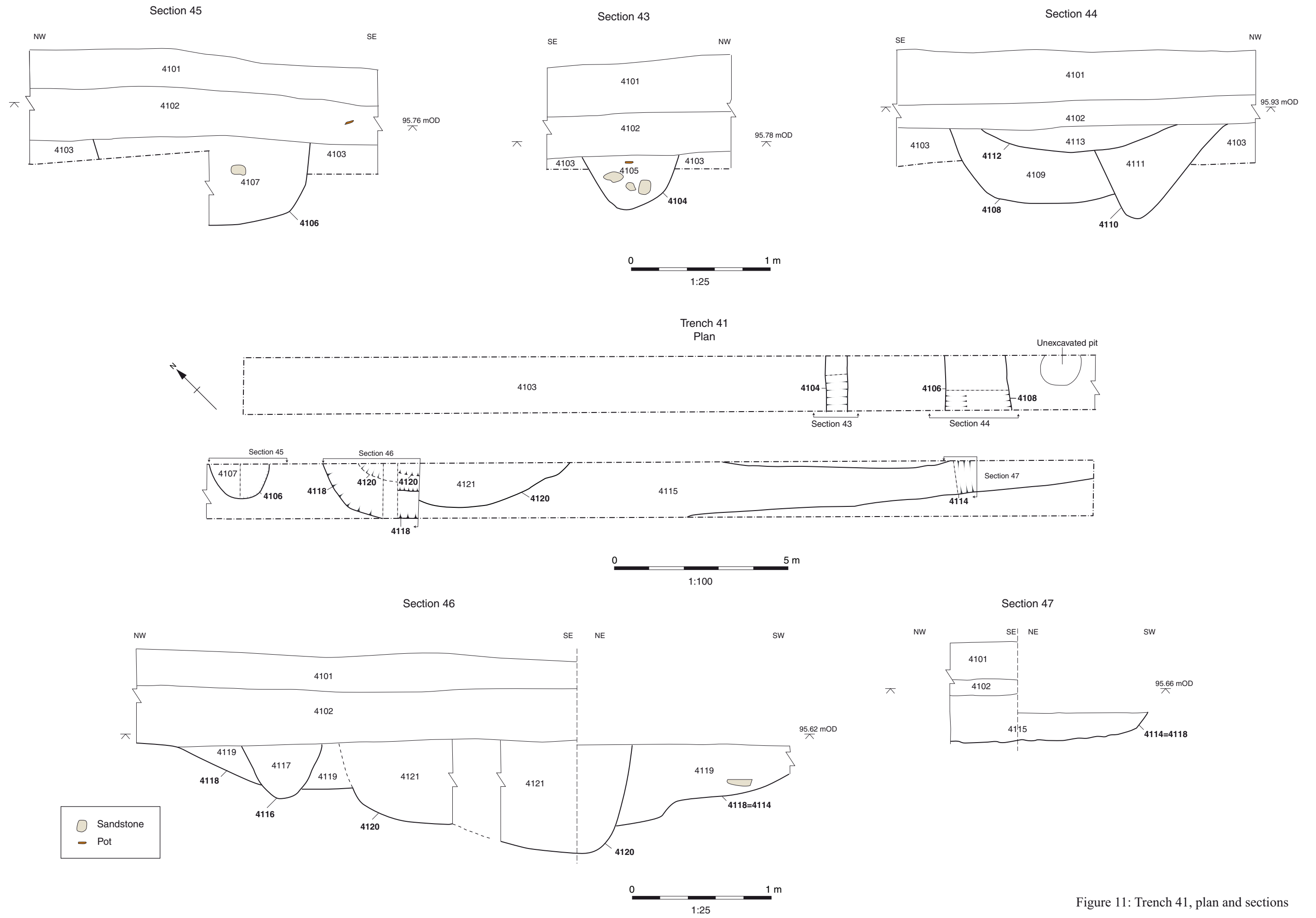

Figure 11: Trench 41, plan and sections

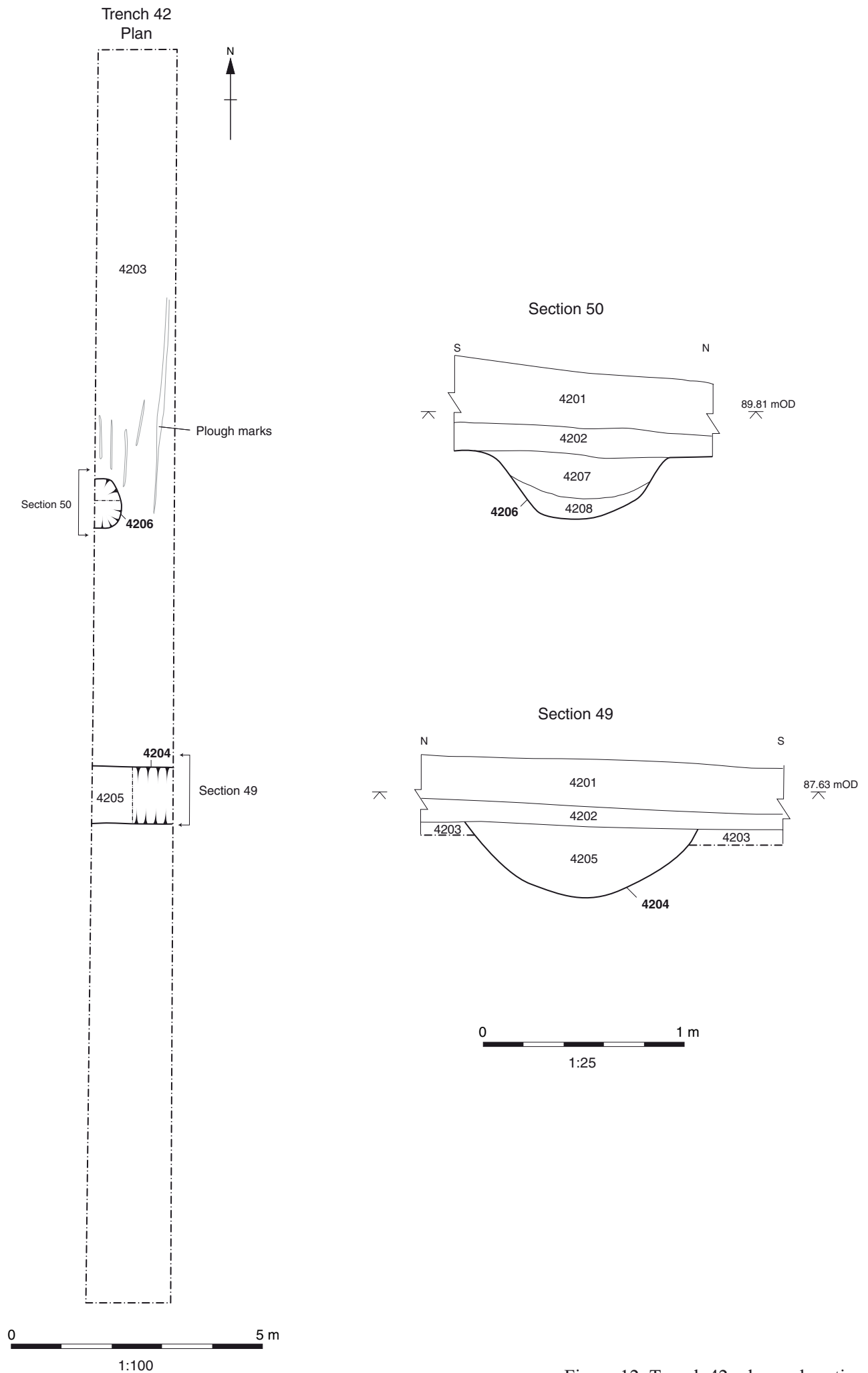

Figure 12: Trench 42, plan and sections

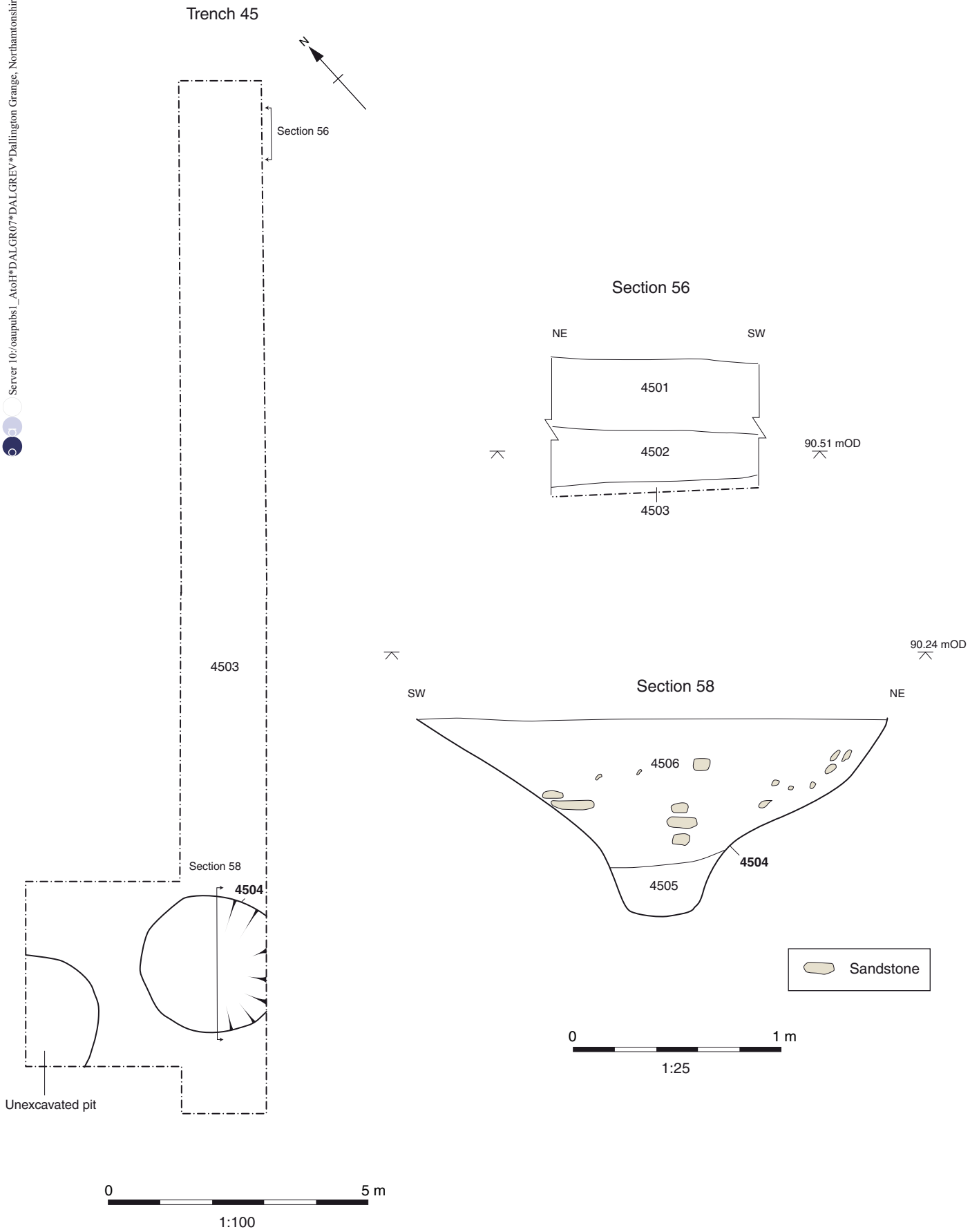
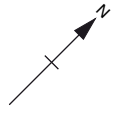
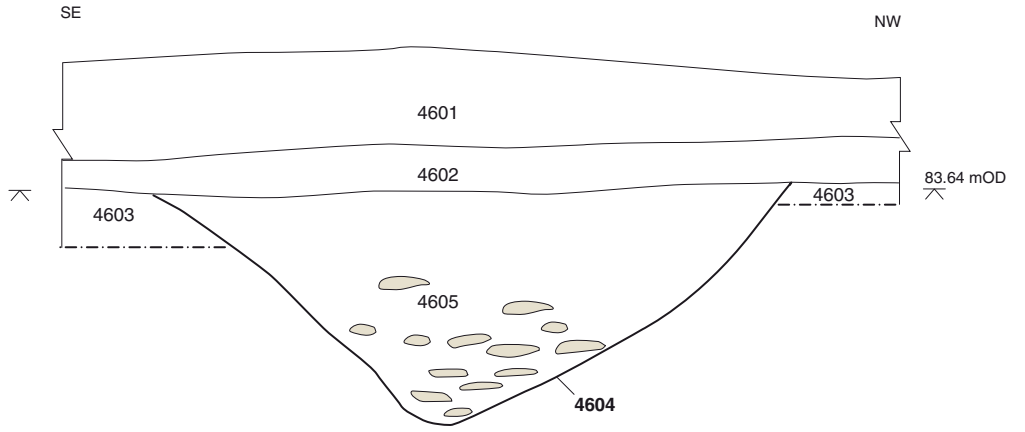

Figure 13: Trench 45, plan and sections

### Trench 46 Plan



### Section 60



### Section 61

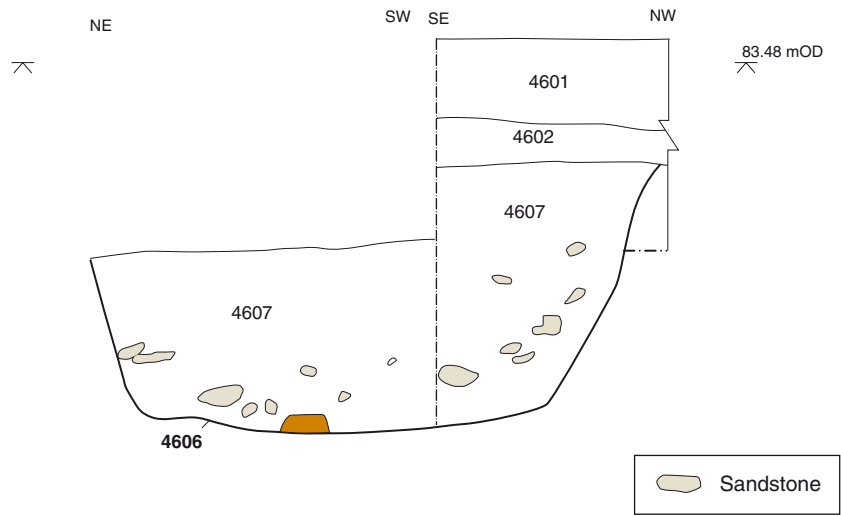

Figure 14: Trench 46, plan and section



### **Oxford Archaeology**

Janus House  
Osney Mead  
Oxford OX2 0ES

t: (0044) 01865 263800  
f: (0044) 01865 793496  
e: [info@oxfordarch.co.uk](mailto:info@oxfordarch.co.uk)  
w: [www.oxfordarch.co.uk](http://www.oxfordarch.co.uk)



### **Oxford Archaeology North**

Storey Institute  
Meeting House Lane  
Lancaster LA1 1TF

t: (0044) 01524 848666  
f: (0044) 01524 848606  
e: [lancinfo@oxfordarch.co.uk](mailto:lancinfo@oxfordarch.co.uk)  
w: [www.oxfordarch.co.uk](http://www.oxfordarch.co.uk)



**Director:** David Jennings, BA MIFA FSA

Oxford Archaeological Unit is a  
Private Limited Company, N<sup>o</sup>: 1618597  
and a Registered Charity, N<sup>o</sup>: 285627

**Registered Office:**

Oxford Archaeological Unit  
Janus House, Osney Mead, Oxford OX2 0ES